

BUSH - CD Micro System for iPod/iPhone

Installation & User Instructions – Please keep for future reference

141/8419(D)

BUSH

Real Life Technology

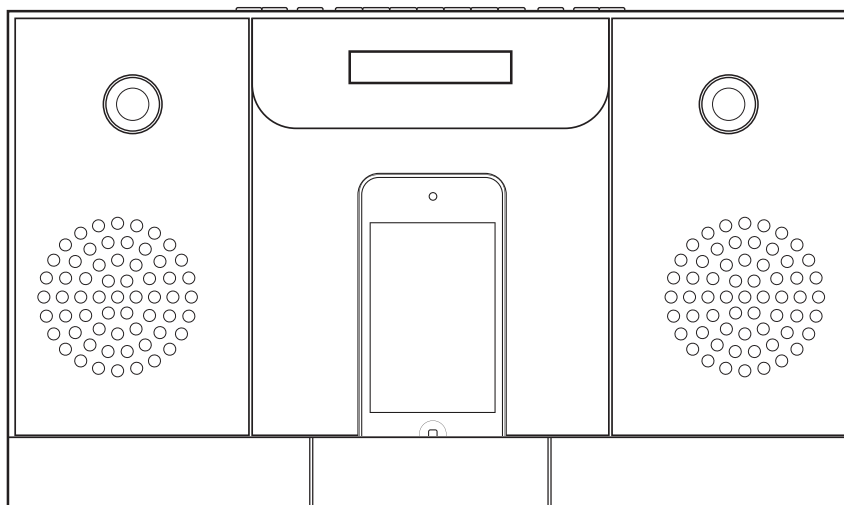

Important – Please read these instructions fully before installing or using

These instructions contain important information which will help you get the best from your appliance and ensure safe and correct installation, use and maintenance.

If you need help or have damaged or missing parts, call the **Customer Helpline: 0870 600 3030**

Table of contents

Safety Warnings	2
Disc handling	2
Accessories included.....	3
Overview of controls.....	3
Power supply.....	4
Setting the clock	4
Setting the alarms	4
Snooze function.....	4
Sleep function.....	5
Setting the volume level.....	5
Mute function	5
Basic CD operation.....	5
Skipping tracks	5
Searching tracks	5
Repeat & random function	5
Program function	5
Radio function	6
Radio station presets	6
iPod/iPhone connection.....	6
Aux input mode	7
EQ modes	7
Remote control battery replacement.....	7
Care & maintenance	8
Troubleshooting.....	8
Technical specifications.....	9

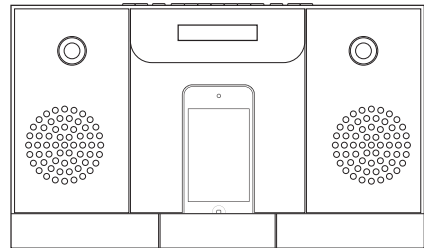

Product Codes

CMC111i

Safety information

Important – Please read these instructions fully before installation

Safety Warnings

CAUTION: TO REDUCE THE RISK OF ELECTRIC SHOCK, DO NOT REMOVE ANY COVER. NO USER-SERVICEABLE PARTS INSIDE, REFER ANY SERVICING TO QUALIFIED SERVICE PERSONNEL.

Please read this owner's guide

- Please take the time to follow the instructions in this owner's guide carefully. It will help you set up and operate your system properly and enjoy all of its advanced features.
- Please save this owner's guide for future reference.
- The product label is located on the back of the product.
- This product must be used indoors. It is neither designed nor tested for use outdoors, in recreation vehicles, or on boats.
- Heed all warnings - on the product and in the owner's guide.
- Do not use this apparatus near water or moisture.
- Do not use this product near a bathtub, washbowl, kitchen sink, and laundry tub, in a wet basement, near a swimming pool, or anywhere else that water or moisture is present.
- Only use attachments/accessories specified by the manufacturer.
- Unplug this apparatus during lightning storms or when unused for long periods of time - to prevent damage to this product.
- Refer all servicing to qualified service personnel
- Servicing is required when the apparatus has been damaged in any way: such as liquid has been spilled or objects have fallen into the apparatus; the apparatus has been exposed to rain or moisture, does not operate normally, or has been dropped -
- Do not attempt to service this product yourself.
- Opening or removing covers may expose you to dangerous voltages or other hazards.
- To prevent risk of fire or electric shock, avoid overloading wall outlets, extension cords, or integral convenience receptacles.
- Use proper power sources - Plug the product into a proper power source, as described in the operating instructions or as marked on the product.
- The mains plug is used as the disconnect device, the disconnect device shall remain readily accessible



 This symbol means that this unit is double insulated. An earth connection is not required.

CAUTION : CLASS 1 LASER PRODUCT

Use of contents or adjustments of performance of procedures other than those specified Herein may result in hazardous radiation exposure.



LASER SAFETY

This unit employs a laser, only qualified service personnel should attempt repair.

DANGER: Invisible laser radiation when open and interlock failed or defeated avoid direct exposure to beam.

CAUTION: hazardous laser radiation when open and intelock defeated.

Disc handling

Do not touch the playback side of the disc.
Do not attach paper or tape to disc.



Fingerprints and dust on the disc cause picture and sound deterioration. Wipe the disc from the centre outwards with a soft cloth. Always keep the disc clean.



- If you cannot wipe off the dust with a soft cloth, wipe the disc lightly with a slightly moistened soft cloth and finish with a dry cloth.
- Do not use any type of solvent such as thinner, benzene, commercially available cleaners or antistatic spray for vinyl. It may damage the disc.
- Do not store discs in a place subject to direct sunlight or near heat source.
- Do not store discs in a place subject to moisture and dust such as a bathroom or near a humidifier.
- Store discs vertically in a case, stacking or placing object on discs outside or their case may cause warping.

Functions & controls

Please familiarize yourself with the parts and accessories listed below

Accessories included

- 1 x CMC111i
- 1 x Remote control (including 1 x CR2025)
- 1 x Mains adapter
- 1 x Instruction Manual

Overview of controls

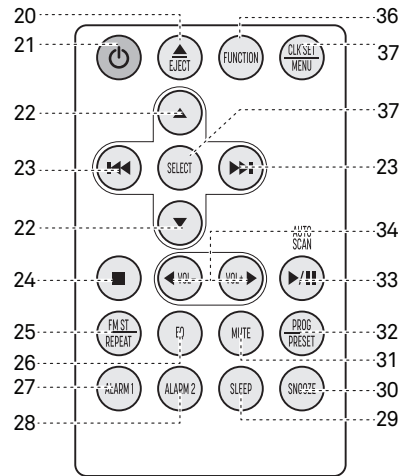
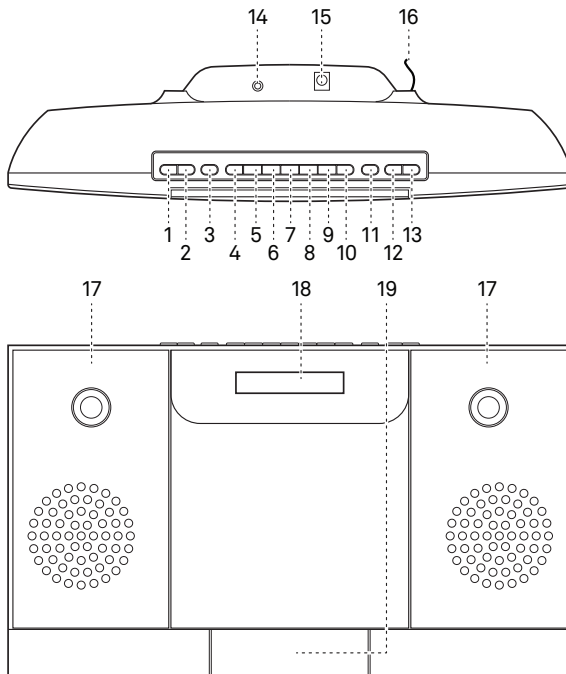

- | | |
|--|--|
| <ul style="list-style-type: none"> 1: SNOOZE/VOLUME - 2: SNOOZE/VOLUME + 3: STANDBY button 4: FUNCTION button 5: CLOCK SET button 6: SLEEP button 7: REPEAT/FM STEREO button 8: PROG./PRESET button 9: STOP/ALARM OFF button 10: PLAY/PAUSE button 11: EJECT button 12: SKIP ◀◀ button 13: SKIP ▶▶ button | <ul style="list-style-type: none"> 14: AUX input 15: DC power input 16: Antenna 17: Speakers 18: LCD display 19: iPod/iPhone dock 20: EJECT button 21: STANDBY button 22: NAVIGATION ▲/▼ buttons 23: SKIP ◀◀/▶▶ buttons 24: STOP button 25: FM STEREO/REPEAT button 26: EQ button 27: ALARM 1 button 28: ALARM 2 button 29: SLEEP button 30: SNOOZE button 31: MUTE button 32: PROG./PRESET button 33: PLAY/PAUSE/AUTOSCANNING button 34: VOLUME +/- buttons 35: CLOCK SET/MENU button 36: FUNCTION button 37: SELECT button |
|--|--|

User instructions

Power supply

Mains Power Using the supplied AC adaptor

- 1: Connect the mains adaptor to a **UK** mains outlet.
- 2: Connect the adaptor plug into the rear mains socket (15).

NOTE: Please ensure you only use the supplied mains adaptor with this unit.

- 3: When the power is connected the unit will be in **STANDBY** mode. You will need to press the **STANDBY** button (3), or (21) on the remote to wake up the unit.
- 4: To put the unit into standby mode, press the **STANDBY** button (3) or (21).

NOTE: This unit is designed to enter **STANDBY** mode automatically after **20 MINUTES** of inactivity. Press the **STANDBY** button to wake the unit.

Setting the clock

- 1: Ensure the unit is in **STANDBY** mode by pressing the **STANDBY** button. If you see only '0:00' then you are in the correct mode.

NOTE: If the time has been set previously the display will not show '0:00' but the time from the original setting.

- 2: Press and hold the **CLK SET** button (5), or (35) on the remote to enter the clock setting menu.



- 3: Set the hour digits by pressing either of the **◀▶** buttons (12,13/23). Once the hour has been set press the **CLK SET** button again to move onto the minute setting. Use the same process to set the minutes.
- 4: When set press the **CLK SET** button once more to store the setting.

NOTE: the clock is set in 24hr mode only.

Setting the alarms

This unit is equipped with two independent alarms. The following steps will assume the clock has been set already and the unit is in **STANDBY** mode.

Setting Alarm 1/2 from the remote control

- 1: Press and hold the **ALARM 1** or **ALARM 2** button (27,28) to initiate the alarm setting function. You will see the corresponding alarm icon appear on the display and the hour digit will flash.
- 2: Set the hour digits by pressing either of the **◀▶** buttons (12,13/23). Once the hour has been set press the **ALARM 1** or **2** button again to move onto the minute setting. Use the same process to set the minutes. Press the **ALARM 1** or **2** button once more to complete the time setting.

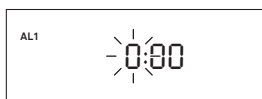

- 3: You will now see **BU** appear on the display. Use the **◀▶** buttons to select from **BU** (buzzer), **CD, RAD** (radio) or **IPOD**. The **CD, RADIO & IPOD** alarm volume level is set using the **VOLUME+/-** buttons (1,2/34).

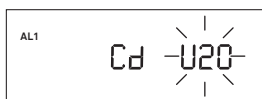

- 4: Press the **ALARM 1** or **2** button to complete the alarm setting.
- 5: To activate or deactivate an alarm press the relevant alarm button eg:- **ALARM 1** or **2** (27, 28).

NOTE: Pay attention to the alarm icons on the display. If the icon is not present the alarm is inactive.

- 6: To disable the alarm when sounding press the **STOP/AL OFF** button (9), or press either **ALARM 1** or **2** button.

Snooze function

Should you wish to delay the alarm for 9 minutes you can activate the **SNOOZE** function.

- 1: When the alarm sounds press either **SNOOZE** button (1,2,30) to delay the alarm for 9 minutes.
- 2: After one hour of snoozing the **SNOOZE** function will no longer operate.

User instructions

Sleep function

Should you wish to set a timer for the unit to enter standby mode after a period of time follow the steps below.

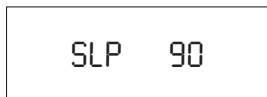

- 1: Ensure the unit is **ON** and not in **STANDBY**.
- 2: Press the **SLEEP** button (6, 29) repeatedly to cycle through the preset timers from **90** minutes to **10** minutes then **OFF**.
- 3: When you have selected the required timer duration, after **1** second of inactivity the setting will be stored and the countdown will begin.

Setting the volume level

- 1: To increase the volume level press the **VOL+** button (2,34). To decrease the volume level press the **VOL-** button (1,34).

Mute function

- 1: Press the **MUTE** button (31) on the remote control to temporarily silence audio playback. You will see the letter '**M**' appear on the display to indicate **MUTE** is active.
- 2: Press the **MUTE** button once more to enable audio playback again.

Basic CD operation

- 1: Press the **FUNCTION** button (4,36) repeatedly until you see '**Cd**' appear on the top of the display.
- 2: Press the **EJECT** button (11,36) to open the **CD** door. Load a **CD** with the label facing outwards and press the **EJECT** button again to close the door. The **EJECT** function only operates in **CD** mode.

NOTE: You may need to angle the disc and slide the top half into the unit before mounting the disc on the mechanism.

DO NOT push the door downwards to close.

Basic CD operation (cont)

- 3: Once loaded the unit will read the disc contents and begin playback. Pause playback by pressing the **PLAY/PAUSE** button (10,33) once. To resume playback press the **PLAY/PAUSE** button again.
- 4: To stop playback press the **STOP** button (9,24).



Skipping tracks

- 1: Press the **SKIP▶▶▶** button (13,23) to skip to the next track on the disc.
- 2: Press the **SKIPI◀◀◀** button (12,23) to skip to the previous track

Searching tracks

- 1: Press and hold the **SKIP▶▶▶** button (13,23) to fast forward the current track playing.
- 2: Press and hold the **SKIPI◀◀◀** button (12,23) to fast rewind the current track playing.

Repeat & random function

- 1: Press the **REPEAT** button (25) once to repeat the current track. You will see  flash on the top right portion of the display.
- 2: Press the **REPEAT** button again to repeat the entire disc. You will see the  icon on the top right portion of the display stop flashing and remain solid.
- 3: Press the **REPEAT** button once more to enter **RANDOM** playback mode. This function will playback all tracks on the current disc in a random order. You will see '**RAN**' appear to the right of the time code.
- 4: Press the **REPEAT** button once more to cancel any repeat functions and resume normal playback. All icons will disappear.

Program function

You can program an alternative playback sequence for up to **20** tracks on a single disc.

- 1: First press the **STOP** button if a disc is playing.
- 2: Press the **PROG.** button (8,32). You will see '**PROG**' flash on the right of the display & **P-01** appear to indicate program mode operation.



User instructions

Program function (cont)

- 3: Press either **◀◀** / **▶▶** buttons to select the track number you wish to play in position one.
- 4: Press the **PROG.** button to store the track.
- 5: Repeat steps 3-4 until you have programmed all the tracks you wish to play.
- 6: Press the **PLAY/PAUSE** button to begin playback of your programmed sequence.
- 7: To delete the program press the **STOP** button twice. You will notice the 'PROG' icon disappears from the display.

Radio function

Before tuning the radio extend the antenna (16) fully.

- 1: Press the **FUNCTION** button (4,36) repeatedly until you see a radio frequency appear on the display
EG:- 89.60.
- 2: To manually scan for radio stations press and hold either of the **◀◀** / **▶▶** buttons (12,13,23) for two seconds to scan down or up the frequency band. When a station is found the scan will stop and the station will begin to play.
- 3: To fine tune the frequency press either of the **◀◀** / **▶▶** buttons (**do not press & hold**), to jump **0.05 MHz.**
- 4: There is an auto scan function that will scan the entire frequency range and store all located stations in the preset memory slots. To use this function press and hold the **AUTOSCAN** button on the remote (33). The unit will scan the frequency band and stop when finished. See '**Radio station presets**' below for details on how to recall located stations.

NOTE: Placement of the aerial is important to get a good FM signal. If you are having problems tuning a station, moving the aerial may improve the reception. If not try moving the unit to another location.

- 5: If you are experiencing poor stereo **FM** reception, you can press the **FM ST.** button (7,25) to revert to **MONO** mode which can clean up the reception. Stereo mode is indicated by this icon .

NOTE: Not all stations will allow this function.

Radio station presets

It is possible to store up to 20 preset stations. The below steps will explain how to store & recall them.

- 1: With a radio station tuned, press and hold the **PRESET** button (8,32). You will see a **P01** flash on the display to indicate preset **01**.
- 2: If you wish to store the current station in slot **01** press the **PRESET** button again to store. Should you wish to use another slot use the **NAVIGATION ▲ / ▼** buttons (22) to cycle through slots **1-20** until you reach the slot you wish to use.
- 3: Press the **PRESET** button to store the station in the selected slot.
- 4: To recall stations stored in preset slots use the **NAVIGATION ▲ / ▼** buttons (22) to cycle through slots **1-20**. Each press will play the stored station on that slot. If no station is stored then static will be heard.

iPod/iPhone connection

To dock a compatible iPod / iPhone in the unit follow the below steps.

- 1: Push the iPod/iPhone docking tray (19) in until you hear a click. The tray will then pop out when released, push in again to hide the dock. Insert a compatible iPod/iPhone into the dock taking care when inserting the **30** pin adapter.

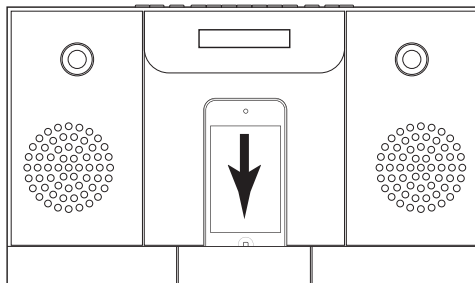

- 2: Press the **FUNCTION** button (4,36) repeatedly until you see an '**IP**' icon appear on the top of the display.

NOTE: When an iPod or iPhone is not docked and the function is set to '**IP**' the text will flash.

- 3: The connected iPod/iPhone will begin to play automatically.

User instructions

iPod/iPhone connection (cont)

- 4: To pause playback press the **PLAY/PAUSE** button. To stop playback press the **STOP** button.
- 5: Press the **SKIP** button (**13,23**) to skip to the next track on the disc. Press the **SKIP** button (**12,33**) to skip to the previous track
- 6: Press the **REPEAT** button (**25**) repeatedly to cycle the **REPEAT** playback options on your iPod/iPhone.
- 7: Press & Hold the **REPEAT** button to cycle the **SHUFFLE** playback options on your iPod/iPhone.
- 8: You can navigate the iPod/iPhone menus by pressing the **CLK SET/MENU** button (**35**) to change menu. The **NAVIGATION** ▲ / ▼ buttons (**22**) scroll up and down the menu options, and the **SELECT** button (**37**) to access the selected option.

NOTE: When docked a compatible iPod or iPhone will be charged.

NOTE: IOS 7 no longer supports the following remote functions (Navigation UP /DOWN, SELECT & MENU).

Aux input mode

You can connect an audio devices to the unit using a 3.5mm audio cable (not supplied).

- 1: Connect the 3.5mm plug (not supplied) into the **AUX** socket on the rear of the unit (**14**).

MP3 PLAYER

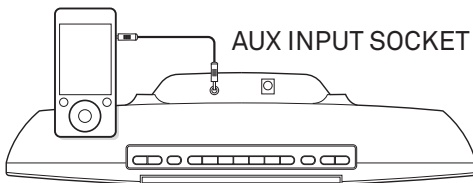

- 2: Connect the other end to your audio device.
- 3: Press the **FUNCTION** button (**4,36**) repeatedly until you see **AU** appear on the display.
- 4: Power on the external audio device and begin playback.
- 5: Adjust the volume on the **CMC111i** unit.

Aux input mode (cont)

NOTE: it is recommended to try various volume levels on the external audio device until you reach an acceptable balance. Too much volume and the audio will be distorted, too little and the audio will be too weak. The actual volume level is controlled on the **CMC111i** unit, using the **VOL + / -** buttons.

EQ modes

You can change the EQ levels to adapt to the type of audio you are listening to.

- 1: Press the **EQ** button (**26**) repeatedly to cycle through the available options of: **FLAT**, **ROCK**, **CLASSIC**, **POP** & **JAZZ**.

Remote control battery replacement

- Replace the remote control battery when it no longer operates the unit, or the range is reduced considerably.
- Use only **CR2025** 3V lithium batteries
- Bear in mind that lighting & other room conditions, in addition to battery age, can affect the operating range of an infrared remote control.

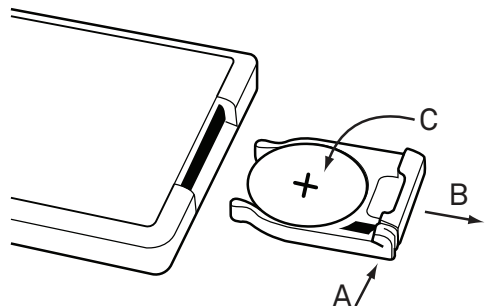

- 1: Press the tab on the bottom of the remote control inwards as shown (**A**).
- 2: Pull the battery compartment out (**B**).
- 3: Remove old battery and replace with the same type with the + facing upwards (**C**).
- 4: Push the battery compartment back inside the remote and close.

User instructions

Care & maintenance

 **Important:** Always unplug the appliance from the power socket during cleaning and maintenance.

Never use any sharp instruments or abrasive substances, soap, household cleaner, detergent or wax polish for cleaning.

Clean the external surfaces with a damp soft cloth only. Never use abrasive products or solvents as it may damage the appliance.

Troubleshooting

In the unlikely event of difficulties with your appliance please follow the trouble shooting guide below. If the problem persists, contact the retailer if the machine is still under guarantee.

Customer helpline: 0870 600 3030

Problem	Reason(s)	Solution(s)
No Power	<ul style="list-style-type: none">• Power cable not connected to wall socket• Power socket is not switched on	<ul style="list-style-type: none">• Make sure the plug is connected• Switch the power on
No Sound CD/AUX/RADIO/IPOD No Sound from AUX input	<ul style="list-style-type: none">• Volume is too low• iPod/iPhone not docked correctly• AUX source volume is too low	<ul style="list-style-type: none">• Increase the volume• Re-dock the iPod/iPhone• Increase the output volume of the AUX source.
Sound is distorted Sound is distorted from AUX input	<ul style="list-style-type: none">• Volume is too high• AUX source volume is too high	<ul style="list-style-type: none">• Reduce the volume• Reduce the output volume of the AUX source.
Unable to Play	<ul style="list-style-type: none">• No disc in the tray• Disc not loaded properly• Disc is dirty	<ul style="list-style-type: none">• Insert a compatible disc• Check the disc loaded• Clean the disc
Static Sound	<ul style="list-style-type: none">• Poor reception	<ul style="list-style-type: none">• Re-locate the antenna (FM)
Unit switches off after 20 minutes of inactivity	<ul style="list-style-type: none">• Auto standby mode in operation	<ul style="list-style-type: none">• This unit is designed to enter STANDBY mode automatically after 20 MINUTES of inactivity. Press the STANDBY button to wake the unit.

User instructions

Technical specifications

General	
Power	•Mains adaptor : 100-240V ~ 50/60Hz •Mains adaptor output : 10V DC 2000mA
Power Consumption	•20 Watts
Dimensions	•Approx. 350mm(L) x 110mm(W) x 205mm(H)
AUX In	•3.5mm stereo socket
Tuner	
FM	•87.5 - 108 MHz
CD Player	
Playback system	•Compact Disc Digital Audio System
DAC	•1 Bit DA converter with 8 x over sampling.
Frequency response	•100Hz - 12KHz (+/- 6 dB)
S/N ratio	•55dB
Dynamic range	•85dB
Audio	
Output Power	•3.5W x 2 (RMS)
Speaker impedance	•8 ohms
Disc Compatibility	
Disc Type	•CD-DA/CD-R/CD-RW
Size	•12cm & 8cm

Guarantee



PRODUCT GUARANTEE

This product is guaranteed against manufacturing defects for a period of



Year

This product is guaranteed for twelve months from the date of original purchase.

Any defect that arises due to faulty materials or workmanship will either be replaced, refunded or repaired free of charge where possible during this period by the dealer from whom you purchased the unit.

The guarantee is subject to the following provisions:

- The guarantee does not cover accidental damage, misuse, cabinet parts, knobs or consumable items.
- The product must be correctly installed and operated in accordance with the instructions contained in this manual.
- It must be used solely for domestic purpose.
- The guarantee will be rendered invalid if the product is re-sold or has been damaged by inexpert repair.
- Specifications are subject to change without notice.
- The manufacturer disclaims any liability for the incidental or consequential damages.
- The guarantee is in addition to, and does not diminish your statutory or legal rights.

Guarantor: Argos Limited
489 - 499 Avebury Boulevard
Central Milton Keynes
MK9 2NW