

Panasonic®

Operating Instructions
Bedienungsanleitung
Gebruiksaanwijzing
Mode d'emploi
Manuale di istruzioni
Instrucciones de funcionamiento
Manual de instruções
Instrukcja obsługi
Bruksanvisning
Brugsanvisning
Bruksanvisning
Käyttöohjeet
Návod k obsluze
Instrucțiuni de operare
Kezelési útmutató

Microwave Oven
Mikrowellengerät
Magnetron
Four à Micro-ondes
Forno a Microonde
Horno Microondas
Forno Micro-Ondas
Kuchenka Mikrofalowa
Kombinationsugn med Mikrovågor
Mikrobølgeovn
Mikrobølge
Mikroaaltouuni
Mikrovlinná trouba
Cuptor cu microunde
mikrohullámú sütő

NN-SD271S



English

Deutsch

Nederlands

Français

Italiano

Español

Svenska

Dansk

Norsk

Suomi

Polski

Česky

Magyar

Română

IMPORTANT SAFETY INSTRUCTIONS: Before operating this oven, please read these instructions carefully and keep for future reference.

WICHTIGE SICHERHEITSANWEISUNGEN. Bitte sorgfältig durchlesen und zur weiteren Bezugnahme aufbewahren.

BELANGRIJKE VEILIGHEIDSINSTRUCTIES. Lees ze a.u.b. zorgvuldig door en bewaar ze zodat u ze opnieuw kunt raadplegen wanneer nodig.

INSTRUCTIONS DE SÛRETÉ IMPORTANTES. Avant d'utiliser le four à micro-ondes, lisez attentivement les recommandations d'utilisation et conservez-les soigneusement.

ISTRUZIONI IMPORTANTI PER LA SICUREZZA. Leggere attentamente queste istruzioni e conservarle per consultazioni future..

INSTRUCCIONES SOBRE SEGURIDAD IMPORTANTES. Léalas detenidamente y guárdelas para futura referencia.

INSTRUÇÕES DE SEGURANÇA IMPORTANTES. Leia atentamente as instruções de segurança e guarde-as para futuras consultas.

WAŻNE INSTRUKCJE BEZPIECZEŃSTWA. Prosimy o dokładne zapoznanie się z instrukcją i zachowanie jej.

VIGTIGE SIKKERHEDSFORSKRIFTER. Læses omhyggeligt, og opbevares til senere brug.

VIKTIGE SIKKERHETSINSTRUKSJONER. Les nøye, og oppbevar på et trygt sted slik at du kan slå opp ved behov.

TÄRKEITÄ TURVALLISUUSTIETOJA. Lue nämä ohjeet huolellisesti ja säilytä ne myöhempää tarvetta varten.

VIKTIGA SÄKERHETSANVISNINGAR. Läs igenom anvisningarna noga och spara dem för framtida referens.

DŮLEŽITÉ BEZPEČNOSTNÍ POKYNY. Před uvedením trouby do provozu si laskavě pečlivě přečtěte tyto pokyny a uschovejte je pro budoucí použití.

INSTRUCȚIUNI DE SIGURANȚĂ IMPORTANTE: Înainte de utilizarea a acestui cuptor, vă rugăm să citiți cu atenție aceste instrucțiuni și să le păstrați pentru referințe ulterioare.

DŮLEŽITÉ POKYNY K BEZPEČNOSTI. Pečlivě si je prosím přečtěte a uložte pro případné použití.

- Important safety instructions. Before operating this oven, please read these instructions carefully and keep for future reference.
- This appliance can be used by children aged from 8 years and above and persons with reduced physical, sensory and mental capabilities or lack of experience and knowledge if they have been given supervision or instruction by a person responsible for their safety concerning the use of the appliance in a safe way and understand the hazards involved. Children shall not play with the appliance. Cleaning and user maintenance shall not be made by children without supervision. Keep the appliance and its cord out of reach of children less than 8 years.
- When this oven is installed, it should be easy to isolate the appliance from the electricity supply by pulling out the plug or operating a circuit breaker.

- If the supply cord is damaged, it must be replaced by the manufacturer or its service agent or a similarly qualified person in order to avoid a hazard.
- Warning! The appliance should be inspected for damage to the door seals and door seal areas and if these areas are damaged the appliance should not be operated until it has been repaired by a service technician trained by the manufacturer.
- Warning! Do not attempt to tamper with or make any adjustments or repairs to the door, control panel housing, safety interlock switches or any other part of the oven. Do not remove the outer panel from the oven which gives protection against exposure to microwave energy. Repairs should only be by a qualified service person.
- Warning! Do not place this oven near an electric or gas cooker range.

- Liquids and other foods must not be heated in sealed containers since they are liable to explode.
- Warning! Only allow children to use the oven without supervision when adequate instructions have been given so that the child is able to use the oven in a safe way and understands the hazards of improper use.
- This oven is intended for counter-top use only. It is not intended for built-in use or use inside a cupboard.

For countertop use:

- Place the oven on a flat and stable surface more than 85 cm above the floor.
- Allow 15 cm of space on the top of the oven, 10 cm at the back, 5 cm on one side, and the other side must be opened more than 40 cm.

- When heating food in plastic or paper containers, check the oven frequently as these types of containers ignite if overheated.
- If smoke is emitted or a fire occurs in the oven, press Stop/Cancel button and leave the door closed in order to stifle any flames. Disconnect the power cord, or shut off power at fuse or circuit breaker panel.
- When heating liquids, e.g. soup, sauces and beverages in your oven, overheating the liquid beyond boiling point can occur without evidence of bubbling. This could result in a sudden boil over of the hot liquid.
- The contents of feeding bottles and baby food jars are to be stirred or shaken. The temperature has to be checked before consumption to avoid burns.
- Do not cook eggs in their shells and whole

hard-boiled eggs by MICROWAVE. Pressure may build up and the eggs may explode, even after the microwave heating has ended.

- Clean the inside of the oven, door seals and door seal areas regularly. When food splatters or spilled liquids adhere to the oven walls, door seals and door seal areas wipe off with a damp cloth. Mild detergent may be used if they get very dirty.
- The use of harsh detergent or abrasive is not recommended. **DO NOT USE COMMERCIAL OVEN CLEANERS.**
- Failure to maintain the oven in a clean condition could lead to deterioration of surfaces that could affect the life of the appliance and possibly result in a hazardous situation.
- Only use utensils that are suitable for use in microwave ovens.

Contents

Installation and connection	7
Placement of your oven	7
Important safety instructions	8-11
Outline diagram	12
Control panel	13
Setting the clock	14
Child safety lock	14
Microwave cooking and defrosting	15
Defrosting guidelines	16
Defrosting charts	17
Using the timer	18
Multistage cooking	19
Using the memory function	20
Turbo defrost	21
Auto weight reheat / cook programs	22-23
Reheating & cooking charts	24-25
Recipes	26
Questions and answers	27
Care of your oven	28
Technical specifications	29

Thank you for purchasing a Panasonic Microwave Oven.

Installation and connection

Examine your microwave oven. Unpack the oven, remove all packing material, and examine the oven for any damage such as dents, broken door latches or cracks in the door. If you find any damage, notify your dealer immediately. Do not install a damaged microwave oven.

Earthing instructions

■ Important!

THIS UNIT HAS TO BE PROPERLY EARTHED FOR PERSONAL SAFETY.

If your AC outlet is not grounded, it is the personal responsibility of the customer to have it replaced with a properly grounded wall socket.

Operation voltage

The voltage has to be the same as specified on the label on the oven. If a higher voltage than specified is used, it may cause a fire or other damages.

Placement of your oven

This oven is intended for counter-top use only. It is not intended for built-in use or use inside a cupboard.

Counter-top use:

- Place the oven on a flat and stable surface more than 85 cm above the floor.
- When this oven is installed, it should be easy to isolate the appliance from the electricity supply by pulling out the plug or operating a circuit breaker.
- For proper operation, ensure a sufficient air circulation for the oven.
- Allow 15 cm of space on the top of the oven, 10 cm at the back, 5 cm on one side, and the other side must be opened more than 40 cm.
- Do not place this oven near an electric or gas cooker range.
- The feet should not be removed.
- This oven is only for household usage. Do not use outdoors.
- Avoid using the oven in high humidity.
- The power cord should not touch the outside of the oven. Keep the cord away from hot surfaces. Do not let the cord hang over the edge of a table or work top. Do not immerse the cord, plug or oven in water.
- Do not block the air vents on the sides and back of the oven. If these openings are blocked during operation the oven may overheat. In this case the oven is protected by a thermal safety device and resumes operation only after cooling down.
- This appliance is not intended to be operated by means of an external timer or separate remote-control system.

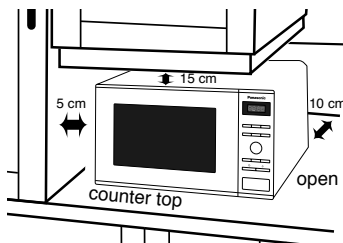

Important safety instructions

■ WARNING!

Important safety instructions

1. The door seals and seal areas should be cleaned with a damp cloth. The appliance should be inspected for damage to the door seals and door seal areas and if these areas are damaged the appliance should not be operated until it has been repaired by a service technician trained by the manufacturer.
2. Do not attempt to tamper with or make any adjustments or repairs to the door, control panel housing, safety interlock switches or any other part of the oven. Do not remove the outer panel from the oven which gives protection against exposure to microwave energy. Repairs should only be carried out by a qualified service person.
3. Do not operate this appliance if it has a damaged CORD OR PLUG, if it is not working properly, or if it has been damaged or dropped. It is dangerous for anyone other than a service technician trained by the manufacturer to perform repair service.
4. If the supply cord is damaged, it must be replaced by the manufacturer or its service agent or a similarly qualified person in order to avoid a hazard.
5. Only allow children to use the oven without supervision when adequate instructions have been given so that the child is able to use the oven in a safe way and understands the hazards of improper use.
6. Liquids and other foods must not be heated in sealed containers since they are liable to explode.
7. Users are advised to avoid a downward pressure on the microwave oven door when in the open position. There is a safety risk that the oven will tilt forward.
8. This appliance can be used by children aged from 8 years and above and persons with reduced physical, sensory and mental capabilities or lack of experience and knowledge if they have been given supervision or instruction by a person responsible for their safety concerning the use of the appliance in a safe way and understand the hazards involved. Children shall not play with the appliance. Cleaning and user maintenance shall not be made by children without supervision. Keep the appliance and its cord out of reach of children less than 8 years.

Important safety instructions

Use of your oven

1. Do not use the oven for any reason other than the preparation of food. This oven is specifically designed to heat or cook food. Do not use this oven to heat chemicals or other non-food products.
2. Before use, check that utensils containers are suitable for use in microwave ovens.
3. Do not attempt to use this microwave oven to dry newspaper, clothing or any other materials. They may catch on fire.
4. When the oven is not being used, do not store any objects inside the oven in case it is accidentally turned on.
5. The appliance must not be operated by MICROWAVE WITHOUT FOOD IN THE OVEN. Operation in this manner may damage the appliance.
6. If smoke is emitted or a fire occurs in the oven, press Stop/Cancel button and leave the door closed in order to stifle any flames. Disconnect the power cord, or shut off power at fuse or circuit breaker panel.

Oven light

When it becomes necessary to replace the oven light, please consult your dealer.

Accessories

The oven comes equipped with a variety of accessories. Always follow the directions given for use of the accessories.

Glass tray

1. Do not operate the oven without the roller ring and the glass tray in place.
2. Never use another type of glass tray than the one specially designed for this oven.
3. If the glass tray is hot, let it cool before cleaning or placing in water.
4. The glass tray can turn in either direction.
5. If the food or cooking vessel on the glass tray touches the oven walls and stops the tray rotating, the tray will automatically rotate in the opposite direction. This is normal.
6. Do not cook foods directly on the glass tray, except when using the Auto Weight Program for baked potatoes.

Important safety instructions

Roller ring

1. The roller ring and the oven floor should be cleaned frequently to prevent noise and build-up of remaining food.
2. The roller ring must always be used for cooking together with the glass tray.

Cooking times

- The cooking time depends on the condition, temperature, amount of food and on the type of cookware.
- Begin with the minimum cooking time to help prevent overcooking. If the food is not sufficiently cooked you can always cook it for a little longer.

■ Important!

If the recommended cooking times are exceeded the food will be spoiled and in extreme circumstances could catch fire and possibly damage the interior of the oven.

Small quantities of foods

- Small quantities of food or foods with low moisture content can burn, dry out or catch on fire if cooked too long. If materials inside the oven should ignite, keep the oven door closed, turn the oven off and remove the plug from the socket.

Eggs

- Do not cook eggs in their shells and whole hard-boiled eggs by MICROWAVE. Pressure may build up and the eggs may explode, even after the microwave heating has ended.

Piercing Skin

- Food with non porous skins, such as potatoes, egg yolks and sausages must be pierced before cooking by MICROWAVE to prevent bursting.

Meat thermometer

- Use a meat thermometer to check the degree of cooking of roasts and poultry only when the meat has been removed from the oven. Do not use a conventional meat thermometer in the microwave oven because it may cause sparking.

Important safety instructions

Liquids

- When heating liquids, e.g. soup, sauces and beverages in your microwave oven, overheating the liquid beyond boiling point can occur without evidence of bubbling. This could result in a sudden boil over of the hot liquid.

To prevent this possibility the following steps should be taken:

- a Avoid using straight-sided containers with narrow necks.
- b Do not overheat.
- c Stir the liquid before placing the container in the oven and again halfway through the cooking time.
- d After heating, allow it to stand in the oven for a short time, stir again before carefully removing the container.

Paper/plastic

- When heating food in plastic or paper containers, check the oven frequently as these types of containers ignite if overheated.
- Do not use recycled paper products (e.g. Kitchen Roll) unless the paper product is labelled as safe for microwave oven use. Recycled paper products may contain impurities which may cause sparks and/or fires during use.
- Remove wire twist-ties from roasting bags before placing the bags in the oven.

Utensils/foil

- Do not heat any closed cans or bottles because they might explode.
- Metal containers or dishes with metallic trim should not be used during microwave cooking. Sparking will occur.
- If you use any aluminium foil, meat spikes or metalware the distance between them and the oven walls and door should be at least 2 cm to prevent sparking.

Feeding bottles/baby food jars

- The top and teat or lid must be removed from feeding bottles or baby food jars before placing in the oven.
- The contents of feeding bottles and baby food jars are to be stirred or shaken.
- The temperature has to be checked before consumption to avoid burns.

Outline diagram

- 1. Door release**
Press to open the door. When you open the oven door during cooking, the cooking is stopped temporarily without clearing earlier made settings. The cooking is resumed as soon as the door is closed and Start button pressed.
- 2. Oven window**
- 3. Door safety lock system**
- 4. Oven air vent**
- 5. Microwave feed guide (do not remove)**
- 6. External oven air vents**
- 7. Control panel**
- 8. Power supply cord**
- 9. Plug**
- 10. Identification Label**
- 11. Glass tray**
- 12. Roller ring**
- 13. Position your supplied auto program menu label here**

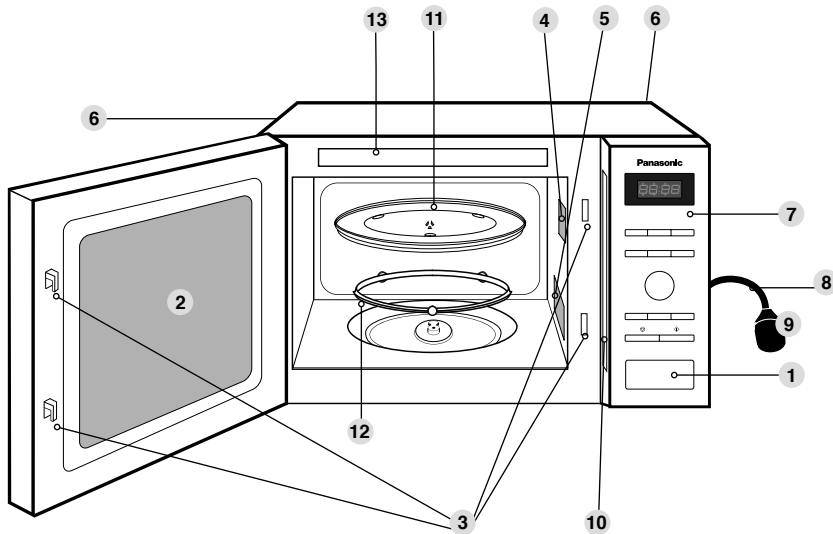

■ Note.
This illustration is for reference only.

Control panel NN-SD271S

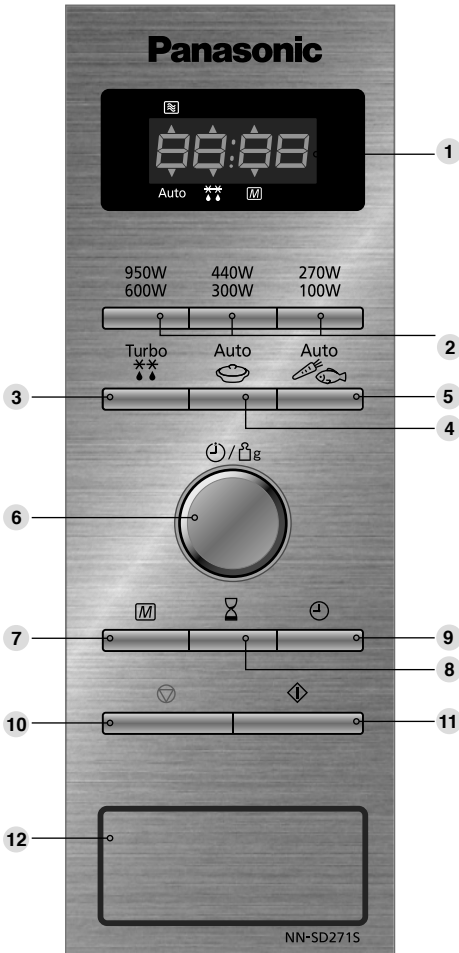

- 1 Display window
- 2 Microwave power levels button
- 3 Turbo defrost programs button
- 4 Auto reheat programs button
- 5 Auto cook programs button
- 6 Time / Weight selection dial
- 7 Memory button
- 8 Timer button
- 9 Clock button
- 10 Stop /Cancel button:
Before Cooking:
 One press clears your instructions
During Cooking:
 One press temporarily stops the cooking program. Another press cancels all your instructions and the time of day will appear in the display.
- 11 Start Button
- 12 Door Release

This oven is equipped with an energy saving function.

■ Please note

1. When in stand-by mode the brightness of the display will be reduced.
2. The oven will enter stand-by mode, when first plugged in and immediately after the last operation has completed.

■ Note

If an operation is set and start button is not pressed, after 6 minutes the oven will automatically cancel the operation. The display will revert back to clock mode.

■ Beep sound

When a button is pressed correctly a beep will be heard. If a button is pressed and no beep is heard, the unit has not or cannot accept the instruction. At the end of any complete program, the oven will beep 5 times.

Setting the clock

When the oven is first plugged in "88:88" appears in display window.

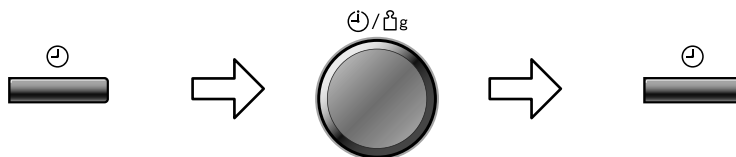

Press Clock once

A colon starts to blink.

Turn Time/Weight Dial.

Enter the time by turning the Time/Weight dial. The time appears in the display and the colon blinks.

Press Clock

The colon stops blinking. Time of day is now locked into the display.

■ **Notes**

1. To reset time of day, repeat step 1 through to step 3, as above.
2. The clock will keep the time of day as long as the oven is plugged in and electricity is supplied.
3. This is a 24 hour clock, ie 2pm = 14:00 not 2:00.

Child safety lock

Using this system will make the oven controls inoperable; however, the door can be opened. Child Lock can be set when the display shows a colon or the time.

To Set:



Press Start three times

The time of day will disappear. Actual time will not be lost. '----' is indicated in the display.

To Cancel:



Press Stop / Cancel three times

The time of day will reappear in the display.

■ **Note**

1. To activate child lock, Start must be pressed 3 times within a 10 second period.

Microwave cooking and defrosting

The glass tray must always be in position when using the oven.

950W 600W	1 Press	950 Watts	Max
	2 Presses	600 Watts	Medium
440W 300W	1 Press	440 Watts	Low
	2 Presses	300 Watts	Simmer
270W 100W	1 Press	270 Watts	Defrost
	2 Presses	100 Watts	Warm

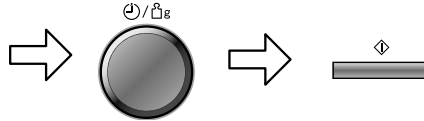

Select the desired Microwave power level.

Set the cooking time using the Time/Weight dial (HIGH power: up to 30 minutes other powers: up to 90 minutes)

Press Start Button. The cooking program will start and the time in the display will count down.

■ CAUTION!

The oven will automatically work on MAX microwave power if a cooking time is entered without the power level previously being selected.

■ Notes

1. For multi-stage cooking refer to page 19 EN.
2. Stand time can be programmed after microwave power and time setting. Refer to using the timer page 18 EN.
3. You can change the cooking time during cooking if required. Turn Time/Weight Dial to increase or decrease the cooking time. Time can be increased/decreased in 1 minute increments, up to 10 minutes. Turning the dial to zero will end cooking.

Defrosting guidelines

Tips for defrosting

Check the defrosting several times, even if you use the auto programs. Observe the standing times.

Standing times

Individual portions of food may be cooked almost immediately after defrosting. It is normal for large portions of food to be frozen in the centre. Before cooking, allow to stand for a **minimum of one hour**. During this standing time, the temperature becomes evenly distributed and the food is defrosted by conduction. N.B. If the food is not going to be cooked immediately, store it in the refrigerator. Never refreeze defrosted food without first cooking it.

Joints and poultry

It is preferable to place the joints on an upturned plate or plastic rack so that they are not resting in the juices. It is essential to protect delicate or projecting parts of this food with small pieces of foil to prevent these parts from cooking. **It is not dangerous to use small pieces of foil in your oven, provided they do not come into contact with the oven walls.**

Minced meat or cubes of meat and seafood

Since the outside of these foods quickly defrosts, it is necessary to separate them, break the blocks into pieces frequently while defrosting and remove them when they have defrosted.

Small portions of food

Chops and chicken pieces must be separated as soon as possible so that they defrost evenly throughout. Fatty parts and the ends defrost more quickly. Place them near the centre of the glass tray or protect them.

Bread

Loaves will require standing time to allow the centre to thaw. Standing time can be shortened if slices are separated and rolls and loaves cut in half.

Beep Sounds

Beeps will sound during the Turbo Defrost programs. The beeps are to remind you to check, stir, separate the pieces, or shield small parts. Failure to do this may result in uneven defrosting.



Defrosting charts

Food	Weight/Quantity	Defrosting time & mode	Standing Times (minimum)
Baguette (3)	150g	MAX 30 s	-
Bread rolls (3)	1 piece (85g)	MAX 30 to 40 s	-
	3 x 85g	MAX 40s to 1 min	-
Bread - slice (3)	60g	MAX 10 to 20 sec	-
breakfast pastries (3)	2 x 50g	MAX 30 to 40 s or 270W 3 mins	-
Brioche (1) (3)	300g	270W 5 to 6 min	5 mins
	500g	270W 6 to 8 mins	5 mins
butter (1)	250g	270W 2 to 3 min 30s	15 mins
Cheese - Quark	250g	270W 6 to 8 mins	10 mins
Cream	600ml	270W 6 to 8 mins	10 mins
Fish whole (2)	500g	270W 12-14 mins	15 mins
Fish fillets, thin (2)	500g (4 pce)	270W 10 to 12 mins	10 mins
Fish fillets, thick (2)	380g	270W 12 to 14 mins	10 mins
Fish steaks without bone (2)	260g	270W 9 to 10 mins	15 mins
hamburger (1)	200g	270W 6to 7 mins	10 mins
	400g	270W 10 to 12 mins	10 mins
pork sausages	300g	270W 4 to 5 mins	10 mins
Pastry - puff	375g	270W 4 to 5 mins	10 mins
Pastry - shortcrust	500g	270W 6 to 8 mins	5 mins
red fruit (2)	200g	270W 6 to 8 mins	15 mins
	300g	270W 10 to 12 mins	15 mins
	500g	270W 12 to 14 mins	15 mins
Salami (thin) (2)	250g (12 slices)	270W 5 to 6 min	5 mins
shrimps/prawns (2)	200g	270W 7 to 9 min	10 mins
Desserts			
Black Forest (3)	600g	270W 10 to 12 min	15 mins
Chocolate fondant (3)	1 pce 500g	440W 3 min	10 mins
Victoria sandwich cake (3)	400g	270W 7 to 8 mins	10 mins
Fruit Tart (3)	1 slice	270W 3 to 4 mins	10 mins
	470g	270W 8 to 10 mins	10 mins
Waffles (3)	1 pce	MAX 20 to 30 s	-
	2 pce	MAX 50s	-

(1) turn or stir at half time. (2) Separate and turn several times (3) remove packaging and place on a heat-resistant plate.

Using the timer

Delay Start Cooking

By using the Timer, you are able to program Delay Start cooking.

example

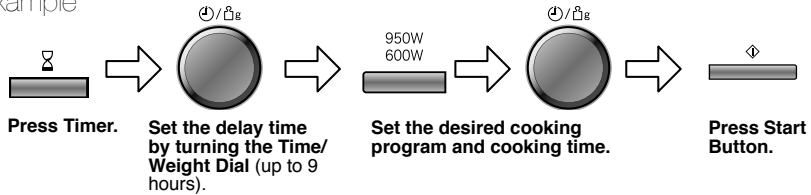

Notes

1. Three stage cooking can be programmed including Delay Start cooking.

example

Delay Start: 1 hour

MAX Power: 10 min.

Simmer Power 300W: 20 min

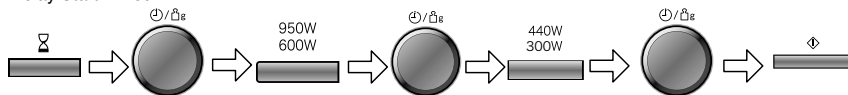

2. If the programmed delay time exceeds one hour, the time will count down in units of minutes. If less than one hour, the time will count down in units of seconds.
3. Delay Start cannot be programmed before an auto program.

Stand Time

By using the Timer, you can program Stand Time after cooking is completed or use to program the oven as a minute timer.

example

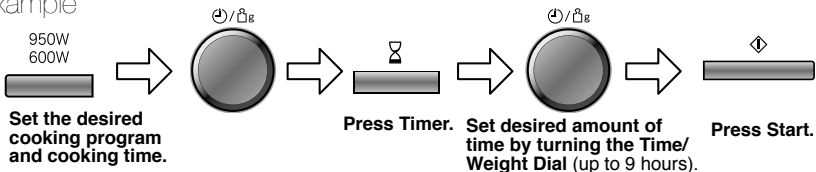

Notes

1. Three stage cooking can be programmed including stand time.

example

MAX Power: 4min

Stand Time: 5min

MAX Power: 2min

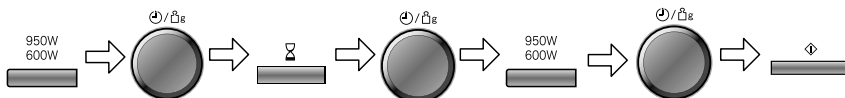

2. If the oven door is opened during the Stand Time or Minute Timer, the time in the display window will continue to count down.
3. This feature may also be used as a minute timer. In this case press the Timer, set time and press Start.
4. Stand time cannot be programmed after an auto program.

Multistage cooking

2 or 3 stage cooking

Example:

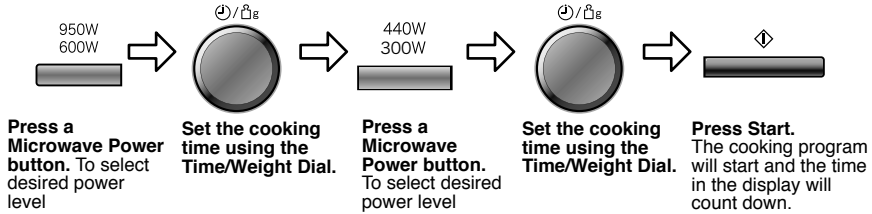

Example: To cook at 950W for 2 minutes and cook food at 300W for 3 minutes.

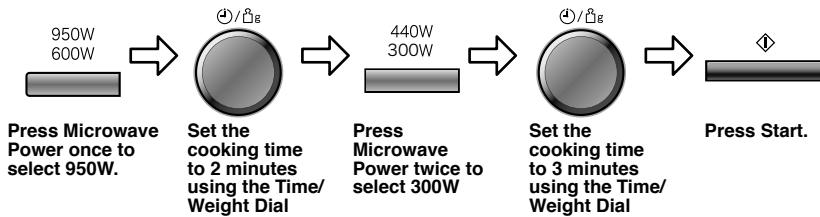

Example: To cook at 600W for 5 minutes and cook food at 100W for 4 minutes.

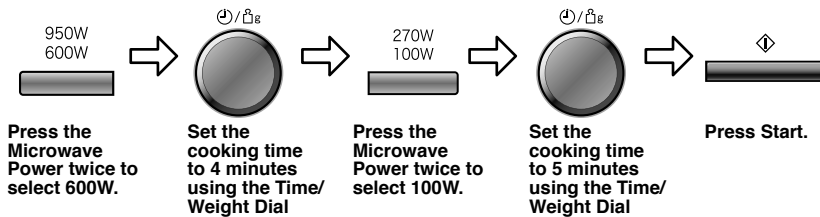

NOTE

1. For 3 stage cooking, enter another cooking program before pressing start.
2. During operation, pressing Stop/Cancel once will stop the operation. Pressing Start will re-start the programmed operation. Pressing Stop/Cancel twice will stop and clear the programmed operation.
3. Whilst not operating, pressing Stop/Cancel will clear the selected program.
4. Auto programs can not be used with multi-stage cooking.

Using the memory function

This feature allows you to pre-program your oven for a regular reheating or cooking task. You are able to pre-program your oven for a specific power level and time that is convenient for you. You can only pre-program one memory task with this oven.

To set a memory program

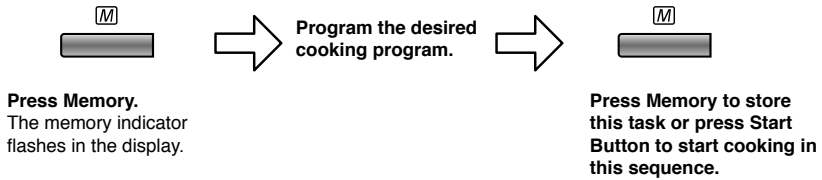

To use a memory program

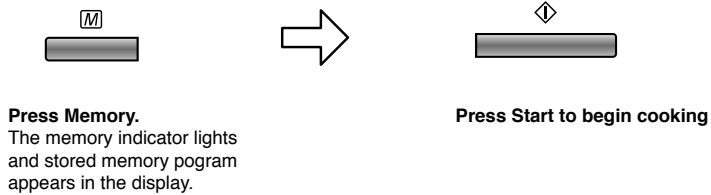

■ Notes

1. Auto programs cannot be programmed into memory.
2. Memory can only store 1 stage cooking. It is not possible to store 2 or 3 stage cooking.
3. Setting a new cooking program into memory will cancel the cooking program previously stored.
4. Memory program will be cancelled if the power supply is off or the plug is disconnected.

Turbo defrost

With this feature you can defrost frozen food according to the weight.

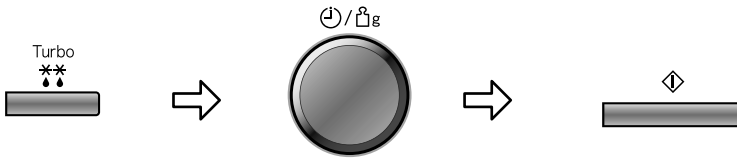

Select the desired Turbo Defrost program

- 1 Press Small Pieces
- 2 Presses Big Piece
- 3 Presses Bread

Auto program number appears in the display. The microwave, auto and defrost indicators light.

Set the weight of the frozen food by using the Time/Weight Dial.

Turning the dial slowly will count up in 10g steps. Turning the dial quickly will count up in 100g steps.

Press Start

Remember to stir or turn the food during defrosting.

Program	Weight Range	Suitable Food
1. SMALL PIECES 1 press	150 - 1000g	Small pieces of meat, escallop, sausages, minced meat, steak, chops, fish fillets (each 100g to 400g). Press turbo defrost once. Turn/stir at beeps.
2. BIG PIECE 2 presses	400 - 2000g	Big pieces of meat, whole chickens, meat joints. Press turbo defrost twice. Whole chickens and meat joints will require shielding during defrosting. Protect wings, breast and fat with smooth pieces of aluminum foil secured with cocktail sticks. Do not allow the foil to touch the walls of the oven. Standing time of 1 to 2 hours should be allowed before cooking. Turn and shield at beeps.
3. BREAD 3 presses	100 - 800g	Small or large loaves of bread, white or wholewheat. Place the loaf on a piece of kitchen roll. Press turbo defrost three times and turn at beep. Allow bread to stand for 5 min (white light bread) to 30 min (dense rye bread). Cut large loaves in half during standing time.

■ Important!

See page 16 EN for defrosting guidelines.

Auto weight reheat / cook programs

With this feature food can be cooked or reheated according to the weight. The weight has to be entered in grams.

example

Select desired category
The microwave and auto indicator lights, frozen indicator also lights for frozen food auto programs. The program number appears in the display.





Set Weight.
Set the weight of the food by using the Time/Weight Dial. Turning the dial slowly will count up in 10g steps. Turning the dial quickly will count up in 100g steps.

Press Start

Auto weight reheat programs

Program	Weight	Instructions
4. CHILLED SOUP Auto 1 press	150 - 1000g	For reheating chilled soup. Place soup into a suitable sized container. Foods should be at refrigerator temperature approx +5°C. Cover, press auto cook once and stir at beeps. Stir again at end of program and allow a few minutes standing time.
5. CHILLED MEAL Auto 2 presses	200 - 1000g	To reheat a fresh plated meal or casserole. All foods must be pre-cooked. Foods should be at refrigerator temperature approx. + 5°C. Cover, press auto cook twice and stir at beeps. Stir again at end of program and allow a few minutes standing time. Large pieces of meat/fish in a thin sauce may require longer cooking. This program is not suitable for starchy food such as rice, noodles or potatoes.
6. FROZEN MEAL Auto 3 presses	200 - 1000g	To reheat a frozen precooked meal or casserole; All foods must be pre-cooked and frozen (-18°C); Cover. Press auto cook three times. Stir at beeps and cut the blocks into pieces. Stir again at end of program and allow a few minutes standing time. Check temperature and cook further minutes if necessary before eating. This program is not suitable for portionable frozen foods.

Auto weight cook programs

Program	Weight	Instructions
7. FRESH VEGETABLES Auto  1 press	200-800g	To cook fresh vegetables. Place prepared vegetables into a suitable sized container. Sprinkle with 1 tbsp water per 100g vegetables. Cover with pierced cling film or a lid. Press auto cook once. Stir at beeps. Drain after cooking and season to taste.
8. FRESH FISH Auto  2 presses	200 - 800g	To cook fresh fillets or steaks of fish. Place in a suitable sized container, add 2 tbsp (30ml) water. Cover with pierced cling film or a lid. Press auto cook twice.
9. BAKED POTATOES Auto  3 presses	200 - 1400g	For cooking baked potatoes. Choose medium sized potatoes 200-250g for best results. Wash and dry potatoes and prick with a fork several times. Place directly on glass tray around outer edge. Press auto cook three times. After cooking wrap in aluminium foil and stand for 5 minutes.
10. RICE Auto  4 presses	100 - 300g	For cooking rice for savoury dishes not rice puddings. (Thai, Basmati, Jasmine, Suriname, Arborio or Mediterranean rice). Rinse the rice thoroughly before cooking. Use a large bowl. Add ½ tsp salt and 2 times boiling water to rice. Cover with a lid or pierced cling film. Press auto cook four times. Stir at the beep. Allow to stand for 5 minutes after cooking.

■ Notes

1. The Auto Weight Programs must ONLY be used for foods described.
2. Only cook foods within the weight ranges described.
3. Always weigh the food rather than relying on the package information.
4. Most foods benefit from a **STANDING** time, after cooking with an Auto Program, to allow heat to continue conducting to the centre.
5. To allow for some variations that occur in food, check that food is thoroughly cooked and piping hot before serving.

Reheating & cooking charts

Food	Weight/Quantity	Fresh	Frozen
Drinks - Coffee - Milk			
1 mug	240ml	Max 1 min 30s	-
2 mugs	470ml	Max 2 min 30s	-
1 jug	600ml	Max 4 min 30s to 5 min	-
Soup (chilled) (1,2)	300ml	Max 3 to 3 min 30s	-
	1000ml	Max 10 min	-
Soup (ambient) (1,2)	300ml	Max 2 min 30s to 3 min	-
	1000ml	Max 7 to 7 min 30s	-
Convenience Foods			
Croque monsieur	1 piece (170g)	Max 30s to 50 s	Max 2 min to 2min 30s
	2 pieces (320g)	Max 1 min 30s to 2 min	Max 4 min 30s to 5 min
unfilled pancake (2)	1 piece	Max 30 s	
stuffed pancake (1,2)	1 piece (150g)	Max 1 min 30s	Max 3 min to 3 min 30s
	2 pieces (300g)	Max 2 min 30s to 3 min	Max 5 min to 5 min 30s
small pizza (3)	1 piece (160g)	Max 1 min	Max 2 min 30s to 3 min
american pizza	1 piece (400g)	Max 4 to 5 mins	max 6 to 7 mins
small quiche (3)	1 piece (175g)	600W 1 min 40 s to 2 min	Max 2 min 30s to 3 min
large quiche	1 piece (400g)	600W 3 to 4 mins	600W 7 to 8 mins
samosa (1)	2 pieces (150g)	Max 1 to 1 min 30s	Max 2 to 2 min 30s
Meat balls - frikadellen (1,2)	1 piece 100g	600W 1 min to 1 min 30 s	-
	2 pcs 200g	600W 2 to 3 mins	600W 5 mins
Plated Meals			
Chilli con carne (1,2)	355g	MAX 3 min 30 s	MAX 7 to 8 min
Chicken korma with rice (1,2)	350g	MAX 7 min	MAX 6 to 7 min
Lasagne (meat gratin) (4)	300 - 400g	MAX 3 min	MAX 10 to 12 mins
	600g	MAX 7 to 8 min	MAX 14 to 15 mins
	1 kg	MAX 11 min	MAX 20 to 22 mins
Vegetable gratin (4)	300 - 400g	MAX 6 mins	MAX 10 to 12 mins
	1 kg	MAX 12 mins	-
fish gratin (4)	400g	MAX 4 min 30s to 5 mins	600W 13 to 15 mins
	700 g	MAX 8 mins	MAX 15 to 16 mins + 300W 4 mins

(1) turn or stir at half time. (2) cover. (3) remove packaging and place on a heat-resistant plate. (4) Remove aluminium tray and put the gratin in a heat-resistant microwavable dish.

■ Points for checking

Always check that food is piping hot after reheating in the microwave. If unsure return to oven. Foods will still require a **STAND TIME**, especially if they cannot be stirred. The denser the food the longer the stand time.

Reheating & cooking charts

Food	Weight/Quantity	Fresh	Frozen
Fish in sauce (1,2)	225g	-	MAX 5 to 8 mins
Puree (1,2) of potato of vegetables	200g	MAX 2 min	MAX 4 min 30s
	200g	MAX 2 min to 2 min 30 s	Max 5 min to 5 min 30s
	400g	MAX 4 min	MAX 8 min
Spaghetti in sauce (1,2)	450g	MAX 3 min 30s to 4 mins	MAX 8 min
Rice (2)	150g	MAX 1 to 1 min 30s	MAX 2 min 30 s
	300g	Max 2 min 30s to 3 min	MAX 4 min 30 s
Baby food (small pot at room temp)	120g	600W 30s TEST	-
	200g	600W 40 to 50s TEST	-
Meat			
Hamburger (raw) (2)	1 piece (150g)	-	MAX 2 min to 2 min 30s
Cocktail sausages (1,2)	120g	300W 2 to 2 min 30s	-
Pieces of cooked meat			
Pork 2 pieces (2)	130g	600W 1 min 30 s	-
Lamb 2 pieces (2)	160g	600W 1 min	-
Beef 2 pieces (2)	120g	600W 1 to 1 min 30s	-
Chicken leg (2)	205g	MAX 2 to 3 mins	-
Chicken nuggets	10 pieces (200g)	-	MAX 2min 30 s
Cordon bleu	1 piece (100g)	-	MAX 2min to 2 min 30 s

(1) turn or stir at half time. (2) cover. (3) remove packaging and place on a heat-resistant plate. (4) Remove aluminium tray and put the gratin in a heat-resistant microwavable dish.

■ Points for checking

Always check that food is piping hot after reheating in the microwave. If unsure return to oven. Foods will still require a **STAND TIME**, especially if they cannot be stirred. The denser the food the longer the stand time.

ingredients

SERVES 4

- 4 bread rolls, day old (approx 220g)
- 150 ml milk
- 40 g of butter
- 3 eggs
- 3 tbsp. chopped parsley
- salt

Containers: 1 large bowl and 1 Pyrex plate

Bread dumplings

Cut or tear the rolls into very small pieces and salt them lightly. Heat milk with butter on MAX for 1 min and pour over bread. Cover and stand for 15 mins. Beat the eggs, add to the bread mixture with the parsley and mix well. With wet hands form 4 balls of the same size. Dip quickly into cold water, take out and place onto the plate. Cover and cook on 600W for 5 to 6 mins. Serve immediately with a meat stew.

Note: for variation add 50g of finely cut cooked smoked bacon to the mixture. Or, after cooking, fry the Meatballs in a skillet in hot butter for a more colorful result.

ingredients

SERVES 4

- 150g large lentils
- 1 onion, diced
- 25g of butter
- 500 g turkey fillet, cubed
- 1 tbsp flour
- 1 tbsp curry powder
- 130 ml vegetable stock
- juice of ½ lemon
- 1 tbsp sugar
- 130 ml cream.

Dish: 2 large bowls

Turkey and lentil curry

Cover the lentils in cold water. Cover and cook on MAX for 8-10 mins. to bring to the boil. Continue cooking on 300W for 15 to 18 mins (check the lentils are always covered in water). Drain and leave to stand.

In a separate bowl place the onion and butter and cook on MAX for 3 mins. Add the turkey, mix and cook on MAX for a further 4 to 5 mins. Add the curry powder mixed with the flour, vegetable stock, lemon juice, sugar, lentils and cream. Mix well, cover, and cook on MAX for 5-6 mins. Check the seasoning before serving.

ingredients

SERVES 4

- 125 g short grain rice
- 500 ml milk
- 1 tsp butter
- 2 tbsp sugar
- cinnamon sugar to taste.

Dish: Large bowl

Rice pudding

Place rice, milk, butter and sugar into the bowl. Bring to the boil by cooking on MAX for 6 to 7 mins. Cover and cook on 300W for 20 to 25 mins, stirring several times. Leave to stand for 5 mins before stirring again and adding cinnamon sugar to taste.

Tip: you can add fruit compote instead of cinnamon sugar.

Questions and answers

Q: Why won't my oven turn on?

- A: When the oven does not turn on, check the following:
1. Is the oven plugged in securely?
Remove the plug from the outlet, wait 10 seconds and reinsert.
 2. Check the circuit breaker and the fuse.
Reset the circuit breaker or replace the fuse if it is tripped or blown.
 3. If the circuit breaker or fuse is all right, plug another appliance into the outlet.
If the other appliance works, there probably is a problem with the oven.
If the other appliance does not work, there probably is a problem with the outlet.

If it seems that there is a problem with the oven, contact an authorized Service Centre.

Q: My microwave oven causes interference with my TV. Is this normal?

- A: Some radio and TV interference might occur when you cook with the microwave oven. This interference is similar to the interference caused by small appliances such as mixers, vacuums, blow dryers, etc. It does not indicate a problem with your oven.

Q: The oven won't accept my program. Why?

- A: The oven is designed not to accept an incorrect program. For example, the oven will not accept a fourth stage, and will not accept an Auto Weight Program after Delay Start.

Q: Sometimes warm air comes from the oven vents. Why?

- A: The heat given off from the cooking food warms the air in the oven cavity. This warmed air is carried out of the oven by the air flow pattern in the oven. There are no microwaves in the air. The oven vents should never be blocked during cooking.

Q: The oven stops cooking by microwave and 'H97' or 'H98' appears in the display. Why?

- A: This display indicates a problem with the microwave generation system. Please contact an authorised Service Centre.

Care of your oven

1. Turn the oven off before cleaning.
2. Clean the inside of the oven, door seals and door seal areas regularly. When food splatters or spilled liquids adhere to the oven walls, door seals and door seal areas wipe off with a damp cloth. Mild detergent may be used if they get very dirty. The use of harsh detergent or abrasive is not recommended.
DO NOT USE COMMERCIAL OVEN CLEANERS.
3. The outside oven surface should be cleaned with a damp cloth. To prevent damage to the operating parts inside the oven, water should not be allowed to seep into the ventilation openings.
4. If the Control Panel becomes dirty, clean it with a soft, dry cloth. Do not use harsh detergents or abrasives on the Control Panel. When cleaning the Control Panel leave the oven door open to prevent the oven from accidentally turning on. After cleaning touch STOP/CANCEL button to clear display window.
5. If steam accumulates inside or around the outside of the oven door, wipe with a soft cloth. This may occur when the microwave oven is operated under high humidity conditions and in no way indicates a malfunction of the unit.
6. It is occasionally necessary to remove the glass tray for cleaning. Wash the tray in warm soapy water or in a dishwasher.
7. The roller ring and oven cavity floor should be cleaned regularly to avoid excessive noise. Simply wipe the bottom surface of the oven with mild detergent and hot water then dry with a clean cloth. The roller ring may be washed in mild soapy water. Cooking vapours collect during repeated use but in no way affects the bottom surface or roller ring wheels. After removing the roller ring from the cavity floor for cleaning, be sure to replace it in the proper position.
8. A steam cleaner is not to be used for cleaning.
9. This oven should only be serviced by qualified personnel. For maintenance and repair of the oven contact the nearest authorized dealer.
10. Failure to maintain the oven in a clean condition could lead to deterioration of surfaces that could affect the life of the appliance and possibly result in a hazardous situation.
11. Keep air vents clean at all times. Check that no dust or other material is blocking any of the air vents on the top, bottom or rear of the oven. If air vents become blocked this could cause overheating which would affect the operation of the oven and possibly result in a hazardous situation.

Technical specifications

Power Source:	230 V, 50 Hz
Power Consumption:	Microwave; 1150 W
Output:	Microwave; 950W (IEC-60705)
Outside Dimensions:	488 (W) x 395 (D) x 279 (H) mm
Oven Cavity Dimensions:	315 (W) x 353 (D) x 206 (H) mm
Uncrated Weight:	9.5 kg
Noise:	57dB

Specifications subject to change without notice.

This product is an equipment that fulfills the European standard for EMC disturbances (EMC = Electromagnetic Compatibility) EN 55011. According to this standard this product is an equipment of group 2, class B and is within required limits. Group 2 means that radio-frequency energy is intentionally generated in the form of electromagnetic radiation for purpose of warming or cooking food. Class B means that this product may be used in normal household areas.



Information on Disposal for Users of Waste Electrical & Electronic Equipment (private households)

This symbol on the products and/or accompanying documents means that used electrical and electronic products should not be mixed with general household waste.

For proper treatment, recovery and recycling, please take these products to designated collection points, where they will be accepted on a free of charge basis.

Alternatively, in some countries you may be able to return your products to your local retailer upon the purchase of an equivalent new product.

Disposing of this product correctly will help to save valuable resources and prevent any potential negative effects on human health and the environment which could otherwise arise from inappropriate waste handling. Please contact your local authority for further details of your nearest designated collection point.

Penalties may be applicable for incorrect disposal of this waste, in accordance with national legislation.

For business users in the European Union

If you wish to discard electrical and electronic equipment, please contact your dealer or supplier for further information.

Information on Disposal in other Countries outside the European Union

This symbol is only valid in the European Union.

If you wish to discard this product, please contact your local authorities or dealer and ask for the correct method of disposal.

Manufactured by: Panasonic Appliances Microwave Oven (Shanghai) Co., Ltd, 888, 898 Longdong Road, Pudong, Shanghai, 201203, China.
Imported by: Panasonic Marketing Europe GmbH
Contact: Panasonic Testing Centre Winsbergring 15, 22525 Hamburg, Germany.

Panasonic Corporation
<http://panasonic.net>

© Panasonic Corporation 2013

F0003BA02EP