HOOVER®

Washing machine

Instructions for use

VT D2



Introduction

Please read these instructions for use carefully and all other information enclosed with the washing machine.

Keep all documentation in a safe place for future reference or for any future owners.

This appliances is intended to be used in household and similar applications such as:

- staff kitchen areas in shops, offices and other working environments;
- farm houses;
- by clients in hotels, motels and other residential type environments;
- bed and breakfast type environments.

A different use of this appliance from household environment or from typical housekeeping functions, as commercial use by expert or trained users, is excluded even in the above applications.

If the appliance is used in a manner inconsistent with this it may reduce the life of the appliance and may void the manufacturer's warranty.

Any damage to the appliance or other damage or loss arising through use that is not consistent with domestic or household use (even if located in a domestic or household environment) shall not be accepted by the manufacturer to the fullest extent permitted by law.

Notes on disposal

All packaging material used is environmentally-friendly and recyclable. Please help dispose of the packaging via environmentally-friendly means.

Your supplier or local council will be able to give you details of current means of disposal.

Valuable materials can be salvaged from an old appliance via scrap reprocessing.

Note: pull out the mains plug from any old appliance. Cut the power cable and dispose of it, together with the plug.

When disposing of an old washing machine, please ensure that the door lock is rendered inoperable to prevent children shutting themselves in the appliance.

Contents

Page

Introduction	2
General delivery notes	4
Safety notes	4
Quick start	5
Description of controls	6
Programme Table	12
Programme selector	14
Detergent drawer	17
Detergents, washing aids and amounts to use	18
Useful advice for the user	20
The main wash	21
Cleaning and routine maintenance	23
Investigating malfunctions	25
Technical data	27
Setting up + installation	28

BEFORE SWITCHING ON THE APPLIANCE MAKE SURE IT IS CORRECTLY INSTALLED AND THAT THE FIXING SCREWS ARE REMOVED AS SHOWN IN PAGE 28.

General delivery notes

Please check that the following items are delivered with the appliance:

- Instruction manual
- Certificate of guarantee
- Inlet hose

Check that no damage has occurred during transit, and if so, call your nearest Authorised Technical Support Service agent.

Safety notes.

Note:

for cleaning or maintenance of the washing machine.

- A) Pull out the plug
- B) Turn off the tap
- C) **Hoover** equips all its appliances with earthing. Ensure that the mains supply is earthed, and if it is not, seek assistance from a qualified person.
- D) Do not touch the appliance when hands or feet are wet or damp. Do not use the appliance with bare feet.
- E) The use of adapters, multiple connectors and/or extensions is not recommended.

Note:

water temperature can reach 90°C during the wash cycle.

- F) Check there is no water left in the drum before opening the door.
- G) This appliance is not intended for use by persons (including children) with reduced physical, sensory or mental capabilities, or lack of experience and knowledge, unless they have been given supervision or instruction concerning use of the appliance by a person responsible for their safety.
Children should be supervised to ensure that they do not play with the appliance.
- H) Do not pull the power cable or the appliance itself to remove the plug from the socket.
- I) The appliance must not be exposed to weather conditions (rain, direct sun, etc...)
- L) When moving the appliance never lift it by the controls or by the detergent drawer.
When in transit never rest the door against the trolley or transport the appliance without the polystyrene base.

M) N.B!

If the appliance is installed on a carpeted floor ensure that the ventilation holes on the base of the appliance are not obstructed.

N) If the appliance is not running properly or breaks down, switch it off, turn off the tap and do not tamper with the appliance.

Consult only the Authorised Technical Support Service for possible repair and ask them to use original spare parts.

Failure to comply with the above can compromise the safety of the appliance.

O) If the appliance's power cable should ever need replacing, consult the Authorised Technical Support Service

Quick start

Washing

- Open the door by using the handle "A" (Fig. 1, page 6)
- Select laundry and put it in the machine
- Close the door
- Put detergent in the compartments as indicated in the programme guide in this instruction manual
- Select programme
- The display will show the settings for the programme selected.

Press additional function buttons (if required)

- Press the "Start/Pause" button (page 7)
- The programme starts.

After washing

- **The word "End" will appear on the display.**
- **Wait for the door lock to be released (about 2 minutes after the programme has finished). The "Door Security" indicator light will go out.**
- **Switch off the washing machine by turning the selector to "OFF" position.**
- **Open the door and remove the laundry.**

Ensure that the machine is correctly installed in line with the instructions found on page 28.

Description of controls

Fig. 1

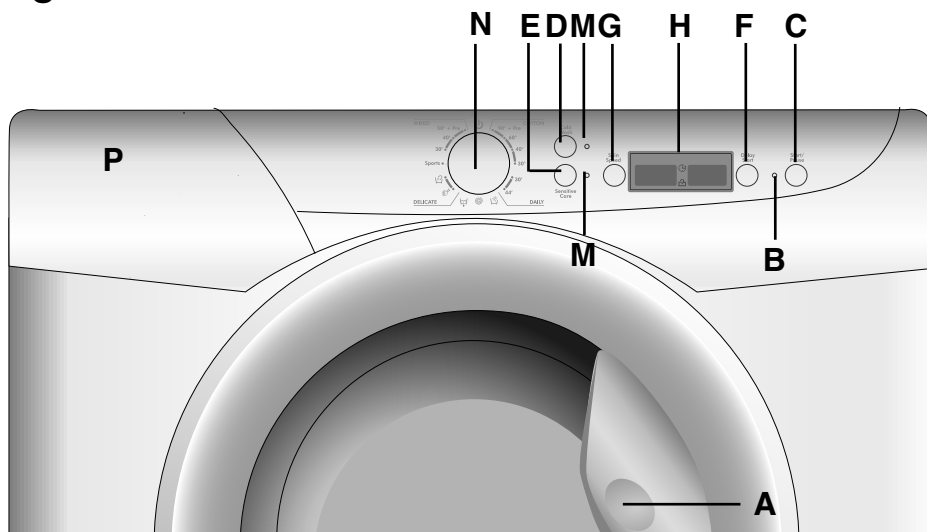

Door handle	A
Programme Start light	B
"Start/Pause" button	C
"Cold Wash" button	D
"Sensitive Care" button	E
"Delay Start" button	F
"Spin Speed" button	G
Digital display	H
Buttons indicator light	M
Programme selector with "OFF" position	N
Detergent drawer	P

Door handle

A

Press the finger-bar inside the door handle to open the door.

Programme Start light

B

This lights up when the START button has been pressed.

“START/PAUSE” button

C

Press to start the selected cycle .

NOTE: When the "Start/Pause" button has been pressed, the appliance can take few seconds before it starts working.

Changing the settings after the programmes has started (PAUSE)

Press and hold the “START/PAUSE” button for about 2 seconds, the flashing lights on the options buttons and time remaining indicator will show that the machine has been paused, adjust as required and press the “START/PAUSE” button again to cancel the flashing lights. If you wish to add or remove items during washing, wait 2 minutes until the safety device unlocks the door.

When you have carried out the manoeuvre, close the door, press **"Start/Pause"** button and the appliance will continue working where it left off.

CANCELLING THE PROGRAMME

To cancel the programme, set the selector to the OFF position.

Select a different programme.

Re-set the programme selector to the OFF position.

The option buttons should be selected before pressing the "Start/Pause" button.

“COLD WASH” button

D

By pressing this button it is possible to transform every programme into a cold washing one, without modifying other characteristics (water level, times, rythmes, etc...).

Curtains, small carpets, man made delicate fabrics, non color fast garments can be safely washed thanks to this new device.

“SENSITIVE CARE” button

E

By pressing this button you can activate a special new wash cycle in the **Cotton** and **Mixed Fabrics** programs, thanks to the new Sensor System. This option treats with care the fibres of garments and the delicate skin of those who wear them.

The load is washed in a much larger quantity of water and this, together with the new combined action of the drum rotation cycles, where water is filled and emptied, will give you garments which have been cleaned and rinsed to perfection. The amount of water in the wash is increased so that the detergent dissolves perfectly, ensuring an efficient cleaning action. The amount of water is also increased during the rinse procedure so as to remove all traces of detergent from the fibres. This function has been specifically designed for people with delicate and sensitive skin, for whom even a very small amount of detergent can cause irritation or allergy.

You are advised to also use this function for children's clothing and for delicate fabrics in general, or when washing garments made of towelling, where the fibres tend to absorb a greater quantity of detergent. To ensure the best performance for your wash, this function is always activated on the Delicates and Woollens/Handwash programs.

“DELAY START” button

F

This button allows you to pre-programme the wash cycle to delay the start of the cycle for up to 24 hours.

To delay the start use the following procedure:

Set the required programme.

Press the button once to activate it (h00 appears on the display) and then press it again to set a 1 hour delay (h01 appears on the display); the pre-set delay increases by 1 hour each time the button is pressed, until h24 appears on the display, at which point pressing the button again will reset the delay start to zero.

Confirm by pressing the “START/PAUSE” button (the light on the display starts to flash). The countdown will begin and when it has finished the programme will start automatically.

It is possible to cancel the delay start by taking the following action:

Press and hold the button for 5 seconds until the display will show the settings for the programme selected.

At this stage it is possible to start the programme previously selected by pressing the “START/PAUSE” button or to cancel the process by setting the selector to the OFF position and then selecting another programme.

Warning: If there is any break in the power supply while the machine is operating, a special memory stores the selected programme and, when the power is restored, it continues where it left off.

“SPIN SPEED” button

G

The spin cycle is very important to remove as much water as possible from the laundry without damaging the fabrics. You can adjust the spin speed of the machine to suit your needs.

By pressing this button, it is possible to reduce the maximum speed, and if you wish, the spin cycle can be cancelled.

To reactivate the spin cycle press the button until you reach the spin speed you would like to set.

To prevent damage to the fabrics, it is not possible to increase the speed over that which is automatically suitable during the selection of the program.

It is possible to modify the spin speed without to pausing the machine.

Note:

The machine is fitted with a special electronic device, which prevents the spin cycle should the load be unbalanced.

This reduces the noise and vibration in the machine and so prolongs the life of your machine.

“DIGITAL” Display

H

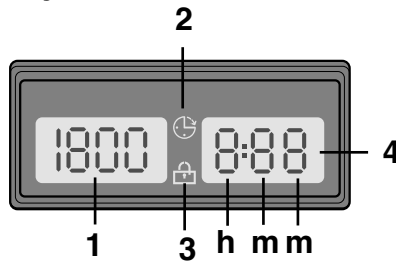

The display's indicator system allows you to be constantly informed about the status of the machine:

1) SPIN SPEED

Once the programme has been selected, the maximum spin speed allowed for that programme appears on the display. Pressing the spin button will reduce the speed by 100 rpm each time the button is pressed. The minimum speed allowed is 400 rpm, or it is possible to omit the spin by pressing the spin button repeatedly.

2) DELAY START LIGHT

This flashes when delay start has been set.

3) “DOOR SECURITY” indicator light

The “**Door Security**” indicator light is illuminated when the door is fully closed and the machine is ON. When “**Start/Pause**” is pressed on the machine with the door closed the indicator will flash momentarily and then illuminate.

If the door is not closed the indicator will continue to flash.

A special safety device prevents the door from being opened immediately after the end of the cycle. Wait for 2 minutes after the wash cycle has finished and the “**Door Security**” light has gone out before opening the door. At the end of the cycle turn the programme selector to “**OFF**”.

4) CYCLE DURATION

When a programme is selected the display automatically shows the cycle duration, which can vary, depending on the options selected.

Once the programme has started you will be kept informed constantly of the time remaining to the end of the wash.

The appliance calculates the time to the end of the selected programme based upon a standard loading, during the cycle, the appliance corrects the time to that applicable to the size and composition of the load.

Buttons indicator light

M

These light up when the relevant buttons are pressed.

If an option is selected that is not compatible with the selected programme then the light on the button first flashes and then goes off.

PROGRAMME selector with "OFF" position

N

WHEN THE PROGRAMME SELECTOR IS TURNED THE DISPLAY LIGHTS UP TO SHOW THE SETTINGS FOR THE PROGRAMME SELECTED.

FOR ENERGY SAVING, AT THE END OF THE CYCLE OR WITH AN INACTIVITY PERIOD, THE DISPLAY LEVEL CONTRAST WILL DECREASE.

N.B. TO SWITCH THE MACHINE OFF, TURN THE PROGRAMME SELECTOR TO THE "OFF" POSITION.

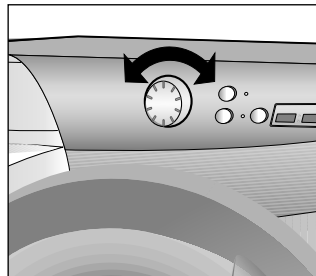

Press the "**Start/Pause**" button to start the selected cycle.







Once a programme is selected the programme selector remains stationary on the selected programme till cycle ends.

Switch off the washing machine by turning the selector to "**OFF**".

Note:

The programme selector must be returned to the "OFF" position at the end of each cycle or when starting a subsequent wash cycle prior to the next programme being selected and started.

TABLE OF PROGRAMMES

PROGRAM FOR:		PROGRAMME SELECTOR ON:	WEIGHT MAX kg*		TEMP. °C	CHARGE DETERGENT		
						2		1
Resistant fabrics Cotton, linen	Whites with Prewash	90° + Pre	7	8	90°	●	●	●
Cotton, mixed	Fast coloureds	60° **	7	8	60°	●	●	
	Fast coloureds	40° **	7	8	40°	●	●	
	Non fast coloureds	30°	7	8	30°	●	●	
Daily	Resistant or Mixed fabrics	30'	2	2,5	30°	●	●	
	Resistant or Mixed fabrics	44'	3	3,5	40°	●	●	
Specials	Rinse		-	-	-		●	
	Fast spin		-	-	-			
	Drain only		-	-	-			
Very delicate fabrics	"MACHINE WASHABLE" woollens		1,5	2	40°	●	●	
	Hand wash		1	1,5	30°	●	●	
	Mixed fabrics	Sports	2,5	2,5	30°	●	●	
Mixed fabrics and synthetics Synthetics (nylon, perlon), mixed cotton	Shirts 	30°	3,5	4	30°	●	●	
	Non fast coloureds	40°	3,5	4	40°	●	●	
	Fast coloureds with Prewash	50° + Pre	3,5	4	50°	●	●	●

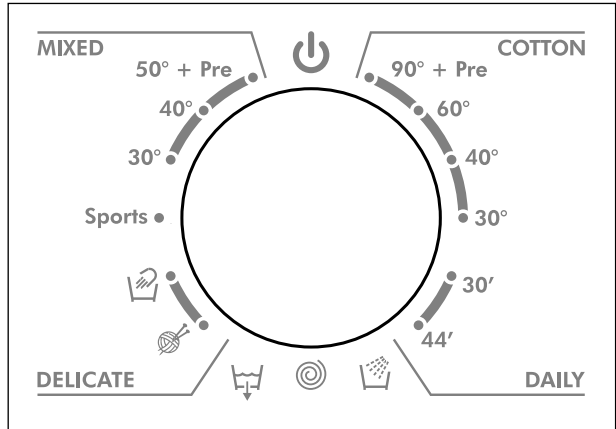
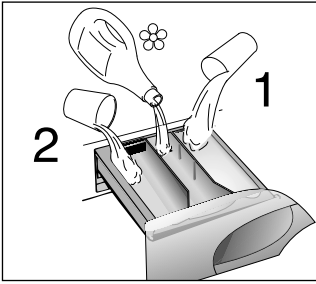

Please read these notes

* Maximum load capacity of dry clothes, according to the model used (see rating plate).

When washing heavily soiled laundry it is recommended the load is reduced to 3/4 kg maximum.

**** STANDARD COTTON PROGRAMMES ACCORDING TO (EU) No 1015/2010 and No 1061/2010**

COTTON PROGRAMME with a temperature of 60°C
 COTTON PROGRAMME with a temperature of 40°C

These programmes are suitable to clean normally soiled cotton laundry and they are the most efficient programmes in terms of combined energy and water consumptions for washing cotton laundry.

These programmes have been developed to be compliant with the temperature on the wash label on the garments and the actual water temperature may slightly differ from the declared temperature of the cycle.

The spin speed may also be reduced, to match any guidelines suggested on the fabric label, or for very delicate fabrics cancel the spin completely this option is available with a spin speed button.

Programme selector

For the various types of fabrics and various degrees of dirt the washing machine has different programme bands according to: wash cycle, temperature and length of cycle (see table of washing cycle programmes).

RESISTANTS FABRICS

The Cotton programmes are designed for maximum washing and rinsing efficiency. With spin cycles in between, the programme guarantees the laundry is rinsed perfectly. The final spin cycle ensures laundry is spun dry as much as possible up to the maximum speed.

The Cotton programme includes a Prewash cycle. This option is particularly useful for really dirty loads and can be used independently of the main wash programme. Additional detergent for the Prewash part of the programme should be added to the first compartment of the soap drawer labelled "I" (please refer to the section of this manual entitled "Detergent"). We recommend you use only 20% of the quantity used for the main wash programme.

COTTON

DAILY WASH 30°C – FAST 30'

A complete washing cycle (wash, rinse and spin), able to wash in approximately 30 minutes:

- a maximum load of 2/2,5 kg;
- lightly soiled fabrics (cotton and mixed fabrics)

We recommend, with this programme, a 20% detergent loading dose (compared to the normal one), in order to avoid detergent waste.

**DAILY
30'**

DAILY WASH 40°C – FAST 44'

A complete washing cycle (wash, rinse and spin), able to wash in approximately 44 minutes:

- a maximum load of 3/3,5 kg;
- lightly soiled fabrics (cotton and mixed fabrics)

We recommend, with this programme, a 30% detergent loading dose (compared to the normal one), in order to avoid detergent waste.

44'

SPECIAL "RINSE" PROGRAMME

This programme carries out three rinses with a intermediate spin (which can be reduced or excluded by using the correct button). It can be used for rinsing any type of fabric, eg. use after hand-washing.



SPECIAL "SPIN" PROGRAMME

Programme "SPIN" carries out a maximum spin (which can be reduced by using the correct button).



DRAIN ONLY

This programme drains out the water.



WOOLMARK PROGRAMME

A programme dedicated to washing fabrics labelled with the woolmark . The cycle comprises of alternate periods of activity and pauses. The programme has a maximum temperature of 40° and concludes with 3 rinses and a short spin.



SPECIAL “HAND WASH”

This washing machine also has a gentle Hand Wash programme cycle. This programme allows a complete washing cycle for garments specified as “Hand Wash only” on the fabric care label. The programme has a temperature of 30°C and concludes with 3 rinses and a slow spin.



SPORTS

Hoover has given sports items their own wash care programme. The washing machine has a unique Sportswear programme. It is specially designed to wash mixed sportswear fabrics that cannot be washed on hotter programmes and is designed to remove the soil and staining created by participation in sports activities. This programme washes at a cool 30°C, rinses and spins slowly for the best care of your heavily soiled, delicate garments.

Sports

MIXED AND SYNTHETIC FABRICS

The main wash and the rinse gives best results thanks to the rotation rhythms of the drum and to the water levels.
A gentle spin will mean that the fabrics become less creased.

MIXED

Auto half load

The washing machine is fitted with a self adjusting water level system.

This system enables the machine to use the amount of water needed to wash and rinse the laundry in relation to the particular load.

This results in a reduction of the water and electricity used, without in any way compromising the washing and rinsing performance.

In fact the amount of water and electricity used will always be appropriate for the clothes load.

The washing machine automatically ensures excellent washing results at minimum cost whilst respecting the environment .

Detergent drawer

P

The detergent drawer is split into 3 compartments:

- the compartment labelled "1" is for prewash detergent;
- the compartment labelled "☼" is for special additives, fabric softeners, fragrances, starch, brighteners etc;
- the compartment labelled "2" is for main wash detergent.

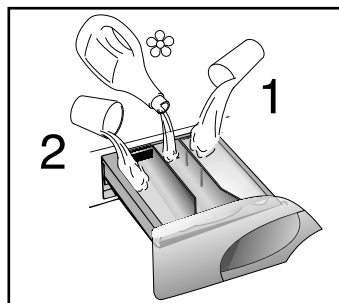

NOTE:

Some Detergents are Difficult to utilise. Ensure to use an in drum dispenser if recommended by the detergent Manufacturer.

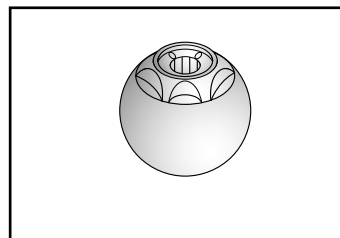

Note: only put liquid products in the compartment labelled “ ☼ ”. The machine is programmed to automatically take up additives during the final rinse stage for all wash cycles.

Detergents, washing aids and amounts to use

Choice of detergent

General purpose detergents

- **Powder detergents**, for a thorough wash, with bleaching agent, particularly suitable for use in hot wash programmes (60°C and over), for heavily soiled and stained laundry.
- **Liquid detergents**, particularly suitable for grease stains, such as greasy skin marks, cosmetics and oil.
These detergents are not suitable for washing stained laundry, as they do not contain bleach.
- **Biological detergents**, not all the products available give a really thorough wash.

Additional laundry aids

- **Water softener**, means less detergent can be used where water hardness is classed as hard to very hard.
- **Prewash substances**, for the programmed treatment of stains prior to the main wash. Using them means the subsequent wash can be at a low temperature or with bleach-free detergents.
- **Fabric softener**, prevents static build-up in synthetic fabrics and softens fabrics. If you own a tumble dryer, clothes are softened even without the use of a fabric softener.

Do not put solvents in the washing machine!

Keep detergents and other laundry products out of children's reach.

Before pouring in the detergent check that there are no foreign bodies in the detergent drawer.

Dosage details are usually shown on the detergent packaging. Follow those instructions.

Dosages

Only use detergents which are suitable for use in a washing machine.

You will obtain the best results from your wash with the minimum use of chemical products and the best care for your laundry if you take into consideration the degree of soiling as well as the type of detergent to choose.

The amount of detergent to use depends on:

- water hardness: depending on the hardness of the water and the type of detergent used, it is possible to reduce the amount of detergent.
- the degree of soiling: it is possible to reduce the amount of detergent used depending on the degree of soiling.
- amount of laundry: it is possible to reduce the amount of detergent when washing only a small amount of laundry.

Dosage for powder detergent

For normal and low concentration detergents: for normally soiled laundry choose a programme without prewash.

Put the detergent in compartment “2” of the drawer.

For heavily soiled laundry, choose a programme with prewash.

Put 1/4 of the detergent in compartment “1”, 3/4 in compartment “2” of the drawer.

When using water softeners, first put in the detergent, then add the softener to compartment “2”.

For highly concentrated detergents not in single dose format, follow what is shown on pack exactly as regards type and amount of dosage.

To avoid the difficulty of checking if the detergent has been taken up, use the dosage aids provided in the detergent packaging.

Liquid detergent dosage

Liquid detergents may be used in accordance with the instructions on the relevant packaging, for all programmes without prewash, by using the special container which is placed in the drum or, for those models that have it, in the special insert for liquid detergents.

Useful advice for users

Tips on using your domestic appliance in the most environmentally-friendly and economical way

Do a full load in your washing machine

To prevent any possible waste of energy, water or detergent we recommend that you put a full load in your washing machine, not exceed the recommended maximum load size. Up to 50% energy saving can be made with one full load compared to two half load washes

When is prewashing really needed?

Only with particularly dirty loads!

Energy savings of 5 to 15% are made by not selecting the prewash option for normal soiled laundry.

Which wash temperature should you choose?

Using stain removers before machine washing reduces the need to wash at temperatures over 60°C.

Energy savings of up to 50% can be made by using a 60°C wash temperature rather than 90°C

Main wash

Sorting the laundry

- It is recommended you wash only items which are machine washable with water and detergent and not dry-clean items.
- If you need to wash rugs, bedspreads or other heavy items, it is best not to spin them.
- Sort the laundry according to fabric type, degree of soiling and wash temperature: Always follow the wash care advice on the garment label for the most suitable care and treatment of the laundry

Laundry for hot wash \ 95° /

Coloured, easy-care materials \ 60° / \ 50° / \ 40° /

Delicates and wool \ 40° / \ 30° /

Wash by hand 

Items labelled with the following symbol are not suitable for machine washing:

Dry clean 

For very delicate items, such as net curtains, underwear, tights etc., you are advised to use a laundry net or wash bag.

- Woollen items must be labelled with the "Pure New Wool" symbol to be washed in the machine, and must also be labelled "non-matting" or "machine washable".
- Colour often leaks from new coloured items.

This can then colour other lighter items being washed.

We therefore recommend that coloured items should be washed for the first time separately.

For future washes, colourfast items can only be washed with whites up to 40°C.

Note: when sorting laundry

- check there are no metal objects in the laundry (such as paper clips, safety pins, pins, coins etc...);
- button up pillowcases, fasten zips, hook & eye fasteners, belts and long dressing gown cords;
- remove curtain hooks;
- pay close attention to the labels on items
- if you notice stubborn stains whilst sorting the laundry, remove them using a special detergent or a special stain remover.

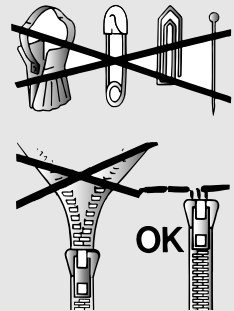

- We recommend that you do not do a full load of towelling items only as these become too heavy since they absorb a lot of water.

The correct way to wash

Preparing the laundry

A) Select the laundry.

Loading the laundry

B) Open the porthole.

C) Put the laundry in the washing machine.

Close the porthole again, ensuring that no items of laundry are obstructing the lock.

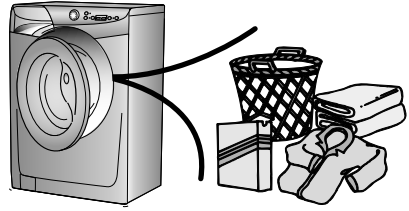

Putting detergent in machine

D) Open the drawer, choose the detergent and put in the correct amount, according to the manufacturer's instructions and the advice on page 18.

Add any other laundry aids (see page 18). Close the drawer again.

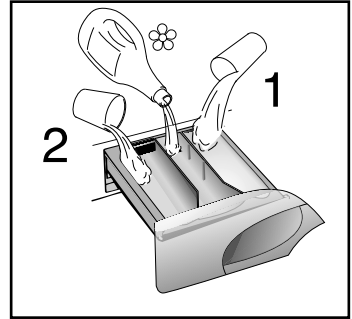

Selecting the wash programme

Refer to the programme guide or the programme descriptions on the machine to select the most suitable programme.

Turning the selector knob, the required programme is activated.

Press additional function buttons (if required).

Check that the tap is turned on and that the discharge hose is positioned correctly.

Press the **"Start/Pause"** button.

When the **"Start/Pause"** button is pressed the machine sets the working sequence in motion.

The programme carries out with the programme selector stationary on the selected programme till cycle ends.

Warning: If there is any break in the power supply while the machine is operating, a special memory stores the selected programme and, when the power is restored, it continues where it left off.

When the programme is finished

The word "End" will appear on the display.

Wait for the door lock to be released (about 2 minutes after the programme has finished).

The **"Door Security"** indicator light will go out.

Switch off the machine by turning the programme selector on the **"OFF"** position. Open the door and remove the laundry. Turn off the tap.

Cleaning and routine maintenance

Do not use alcohol-based scourers and / or thinners on the outside of your washing machine, just a wipe with a damp cloth will suffice. The washing machine needs very little maintenance:

- Cleaning the drawer compartments.
- Cleaning the filter.
- Cleaning the door glass.

Cleaning the drawer compartments

Even if it is not strictly necessary, it is good to clean the compartments for bleaching detergents and additives occasionally.

- To do this you just need to pull them out firmly, but without forcing them.
- Clean everything in the compartment under running water.
- Put everything back in its proper place.

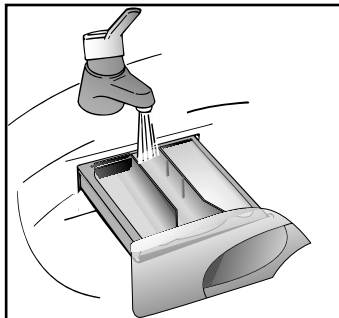

Cleaning the filter

The washing machine is fitted with a special filter for handling large deposits which could block the discharge hose (coins, buttons etc.) and which can, therefore, be easily retrieved.

We recommend that the filter be cleaned at least once a month.

The cleaning operation is as follows:

- Open the flap
- Only available on certain models:
Pull out the corrugated hose, remove the stopper and drain the water into a container.
- Before removing the filter, place an absorbent towel below the filter cap to collect the small amount of water likely to be inside the pump
- Turn the filter anti-clockwise until it stops in the vertical position.
Remove and clean.
- After cleaning, replace by turning the notch on the end of the filter clockwise. Then follow all procedures described above in reverse order.

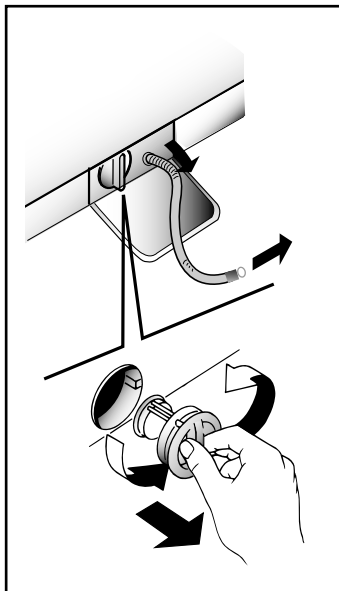

Attention: if the filter needs cleaning while there is washing still in the drum, follow the instructions on the following page to empty the water. This will prevent excessive loss of water via the filter.

Cleaning the door glass

Regularly clean the door glass with a damp cloth. A build up of soiling and residues from the water may result in water leaking from the door.

Do not use abrasive cleaners as they can scratch the surface.

Transporting the appliance or long periods when appliance is not in use

If the appliance is being transported or is out of use for long periods in unheated places, all remaining water must be completely removed from the hoses.

Ensure mains power is off, then unclip the hose and point it downwards into a basin until all the water has emptied out.

When finished, repeat the operation in the reverse order.

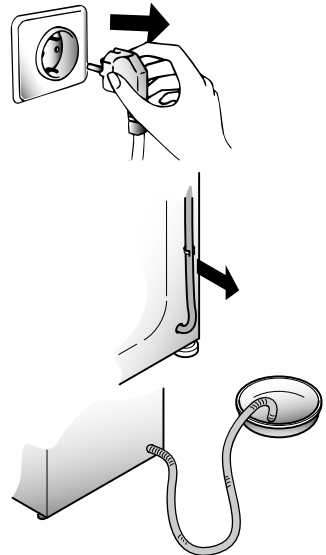

Investigating malfunctions

What might be the cause of... Defects you can remedy yourself

MALFUNCTION	CAUSE	REMEDY
1. Does not work on any programme	Plug not in socket. Not switched on. Power failure. Fuse blown. Door open.	Plug it in. Switch on. Check. Check. Close door.
2. Does not fill with water	See cause 1. Tap turned off. Programme selector not correctly positioned. Fill hoses are kinked	Check. Turn on tap. Position programme selector correctly. Straighten fill hoses
3. Water does not drain away	Kink in discharge hose. Foreign bodies in filter House drain is blocked	Straighten discharge hose. Examine filter (see pages 23-24) Clean drain
4. Water on floor around the washing machine	Leaking gasket between tap and water inlet hose. House drain is blocked Soap drawer blocked with soap residues	Replace gasket and tighten hose and tap well. Clean drain Clean soap drawer
5. Does not spin	Water has not yet drained away. "No spin" selected (certain models only).	Wait a few minutes for machine to empty. Reset button or turn "no spin" knob.
6. Machine vibrates a lot during spin	Washing machine not completely level. Transit brackets not removed yet. Load not distributed evenly.	Adjust the special adjustable feet. Remove transit brackets. Rearrange the laundry evenly.
7. Door will not open	Two minutes have not elapsed since the programme finished.	Wait two minutes.
8. Display reads error 0, 1, 5, 7, 8, 9	–	Call service.
9. Display reads error 2	No water fill.	Check water supplies are on.
10. Display reads error 3	No pump out.	Check drain is clear. Check drain hose is not kinked.
11. Display reads error 4	Machine overfilled with water.	Turn off water supply to machine. Call service.

The machine makes a different noise when spinning! This is because it has a brush motor for better performance.

Only a small level of water can be seen in the drum! This is because new machines do not use much water, yet achieve the same standard of washing and rinsing.

Note:

The use of environmentally-friendly, phosphate-free detergents can have the following effects:

- waste water from rinsing may be cloudier because of the presence of zeolites held in suspension, without the rinse performance being adversely affected;
- presence of white powder (zeolites) on laundry after washing, which is not absorbed by the fabric and does not alter the colour of the fabric.
- The presence of foam in the final rinsing water is not necessarily an indication of poor rinsing.
- Anionic surfactants used in washing detergent formulae often prove to be difficult to remove from the laundry itself and, even in small quantities, can still cause considerable foam production.
- Carrying out more rinse cycles does not serve any purpose in such cases.

CUSTOMER SERVICE AND GUARANTEE

Your new appliance is fully guaranteed by the manufacturer for 12 months against electrical/mechanical breakdown excluding:

A. Any faults which occur due to bad installation or misuse of the machine.

B. Any faults which occur due to repair of, or interference with, the machine by any person not authorised by the manufacturer to carry out service.

C. Any faults which arise from parts fitted to the machine which are not the manufacturers original parts.

D. Any faults arising from non-domestic use or unusual or abnormal use of the machine.

E. Any faults arising from operation at an incorrect voltage.

F. Any faults arising from incorrect operation of the machine.

The guarantee applies to Gt. Britain and Northern Ireland only, and is an addition to your statutory rights.

After Sales Service

If, having investigated the possible malfunctions on the chart on the previous page, you believe the appliance is not working correctly, please call our After Sales Service dept. on telephone number:

Gias Service	-	Tel: 08444 995599
Support Service		(Eire 0818 200021)

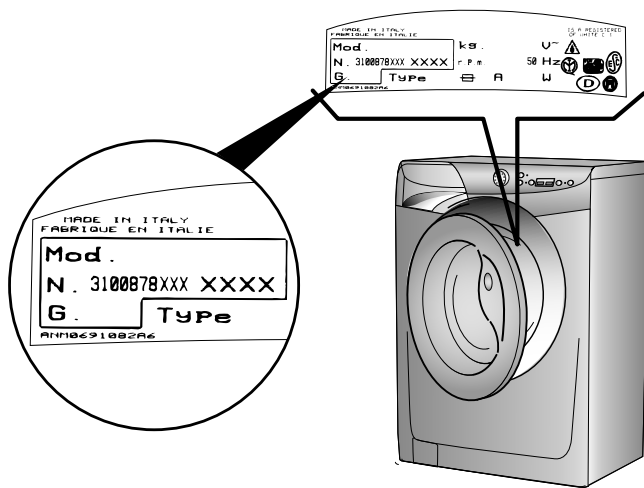

Fig. 2

Technical data

- Max. load of dry laundry
- Water pressure

7 kg
0,05 ÷ 0,8 MPa

8 kg
0,05 ÷ 0,8 MPa

Measurements

- Width
- Depth
- Height

60 cm
52 cm
85 cm

60 cm
52 cm
85 cm

NB: For specifications regarding electrical data, see the data panel on the front of the washing machine (porthole area) - as shown in diagram above.



Appliance complies with European Directives 73/23/EEC and 89/336/EEC, replaced by 2006/95/EC and 2004/108/EC, and subsequent amendments.

SETTING UP + INSTALLATION

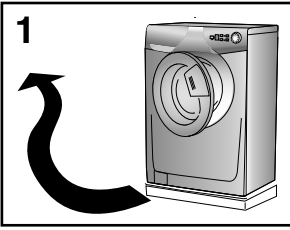

Remove the polystyrene base and place the machine near its permanent position (diagram 1).

Carefully cut through the hose retaining clip at the rear of the appliance (diagram 2).

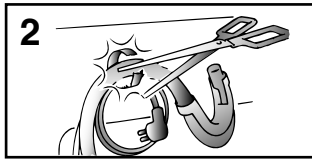

Remove the 2 or 4 fixing screws marked (A) and remove the 2 or 4 spacers marked (B) (diagram 3).

Cover the 2 or 4 holes using the caps provided in the instruction booklet pack (diagram 4).

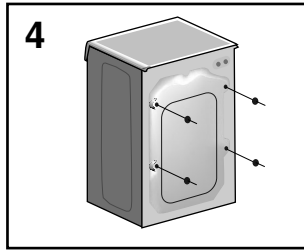
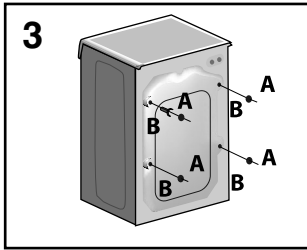

WARNING:

DO NOT LEAVE THE PACKAGING WITHIN REACH OF CHILDREN AS IT IS A POTENTIAL SOURCE OF DANGER.

Apply the insulation sheet of corrugated material to the base as shown.

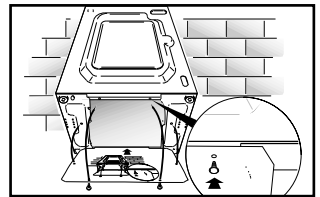

Use the 4 feet to level the machine with the floor:

- Turn the nut clockwise to release the screw adjuster on the foot.
- Rotate the foot to raise or lower it until it stands firmly on the ground.
- Lock the foot in position by turning the nut anti-clockwise until it comes up against the bottom of the machine.

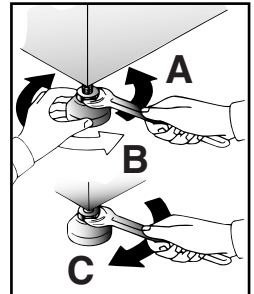

Note: we recommend you keep the screws to immobilise the machine for future transit.

The Manufacturers will not be responsible for any possible damage to the machine caused by not following the rules relating to releasing the mechanism. The user is responsible for all costs of installation.

Water connection

The appliance must be connected to the water mains using new hose-sets.

The old hose-sets should not be re-used.

The machine has an inlet hose with 3/4" B.S.P threaded end connection to attach between the threaded connector on the appliance and the cold water supply.

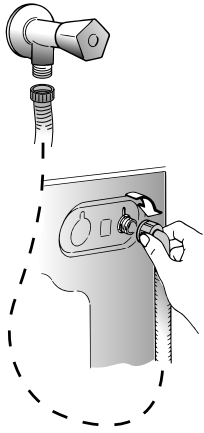

This machine only uses cold water, therefore only one hose is needed to connect to the cold water supply. Do not connect to the hot supply. Cold fill is an energy efficient system. Only the water required for the washing is heated. There is no loss of heat in the pipeline from a hot water tank or boiler to the machine.

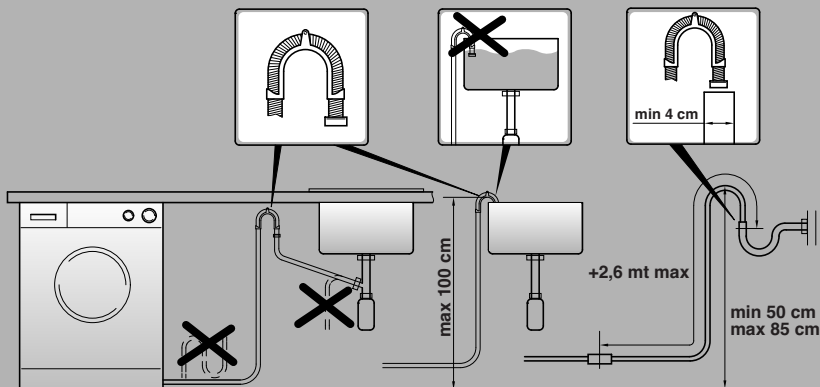

Note: it is advisable to turn off the tap after each wash to isolate the washing machine from the water supply.

For the washing machine to function properly the terminal end of the discharge hose (mouth) must be at a minimum of 50 cm and a maximum of 85 cm from the ground.

ELECTRICAL CONNECTIONS

After installation, the appliance must be positioned so that the plug is accessible.

If the plug we supply does not fit

CUT IT OFF AND DESTROY IT!

You can't use it on other appliances, and the exposed wires could be dangerous if plugged in.

To fit a replacement plug, proceed as follows:

Connect

green and yellow wire

to the terminal in the plug

marked with the letter E,
OR marked
with the symbol, 
OR coloured green,
OR coloured green and yellow.

blue wire

marked N
OR coloured black.

brown wire

marked L
OR coloured red.

WARNING

This appliance must be earthed

Fuses and plugs

This appliance should be used only on a socket with a minimum rating of 13 Amp.

Our ready-fitted plug is already equipped with a 13 amp fuse which is BS 1362 ASTA approved. Any replacement should be exactly the same.

If the fuse cover is lost, do not use the plug until it is replaced. A correct replacement fuse cover (obtainable from your local retailer) must be the same colour as shown or named on the insert on the base of the plug.

The manufacturer declines all responsibility in the event of any printing mistakes in this booklet. The manufacturer also reserves the right to make appropriate modifications to its products without changing the essential characteristics.

HOOVER®

This appliance is marked according to the European directive 2002/96/EC on Waste Electrical and Electronic Equipment (WEEE).

By ensuring this product is disposed of correctly, you will help prevent potential negative consequences for the environment and human health, which could otherwise be caused by inappropriate waste handling of this product.

The symbol on the product indicates that this product may not be treated as household waste. Instead it shall be handed over to the applicable collection point for the recycling of electrical and electronic equipment. Disposal must be carried out in accordance with local environmental regulations for waste disposal.

For more detailed information about treatment, recovery and recycling of this product, please contact your local city office, your household waste disposal service or the shop where you purchased the product.



EN

12.05 - 430003232