

Alderbury 3ft Bed

Assembly Instructions - Please keep for future reference

102/3206

102/8311

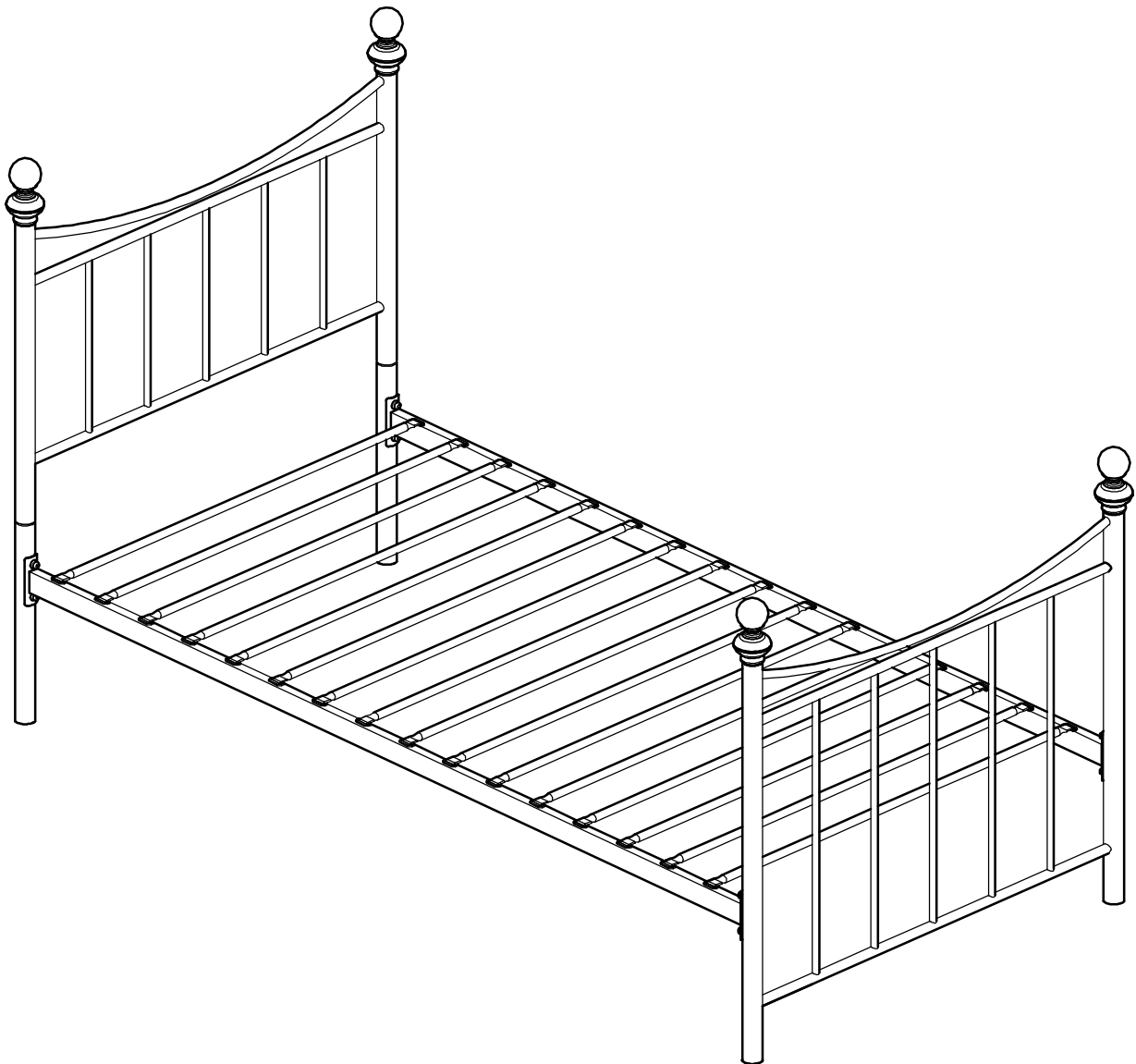

Dimensions

Width - 99.2cm

Depth - 202.3cm

Height - 116.5cm

Important – Please read these instructions fully before starting assembly

If you need help or have damaged or missing parts, call the **Customer Helpline: 0845 6400800**



Safety and Care Advice

Important – Please read these instructions fully before starting assembly

- Check you have all the components and tools listed on pages 2 and 3.
- Remove all fittings from the plastic bags and separate them into their groups.
- Keep children and animals away from the work area, small parts could choke if swallowed.
- Make sure you have enough space to layout the parts before starting.

- As you unpack and prepare for assembly, clear an area for assembly. The parts should be placed on a carpeted or padded area to protect them from damage.
- Parts of the assembly will be easier with 2 or 3 people.
- Do not discard any of the packaging until you have checked that you have all the parts and pack of fittings.



- We do not recommend the use of power drill/drivers **for inserting screws**, as this could damage the unit. Only use hand screwdrivers.
- To ensure an easier assembly, we strongly advise that all fittings are only finger tightened during initial assembly. Only upon completion of the assembly should all fixing points be fully tightened.

Care and maintenance

- Only clean using a damp cloth and mild detergent, do not use bleach or abrasive cleaners.
- From time to time check that there are no loose screws on this unit.
- This product should not be discarded with household waste. Take to your local authority waste disposal centre.

Components - Panels

If you have damaged or missing components, call the **Customer Helpline: 0845 6400800**

Please check you have all the panels listed below

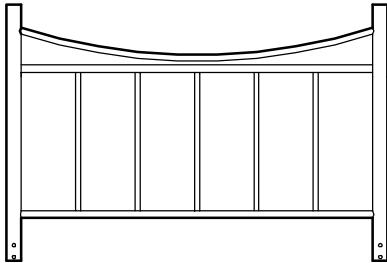

1 Headboard frame
(95.7 x 66cm)

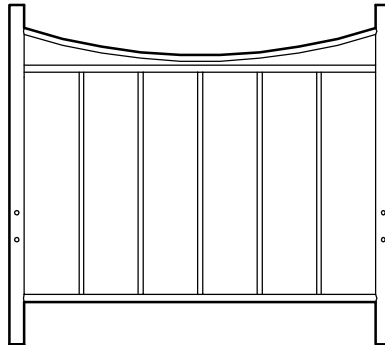

2 Footboard frame
(95.7 x 87.5cm)

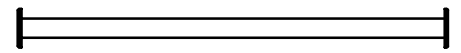

3 Side rail x 2 (192.2 x 9cm)

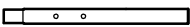

4 Headboard post x 2
(dia3.8 x 47.5cm)

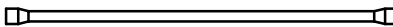

5 Slat x 16 (92.2 x 3.2cm)

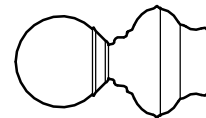





6 Finial x 4 (12.9 x 7.3cm)

Components - Fittings

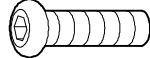
Please check you have all the fittings listed below

Note: The quantities below are the correct amount to complete the assembly. In some cases more fittings may be supplied than are required.

A  16mm Bolt x 4	B  30mm Bolt x 8	C  Plain washer x 8
D  Spring washer x 8	E  Small hex key x 1	F  Large hex key x 1

Ruler - Use this ruler to help correctly identify the screws

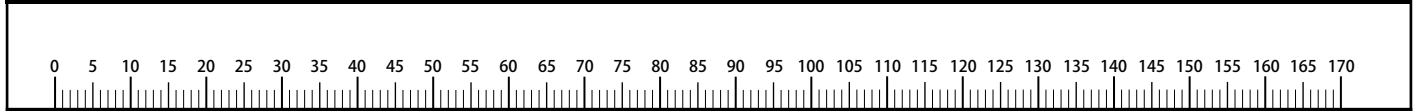

Assembly Instructions

Step 1

Assemble headboard

Assemble headboard posts **4** onto headboard frame **1** using bolts **A** and secure tightly.

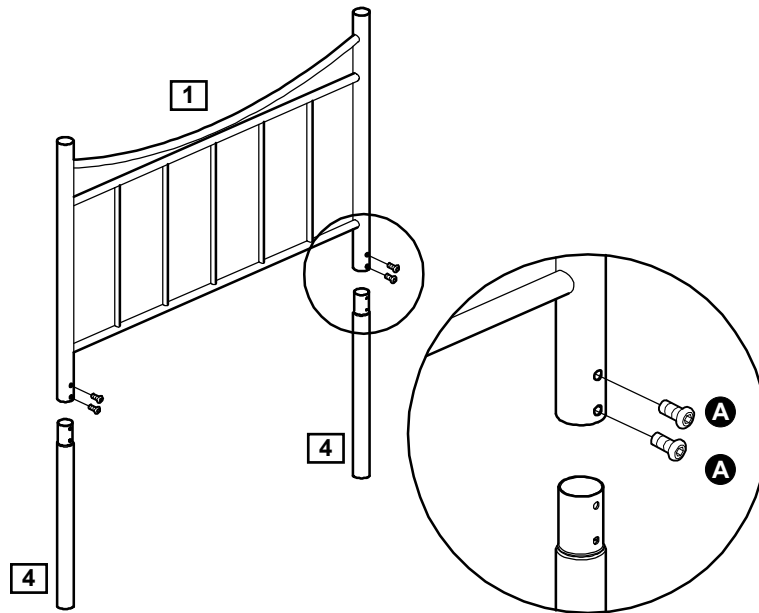

Step 2

Assemble side rails

Three people are needed here.

Assemble side rails **3** to headboard post **4** and footboard frame **2** using bolts **B**, spring washers **D** and plain washers **C**.

Note: Do not tighten bolts until fully assembled.

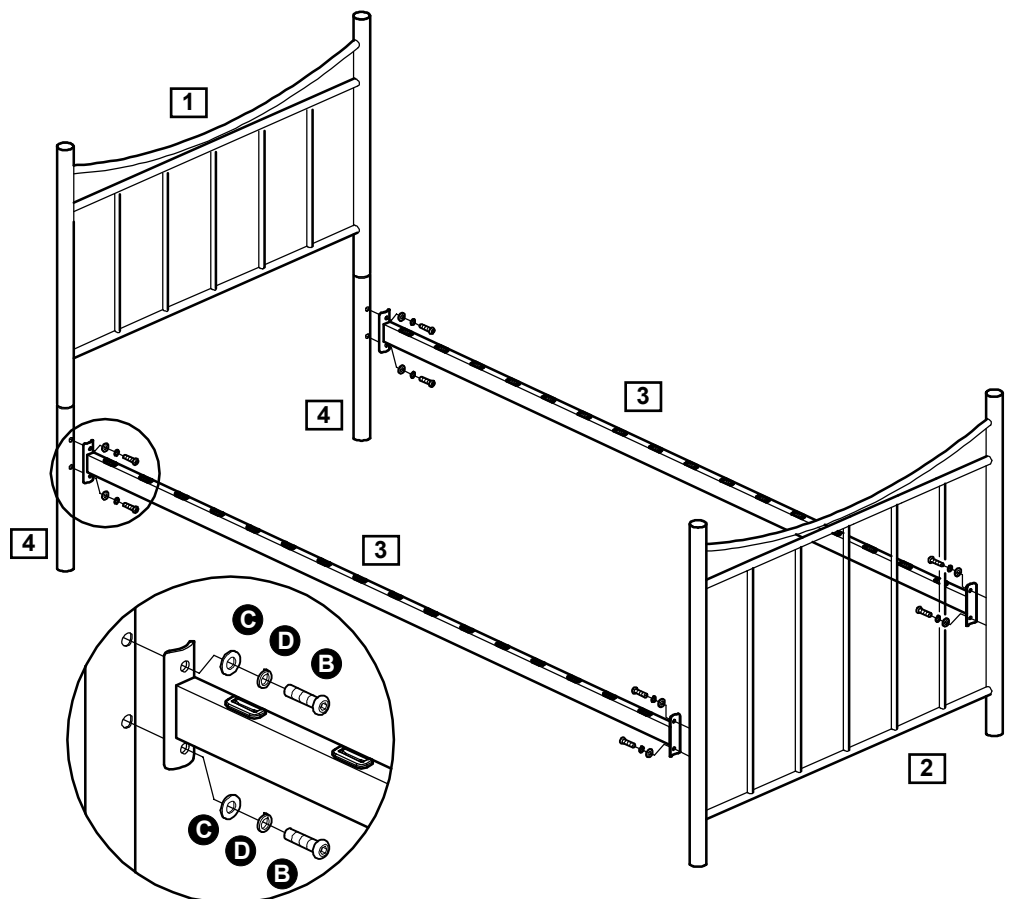

Assembly Instructions

Step 3

Assemble slats

Insert slats **5** to the side rails.

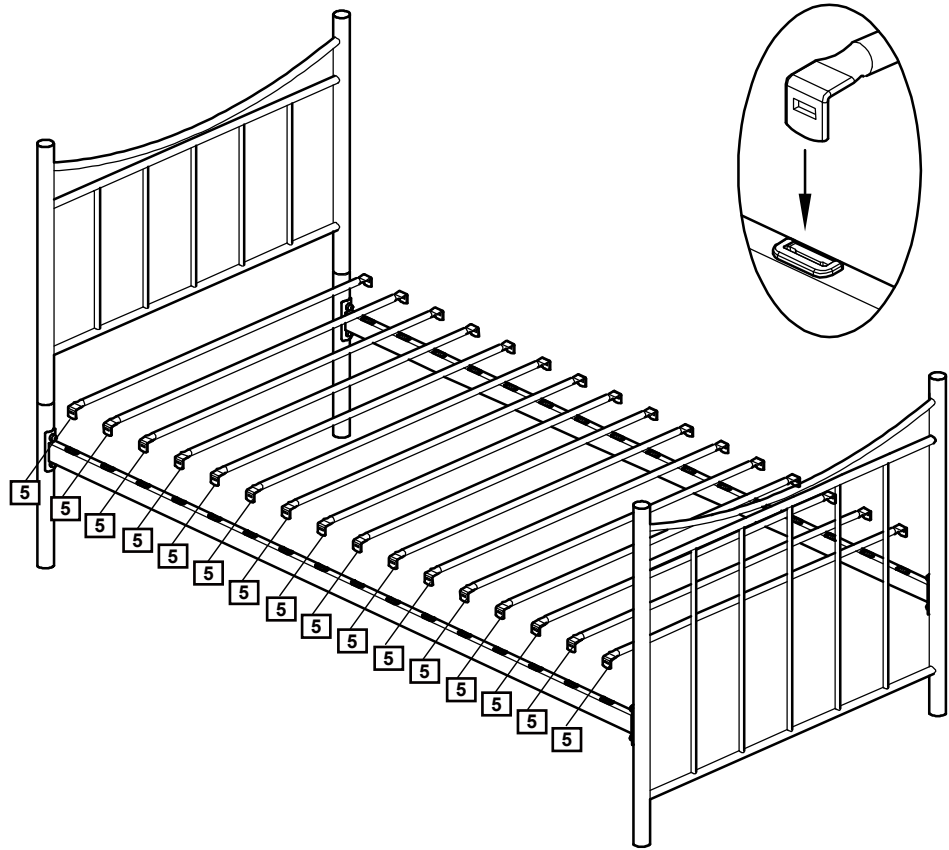

Step 4

Assemble finial

Insert finials **6** into the headboard frame and footboard frame.

Note: Re-tighten all the bolts.

Assembly is complete.

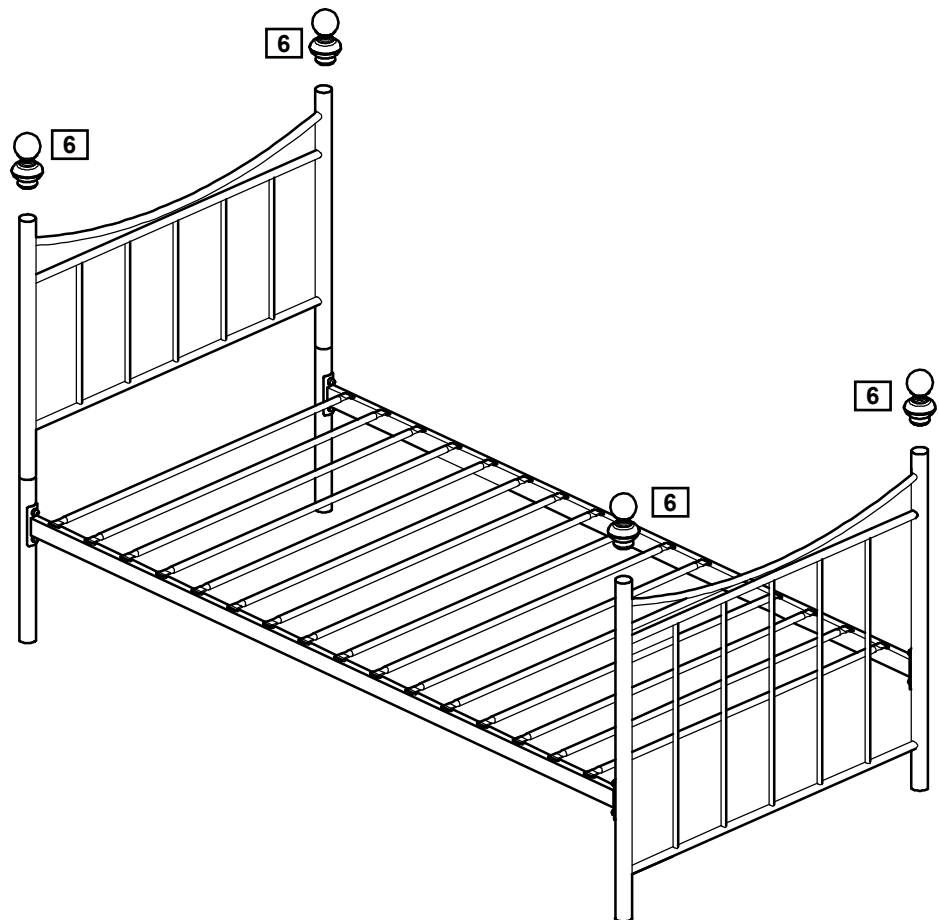

If you need help or have damaged or missing parts, call the **Customer Helpline: 0845 6400800**