

# BUSH

## Instruction manual

T-1001C





You'll soon be enjoying your new Bush Portable DVD Player.

It all begins here, with your instructions. Don't worry, there's nothing too technical coming up. Just simple, step-by-step guidance to get you up and running quickly. Sound good? Then let's get started.

## Help and Guidance

We're here to help you get the most from your Bush Portable DVD Player. Should you require any guidance, a simple solution can often be found online at:

[www.bush-support.com](http://www.bush-support.com)

If you still require further assistance, call one of our experts on **0345 604 0105**.

If you require any technical guidance or find that your product is not operating as intended, a simple solution can often be found in the **Troubleshooting**

# Contents

## 1 Safety information

Safety information 6

## 2 Getting to know your PORTABLE DVD PLAYER

Ready? Let's begin 12

Accessories 12

Main Unit 13

## 3 Using your PORTABLE DVD PLAYER

Remote control unit 16

SETUP Menu Setting 19

## 4 Other information

Technical specification 26

## 5 Product support

Troubleshooting 30

Help and assistance 31



# Safety information 1





## Safety information

**Important** - Please read these instructions fully before installing or operating

Warning: To reduce the risk of electric shock, do not remove the cover or back. There are no user-serviceable parts inside. Refer servicing to qualified personnel.

Warning: To prevent fire or electric shock hazard, do not expose the unit to rain or moisture.

Do not expose the Adaptor and portable DVD to water (dripping or splashing) and no objects filled with liquids, such as vases, should be placed on the unit.

Keep the portable DVD away from direct sunlight and heat source such as radiators or stoves.

Do not block the ventilation openings. Slots and openings on the unit are provided for ventilation. The openings should never be blocked by placing your portable DVD on a cushion, sofa or other similar surface.

Do not place the portable DVD on unstable cart, stand, tripod, bracket or table. The unit may fall, resulting in possible damage or injury.

Never place heavy or sharp objects on the LCD panel or frame.

Only use the AC adaptor included with portable DVD. Using any other adaptor will void your warranty.

The plug of AC adaptor is used as the disconnect device, the disconnect device shall remain readily operable.

Unplug the power from the outlet when the unit is not in use.

Attention should be drawn to the environmental aspects of battery disposal.

**CAUTION:** Danger of explosion if battery is incorrectly replaced. Replace only with the same or equivalent type.

**WARNING:** The battery (battery or batteries or battery pack) shall not be exposed to excessive heat such as sunshine, fire or the like.

**WARNING:** Excessive sound pressure from earphones or headphones can cause hearing loss.

If you require any technical guidance or find that your product is not operating as intended, a simple solution can often be found in the **Troubleshooting**



# Safety information

**Important** - Please read these instructions fully before installing or operating

WARNING: Only use attachments/accessories specified provided by the manufacturer, the portable DVD is supplied by AC adapter, the AC adapter is used as disconnect device, the disconnect device shall remain readily operable.

Caution: Danger of explosion if battery is incorrectly replaced, replaced only with the same or equivalent type (Lithium battery)



Use only power supplies listed in the user instructions.  
Adapter model: PEA-090100VG  
Made By: Shenzhen Mass Power Electronics Limited



This equipment is a Class II or double insulated electrical appliance. It has been designed in such a way that it does not require a safety connection to electrical earth.



To prevent possible hearing damage. do not listen at high volume levels for long periods.  
Fully understand user manual before use.  
Ensure your player at low volume levels or power off before you leaving.



Manufactured under license from Dolby Laboratories Dolby and the double-D symbol are trademarks of Dolby Laboratories



- Audio and Video  
Disc size 12cm Single side, single layer / single side, double layer PAL and NTSC DVD disc Playback time 135min / 240min max

This DVD Player is designed and manufactured to respond to the Region Management Information that is recorded on a DVD disc. If the Region number described on the DVD disc does not correspond to the Region number of this DVD Player, this DVD player can not play that disc

The Region number of this DVD player is





# Safety information

**Important** - Please read these instructions fully before installing or operating

## Safety Precautions



Warning: This digital video disc player employs a laser system.

Use of controls, adjustments, or the performance of procedures other than those specified herein may result in hazardous radiation Exposure.

Warning: To prevent direct exposure to laser beam, do not open the enclosure. Visible laser radiation when open.

Warning: Never stare directly into the laser beam.

Caution: Do not install this product in a confined space such as a book case or similar unit.

Warning: when the unit is used by a child, parents must make sure to let the child understand all contents in the instruction book how to use the battery correctly all the time.

Warning: when the battery overheats, swells or dours, please stop using the battery and contact the service centre for replacement.

Warning: do not charge the battery in a place with insufficient ventilation such as: mattress, sofa, cushion, soft mat.....

Warning: we will not take any responsibility if the user incorrectly uses the battery, not following our warning instruction label on the battery case.

Warning: more than 250mm USB extension cord is prohibited to use for the USB port

**WARNING:**

Do not ingest the battery, Chemical Burn Hazard (The remote control supplied with) This product contains a coin/button cell battery.

If the coin/button cell battery is swallowed, it can cause severe internal burns in just 2 hours and can lead to death.

Keep new and used batteries away from children.

If the battery compartment does not close securely, stop using the product and keep it away from children.

If you think the battery might have been swallowed or placed inside any part of the body, seek immediate medical attention.

If you require any technical guidance or find that your product is not operating as intended, a simple solution can often be found in the **Troubleshooting**





## Safety information

**Important** - Please read these instructions fully before installing or operating

### Notes on Copyrights:

It is forbidden by law to copy, broadcast, show, broadcast via cable, play in public, or rent copyrighted material without permission.

This product features the copy protection function developed by Macrovision. Copy protection signals are recorded on some discs. When recording and playing the pictures of these discs picture noise will appear. This product incorporates copyright protection technology that is protected by method claims of certain U.S. Patents and other intellectual property rights owned by Macrovision Corporation and other rights owners. Use of this copyright protection technology must be authorized by Macrovision Corporation, and is intended for home and other limited viewing uses only unless otherwise authorized by macrovision Corporation. Reverse engineering or disassembly is prohibited.

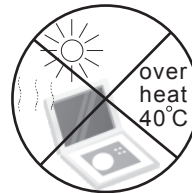
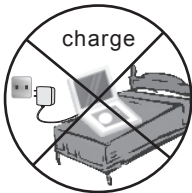



# Getting to know your PORTABLE DVD PLAYER

# 2



# Getting to know your PORTABLE DVD PLAYER

You'll be up and running in no time

## Ready? Let's begin...

Please read these instructions carefully. They contain important information which will help you get the best from your product and ensure safe and correct installation and operation.

If you require any further assistance, our technical experts are happy to help. For full details, refer to the product support section at the end of these instructions.

### Accessories

1. Remote control
2. AC adaptor
3. Car charger
4. User manual

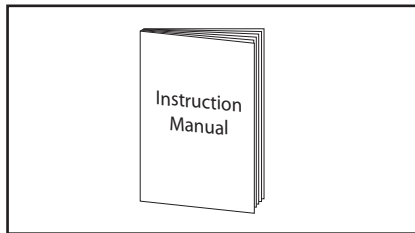
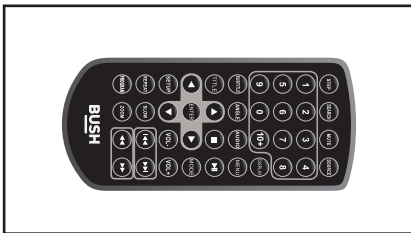
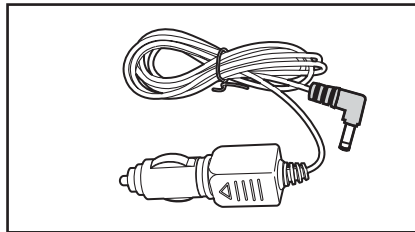
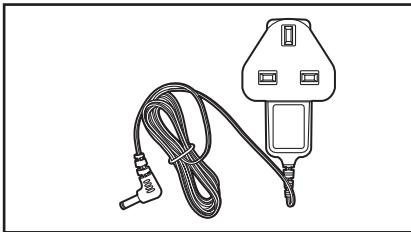

If you require any technical guidance or find that your product is not operating as intended, a simple solution can often be found in the **Troubleshooting**

# Getting to know your PORTABLE DVD PLAYER

You'll be up and running in no time

## Main Unit

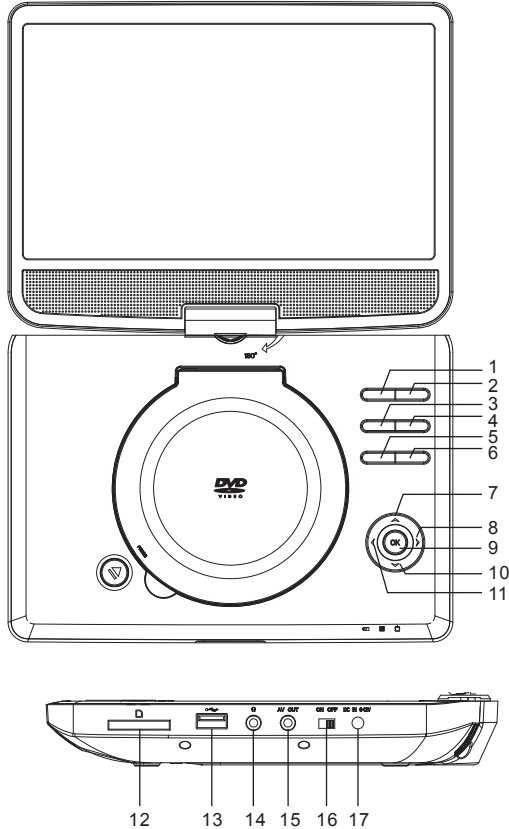

1. VOL-
2. VOL+
3. MENU
4. PLAY/PAUSE
5. SETUP
6. SOURCE
7. UP/Prev
8. Right/Fast forward

9. OK
10. Down/Next
11. Left/Fast reverse
12. SD/MMC
13. USB
14. Earphone Socket
15. AV OUT
16. ON/OFF
17. DC IN 9-12V

section of these instructions, or online at [www.bush-support.com](http://www.bush-support.com) If you still require further assistance, call one of our experts on 0345 604 0105.



# Using your PORTABLE DVD PLAYER

3



# Using your PORTABLE DVD PLAYER

Let's get started

## Remote control unit

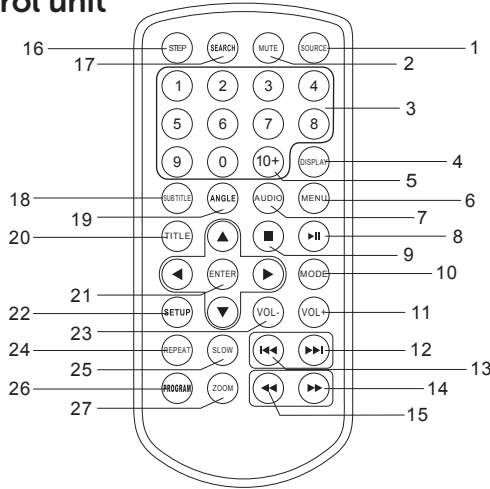

1. SOURCE  
DVD/USB/CARD.

2. MUTE  
Disable Audio output.

3.0-9 NUMBER BUTTON  
Selects numbered items in a menu.

4.DISPLAY  
To display the playtime and status information.

5.10+ BUTTON  
In order to select a track 10 or greater, first press 10+, For example; select track 12, first press 10+, and then press number 2 button.

6. MENU  
Return to DVD root menu(DVD).

7.AUDIO  
DVD:Press AUDIO repeatedly during playback to hear a different audio language or audio track, if available.  
CD: Press AUDIO repeatedly during playback to hear a different audio channel ( Left,Right,Mix,Stereo).

If you require any technical guidance or find that your product is not operating as intended, a simple solution can often be found in the **Troubleshooting**



# Using your PORTABLE DVD PLAYER

Let's get started

## 8.PLAY/PAUSE

Press PLAY/PAUSE once to pause playback, pressing PLAY/PAUSE second time will resume the playback.

## 9.STOP

When this button is pressed once, the unit records the stopped point,from where playback will resume if PLAY(▶) is pressed afterwards. But if STOP button is pressed again instead of PLAY(▶) button, there will be no resume function.

## 10.MODE

Set LCD parameter(adjust bightness, contrast,and saturation).

## 11.VOL+

## 23.VOL-

Adjust volume.

## 12.Forward Skip

Go to next chapter/ track.

## 13.Reverse Skip

Go to previous chapter/ track to the beginning.

## 14. ▶▶ BUTTON

Press ▶▶ BUTTON allow skipping ahead at 5-level speed(X2-> X4->X8->X16->X32->PLAY), press PLAY button return to normal playback.

## 15. ◀◀ BUTTON

Press ◀◀ BUTTON allow skipping back at 5-level speed(X2->X4->X8->X16->X32->PLAY), press PLAY button return to normal playback.

## 16.STEP

Step the motion in DVD mode.

## 17.SEARCH

Goto time point , title or chapter you want in DVD Mode.

## 18.SUBTITLE

Press SUBTITLE repeatedly during playback to hear a different subtitle languages.

## 19.ANGLE

DVD:Press ANGLE will change the view angle, on DVDs that support this feature.

section of these instructions, or online at [www.bush-support.com](http://www.bush-support.com) If you still require further assistance, call one of our experts on 0345 604 0105.

# Using your PORTABLE DVD PLAYER

Let's get started

## 20.TITLE

Return to DVD title menu

## 21.ENTER

Confirms menu selection..

## 22.SETUP

Accesses or removes setup menu.

## 24.REPEAT

Press REPEAT during playback to select a desired repeat mode.

DVD: you can play select repeat chapter/title/off.

CD: you can select repeat single/all/off.

MP3: you can select repeat single/folder/off.

## 25.SLOW

Press Slow button repeatedly to enter slow playback, and cycle between different speeds.

The speeds are 1/2,1/4,1/8,1/16,and normal.

## 26.PROGRAM

DVD:The program function enables you to store your favourite tracks from the disc.

Press PROGRAM button ,then PROGRAM MENU will appear on screen, now you can use the number key to direct input the titles,chapters or tracks number and select PLAY option.

TO resume normal playback, press PROGRAM and select clear program option on the program menu,press PROGRAM again to exit program menu.

## 27.ZOOM

DVD: Use ZOOM to enlarge or shrink the video image.

1.Press ZOOM during playback or still playback to activate the Zoom function.

The square frame appears briefly in the right bottom of the picture.

2. Each press of the ZOOM button changes the TV screen in the following sequence:

2 x size→3 x size→4 x size→1/2 x size→1/3 x size→1/4 x size→normal size

JPEG: Use ZOOM to enlarge or shrink the picture.

1.Press 'ZOOM' .

2.Used " ►► " to enlarge,or " ◀◀ " to shorten the picture.

Use the ▲▼◀► button to move through the zoomed picture.

If you require any technical guidance or find that your product is not operating as intended, a simple solution can often be found in the **Troubleshooting**

# Using your PORTABLE DVD PLAYER

Let's get started

## SETUP Menu Setting

### General Setup Page

Press SETUP button to get the setup menu. Use direction button ▲▼◀▶ to select the preferred item. After finishing settings, press SETUP again to normal display. The following menu items can be changed:

GENERAL: selects the GENERAL PAGE menu.

AUDIO: selects the AUDIO PAGE menu.

VIDEO: selects the VIDEO PAGE menu.

PREFERENCE : selects the PREFERENCE PAGE menu.

PASSWORD: selects the PASSWORD PAGE menu.

### General Setup Page

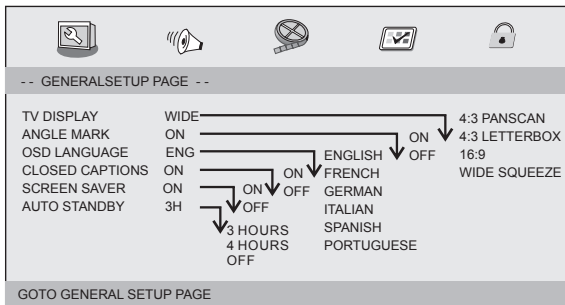

TV DISPLAY: selects the aspect ratio of the playback picture.

4:3 PANSCAN: if you have a normal TV and want both sides of the picture to be trimmed or formatted to fit your TV screen.

4:3 LETTERBOX: if you have a normal TV. In this case, a wide picture with black bands on the upper and lower portions of the TV screen will be displayed.

16:9:wide screen display.

Wide Squeeze: Set screen mode to 4:3.

Angle Mark

Displays current angle setting information on the right hand corner of the TFT screen if available on the disc.

section of these instructions, or online at [www.bush-support.com](http://www.bush-support.com) If you still require further assistance, call one of our experts on 0345 604 0105.

# Using your PORTABLE DVD PLAYER

## Let's get started

### OSD Language

You can select your own preferred language settings.

### Closed Captions

Closed captions are data that are hidden in the video signal of some discs. Before you select this function, please ensure that the disc contains closed captions information and your TV set also has this function.

### Screen Saver

This function is used to turn the screen saver On or Off

### Auto Standby

This function is used to select auto standby settings after 3 or 4 hours.

3 HOURS: the unit will turn to standby mode after 3 hours if there is no interaction from user within this period of time.

4 HOURS: the unit will turn to standby mode after 4 hours if there is no interaction from user within this period of time.

OFF: the auto standby function is disabled, and unit will stay in "on" mode even if no interaction from user..

## Audio Setup Page

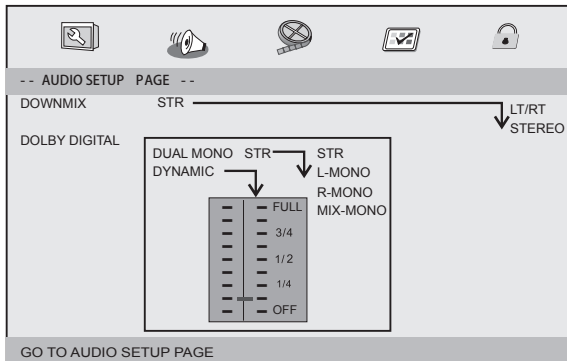

### Downmix

This options allows you to set the stereo analog output of your DVD Player.

LT/RT :Select this option if your DVD Player is connected to a Dolby Pro Logic decoder.

If you require any technical guidance or find that your product is not operating as intended, a simple solution can often be found in the **Troubleshooting**

# Using your PORTABLE DVD PLAYER

Let's get started

Stereo :Select this option when output delivers sound from only the two front speakers.

Dolby digital

The options included in Dolby Digital Setup are: 'Dual Mono ' and 'Dynamic '.

Dual Mono

Stereo:Left mono sound will send output signals to Left speaker and Right mono sound will send output signals to Right speaker.

L-Mono:Left mono sound will send output signals to Left speaker and Right speaker.

R-Mono:Right mono sound will send output signals to Left speaker and Right speaker.

Mix-Mono:Left and Right mixed mono sound will send output signals to Left and Right speakers.

Dynamic

Dynamic range compression.

## Video Setup Page

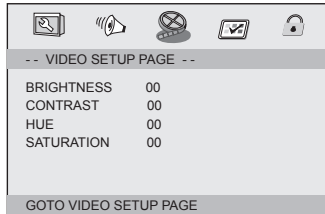

Brightness,Contrast,Hue,Saturation:setting the video quality.

## Preference Page

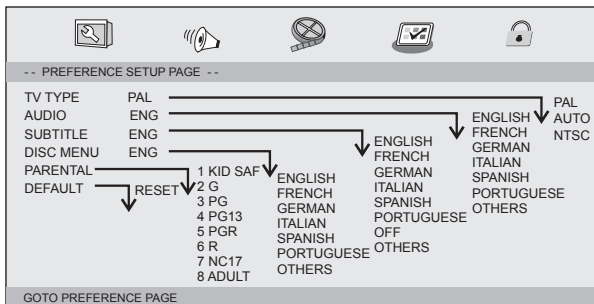

section of these instructions, or online at [www.bush-support.com](http://www.bush-support.com) If you still require further assistance, call one of our experts on 0345 604 0105.

# Using your PORTABLE DVD PLAYER

Let's get started

## TV Type

Selecting the colour system that corresponds to your TV when AV outputs. This DVD Player is compatible with both NTSC and PAL.

**PAL** - Select this if the connected TV is PAL system. It will change the video signal of a NTSC disc and output in PAL format.

**NTSC** - Select this if the connected TV is NTSC system. It will change the video signal of a PAL disc and output in NTSC format.

**Auto**: Change the video signal output automatic according to the playing disk format.

**Audio**: Selects a language for audio (if available).

**Subtitle**: Selects a language for subtitle (if available).

**Disc Menu**: Selects a language for disc menu (if available).

## Parental

Some DVDs may have a parental level assigned to the complete disc or to certain scenes on the disc. This feature lets you set a playback limitation level. The rating levels are from 1 to 8 and are country dependent. You can prohibit the playing of certain discs that are not suitable for your children or have certain discs played with alternative scenes.

**Default**: Back to the factory setting.

## Password Setup Page

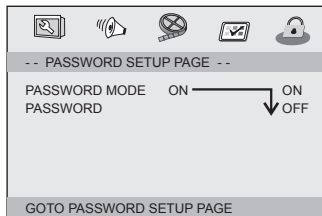

**Password mode**: Set password mode on/off. If set to off, change parental level will not check password.

## Password Setup Page

**Password**: select the menu password change page.



If you require any technical guidance or find that your product is not operating as intended, a simple solution can often be found in the **Troubleshooting**

# Using your PORTABLE DVD PLAYER

Let's get started

OLD PASSWORD: Enter the OLD password, (Factory setting is 1369), and the cursor will jump automatically to NEW PASSWORD

NEW PASSWORD: Enter the NEW password. Enter 4 digits from the remote control unit numeric buttons, and the cursor will automatically jump to CONFIRM PASSWORD.

CONFIRM PASSWORD: Confirm the NEW password by entering it again. If the confirmation is incorrect, the cursor will stay in this column. After entering, the correct new password again, the cursor will jump automatically to OK.

OK: When cursor is on this button, press ENTER key to confirm setting.



Note: If the password has been changed, the parental and disc lock code will also be changed. The default need more space between the letters and "(1369)" should be bold always active even the password has been changed.





# Other information 4



# Other information

Helpful technical information

## Parameters and specifications

Electronical parameters

Item		Standard requirement
Power requirements		: AC 100-240 V , 50/60 Hz
Power consumption		: <10W
Operating humidity		: 5 % to 90 %
Output	VIDEO OUT	:1 Vp-p (75Ω )
	AUDIO OUT	:1.2 Vrms (1 KHz, 0 dB)

System

Laser	:Semiconductor laser, wavelength 650 nm
Signal system	: NTSC / PAL
Frequency response	: 20Hz to 20 kHz(1dB)
Signal-to-noise ratio	:More than 80 dB (ANALOG OUT connectors only)
Dynamic range	:More than 85 dB (DVD/CD)

Note: Design and specifications are subject to change prior notice.

### Battery Parameters

Battery Specifications:

Output: 7.4V

Charge / Discharge Time:

Standard charge time: 3h ~ 4h

Storage and work circumstances:

1. Storage circumstances	Temperature	Humidity
6 months	-20°C ~ +45°C	65±20%
1 week	-20°C ~ +65°C	65±20%

2.Work circumstances	Temperature	Humidity
Standard charge	0°C ~ +45°C	65±20%
Standard discharge	-20°C ~ +65°C	65±20%

If you require any technical guidance or find that your product is not operating as intended, a simple solution can often be found in the **Troubleshooting**





# Product support 5



# Product support

Help is always at hand

## Troubleshooting

Question	Answer
The DVD does not switch on.	<ul style="list-style-type: none"><li>• Make sure the DVD player is charged or plugged in.</li><li>• Ensure the ON / OFF switch on the DVD player is in the ON position.</li></ul>
The DVD player switches off spontaneously.	<ul style="list-style-type: none"><li>• The DVD player will switch off automatically without any user intervention if auto standby is switched on. Press the any button on the remote control or DVD player to turn the DVD player back on.</li><li>• The DVD player is unable to read the disc.</li><li>• Ensure the DVD has been inserted with the label side facing upwards.</li><li>• Check the DVD is suitable for playing on the DVD player.</li><li>• Check that the DVD's regional code matches the regional code of the DVD player, region 2.</li><li>• The disc maybe dirty, clean the disc following the information</li></ul>
There is no sound or the sound is of poor quality.	<ul style="list-style-type: none"><li>• Make sure the sound is turned up.</li><li>• Make sure the MUTE function is not on.</li><li>• Ensure the headphones are fully inserted in the socket on the DVD player.</li></ul>
The remote control does not work or only works intermittently.	<ul style="list-style-type: none"><li>• Check the batteries are correctly inserted or change them for new ones.</li><li>• Check that nothing is blocking the signal from the remote control and the remote sensor on the DVD player.</li><li>• Check you are using the correct remote control for the DVD player.</li></ul>
The subtitles do not appear.	<ul style="list-style-type: none"><li>• Check that the DVD provides subtitles.</li></ul>
The disc menu language is not correct.	<ul style="list-style-type: none"><li>• The DVD does not support the language you have selected.</li></ul>

If you require any technical guidance or find that your product is not operating as intended, a simple solution can often be found in the **Troubleshooting**

# Product support

Help is always at hand

## Help and assistance

If you require any technical guidance or find that your Bush Portable DVD Player is not operating as intended, a simple solution can often be found in the **Troubleshooting** section of these instructions or online at [www.bush-support.com](http://www.bush-support.com)

If you still require further assistance, call one of our experts on **0345 604 0105** . To help give us give you a fast and efficient service please have the following information ready:

Model Ref.

You can find these on the rating plate - a small information panel (usually a sticker or metal plate) on the rear of your product.

Serial number

Date of purchase

This will be shown on your receipt

Local call rates applies\*

Lines open 8am-7pm Monday to Saturday and 10am-4pm Sunday.

\*Calls to Bush enquiry lines may attract a charge and set up fee from residential lines depending on your call plan/tariff. Mobile and other providers costs may vary, see [www.bt.com/pricing](http://www.bt.com/pricing) for details.

For security and training purposes, telephone calls to and from customer service centres may be recorded and monitored. Calls from Republic of Ireland will attract international call charges.

section of these instructions, or online at [www.bush-support.com](http://www.bush-support.com) If you still require further assistance, call one of our experts on **0345 604 0105**.

# Product support

Help is always at hand

## Disposal



This marking indicates that this product should not be disposed with other household wastes throughout the EU. To prevent possible harm to the environment or human health from uncontrolled waste disposal, recycle it responsibly to promote the sustainable reuse of material resources. To return your used device, please use the return and collection systems or contact the retailer where the product was purchased. They can take this product for environmental safe recycling.



This appliance complies with the following EC directives:  
2014/30/EU Low voltage directive  
2014/35/EU EMC directive

If you require any technical guidance or find that your product is not operating as intended, a simple solution can often be found in the **Troubleshooting**



# Product support

Help is always at hand



## Call us now and activate your 12 month guarantee

Thank you for choosing Bush. Your new product is guaranteed against faults and breakdowns for 12 months. Don't forget to register it with us today so we can provide you with our best possible after-sales service and useful updates.

[www.bushregistration.co.uk](http://www.bushregistration.co.uk)

FREEPHONE\*

**0800 597 8548**

Lines are open 8am - 8pm, 365 days a year. \*Calls may be recorded and monitored.

## Your Bush Guarantee

This product is guaranteed for twelve months from the date of original purchase. Any defect that arises due to faulty materials or workmanship will be repaired free of charge (or if applicable the product will be replaced or the purchase price refunded) where possible during this period by the dealer from who your purchased the unit.

### The guarantee is subject to the following provisions:

- The guarantee does not cover accidental damage, misuse, cabinet parts, knobs or consumable items.
- The product must be correctly installed and operated in accordance with the instructions contained in the manual.
- It must be used solely for domestic purposes. The guarantee will be rendered invalid if the product is re-sold or has been damaged by inexpert repair.
- Specifications are subject to change without notice.
- Bush disclaim any liability for loss or damage arising from the breakdown of the product.
- This guarantee is in addition to and does not diminish your statutory or legal rights.

## Important Data Protection Information

If you provide us with information about another person, you confirm that they have appointed you to act for them, to consent to the processing of their personal data including sensitive personal data and that you have informed them of our identity and the purposes (as set out in the Important Data Privacy notice displayed overleaf) for which their personal data will be processed.

You are entitled to ask for a copy of the information we hold about you (for which we may charge a small fee) and to have any inaccuracies in your information corrected.

For quality control and training purposes, we may monitor or record your communications with us.

If your personal details change, if you change your mind about any of your marketing preferences or if you have any queries about how we use your information, please let us know by contacting our Data Protection **Officer, Domestic & General, Leicester House** 17 Leicester Street, Bedworth, Warwickshire CV12 8JP.

Guarantor: Argos Limited - 489 - 499 Avebury Blvd. - Milton Keynes - MK9 2NW

section of these instructions, or online at [www.bush-support.com](http://www.bush-support.com) If you still require further assistance, call one of our experts on **0345 604 0105**.





# BUSH

Contact:

[www.bush-support.com](http://www.bush-support.com)

Helpline: 0345 604 0105

