

# ALBA

## 28" LED TV Player Instruction manual

LE-28GA06-B3



You'll soon be up and running

Looking forward to your new Alba LED TV? Great.

Then let's get you started.

Just follow this simple step-by-step guide and you'll be good to go.

## Help and Guidance

We're here to help you get the most from your TV. Should you require any guidance, a simple solution can often be found online at:

[www.argos-support.co.uk](http://www.argos-support.co.uk)

If you still require further assistance, call one of our experts on **0345 604 0105**.

If you require any technical guidance or find that your product is not operating as intended, a simple solution can often be found in the **Troubleshooting** section of these instructions.

**ALBA**

# Contents

<b>1 Safety information</b>		
Safety information	6	
<b>2 Getting Started</b>		
TV-Features	10	
Accessories included	10	
Installing/Removing the Base Stand	11	
Viewing remote control - TV	12	
TV - Control buttons (Right side)	15	
Aerial connection	15	
Power connection	15	
Remote control - Inserting batteries	16	
Switching the TV On and Off	16	
Operation using TV control buttons	17	
To Program Your SKY Remote For Your TV	17	
<b>3 Connections</b>		
Connections	20	
First time setup	21	
<b>4 How to use your TV</b>		
Selecting Input Source	26	
Using The Electronic Programme Guide(EPG)	26	
Viewing Teletext	28	
Using The Time Shift Function	29	
Recording DTV Programmes	30	
Watching Recorded Programmes	31	
<b>5 TV systems management</b>		
Picture Menu	36	
Sound Menu	37	
Channel Menu	38	
Lock Menu	42	
Time Menu	43	
Settings Menu	45	
<b>6 Entertainment Features</b>		
Using The USB Features	50	
Viewing Movies	51	
Listening to Music	52	
Viewing Photos	53	
Viewing Files	54	
<b>7 Other information</b>		
Specifications	58	
Digital reception	58	
Plug replacement - UK and Ireland only	59	
Energy label	59	
<b>8 Product Support</b>		
Trouble shooting	62	
Definition of terms	63	
Supported file formats	64	
Disposal information	64	
Disposal	66	
Guarantee	67	



# Safety information

1





## Safety information

**Important** - Please read these instructions fully before installing or operating

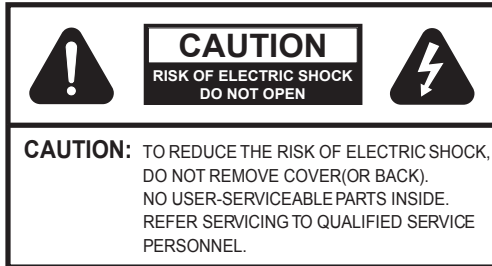

The lightning flash with arrowhead symbol, within an equilateral triangle, is intended to alert the user to the presence of uninsulated "dangerous voltage" within the product's enclosure that may be of sufficient magnitude to constitute a risk of electric shock of persons.



The exclamation point within an equilateral triangle is intended to alert the user to the presence of important operating and maintenance (servicing) instructions in the literature accompanying the appliance.

### Power source

- The TV should be operated only from a 100-240V AC, 50 Hz outlet.
- **Warning:** Do not leave your TV in standby or operating mode when you leave your house.

### Positioning the TV

- For ventilation, please leave a clear space of at least 10cm all around the TV.

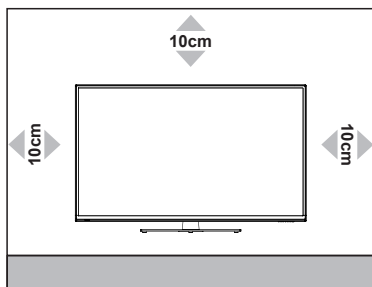

- **Do not** block the ventilation openings.
- Do not place the TV on sloping or unstable surfaces, the TV may tip over.
- To prevent damage to the TV, do not place any objects on top of the TV.
- Only use the TV in moderate climates.

If you require any technical guidance or find that your product is not operating as intended, a simple solution can often be found in the **Troubleshooting** section of these instructions.

### Power cord and plug

- The power cord plug should be easily accessible. In case of storms and lightning, when going on holiday, or when the TV is not used for a long period of time disconnect the power cord from the mains power socket.
- **Do not** place the TV, furniture, etc. on the power cord or pinch the cord.
- Handle the power cord by the plug, do not unplug the TV by pulling the power cord.
- Never touch the power cord/plug with wet hands as this could cause a short circuit or electric shock.
- Never make a knot in the power cord or tie it with other cords.
- Power cords should be placed in such away that they are not likely to be stepped on or driven over.
- A damaged power cord/plug can cause fire or give you an electric shock. When damaged it must be replaced, this should only be done by qualified personnel.

### Moisture and Water

- **Do not** use this TV in a humid or damp place (avoid bathrooms, the sink in the kitchen, and near the washing machine).
- **Do not** expose this TV to rain or water, as this may be dangerous.
- **Do not** place objects filled with liquids, such as flower vases, on top of the TV. Avoid from dripping or splashing.
- If any solid object or liquid falls into the cabinet, unplug the TV and have it checked by qualified personnel before operating it any further.

### Ventilation

- The slots and openings on the TV set are intended for ventilation and to ensure reliable operation.
- To prevent overheating, these openings must not be blocked or covered in anyway.



## Safety information

**Important** - Please read these instructions fully before installing or operating

### Headphone volume

- Excessive sound pressure from earphones and headphones can cause hearing loss, please take care.

### Headphone volume

To prevent injury, this TV must be securely attached to the wall in accordance with the installation instructions (if the option is available).

### LCD Screen

- The LCD screen is a very high technology product with about a million thin film transistors, giving you fine picture details. Occasionally, a few non-active pixels may appear on the screen as a fixed blue, green or red point. Please note that this does not affect the performance of your product.
- Take care not to scratch the screen with fingernails or other hard objects.

### Cleaning

- Before cleaning, unplug the TV from the wall socket.
- Do not** use liquid or aerosol cleaners. Only use a soft, dry cloth.

### Batteries

- Warning:** Incorrect installation of batteries may cause battery leakage and corrosion, resulting in damage to the remote control.
- Do not** mix old and new batteries, or batteries of different types.
- Do not** dispose of batteries in a fire.
- Do not** dispose of batteries with normal household waste, take to a local recycling centre.



### Replacement parts

When replacement parts are required, make sure that the service technician has used replacement parts, which are specified by the manufacturer or have the same specifications as the original one. Unauthorised substitutions may result in fire, electrical shock or other hazards.

### Servicing

**Warning:** Risk of exposure to radiation from class 1/class 3b visible and invisible laser beams. **Do not** open the TV and stare directly into beam.

**Warning:** Risk of electric shock, do not attempt to repair, service or modify this TV yourself. Contact the manufacturer, their approved service agent or the **Customer Helpline: 0345 604 0105**.

- This equipment is a Class II or double insulated electrical appliance. It has been designed in such a way that it does not require a safety connection to electrical earth.
- Warning:** To prevent the spread of fire, keep candles or other open flames away from this product at all times.





# Getting Started 2



# Getting Started

You'll be up and running in no time

## TV - Features

- Remote controlled colour LCD TV.
- Fully integrated digital TV (DVB-T).
- HDMI connectors for digital video and audio. This connection is also designed to accept high definition signals.
- USB input.
- 100 programmes from VHF, UHF (analogue).
- 400 programmes for digital mode (DTV).
- OSD menu system.
- Scart socket for external devices (such as video, video games, audio set, etc.).
- Stereo sound system.
- Teletext, fastext, TOP text.
- Headphone connection.
- Automatic programming system.
- Forward or backward manual tuning.
- Sleep timer.
- Child lock.
- AVL (Automatic Volume Limiting).
- PLL (Frequency Search).
- PC input.
- Plug & Play for Windows 98, ME, 2000, XP, Vista.

## Accessories included

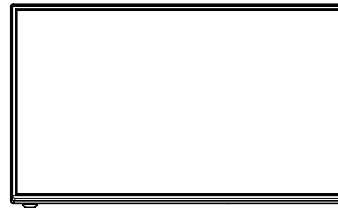

TV



Remote Control  
Batteries: 2 x AAA



MINI YPBPR Cable



MINI AV Cable



Stand Base

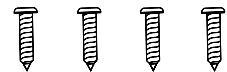

Screws (4PCS)

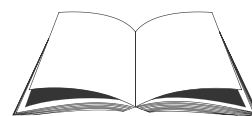

Instruction Book

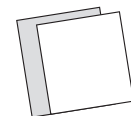

Quick start guide

If you require any technical guidance or find that your product is not operating as intended, a simple solution can often be found in the **Troubleshooting** section of these instructions.

# Getting Started

You'll be up and running in no time

## Installing / Removing the Base Stand

### Base Stand Assembly Instruction

1. Place the TV with the display side down on a flat surface. Use a cloth to protect. Locate the bottom at the stand.
2. Fix the bottom with turning the screw (4PCS) tightly on the stand.

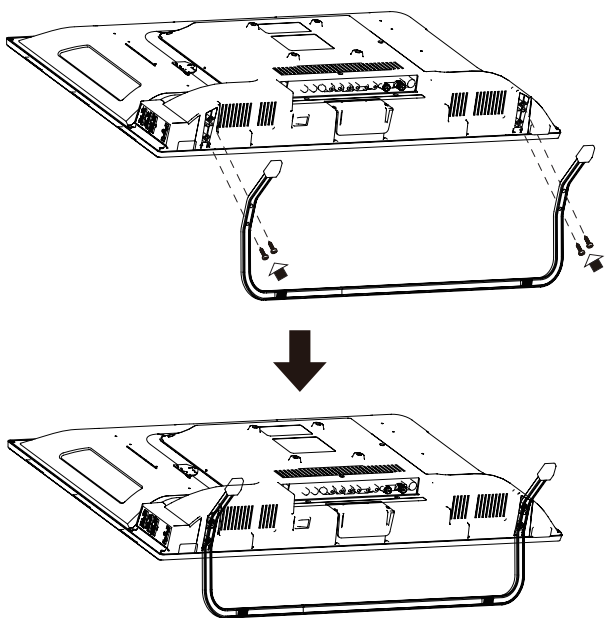

### INSTALLATION NOTES

This TV can be connected to an AC 100-240 Volts, 50/60 Hz power supply. Never connect straight to a DC power supply.

Locate the TV in a room where light does not strike the screen directly. Total darkness or a reflection on the screen can cause eyestrain. Soft and indirect lighting is recommended for comfortable viewing.

Allow enough space between the TV and the wall to permit ventilation.

Avoid excessively warm locations to prevent possible damage to the cabinet or premature component failure.

### WALL MOUNTING INSTALLATION GUIDELINES

This television can be wall mounted as follows:

1. Place the LED LCD Television onto a solid surface. Please place some soft material over the front of the screen to protect it from any damage.
2. Remove the stand base by undoing the 4 screws (retain the stand base for future use).

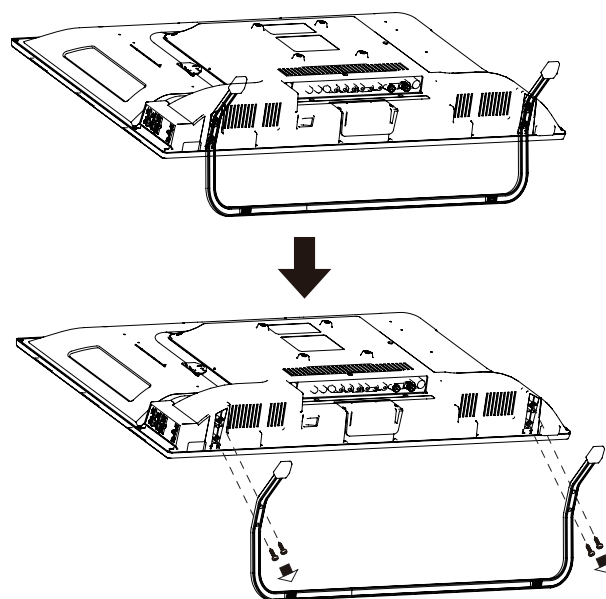

3. To prevent injury, this TV must be securely attached to the wall in accordance with the bracket installation instructions. Please note VESA size is 100 x 100mm. 4x M6\*12 bolts are required to secure the bracket to the VESA standard holes on the back of the television.

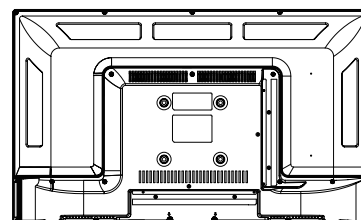

100 x 100mm VESA mount

# Getting Started

You'll be up and running in no time

## Viewing remote control - TV

1. **Power**  
Switch the TV between on and standby mode.
2. **MUTE**  
Mutes and restores your TV sound.
3. **0-9 Number Button**  
Press to select a programme. (ATV / DTV mode)
4. **CH.LIST**  
Display channel list. (ATV / DTV mode)
5. **Return**  
Return to the previous viewing channel. (ATV/ DTV mode)
6. **P.MODE**  
Select picture mode: Dynamic / Standard /Mild / Personal.
7. **S.MODE**  
Select sound mode: Standard / Music / Movie/ Personal.
8. **TV.RD**  
Select TV program or Radio program. (DTV mode).
9. **LANG**  
Select DTV audio language. (DTV mode)
10. **SOURCE**  
Select among the different input signal sources: Digital TV/Analogue TV/Composite/AV/SCART/Component/ Ypbpr/HDMI 1/HDMI 2/HDMI 3/PC.
11. **DISPLAY**  
Display the present screen information such as the current channel and the input source.
12. **CH+/-**  
Select a channel.
13. **VOL+/-**  
Adjust the volume.
14. **NICAM**  
Switch between different audio channels (only applicable when the TV programme has this feature).

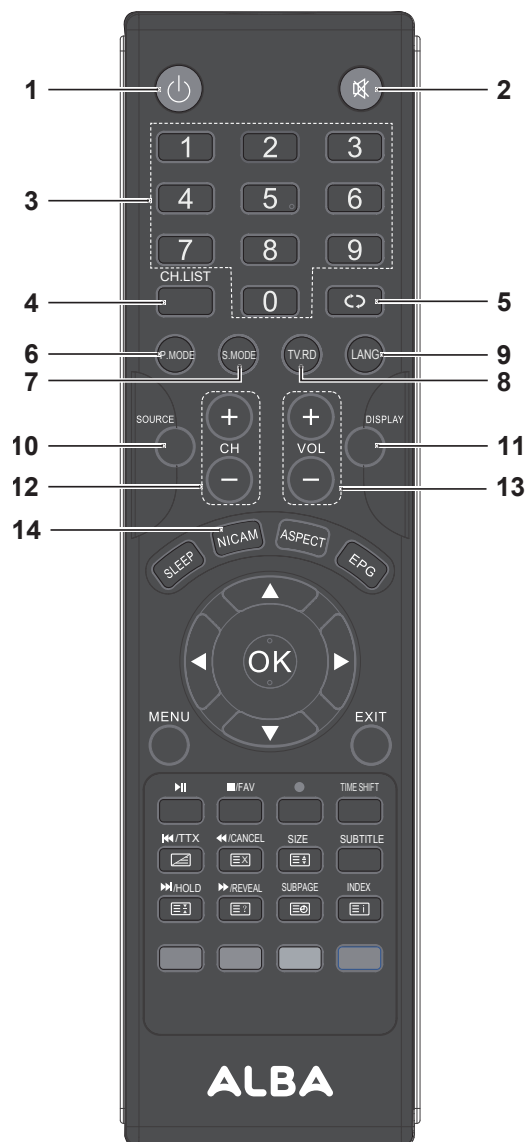

If you require any technical guidance or find that your product is not operating as intended, a simple solution can often be found in the **Troubleshooting** section of these instructions.

# Getting Started

You'll be up and running in no time

## Viewing remote control - TV

### 15. ASPECT

Select from the following mode settings: 16:9 / Zoom1 / Zoom2 / Auto / 4:3.

### 16. SLEEP

Set the TV sleep timer.

### 17. EPG

Display the EPG (Electronic Program Guide).(DTVmode)

### 18. ◀▶▲▼

Allows you to navigate the OSD menus and adjust the system settings to your preference.

#### OK

- Confirm the selection in the OSD menus.
- Display a list of channels saved in the TV tuner memory.

### 19. MENU

Display the OSD (On Screen Display) menu.

### 20. EXIT

Exit the OSD (On Screen Display) menu.

### 21. ■

Press once to stop. (USB mode)

#### FAV

Display the Favourite Channel list. ( ATV / DTV mode)

### 22. ●

Record the current programme. (DTV mode)

### 23. ▶||

- To start the timeshift playback. (DTV mode)
- To start playback or pause. (USB mode)

### 24. TIMESHIFT

Start the time-shift function. (DTV mode)

### 25. ☒ TTX

Turn on and off the Teletext function. (ATV /DTV mode)

#### ◀◀

To skip to the beginning of the previous chapter / track / photo. (USB mode)

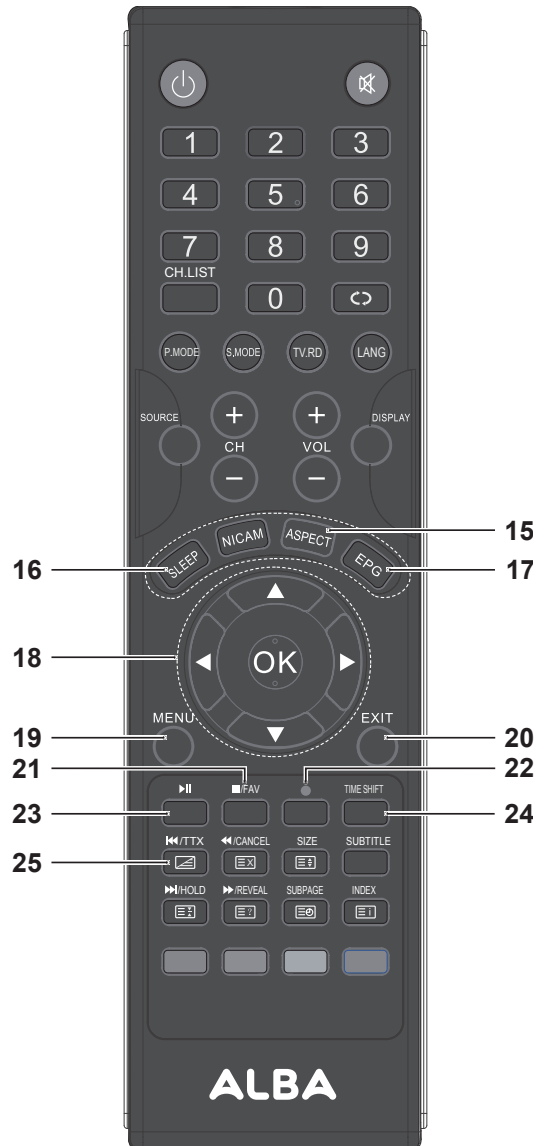

# Getting Started

You'll be up and running in no time

## Viewing remote control - TV

### 26. SUBTITLE

Display the subtitle which is broadcast with the program. (DTV mode)

### 27. CANCEL

To exit the teletext mode. (ATV / DTV mode)



To reverse playback rapidly. (USB mode)

### 28. SIZE

To enlarge the picture on the TV in teletext. (ATV / DTV mode)

### 29. HOLD

Freezes a multi-page passage on screen in teletext. (ATV / DTV mode)



To skip to the beginning of the next chapter /track / photo. (USB mode)

### 30. INDEX

To select the page number of the index from teletext. (ATV / DTV mode)

### 31. REVEAL

Reveals hidden information such as the answer to a quiz in teletext. (ATV / DTV mode).



To advance playback rapidly. (USB mode)

### 32. SUBPAGE

Displays the subpage on the teletext screen.(ATV / DTV mode)

### 33. Coloured buttons

Accesses the TELETEXT items or channel edit when using Digital / Freeview TV Channels. (ATV / DTV mode)



If you require any technical guidance or find that your product is not operating as intended, a simple solution can often be found in the **Troubleshooting** section of these instructions.

# Getting Started

You'll be up and running in no time

## TV - Control buttons (Right side)

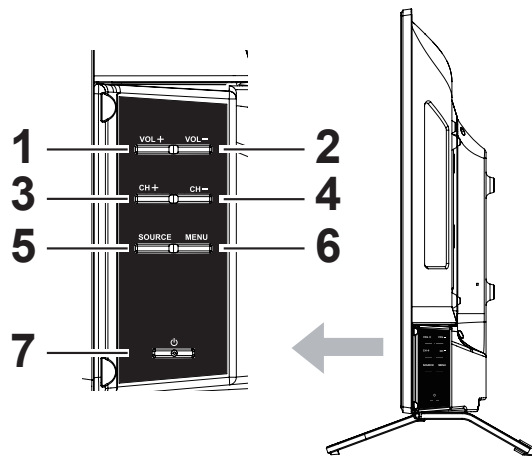

### 1. VOL+ button

Increases the volume.

### 2. VOL- button

Decreases the volume.

### 3. CH+ button

Moves up a channel.

### 4. CH- button

Moves down a channel.

### 5. SOURCE button

Press to select among different input signal sources.

### 6. MENU button

Displays the OSD (on screen display) menu.

### 7. (⏻) button

Turns the TV on when in standby mode or turns the TV off into standby mode.

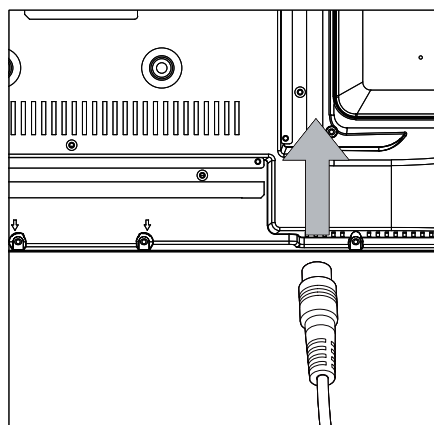

## Aerial connection

Connect the "aerial" or "cable TV" plug to AERIAL INPUT (ANT.) socket located on the back of the TV .

## Power connection

**Please note:** After unpacking, allow the TV to reach ambient room temperature before connecting the TV to the mains power socket.  
Connect the power cord plug to the mains power socket.

or online at [www.argos-support.co.uk](http://www.argos-support.co.uk) If you still require further assistance, call one of our experts on 0345 604 0105.

# Getting Started

You'll be up and running in no time

## Remote control - Inserting batteries

Remove the battery cover on the back of the remote control, gently push down and pull backwards at the same time as shown.

Insert two AAA or equivalent type batteries. Ensure the batteries are inserted the correct way and replace the battery cover.

**Note:** When the remote control is not going to be used for long periods of time, the batteries should be removed. Otherwise the remote control may be damaged, caused by battery leakage and corrosion.

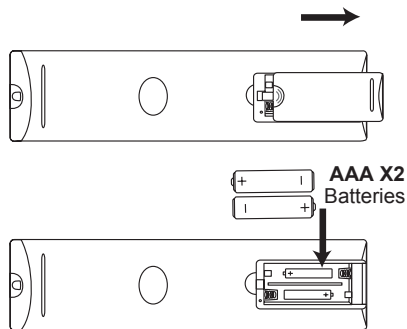

## Switching the TV On and Off

### Switching the TV On

With power cord plugged connected to the mains power socket and TV in 'Standby' mode.

To switch the TV on from standby mode, either:

**a: The Remote control;** Press the "⏻" button.

**b: The TV;** Press the "⏻" button at the right of the TV.

### Switching the TV Off

Either press the "⏻" button on the remote control or press the "⏻" button at the right of the TV, the TV will then switch to standby mode.

If you require any technical guidance or find that your product is not operating as intended, a simple solution can often be found in the **Troubleshooting** section of these instructions.



# Getting Started

You'll be up and running in no time

## Operation using TV control buttons

The **VOL+/VOL-** buttons will function as volume up/down as default. Even if you set other functions for these buttons, the **VOL+/VOL-** buttons will return to volume control after a short while.

### Volume Setting

Press **VOL+/VOL-** buttons to increase or decrease volume.

### Channel Selection

Press **CH+/CH-** buttons to select the next or previous channel.

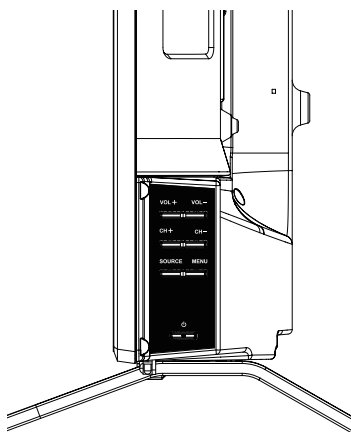

The remote control is designed to control all the functions of the model you selected.

### Volume Setting

Press **VOL+** button to increase the volume. Press **VOL-** button to decrease the volume. A volume level scale (slider) will be displayed on the screen.

### Channel Selection (Previous or Next Channel)

Press **CH-** button to select the previous channel.  
Press **CH+** button to select the next channel.

### Channel Selection (Direct Access)

Press number buttons on the remote control to select programmes between 0 and 9. The TV will switch to the selected channel.



## To Program Your SKY Remote For Your TV

Set up your Sky Q remote to control your TV

To set up your Sky Q remote to control the volume, power and input source on your new TV press Menu, select Settings, then Setup, then Remote control. Select your Sky Q remote and follow the on screen instructions.

1. Make sure your SKY box is connected to your TV
2. Turn your TV and SKY box on
3. Press TV on your SKY remote control handset
4. Hold down SELECT and the RED button together for about two seconds, until the red light on the SKY remote blinks twice.
5. Key in 3992 on your SKY remote. The light on the SKY remote should blink twice
6. Press the STANDBY button on your SKY remote control. Your TV should now switch off.
7. Press SELECT again. The light on your SKY remote control should now blink twice

You should now be able to control some basic functions on your TV from your SKY remote control (e.g. volume up/down, programme up/down).

\*If this number does not work, please go to SKY website to find the alternative number to operate the TV.

























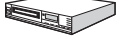



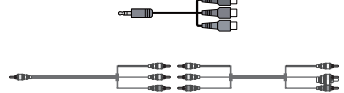

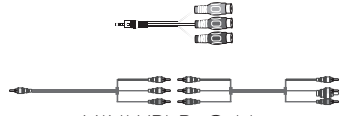
# Connections 3

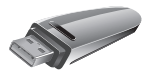

# Connections

You'll be up and running in no time

## Connections

Connector	Type	Cables	Device
LAN 	Ethernet Connection (Bottom)	 LAN / Ethernet Cable	Service Use Only
VGA 	VGA Connection (Bottom)		
PC AUDIO 	PC Audio Connection (Bottom)	 PC Audio Cable	
SCART 	Scart Connection (Bottom)		
HDMI 	HDMI Connection (Bottom/Side)		
OPTICAL 	OPTICAL Connection (Side)		
MINI AV 	MINI AV Connection (Side)	 MINI AV Cable	
MINI YPBPR 	MINI YPBPr Connection (Side)	 MINI YPBPr Cable	
CI 	CI Connection (Side)		
USB 	USB Connection (Side)		
HDMI 2	HDMI 2(ARC)		
HEADPHONE 	Headphone Connection (Side)		

**NOTE: When connecting a device via the YPbPr or Side AV input, you must use the connection cables to enable connection.**

See the illustrations on the left side, you can use HDMI / OPTICAL/ MINI AV /MINI YPBPR/ CI/USB/ Headphone Socket ports. / On the left side, you can use VAG/PC AUDIO/SCART/HDMI ports. / You can connect to HD video sources using the HDMI port. / You can connect your TV to other devices such as a camera, camcorder or games console with MINI AV port. | Your TV can be connected to high definition sources using the component YPbPr cable. / You can connect your TV to devices with a SCART output such as a set top box or DVD player. | When using the wall mounting kit (available from third party in the market, if not supplied), we recommend that you plug all your cables into the back of the TV before mounting on the wall. | Insert or remove the CI module only when the TV is SWITCHED OFF. You should refer to the module instruction manual for details of the settings. | The/Each USB input of your TV supports devices up to 500mA. Connecting devices that have current value above 500mA may damage your TV. | By connecting an HDMI cable to your TV, you have to use only a shielded HDMI cable to guarantee a sufficient immunity against parasitic frequency radiation.

If you want to connect a device to the TV, make sure that both the TV and the device are turned off before making any connection. After the connection is done, you can turn on the units and use them.

Note: ARC is supported only via the HDMI2 input.

If you require any technical guidance or find that your product is not operating as intended, a simple solution can often be found in the **Troubleshooting** section of these instructions.





# Connections

You'll be up and running in no time

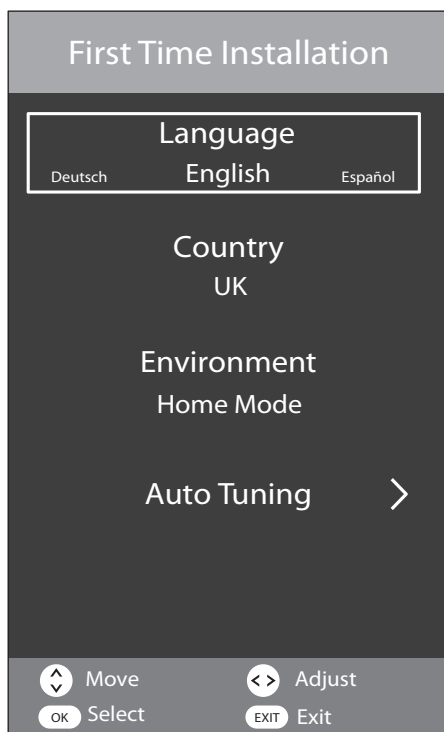
## First time setup

1. Connect one end of an RF coaxial cable (not supplied) to the aerial socket in your wall. Connect the other end of the cable to the RF (75)socket in the right side connection panel on the back of the TV.
2. Attach all other devices to the TV following the advice given in the instructions supplied with them.
3. Slot the plug on the TV's mains cable into a wall socket and turn the power on if required.
4. In standby mode, press the  button on the right of the TV or on the remote control to turn the TV on. The red LED indicator on the front of the TV will turn blue, then you will go to the First Time Installation menu.



5. Language is preset to English.
6. Press  buttons to select country and use  buttons to set the desired country.
7. Press  buttons to select Environment and use  buttons to select between Home Mode and Store Mode. If you select to change to Store Mode, a warning screen will appear asking if you do, select YES or NO to continue.
8. Once you have completed all of the preliminary settings, press  buttons to select Auto Tuning and then press **OK** button to start channel tuning.

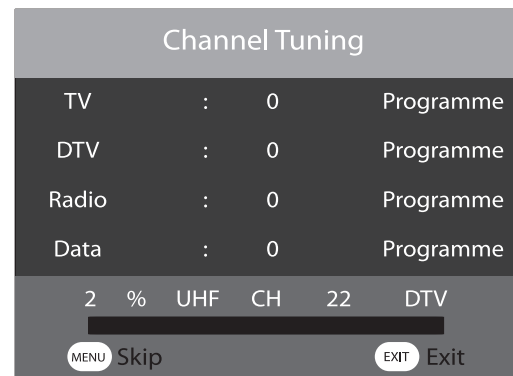

9. Once the tuning process has been completed the Country menu will be shown, press the **OK** button to confirm.



# Connections

## Bringing it all together

10. Next the Primary Region menu will open, press **OK** to confirm.

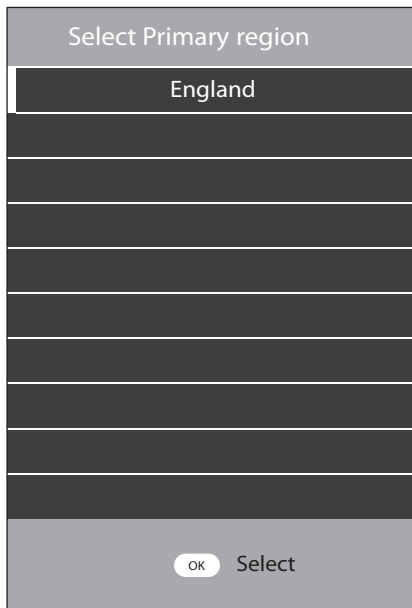

11. Next the Secondary Region menu will open, use the **▲▼** buttons to select your secondary region then press the **OK** button.

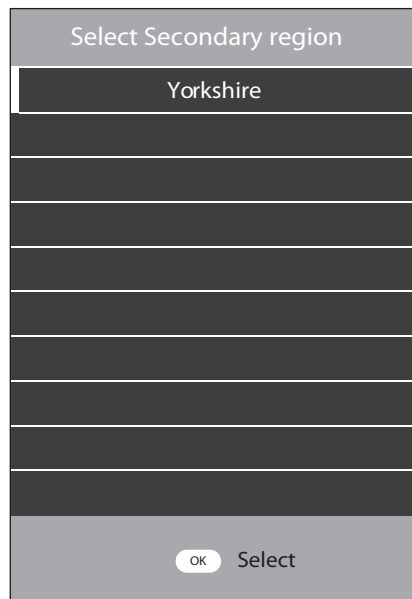

12. After pressing the **OK** button the Channel Tuning menu will be displayed again for a few minutes as your TV saves the settings.

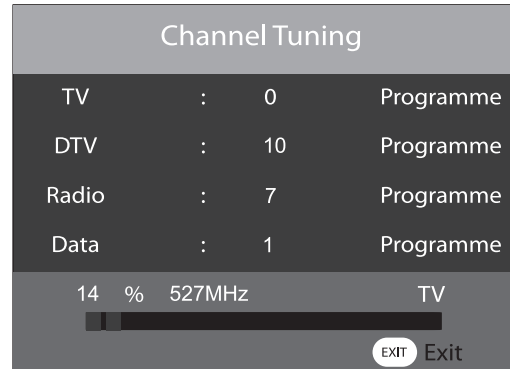

13. After settings have been saved the TV will automatically tune to the first available channel. Your TV is now ready for use.



If you require any technical guidance or find that your product is not operating as intended, a simple solution can often be found in the **Troubleshooting** section of these instructions.







# How to use your TV

4



# How to use your TV

Let's get started

## SELECTING INPUT SOURCE

You can connect multiple devices to your TV to improve your watching and listening pleasure.

1. Press the **SOURCE** button on the TV or on the remote control to display the source menu.

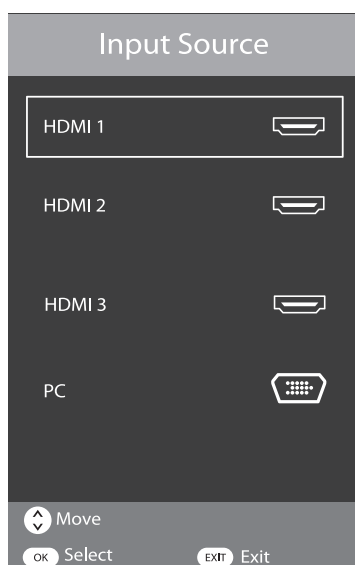

2. Use the **▲▼** buttons to select the source you wish to watch or listen to and then press **OK** button to confirm.

**Note:** Not all sources will be displayed when the menu is open. You will need to use the **▲▼** buttons to scroll through the list to view all of the sources.

## USING THE ELECTRONIC PROGRAMME GUIDE (EPG)

### Digital TV (DTV) channels only

Your TV has an Electronic Programme Guide (EPG) to help you navigate through all your possible viewing options. The EPG supplies information such as programme listings, start and end times for all available. In addition, detailed information about the programme is often available in EPG (the availability and amount of programme information will vary, depending on the particular broadcast). This function can only be used when the information is broadcast by the broadcasting companies. The EPG displays the programme details for the next 7 days.

1. Press the **EPG** button on the remote control to display the Electronic Programme Guide window.



2. Use the **▲▼** buttons to select the station you wish to watch or listen to, then press the **OK** button to tune to that station.
3. Press the **▶** button to enter the programme listings to look through all of the programmes available over the next 7 days.

If you require any technical guidance or find that your product is not operating as intended, a simple solution can often be found in the **Troubleshooting** section of these instructions.

# How to use your TV

## Let's get started

At the bottom of the window there are 4 additional feature buttons which can be accessed by using the coloured buttons on the remote control.

### RED button: Recorder

Press this button to record programmes to a USB drive attached to the USB port on your TV.

**Note:** Select the desired programme you want to record and press RED button once/twice/triple, **R/D/W** will display on the left top of the selected programme.

**R**: Mode Once

**D**: Mode Everyday

**W**: Mode Every Week

### GREEN button: Prev Day

Press the green button to scroll through the previous 7 days of programmes.

Note: This only works if the broadcaster supports this function.

### YELLOW button: Next Day

Press the yellow button to scroll through the next 7 days of programmes.

Note: This only works if the broadcaster supports this function.

### BLUE button: Remind

Press the blue button to set the reminder to programmes you want.

**Note:** Select the desired programme you want to set reminder and press BLUE button once/twice/triple, **R/D/W** will show on the left top of the selected programme.

**R**: Mode Once

**D**: Mode Everyday

**W**: Mode Every Week

# How to use your TV

Let's get started

## VIEWING TELETEXT

Digital TV (DTV) channels only

**IMPORTANT:** Before viewing Teletext, you need to turn the Subtitle function off if it is switched on.

**Note:** Before turning Teletext on, check that the TV channel you are watching transmits Teletext. If it does not, **NO Teletext** will be shown on the screen.

1. Press the **◀◀**/TTX button on the remote control to display the Teletext menu.



2. Follow the information on the Teletext page to access the page you want to view. You can also use the **0** to **9** buttons on the remote control to enter the page number you want to view.
3. You can also press the **RED** button on the remote control instead of the **◀◀**/TTX button when the red Teletext logo is shown on the TV screen.
4. Press the **◀◀**/TTX button again to exit the Teletext menu.

## How to select a page of text

1. Find the number of the page you wish to view and enter it in the search panel using the **0** to **9** buttons on the remote control then press the **OK** button.
2. The page counter will search for your page you wish to view. When the page is found it will automatically be displayed.
3. To move to the next or previous page use the **▲▼** buttons on the remote control.
4. To return to the index page, enter **100** into the search panel using the **0** to **9** buttons on the remote control and press the **OK** button or press the **INDEX** button.

## How to use Fast Text

At the bottom of the Teletext page, there is a row of subject headings coloured in Red, Green, Yellow and Blue. To access these pages, simply press the correspondingly coloured buttons on the remote control.

If you require any technical guidance or find that your product is not operating as intended, a simple solution can often be found in the **Troubleshooting** section of these instructions.

# How to use your TV

Let's get started

## USING THE TIME SHIFT FUNCTION

### Digital (DTV) channels only

This function lets you quickly record the TV programme you are watching if you have to leave the room.

**IMPORTANT:** Please make sure a USB storage device has been attached to your TV before using the Time Shift function.

**IMPORTANT:** If the transfer rate of the attached USB storage device is too slow for the Time Shift function, a warning statement will be shown on the TV's screen. If this happens, please upgrade your USB storage device.

**IMPORTANT:** Time Shift mode may not work if the station's signal strength is too weak.

**NOTE:** Always stop the Time Shift function by pressing the **■** button before switching to another input source.

### Using the Time Shift function

1. To start Time Shift, press the **TIMESHIFT** button on the remote control to pause the programme you are watching. The Time Shift symbol will be displayed
2. When you wish to resume watching the programme, press the **▶||** button on the remote control to show the PVR Time Shift progress bar.
3. Use the **◀▶** buttons to select the button on the progress bar then press the **OK** button to start watching the programme. **▶** will be displayed in the top left of the TV screen showing you are watching a programme in Time Shift.
4. Press the **■** button to stop the Time Shift recording and return to the live TV broadcast.

**Alternatively:** You can press the **●** (red dot) button on the remote control to display the PVR Time Shift progress bar and then use the **◀▶** buttons to select **▶||** on the bar then press the **OK** button to start playback.

**Note:** There may be a slight delay with the video and the sound may be slightly out of sync for a few seconds when you start watching the recorded programme. This will soon stop and the programme will play correctly.

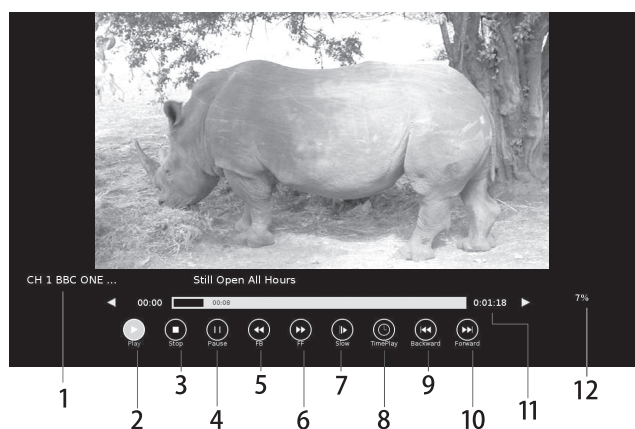

### The Time Shift progress bar

Use the **◀▶** buttons to navigate through the progress bar. Once you have selected the feature you wish to use press the **OK** button.

1. Shows the channel and name of the recorded programme.
2. **PLAY:** Select to play your recording.
3. **STOP:** Select to stop play back.
4. **PAUSE:** Select to pause the recording.
5. **FB:** Select to rewind your recording at x2 / x4 / x8 / x16 / x32 speed.
6. **FF:** Select to fast forward the recording at x1 / x2 / x4 / x8 / x16 / x32 speed.

# How to use your TV

## Let's get started

7. **Slow:** Select to view the recording in slow motion. Press the OK button multiple times choose between 2 / 4 / 8 / 16 / 32 playback speeds..
8. **Time Play:** Select to enter a time you wish to view the recording from using the 0 to 9 buttons on the remote control.
9. **Backward:** Select to move the recording backwards 30s of the recording.
10. **Forward:** Select to move the recording forwards 30s of the recording.
11. Shows the amount of playback time the recording has remaining.
12. Shows the amount of memory remaining on your USB drive.

## Using the remote control with

### Time Shift

You can use the buttons on the remote control to control playback in Time Shift.

- ▶|| Press to start and pause playback.
- ◀◀ Press repeatedly to rewind at x2 / x4 / x8 / x16 / x32 speed.
- ▶▶ Press repeatedly to fast forwards at x2 / x4 / x8 / x16 / x32 speed.

**Important:** To return to normal playback press the ▶|| button.

- ◀◀ Press to jump backwards approximately 30s of the recording time.
- ▶▶ Press to jump forwards approximately 30s of the recording time.
- Press to stop the Time Shift recording.

## RECORDING DTV PROGRAMMES

### Digital (DTV) channels only

You can record digital TV programs onto a USB drive using either direct recording by pressing the red dot button or using the program timer function.

**IMPORTANT:** You must have a USB storage device attached to your TV to use the recording function.

**IMPORTANT:** If the transfer rate of the attached USB storage device is too slow for the recording function, a warning statement will be shown on the TV's screen. If this happens, please upgrade your USB storage device.

**IMPORTANT:** Recording mode may not work if the stations signal strength is too weak.

### Instant recording

This option is used to record the Programme you are watching.

Press ● record button on the remote control to record the programme you are currently watching.

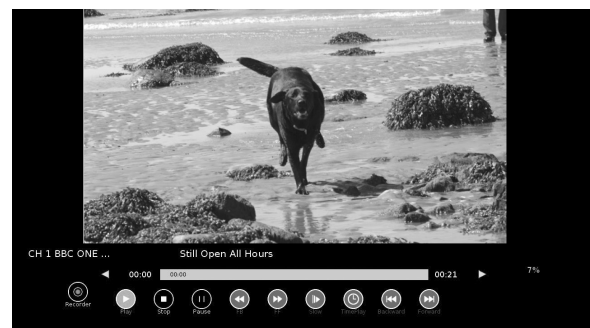

The recording progress bar will be displayed, press the EXIT button to close recording progress bar. The recording symbol in the top left of the screen will still be visible showing that the TV is still recording. If you want to view the recording progress bar again, press the ● button on the remote control.

# How to use your TV

Let's get started

## WATCHING RECORDED PROGRAMMES

You can play a recorded programme from the recorded programme list from the USB storage device.

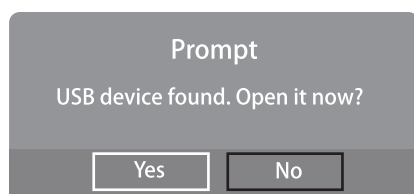

**Note:** When a USB storage device is inserted into the USB port in your TV, a message will pop up asking if you want to go directly to the USB MEDIA menu. Use the ◀▶ buttons to select either Yes or No and press the OK button to confirm.

1. Press the **MENU** button on the remote control or on the TV to display the main interface, then use ▲▼◀▶ buttons to select the **USB MEDIA** menu and press the **OK** button to confirm.

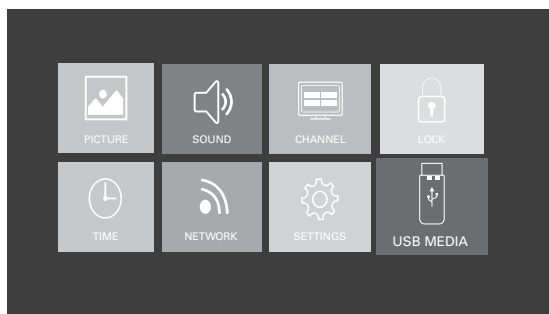

2. Press ◀▶ buttons to select **MOVIE** and press **OK** button to enter.

**Note:** if more than one USB device is connected to the TV, you need to firstly select one of them and then press OK to confirm, and select **MOVIE** to enter.

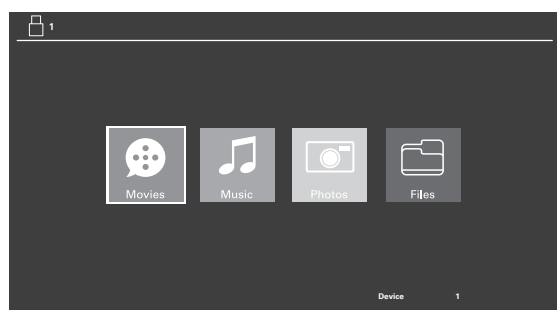

3. Use the ▲▼◀▶ buttons to select **\_MSTPVR** and press **OK** button to confirm.

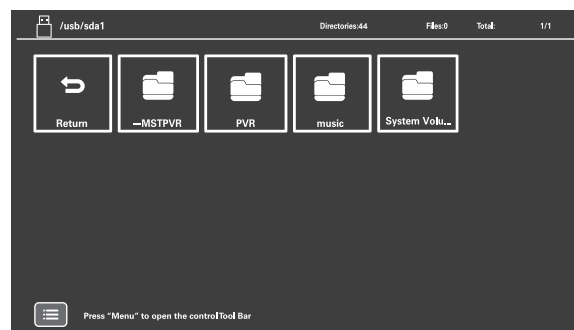

4. Use the ▲▼◀▶ buttons to select the recorded programme you wish to watch.

**Note:** When you highlight a film to watch, after a few seconds a thumbnail movie will appear on the screen.

5. If you have a lot of movies stored in the file you can press the **MENU** button to open the tool bar. This will help when looking through the files in your **\_MSTPVR** folder.
6. When you have found film you want to watch, press the **OK** or ▶|| button to play the recording in full screen mode.
7. Press the **DISPLAY** button to display the function bar at the bottom of the screen. Use the ◀▶ buttons to navigate through the functions then press the **OK** when you have highlighted the one you require. See over the page for a full list of the function bars list of functions.

or online at [www.argos-support.co.uk](http://www.argos-support.co.uk) If you still require further assistance, call one of our experts on 0345 604 0105.

# How to use your TV

Let's get started



## List of functions

**Previous:** Press to watch the previous programme in the playlist.

**Next:** Press to watch the next programme in the play list.

**Play/Pause:** Press to play/pause the programme.

**Stop:** Press to play back of the programme.

**FB:** Press repeatedly to rewind at x2 / x4 / x8 / x16 / x32 speeds.

**FF:** Press repeatedly to fast forwards at x1 / x2 / x4 / x8 / x16 / x32 speeds.

**Repeat:** Press to select the repeat function you want.

Choose from NONE/ONE/SEQUENCE/RANDOM.

**TimePlay:** Allows you to select a time to start watching the programme from.

**Enlarge:** Allows you to enlarge the screen image programme. Use the ▲▼◀▶ buttons to move around the enlarged image.

**Shrink:** Allows you to shrink the screen image of the programme.

**Playlist:** Shows you a full list of films you can watch. Press the **EXIT** button to close the submenu.

**Info:** Shows information about the programme you are watching. Press the **EXIT** button to close the submenu.

If you require any technical guidance or find that your product is not operating as intended, a simple solution can often be found in the **Troubleshooting** section of these instructions.







# TV systems management

5



# TV systems management

Let's get started

## PICTURE MENU

This menu allows you to select the best preset picture mode or change them yourself.

**Note:** The menu shown in the diagram has been extended to show all available options. You will need to use the ▲▼ buttons to scroll through the menu to view all of the options.

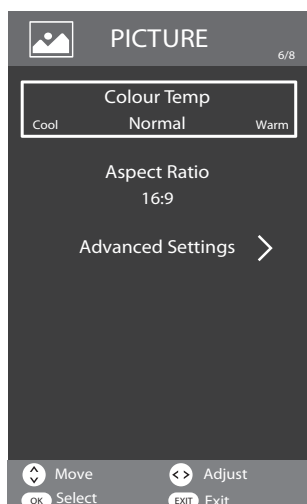
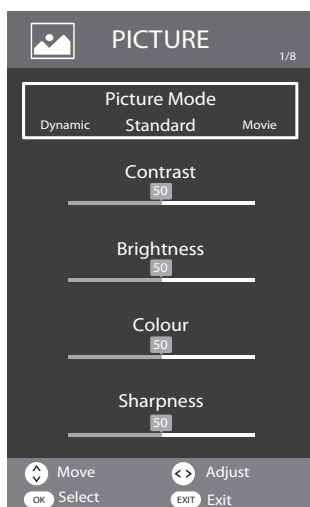

1. Press **MENU** button to display the main interface, then use ▲▼◀▶ buttons to navigate and select **PICTURE** menu and press **OK** button to enter.
2. Press ▲▼ buttons to select the following options and use ◀▶ buttons to adjust each option's setting.

**Picture Mode:** Choose between Dynamic / Standard / Movie / Personal modes.

**Contrast:** Adjusts the difference between light and dark levels in the picture.

**Brightness:** Increases or decreases the amount of white in the picture.

**Colour:** Adjust the value of colour.

**Sharpness:** Adjust the level of crispness in the edges between light and dark areas of the picture.

**Colour Temp:** Choose between Cool/Normal/Warm. The colour temp changes the amount of blue and red in your picture.

**Aspect Ratio:** Choose to view the TV picture in various formats. Choose from AUTO / 4:3 / 16:9 / Zoom 1 / Zoom 2.

**Advanced Settings:** Adjust the following options: Noise Reduction, White Balance, Blue Screen, Backlight, Gamma and Reset.

If you require any technical guidance or find that your product is not operating as intended, a simple solution can often be found in the **Troubleshooting** section of these instructions.

# TV systems management

Let's get started

## SOUND MENU

This menu allows you to select the best preset sound mode or change them yourself.

**Note:** The menu shown in the diagram has been extended to show all available options. You will need to use the ▲▼ buttons to scroll through the menu to view all of the options.

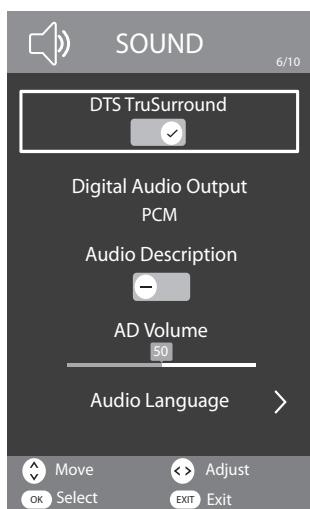
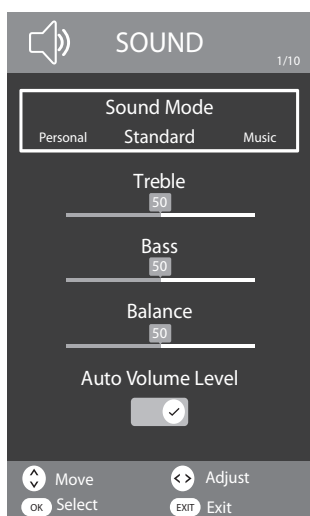

1. Press **MENU** button to display the main interface, then use ▲▼◀▶ buttons to navigate and select **SOUND** menu and press **OK** button to enter.
2. Press ▲▼ buttons to select the following options and use ◀▶ buttons to adjust each option's setting.

**Sound Mode:** Choose between Standard / Music / Movie / Sports / Personal modes.

**Treble:** Use to adjust the amount of treble in the TV's sound.

**Bass:** Use to adjust the amount of bass in the TV's sound.

**Balance:** Use to adjust the relative volume of the speakers in a multiple speaker system.

**Auto Volume Level:** Turn On/Off to automatically adjust volume levels (e.g. volume levels in adverts are generally louder than programmes).

**DTS TruSurround:** Switches the virtual surround sound feature on or off.

**Digital Audio Output:** Use when a digital audio connection is

attached to your TV. Select between PCM / Auto / Off.

**Audio Description:** Turn On or Off the audio description.

**AD Volume:** Use the to set the volume of the audio description.

**Audio Language:** Select audio language

**Note:** If you want to change the sound mode, repeatedly press **S.MODE** button on the remote control until you find the one you want.

### PLEASE NOTE

DTS TruSurround must be switched off to change Sound Mode and EQ settings. Adjusting any picture or sound settings will automatically change the mode to Personal. If you wish to reset all picture and sound adjustments: MENU>SETTINGS>Reset Factory Default.

# TV systems management

Let's get started

## CHANNEL MENU

This menu allows you to retune, edit your channel list, check your signal information, check your recorded and schedule lists and update your TV's software using the over air download system.

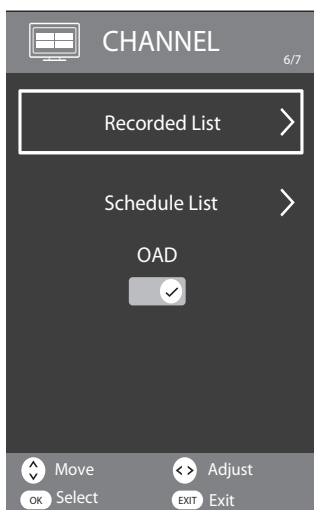
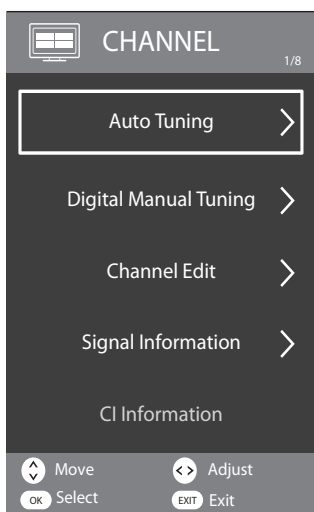

**Note:** The menu shown in the diagram has been extended to show all available options. You will need to use the ▲▼ buttons to scroll through the menu to view all of the options.

1. Press **MENU** button to display the main interface, then use ▲▼◀▶ buttons to navigate and select **CHANNEL** menu and press **OK** button to enter.
2. Press ▲▼ buttons to select the following options and use ◀▶ buttons to adjust each option's setting.

## Auto Tuning

1. Select the Auto Tuning submenu and press the **OK** button to confirm.

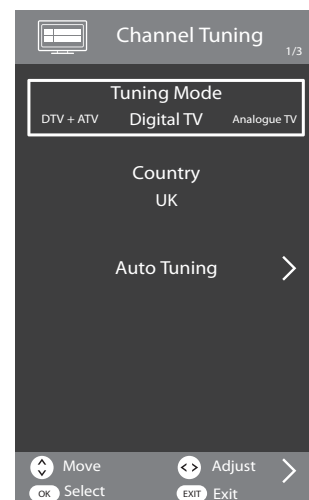

2. Use the ◀▶ buttons to select the tuning type among DTV+ATV/Digital TV/Analogue TV. Use the ◀▶ buttons to select the Country you are tuning the TV in.
3. Press the ▼ button and select Auto Tuning and press the ▶ or **OK** button to start the tuning process.
4. Once the tuning has finished you can set the Country, Region and Secondary Region using the ▲▼ buttons, confirm your selections by pressing the **OK** button. Once you have completed all of the settings the menu will close automatically.

If you require any technical guidance or find that your product is not operating as intended, a simple solution can often be found in the **Troubleshooting** section of these instructions.

# TV systems management

Let's get started

## Analogue Manual Tuning

(only available in ATV mode)

**IMPORTANT:** This feature is not available in the UK as analogue signals are no longer broadcast.

1. Press the ▲▼ buttons to select **Analogue Manual Tuning** and press **OK** to display the menu.
2. Use ▲▼ buttons to select the desired option and then use ◀▶ buttons to set each option.

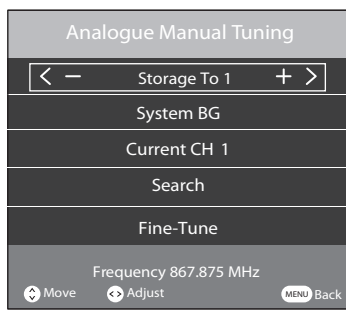

Storage: Select the storage location of the channel

System: Select system between I / DK / L / M / BG

Current CH: Display the current channel information

Search: To search through the different frequencies until you find the program you want.

Fine-Tune: select FINE-TUNE to do small adjustments to improve the signal

**IMPORTANT:** If the number about to save is the same as a channel that is already being used, the manually adjusted channel will replace the existing channel.

## Digital Manual Tuning

1. Use the ▼ button to select Digital Manual Tuning and press **OK** on the remote control to display the submenu.

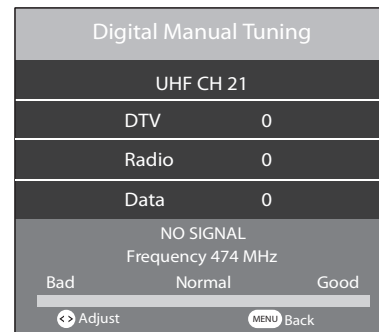

2. The Digital Manual Tuning menu will now display.
3. Press the ◀▶ buttons to select the desired UHF channel.
4. Press the **OK** button and the search for available stations on that channel will begin.
5. Once the signal has been tuned the signal strength will be displayed on the screen.
6. The menu will close and the tuned channel will be shown on your TV screen.

# TV systems management

Let's get started

## Channel Edit

Allows you to edit TV channel information in the Channel List.

1. Press the **MENU** button to display the main interface and then select **CHANNEL** menu to enter the Channel Edit.



2. Press the **▼** button to select **Channel Edit** and press the **OK** button on the remote control to open the submenu.

**Delete:** Highlight the channel you want to delete using the **▲▼** buttons. Press the **RED** button on the remote control to delete the programme from the **EPG** menu.

**Rename:** Use the **▲▼** buttons to highlight the channel you want to rename in the **EPG** menu and press the **GREEN** button on the remote control to rename.(only available in **ATV** mode)

**Move:** Use the **▲▼** buttons to highlight the channel you want to move in the **EPG** menu and press the **YELLOW** button on the remote control. Move the channel to the position you want it in and press the yellow button again.

**Skip:** Use the **▲▼** buttons to highlight the channel you want to skip in the **EPG** menu and press the **BLUE** button on the remote control.

**Fav:** Select the channels you want to add to your favourites list using the **▲▼** buttons then press the **FAV** button on the remote control to confirm.

## Signal Information

Allows you to view the signal strength of the selected channel TV signals.

## CI (Common Interface)

### Digital TV channels only

This function allows you to view the common interface module information.

**Important:** Do not keep removing and Resetting the Common Access Module as it could damage the interface and cause a malfunction.

If you require any technical guidance or find that your product is not operating as intended, a simple solution can often be found in the **Troubleshooting** section of these instructions.



# TV systems management

Let's get started

## Recorded List

Use the ▼ button to select Recorded List from the menu and press the **OK** button to display the menu.

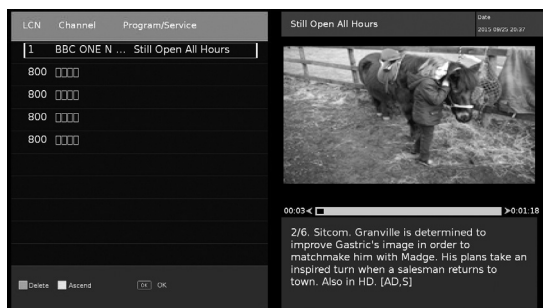

You can now see a full list of all of the programmes recorded on your USB drive and also interact with the list using the coloured buttons on the remote control.

**Note:** If there is no USB storage device fitted to the TV a warning message **No USB device detected!** will be shown, press the **EXIT** button on the remote control to close the Recorded List menu.

## Schedule List

Use the ▼ button to select Scheduled List from the menu and press the **OK** button to display the menu.

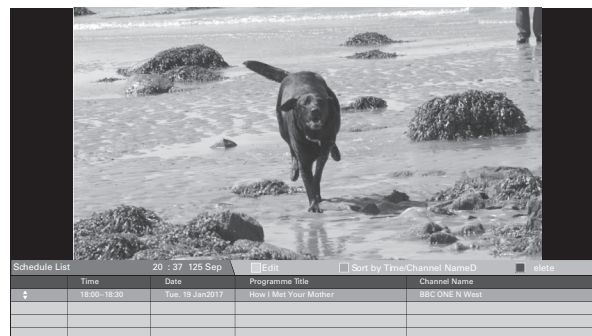

You can now see a full list of all of the programmes you have scheduled and also interact with the list using the coloured buttons on the remote control.

## OAD (Software Update)

(Over Air Download)

Digital TV (DTV) channels only

The TV auto detects the latest firmware update through the DTV signal and allows you to accept or refuse the firmware upgrade service.

# TV systems management

## Let's get started

1. Press the **MENU** button to display the main interface and then select **CHANNEL** menu to enter. Use ◀▶ buttons to select OAD.
2. During normal DTV viewing, if the TV detects an update to the firmware from the DTV signal, the Over Air Download screen will appear. Use the ◀▶ buttons to select either Yes or No.

**Note:** If you do not press any button within 1 minute, the Over Air Download screen will disappear. The Over Air Download screen will appear next time you switch to viewing a DTV channel.

## LOCK MENU

You will have to enter your password or the default password is **0000** before you can change any of the settings in the lock menu.

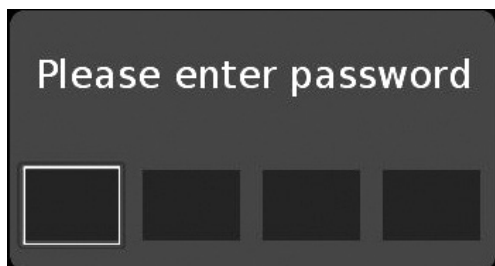

1. Press **MENU** button to display the main interface, then use ▲▼◀▶ buttons to navigate and select **LOCK** menu and press **OK** button to enter.
2. Press ▲▼ buttons to select the following options and use ◀▶ buttons to adjust each option's setting.

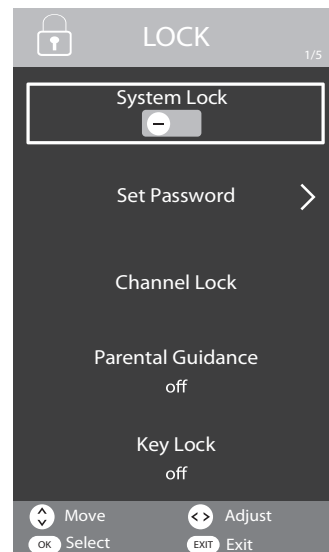

### System Lock

Select to turn On/Off system lock. The following options (Channel Lock, Parental Guidance and Key Lock) will only be accessible when you turn the system lock on.

### Set Password

Use the ▼ button to select Set Password then press the **OK** button. Use the **0** to **9** buttons on the remote control to enter your password or the default **0000** password.

Press the ▼ button and enter your new password using the **0** to **9** buttons. Press the ▼ button and enter your new password again using the **0** to **9** buttons.

Your new password has now been saved and the submenu will close.

If you require any technical guidance or find that your product is not operating as intended, a simple solution can often be found in the **Troubleshooting** section of these instructions.

# TV systems management

## Let's get started

**Note:** 0000 is the master password and can always be used.

### Channel Lock

Use the ▼ button to select channel lock then press the OK button. Scroll through the list of available channels using the ▲▼ buttons.

When you have highlighted the channel you wish to lock press GREEN button along the bottom of remote control. Green button at the top of the remote is the MUTE button.

**Noted:** The locked channels do still appear but are unselectable in EPG menu.

### Parental Guidance

Use the ▼ button to select Parental Guidance then press the OK button. Parental guidance is used to set an age rating for programmes on the TV before the password is required to watch the program.

Scroll through the list of available ages using the ◀▶ buttons.

Choose the age rating you want and press the OK button to confirm.

### Key lock

Use to lock the remote control, you must enter the password before the remote control will function.

Turn key lock on and off by pressing the OK button.

## TIME MENU

1. Press MENU button to display the main interface, then use ▲▼◀▶ buttons to navigate and select TIME menu and press OK button to enter.
2. Press ▲▼ buttons to select the following options and use ◀▶ buttons to adjust each option's setting.

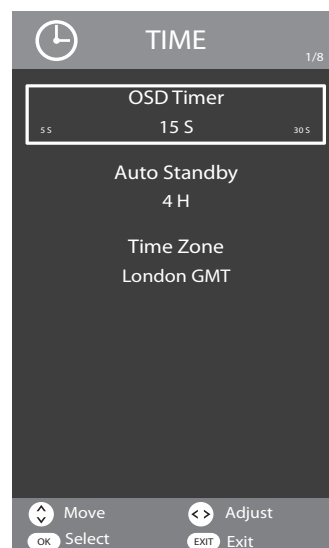
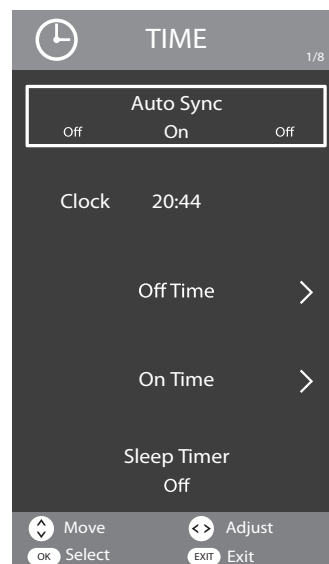

### Auto Sync

When Auto Sync is switched on, the TV will take the time from signals received by the TV through the broadcast signals.

Use the ◀▶ buttons to switch the Auto Sync On or Off.

### Clock

You can only use the clock feature if Auto Sync is set to Off.

Highlight Clock using the ▲▼ buttons then press the OK button. You will now enter the Clock submenu.

Use the ▲▼ buttons to navigate through the menu.

# TV systems management

## Let's get started

Set the Year / Month / Day / Minute using the ◀▶ buttons then press the **OK** button confirm and return to the main menu.

### Off Time

This feature will automatically turn the TV off at a specified time and on specified days.

Use the ▼ button to select Off Time then press the **OK** to display the submenu.

Use the ◀▶ buttons to choose between Off / Once / Everyday / Mon~Fri / Mon~Sat / Sat~Sun / Sun.

Press ▼ the button and set the hour/minute using the ◀▶ buttons.

After you have finished setting the Off Time, press the

**MENU** button to return to the **TIME** menu.

### On Time

This feature will automatically turn the TV on at a specified time.

Use the ▼ button to select On Time then press the **OK** to display the submenu.

Use the ◀▶ buttons to choose between Off / Once / Everyday / Mon~Fri / Mon~Sat / Sat~Sun / Sun.

Press ▼ the button and set the hour/minute using the ◀▶ buttons.

Press ▼ the button and select the input source using the ◀▶ buttons. Choose between DBVT digital TV/ Analogue TV/DBVT Radio/DBVT Data/ SCART/ Component/YPbPr/PC/ HDMI1/ HDMI2/ HDMI3/ Composite/AV.

Press ▼ the button and select a channel for TV or Radio using the ▼ buttons. Press ▼ the button and set the volume using the ◀▶ buttons.

After you have finished setting the On Time, press the

**MENU** button to return to the main **TIME** menu.

### Sleep Timer

This feature will automatically turn the TV into sleep mode after a set time if no control buttons are pressed.

Use the ▲▼ buttons to choose between Off /10/20/30/60/90/120/180/240 minutes.

After you have finished setting the sleep timer, press the

**MENU** button to return to the main **TIME** menu.

### OSD Timer

This feature will display how long the On Screen Display will be

shown for.

Use the ▲▼ buttons to choose between off / 5 / 15 / 30 / 60 seconds.

After you have finished setting the sleep timer, press the

**MENU** button to return to the main **TIME** menu.

### Auto Standby

This feature will automatically turn the TV off and into standby mode if no control or button is pressed. Choose from Off / 3 Hours / 4 Hours / 5 Hours using the ▲▼ buttons.

After you have finished setting the Auto Standby, press the

**MENU** button to return to the main **TIME** menu.

### Time zone

This feature can only be used if Auto Sync is set to On.

Use to set the time zone the TV is being used in.

Use the ▼ button to select Time Zone then press the **OK** button to enter.

Use the ▲▼◀▶ buttons to select the local time zone then press the **OK** button.

If you require any technical guidance or find that your product is not operating as intended, a simple solution can often be found in the **Troubleshooting** section of these instructions.

# TV systems management

Let's get started

## SETTINGS MENU

**Note:** The menu shown in the diagram has been extended to show all available options. You will need to use the ▲▼ buttons to scroll through the menu to view all of the options.

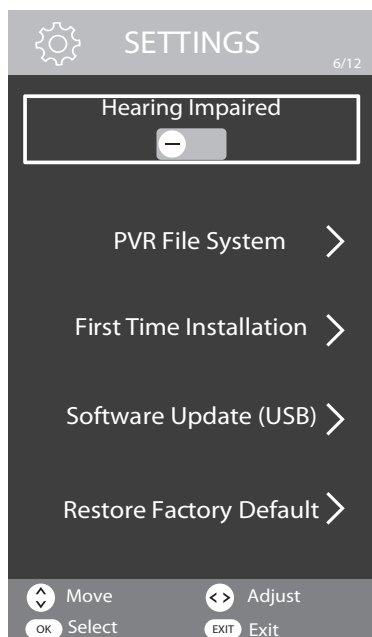
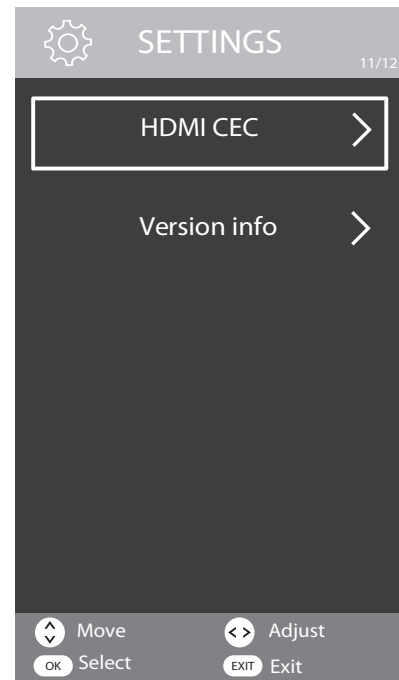

1. Press **MENU** button to display the main interface, then use ▲▼◀▶ buttons to navigate and select **SETTINGS** menu and press **OK** button to enter.
2. Press ▲▼ buttons to select the following options and use ◀▶ buttons to adjust each option's setting.

# TV systems management

## Let's get started

### Language

The on screen display language is set to English .

#### Audio Languages/ Audio Languages2

Audio Language is the language certain items are played in, depending on availability.

Press the ▼ button to select the Audio Language. Press the OK button to the sub menu, then use the ◀▶ buttons to select either Primary or Secondary then press the ◀▶ button.

Select your preferred language from the selection using the ▲▼◀▶ buttons, press the OK button to confirm. Press the MENU button to return to the SETTINGS menu.

#### Subtitle Language/ Subtitle Language 2

Subtitle Language is the language certain items are played in, depending on availability.

Press the ▼ button to select the Audio Language. Use the ◀▶ buttons to select either Primary or Secondary then press the ▼ button.

Select your preferred language from the selection using the ▲▼◀▶ buttons, press the OK button to confirm.

Press the MENU button to return to the SETTINGS menu.

### Hearing Impaired

Shows additional information for people with impaired hearing when switched on (if supported by the broadcaster). Use the ▼ button to select Hearing Impaired then use the OK button to switch On or Off.

### PVR File System

Use the ▼ button to select PVR File System then press the OK button to open the PVR File System submenu.

**Select Disk:** Lets you select the USB drive you wish to check using the ◀▶ buttons. You can then select which disk to check using the ◀▶ buttons.

**Timeshift Size:** This lets you choose the amount of memory the Timeshift function can use on a connected USB device. Choose between 512MB / 1GB / 2GB / 4GB using the ◀▶ buttons.

**Format Start:** Use this to reformat the USB drive, press the OK button to start.

**Speed Check:** Use this feature to check the speed of your USB drive by pressing the OK button.

### First Time Installation

Use the ▼ button to select First Time Installation then press the OK button.

This will now rescan all available TV and radio channels.

### Software Update (USB)

Insert the USB drive with the update on it into one of the USB ports on your TV then turn your TV on by pressing the power button. Follow the on screen information to update your TV.

If you require any technical guidance or find that your product is not operating as intended, a simple solution can often be found in the **Troubleshooting** section of these instructions.

# TV systems management

Let's get started

## Restore Factory Default

Select to restore the TV to factory default. A warning window will pop up asking if you wish to reset the TV to the factory settings, select YES or NO to reset the TV or not.

## HDMI CEC

Turn on Consumer Electronics Control (CEC) so that you can control up-to 15 CEC-enabled devices that are connected through HDMI directly from one remote control.

**Please note:** CEC also allows for individual CEC-enabled devices to command and control each other without your intervention.

## Version Info

Display the current software version information.





# Entertainment Features



# Entertainment Features

Let's get started

## USING THE USB FEATURES

1. Always switch the TV off before attaching a USB storage device to your TV.
2. Connect the USB storage device to one of the USB ports on your TV.
3. Press the **⏻** button on the remote control or TV to turn the TV on.
4. Press the **Menu** button on your remote control. Use the **▲▼◀▶** buttons to select **USB MEDIA** from menu then press the **OK** button to open.

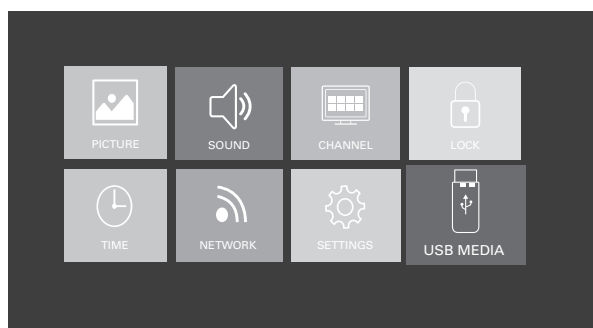

**IMPORTANT:** Some portable USB hard disks may require more power than the TV's USB port can supply. To ensure the correct operation of the USB hard disk please use an appropriate power adapter with the hard disk. If you are using a USB Hub, please ensure its mains adapter is connected to the mains supply as the total current consumption may exceed 500mA, the maximum the TV can supply.

The file system only supports FAT32 format.

If you want to keep recorded DTV programmes the transfer rate of the storage device must not be less than 5MB/s, otherwise the picture and sound of the programme will be affected and a warning statement will be shown on the TV's screen. If this happens please upgrade your USB storage device.

Your TV screen will go temporarily blank when you start recording as it takes a few seconds to stabilize the connection to the USB storage device.

Always disconnect the USB storage device if it is not going to be used for extended periods.

# Entertainment Features

Let's get started

## Viewing Movies

Use the ◀▶ buttons to select **Movies** folder then press the **OK** button.

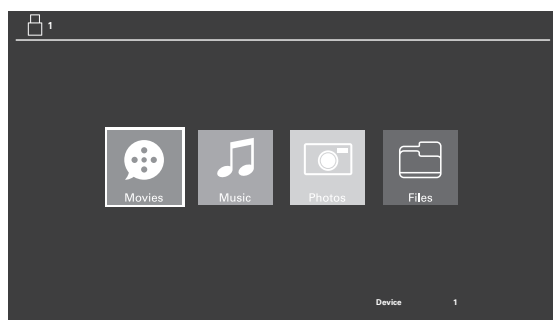

Use the ◀▶ buttons to select the USB device you want to look in (if more than one device is connected to your TV) then press the **OK** button.

Use the ▲▼◀▶ buttons to navigate to the **Folder or file** and press the **OK** button to open.

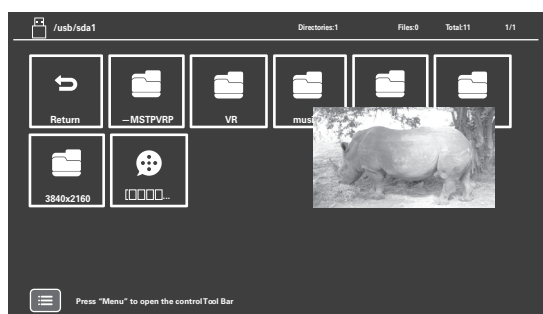

Use the ▲▼◀▶ buttons to find the movie you want to watch, then press **OK** or ▶|| button to play it in full screen.

If you press the menu button on the remote control when the movie is playing, the Movie Function Bar will be displayed.

Use the ◀▶ buttons to select the different functions available on the function bar, press the **OK** button to select the function.

## List of functions



**Previous:** Press to watch the previous programme in the playlist.

**Next:** Press to watch the next programme in the play list.

**Play/Pause:** Press to play/pause the programme.

**Stop:** Press to play back of the programme.

**FB:** Press repeatedly to rewind at x2 / x4 / x8 / x16 / x32 speeds.

**FF:** Press repeatedly to fast forwards at x1 / x2 / x4 / x8 / x16 / x32 speeds.

**Repeat:** Press to select the repeat function you want.

Choose from NONE/ONE/SEQUENCE/RANDOM.

**TimePlay:** Allows you to select a time to start watching the programme from.

**Enlarge:** Allows you to enlarge the screen image programme.

**Shrink:** Allows you to shrink the screen image of the programme.

**Playlist:** Shows you a full list of films you can watch. Press the **EXIT** button to mclose the submenu.

**Info:** Shows information about the programme you are watching. Press the **EXIT** button to close the submenu.

# Entertainment Features

Let's get started

## Listening to Music

Use the ◀▶ buttons to select **Music** folder then press the **OK** button.

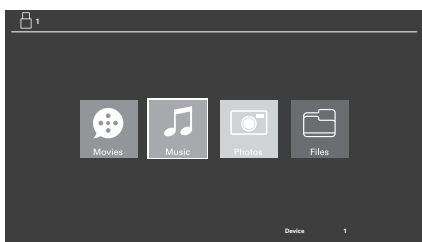

Use the ◀▶ buttons to select the USB device you want to look in (if more than one device is connected to your TV) then press the **OK** button.

Use the ▲▼◀▶ buttons to navigate through the folders and press the **OK** button to open the folder.

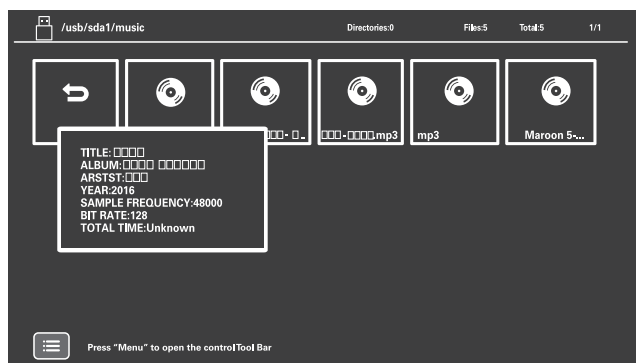

When you find the music track you want to listen to, press the **OK** or ▶|| buttons to begin listening to it.

If you press the menu button on the remote control when the movie is playing the Movie Function Bar will be displayed.

Use the ◀▶ buttons to select the different functions available on the function bar, press the **OK** button to select the function.

## List of functions



**Previous:** Press to skip to previous track.

**Next:** Press to move to next track.

**Play/Pause:** Press to play/pause the programme.

**Stop:** Press to stop the track.

**FB:** Press to rewind the track.

**FF:** Use to fast forward the track.

**Repeat:** Press to select the repeat function you want. Choose from NONE/ONE/SEQUENCE/RANDOM.

**Playlist:** Shows you a full play list. Press **EXIT** button to close.

**Info:** Shows information about the track. Press **EXIT** button to close.

**TimePlay:** Allows you to select a time to start Listening the programme from.

Press the **MENU** button to hide and show the function bar.

Press the **EXIT** button to go back to the main USB menu.

If you require any technical guidance or find that your product is not operating as intended, a simple solution can often be found in the **Troubleshooting** section of these instructions.

# Entertainment Features

Let's get started

## Viewing Photos

Use the ◀▶ buttons to select **Photo** folder then press the **OK** button.

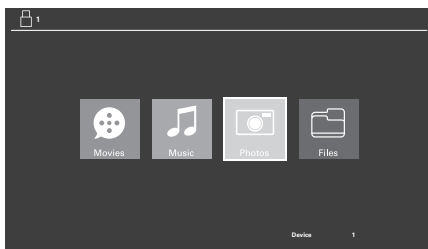

Use the ◀▶ buttons to select the USB device you want to look in (if more than one device is connected to your TV) then press the **OK** button.

Use the ▲▼◀▶ buttons to navigate through the folders and press the **OK** button to open the folder.

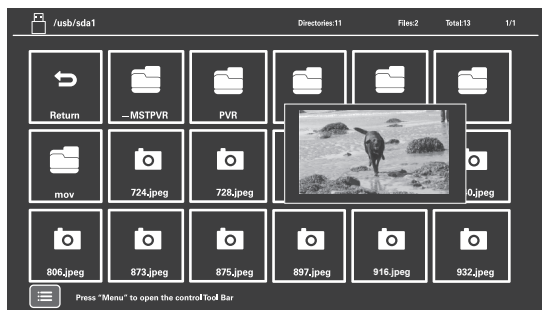

When you find the photo you want to see to press the **OK** or ▶|| button to view it.

If you press the menu button on the remote control when the movie is playing the Movie Function Bar will be displayed.

Use the ◀▶ buttons to select the different functions available on the function bar, press the **OK** button to select the function.

## List of functions



**Previous:** Press to view the previous photo.

**Next:** Press to view the next photo.

**Play/Pause:** Press to play/pause the programme.

**Stop:** Press to go back to the menu.

**Rotate -:** Press to rotate clockwise.

**Rotate +:** Press to rotate anti clockwise.

**Enlarge:** Press to shrink the image.

**Shrink:** Allows you to shrink the screen image of the programme.

**Move:** Use the ▲▼◀▶ buttons to move around the image.

Press the **EXIT** button to close

**Repeat:** Press to select the repeat function you want.

Choose from NONE/ONE/SEQUENCE/RANDOM.

**BGM:** If you have music on the USB drive it will be played when viewing the photos.

**Play List:** Shows a list of all available photos. Press **EXIT** to close the sub menu.

**Info:** Press to view information about the photo you are viewing. Press **EXIT** to close the sub menu.

Press the **MENU** button to hide and show the function bar.

Press the **EXIT** button to go back to the main USB menu.

# Entertainment Features

Let's get started

## Viewing Files

Use the ◀▶ buttons to select **Files** folder then press the **OK** button.

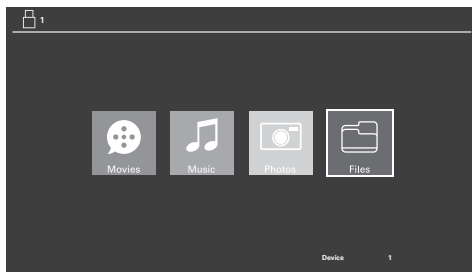

Use the ◀▶ buttons to select the USB device you want to look in (if more than one device is connected to your TV) then press the **OK** button.

Use the ▲▼◀▶ buttons to navigate through the folders and press the **OK** button to open the folder.

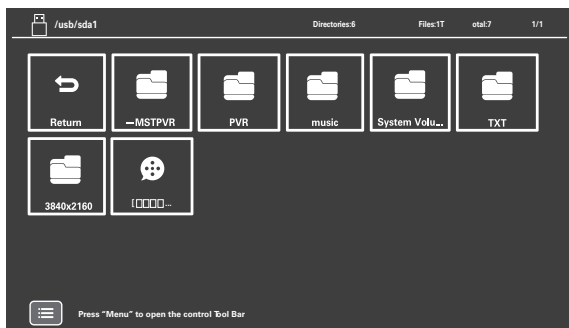

When you find the text file you want to see to press the **OK** button.

Press the **EXIT** button to go back to the main USB menu.

If you require any technical guidance or find that your product is not operating as intended, a simple solution can often be found in the **Troubleshooting** section of these instructions.







Other information

7



# Other information

## Helpful technical information

Specifications	
TV Broadcasting	PAL, B/G, D/K, I, SECAM, L/L'
Receiving Channels	VHF (BAND I/III) - UHF (BAND U) - HYPERBAND
Number of Preset Channels	100
Channel Indicator	On Screen Display
RF Aerial Input	75 Ohm (unbalanced)
Operating Voltage	AC 100-240V~ 50/60Hz
Audio	Nicam
Audio Output Power (WRMS.) (10% THD)	2x8W
Panel Dimensions DxLxH (with foot)	200 x 634 x 419 mm
Weight (with foot)	3.5 kg
Panel Dimensions DxLxH (without foot)	87 x 634 x 386 mm
Weight (without foot)	3.4 kg
Energy Consumption Data	EEIA
On Mode Power Consumption (W)	30W
Standby Mode (W)	0.5W
Maximum Power (W)	50W
Standby Mode	After 4 Hours

Digital reception
MHEG-5 ENGINE compliant with ISO/IEC 13522-5 UK engine Profile 1 - for UK
Object carousel support compliant with ISO/IEC 135818-6 and UK DTT profile - for UK
Frequency range: 474-850 MHz for UK models
170-862 MHz for EU models
Transmission standard: DVB-T. MPEG-2
Demodulation: COFDM with 2K/8K FFT mode
FEC: all DVB modes
Video: MP@ML, PAL, 4:3/16:9
Audio: MPEG Layer I&II 32/44.148kHz.

We apologise for any inconvenience caused by any minor inconsistencies in these instructions, which may occur as a result of product improvements and development.

If you require any technical guidance or find that your product is not operating as intended, a simple solution can often be found in the **Troubleshooting** section of these instructions.

# Other information

## Helpful technical information

### Plug replacement - UK and Ireland only

Should you need to replace the plug; the wires in the power cable are coloured in the following way:

Blue – Neutral 'N'

Brown – Live 'L'

As the colours of the wires in the power cable may not correspond with the coloured markings identifying the terminals in your plug, and proceed as follows:

The blue wire must be connected to the terminal that is marked with the letter N.

The brown wire must be connected to the terminal that is marked with the letter L.

If the power lead is damaged, it must be replaced by a qualified electrician.

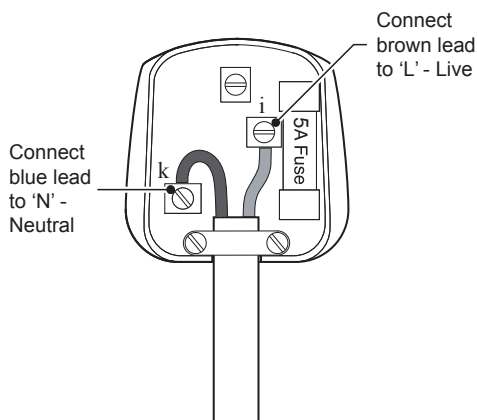

### Energy label

This is called the product Fiche – the information needs to be presented in the following order, also this may be in the form of a copy of the label, in colour or black and white – the label however must display all the information below:

- Supplier's name or trade mark
- Supplier's model product model no.
- The energy efficiency class of the model
- The visible screen diagonal in centimetres and in inches
- The on-mode power consumption
- The annual energy consumption
- The screen resolution in physical horizontal and vertical pixel count



Product Support

8



# Product support

Help is always at hand

## Trouble shooting

### Image persistence - ghosting

Please note that ghosting may occur while displaying a persistent image (still or paused image). LCD TVs' image persistence may disappear after a short time. Try turning off the TV for a while. To avoid this, do not leave the screen in still picture mode for extended periods.

### No power

If your TV has no power, please check the power cord plug is connect to the mains power socket.

### Poor picture

1. Have you selected the correct TV system?
2. Is your TV or house aerial located too close to a non-earthed audio equipment or neon lights, etc.?
3. Mountains or high buildings can cause double pictures or ghost images. Sometimes you can improve the picture quality by changing the direction of the aerial. Is the picture or teletext unrecognisable?
4. Check if you have entered the correct frequency.
5. Please retune the channels.
6. The picture quality may degrade when two devices are connected to the TV at the same time. In such a case, disconnect one of the devices.

### No picture

1. No Picture means that your TV is not receiving a transmission. Have you selected the correct button on the remote control? Try once more. Also make sure the correct input source has been selected.
2. Is the aerial connected properly?
3. Are the plugs connected tightly to the aerial socket?
4. Is the aerial cable damaged?
5. Are suitable plugs used to connect the aerial?
6. If you are in doubt, consult your dealer.

### No sound

1. Has the TV been set to mute? To cancel mute, press the "M" button, or increase the volume level.
2. Sound is coming from only one speaker. Is the balance set to one extreme?

### Remote control - does not operate

Your TV no longer responds to the remote control. The batteries may be exhausted, if so you can still use the control buttons on the left side of the TV.

### Input sources - can not be selected

1. If you cannot select an input source, it is possible that no device is connected.
2. Check the AV cables and connections if you have tried to connect a device.

### The DVD picture quality is poor

1. Make sure the DVD disc surface is not damaged (no scratches, fingerprint etc.).
2. Clean the DVD disc and try again. See instructions in "Cleaning Discs" to clean your disc properly page 00.
3. Ensure that the DVD disc is in the loader with the label facing you when looking at the TV screen.
4. A damp DVD disc or condensation may effect the equipment. Wait for 1 to 2 hours in Stand-by mode to dry the equipment.

### The Disc does not play

1. No disc in the machine - Place a disc into the loader.
2. Disc is incorrectly loaded - Ensure that the DVD disc is in the loader with the label facing you when looking at the TV screen.
3. Wrong type of disc. The DVD player cannot play CD-ROMS etc..
4. The region code of the DVD disc must match the player.

### Wrong OSD language

1. Select the language in the setup menu.
2. The language for the sound or subtitles on a DVD disc cannot be changed.
3. Multilingual sound and/or subtitles are not recorded on the DVD disc.
4. Try to change the sound or subtitles using DVD's title menu. Some DVD's do not allow the user to change these settings without using the disc's menu.



If you require any technical guidance or find that your product is not operating as intended, a simple solution can often be found in the **Troubleshooting** section of these instructions.

# Product support

Help is always at hand

## Definition of terms

### Angle

Recorded onto some DVD discs are scenes, which have been simultaneously shot from a number of different angles (the same scene is shot from the front, from the left side, from the right side, etc.). With such discs, the ANGLE button can be used to view the scene from different angles.

### Chapter Number

These numbers are recorded on DVD discs. A title is subdivided into many sections, each of which are numbered, and specific parts of video presentations can be searched quickly using these numbers.

### Chapter Number

This refers to a high-density optical disc on which high quality pictures and sound have been recorded by means of digital signals. Incorporating a new video compression technology (MPEG II) and high-density recording technology. DVD discs enable aesthetically pleasing full motion video to be recorded over long periods of time (for instance, a whole movie can be recorded).

DVD discs have a structure consisting of two 0.6mm thin discs, which are adhered to each other. Since the thinner the disc, the higher the density at which the information can be recorded, a DVD disc has a greater capacity than a single 1.2mm thick disc. Since the two thin discs are adhered to each other, there is the potential to achieve double-sided play sometime in the future for even longer duration play.

### Subtitles

These are lines of text appearing at the bottom of the screen, which translate or transcribe the dialogue.

They are recorded on the DVD discs.

### Time Number

This indicates the playtime, which has elapsed from the start of a disc or a title. It can be used to find a specific feature to be used. Availability is determined by the disc's manufacturer.)

### Title Number

These numbers are recorded on DVD discs. When a disc contains two or more movies, these movies are numbered as title 1, title 2, etc.

### Track Number

These numbers are assigned to the tracks, which are recorded on Audio CDs. They enable specific tracks to be located quickly.

### LPCM

LPCM stands for Pulse Code Modulation and is digital audio.

### MPEG

Short for Moving Picture Experts Group. This is an international standard for compression of moving images. On some DVDs digital audio has been compressed and recorded in this format.

- minimum 10cm distances around the apparatus for sufficient ventilation;
- the ventilation should not be impeded by covering the ventilation openings with items, such as newspapers, table-cloths, curtains, etc.;
- no naked flame sources, such as lighted candles, should be placed on the apparatus;
- attention should be drawn to the environmental aspects of battery disposal.

# Product support

Help is always at hand

## Supported file formats

Media	File Extension	Format		Supported (Maximum resolution/Bit rate etc.)
		Video	Audio	
Movie	.mpg/.dat/.vob	MPEG1	MPEG Layer 1/2/3	
		MPEG2	MPEG2	
		MPEG2	MPEG2	
Music	-	-	PMC	Sample Rate: 8K ~ 48KHz
	.mp3	-	MPEG 1/2 Layer 1/2/3 MP3)	Sample Rate: 8K ~ 48KHz, Bit Rate: 64K ~ 320Kbps
Photo	.jpg	Baseline JPEG		W x H = 8192 x 8192 up to 77 Mega-pixel Support format: 444/ 440/ 422/ 420/ Grayscale
		Progressive JPEG		Up to 4 Mega-pixel Support format: 444/ 440/ 422/ 420/ Grayscale

## Disposal information

### Instructions for waste disposal:

Packaging and packaging aids are recyclable and should principally be recycled. Packaging materials, such as foil bag, must be kept away from children.

Information for Users on Disposal of old Equipment and Batteries (European Union only)

These symbols indicate that equipment with these symbols should not be disposed of as general household waste. If you want to dispose of the product or battery, please consider the collection systems or facilities for appropriate recycling.

**Notice:** The sign Pb below the symbol for batteries indicates that this battery contains lead.



Products



Battery

The cold cathode fluorescent lamp in LCD PANEL contains a small amount of mercury; please follow the local laws or regulations for disposal.

Information for Users in European Union Countries

This symbol on the product or on its packaging means that your electrical and electronic device should be disposed of at the end of its service life separately from your household wastes. There are separate collection systems for recycling in EU.

For more information, please contact the local authority or the dealer where you purchased the product.



If you require any technical guidance or find that your product is not operating as intended, a simple solution can often be found in the **Troubleshooting** section of these instructions.



# Product support

Help is always at hand

## Help and assistance

If you require any technical guidance or find that your TV is not operating as intended, a simple solution can often be found in the **Troubleshooting** section of these instructions or online at [www.argos-support.co.uk](http://www.argos-support.co.uk)

If you still require further assistance, call one of our experts on **0345 604 0105\***. To help give us give you a fast and efficient service please have the following information ready:

<b>Model Ref.</b>	<input type="text"/>	You can find these on the rating plate - a small information panel (usually a sticker or metal plate) on the rear of your product
<b>Serial number</b>	<input type="text"/>	
<b>Date of purchase</b>	<input type="text"/>	

Local call rates applies\*

**Lines open 8am-7pm Monday to Saturday and 10am-4pm Sunday.**

\*Calls to Argos enquiry lines may attract a charge and set up fee from residential lines depending on your call plan/tariff. Mobile and other providers costs may vary, see [www.bt.com/pricing](http://www.bt.com/pricing) for details.

For security and training purposes, telephone calls to and from customer service centres may be recorded and monitored. Calls from Republic of Ireland will attract international call charges.

**We hereby declare that ALBA 28"HD ready LED TV 7119774 is in compliance with the essential requirements and other relevant provisions of Directive 2014/53/EU.**

or online at [www.argos-support.co.uk](http://www.argos-support.co.uk) If you still require further assistance, call one of our experts on **0345 604 0105**.

# Product support

Help is always at hand

## Disposal



This product contains electrical or electronic materials. The presence of these materials may, if not disposed of properly, have potential adverse effects on the environment and human health. Presence of this label on the product means it should not be disposed of as unsorted waste and must be collected separately. As a consumer, you are responsible for ensuring that this product is disposed of properly.



For DTS patents, see <http://patents.dts.com>. Manufactured under license from DTS Licensing Limited. DTS, the Symbol, DTS and the Symbol together are registered trademarks, and DTS TruSurround is a trademark of DTS, Inc. © DTS, Inc. All Rights Reserved.

**If you are creating instructions, you may find the following links helpful:**

[www.environmentlaw.org.uk](http://www.environmentlaw.org.uk)

[www.hse.gov.uk/waste/waste-electrical](http://www.hse.gov.uk/waste/waste-electrical)

If you require any technical guidance or find that your product is not operating as intended, a simple solution can often be found in the **Troubleshooting** section of these instructions.

# Product support

Help is always at hand



## Your Alba Guarantee

This product is guaranteed for twelve months from the date of original purchase. Any defect that arises due to faulty materials or workmanship will be repaired free of charge (or if applicable the product will be replaced or the purchase price refunded) where possible during this period by the dealer from who your purchased the unit.

### The guarantee is subject to the following provisions:

- The guarantee does not cover accidental damage, misuse, cabinet parts, knobs or consumable items.
- The product must be correctly installed and operated in accordance with the instructions contained in the manual.
- It must be used solely for domestic purposes. The guarantee will be rendered invalid if the product is re-sold or has been damaged by inexpert repair.
- Specifications are subject to change without notice.
- Alba disclaim any liability for loss or damage arising from the breakdown of the product.
- This guarantee is in addition to and does not diminish your statutory or legal rights.

Guarantor: Argos Limited - 489 - 499 Avebury Blvd. - Milton Keynes - MK9 2NW

or online at [www.argos-support.co.uk](http://www.argos-support.co.uk) If you still require further assistance, call one of our experts on **0345 604 0105**.

# ALBA



Contact:

[www.argos-support.co.uk](http://www.argos-support.co.uk)

Helpline: 0345 604 0105

