

BUSH

Customer Service Manual

Fridge - Freezer
F54180FFWTDB
F54180FFWTDS
F54180FFWTDW



Customer service manual

Fridge-Freezer

Contents

1	Precautions	Page 2
2	Glass Shelf Change	Page 4
3	Foldable Glass Shelf Change	Page 5
4	Flap Cover Change	Page 6
5	Door Shelf Change	Page 7
6	Adjustable Door Shelf Change	Page 8
7	Basket, Chiller, Crisper Change	Page 9
8	Maxifresh Change	Page 10
9	Door Gasket Change	Page 11
10	Reversing the door	Page 12
11	Water Tank	Page 14
12	Additional Support	Page 15

Precautions:

Always follow safety advice.

Always switch off and unplug the appliance before attempting to remove any part.

Always wear appropriate protective equipment when carrying out any work.

Always use the correct tools for carrying out any work.

Some repairs may not be suitable for unqualified users to carry out. If in doubt seek the advice of a profession repairer.

SAFETY PRECAUTIONS



Read all instructions before repairing the product.

Before any disassembly make sure appliance is unplugged.

There is electrical shock risk.

Use rated control equipment.

DO NOT attempt a product repair if you have any doubts as to your ability to complete the repair in a safe and satisfactory manner.

Make sure to check out Model name, Rated voltage, Rated current, Operation Temp, etc.

When you replace the parts, please use authentic parts to replace defective parts.

Before starting the dismantling, wear protective equipment.

Do not use multiple receptacles or extension cord.

Do not plug in damaged, torn or old plugs.

Do not allow children to play with the appliance or let them hang off the door.

Do not plug-in or out the plug from the receptacle with wet hands to prevent electrocution.

Do not place glass bottles or beverage cans in the freezer department. Bottles or cans may explode.

When taking ice made in the freezer department, do not touch it, ice may cause ice burns and/or cuts.

Do not cover the body or top of fridge with lace. This affects the performance of your fridge.

Fix the accessories in the fridge during transportation to prevent damage to accessories.

Leave to stand for at least before switching on to allow compressor oil to settle if transported horizontally.

Do not damage the refrigerant circuit.

Care must be taken while cleaning/carrying the appliance not to touch the bottom of the condenser metal wires at the back of the appliance, as this could cause injury to fingers and hands.

REPLACEMENT PROCEDURE		Applicable models	EN
		General	
Part name	Glass Shelf Change		

First gently lift the front side of glass up. Then you can pull the glass out by directly pulling towards yourself.

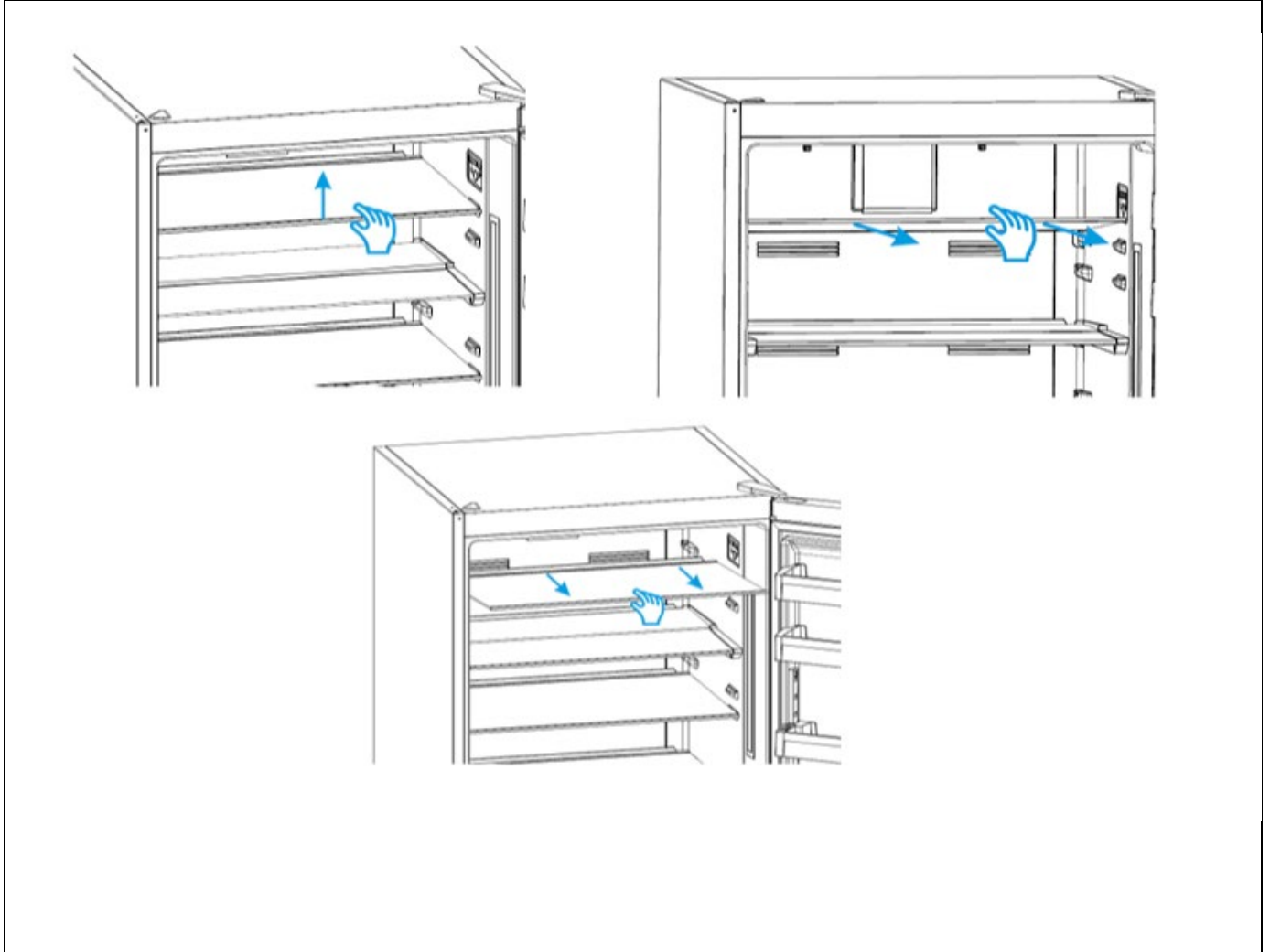

REPLACEMENT PROCEDURE		Applicable models	EN
		General	
Part name	Foldable Glass Shelf Change		

First push the glass in front to all the way back. Then gently lift both glasses up together. Now you can pull glasses out by directly pulling towards yourself.

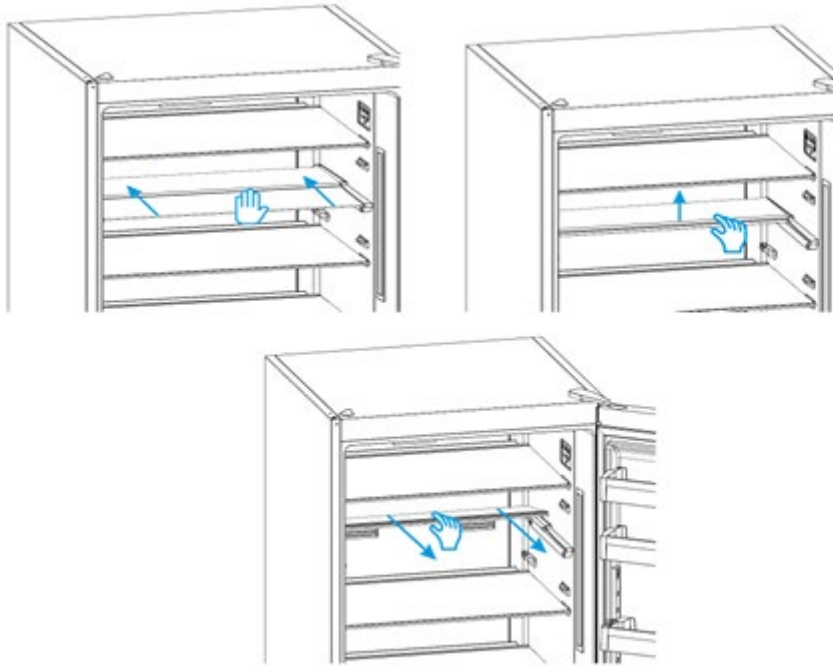

REPLACEMENT PROCEDURE		Applicable models	EN
		General	
Part name	Flap Cover Change		

First open the flap slightly, now push the flap up from its bottom edge, focusing on only one side. When the flap is freed from this side, repeat the same operation for the other side.

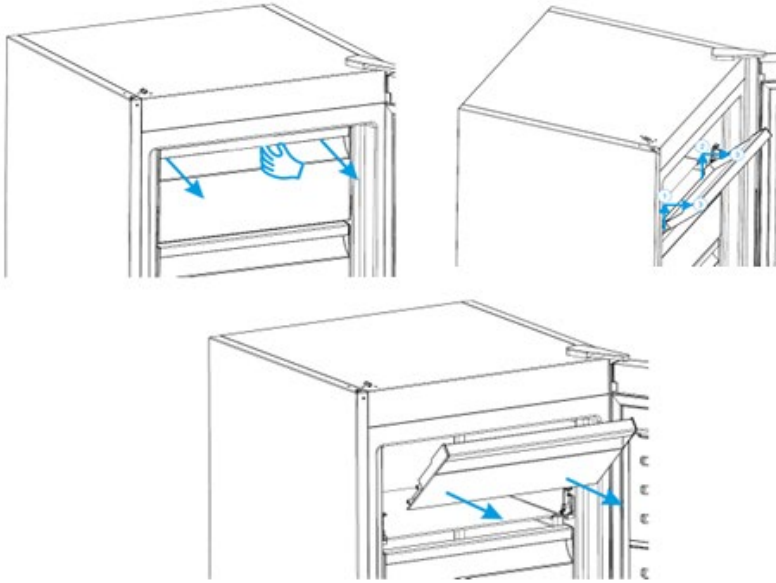

REPLACEMENT PROCEDURE		Applicable models	EN
		General	
Part name	Door Shelf Change		

Gently pull the shelf up using both hands, without bending or twisting the shelf. When shelf is free from assembly on right and left side, you can take the shelf out by pulling towards yourself.

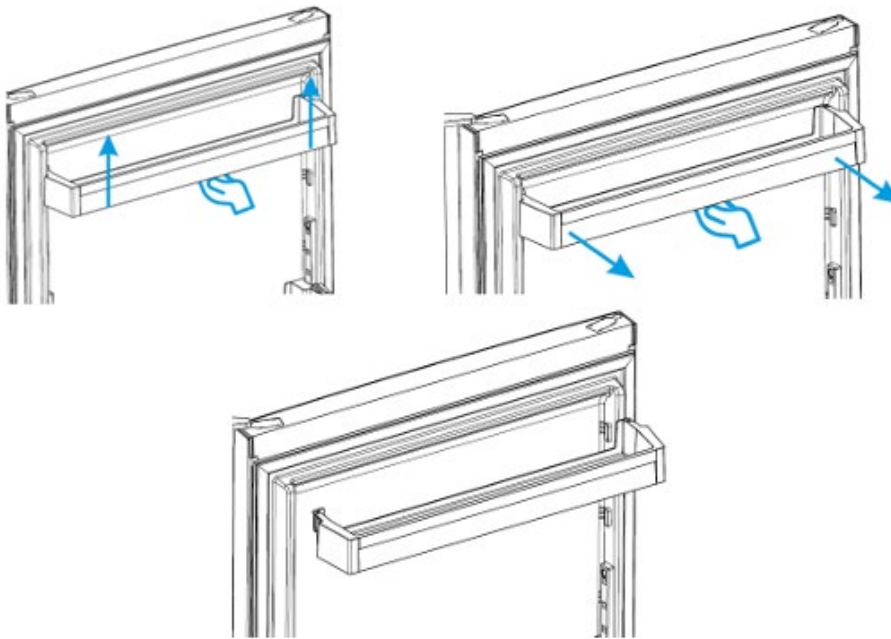

REPLACEMENT PROCEDURE		Applicable models	EN
		General	
Part name	Adjustable Door Shelf Change		

First grip the door shelf by both hands, at the same time using your thumbs, pull latches on sides towards yourself. This will unlock the mechanism, so you can lift the shelf all the way up and free the shelf from its guides on the door.

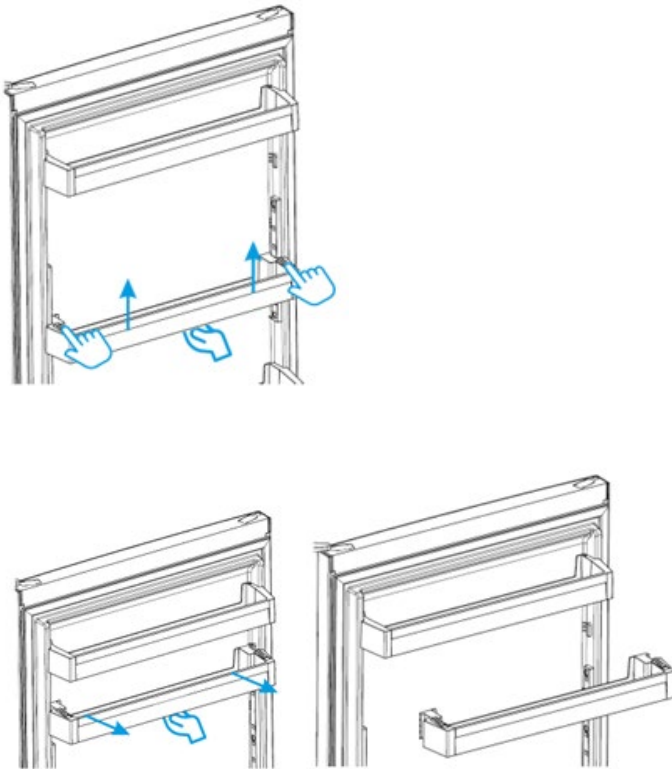

REPLACEMENT PROCEDURE		Applicable models	EN
		General	
Part name	Basket, Chiller, Crisper Change		

First pull the basket out until it reaches end position. Then, gently pull front side up until frees from its guides on the sides. Finally continue pulling it out and remove it from place.

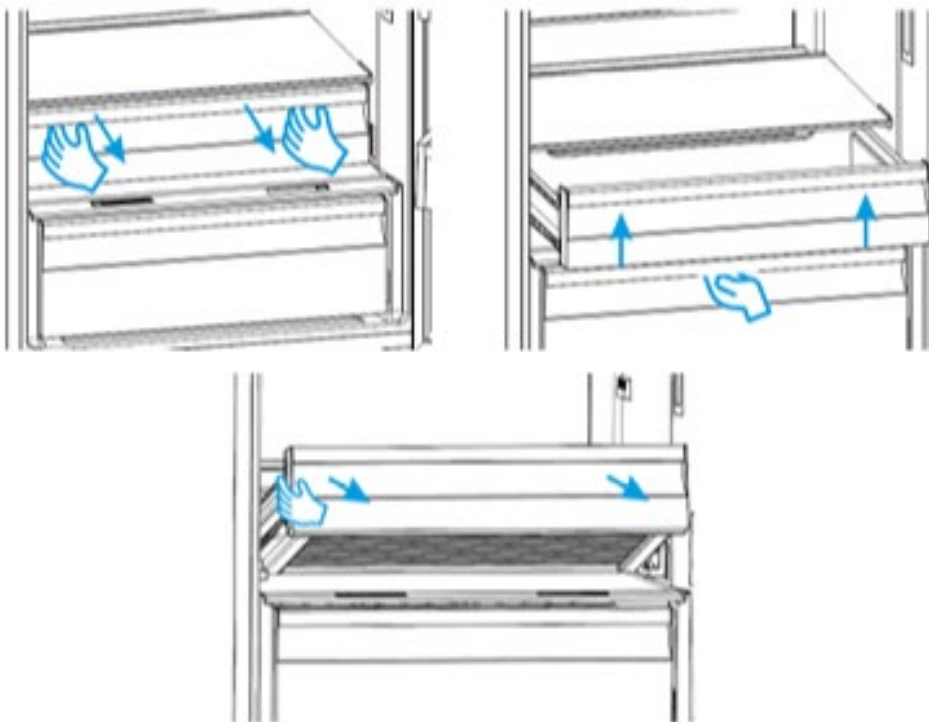

REPLACEMENT PROCEDURE		Applicable models	EN
		General	
Part name	Maxifresh Change		

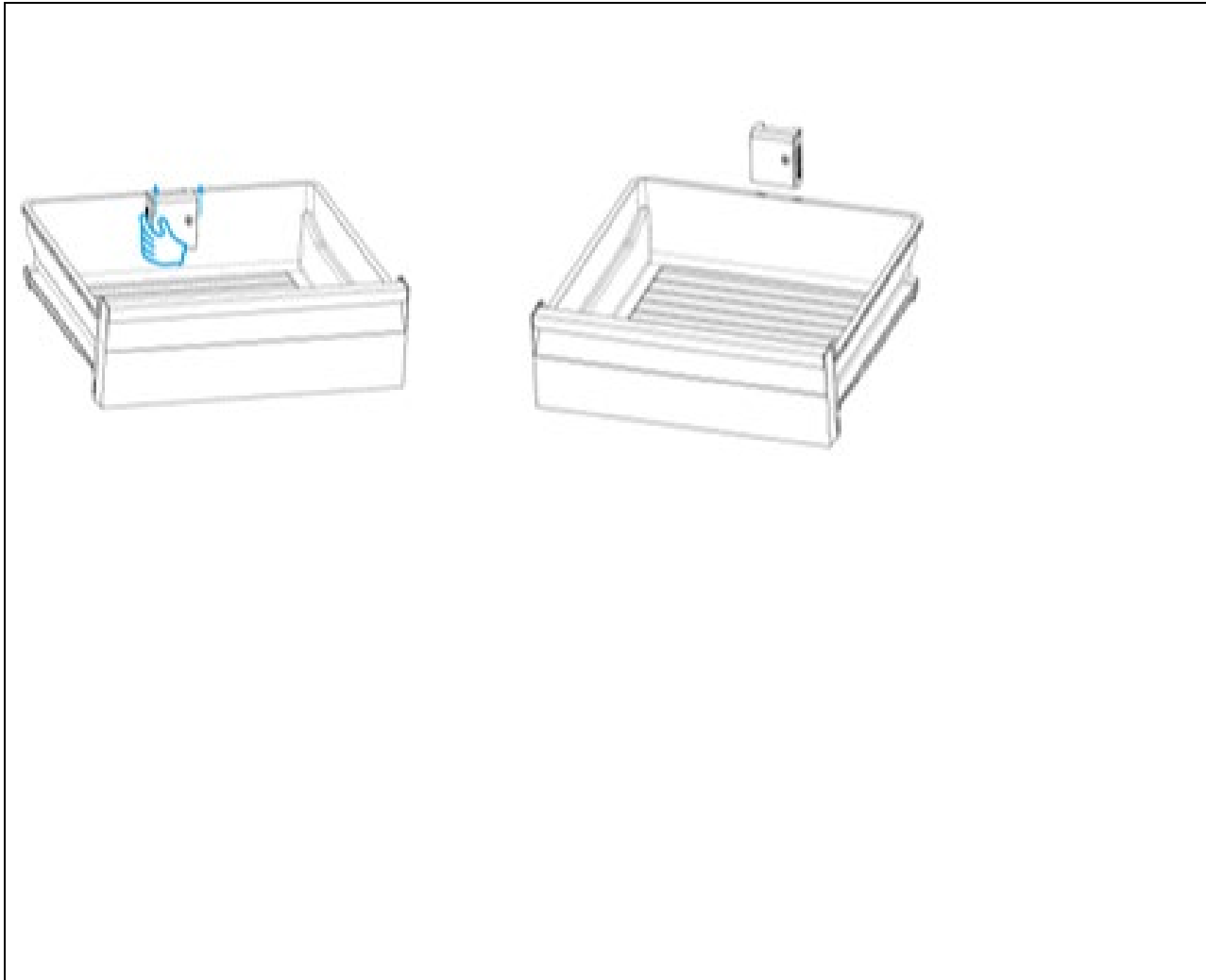

REPLACEMENT PROCEDURE		Applicable models	EN
		General	
Part name	Door Gasket Change		



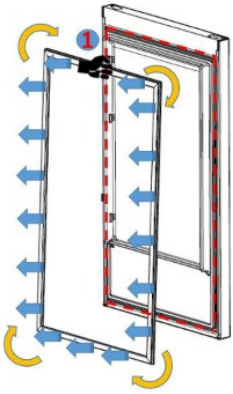



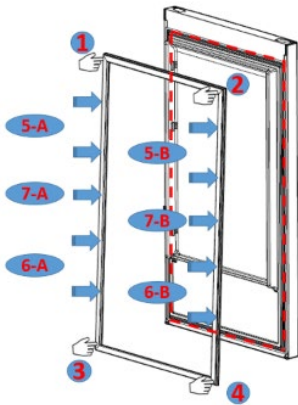

Pull the gasket towards starting from top right corner. Slowly pull the rest of the gasket. Completely remove the gasket from door.











Check the replacement gasket from starting with upper right corner, press on the gasket until it fits to its place. Place the other sides of the gasket with the help of your thumb



After the replacement check if there any nonfitting point on the gasket. Also check if there any opening at the gasket while the door is closed. If so that might cause condensation/icing or insufficient cooling/freezing. To prevent this soften the form of the gasket with the help of a hair dryer or hot water and make sure that all points are closing perfectly.

REPLACEMENT PROCEDURE		Applicable models	EN
		General	
Part name	Reversing the door		
Hold the top hinge cover and remove it toward that direction remove it toward that direction		Unscrew the screws fixing the top hinge and remove it	
			
Displace the top door		Unscrew the two screws fixing the middle hinge and remove it	
			
Displace the bottom door		Unscrew the adjustable foot	
			
Unscrew the bottom hinge screws		Unscrew the bottom hinge pin and screw it to another hole	
			

REPLACEMENT PROCEDURE		Applicable models	EN
		General	
Part name	Reversing the door		
Screw the bottom hinge to the left bottom side of refrigerator. Screw the adjustable foot there		Unscrew the two screws fixing stopper and stopper support plate under the cooler door. After that screw the other side	
			
Replace the top bushing and the top bushing cap at the bottom door.		Remove the support plastic and then metal stopper placed under the upper door. Then re screw these parts to the other side symmetrically. (remember the screw for the metal part must be screwed to the hole which is closer to the bushing). Do not use cordless screwdriver for these screws.	
			
Remove the hinge cover on the top panel and replace to other side		Place the bottom door and rotate the middle hinge by 180°. After that, Screw to the right side on the middle sheet	
			
Place the top door to the middle hinge and screw the top hinge to the top panel		Place the top hinge cover	
			

REPLACEMENT PROCEDURE		Applicable models	EN
		General	
Part name	Water Tank		

Mount the water tank, push it down to firmly secure it in the holder

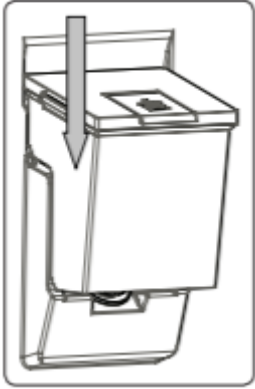

Add your drinks with the help of the water tank top cover

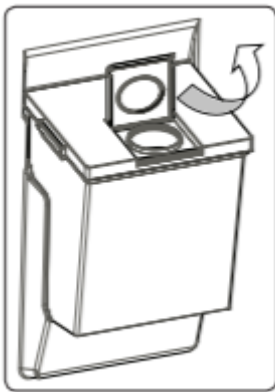

Release the side locking covers to detach the water tank cover.



To serve your drinks, gently press the valve lever

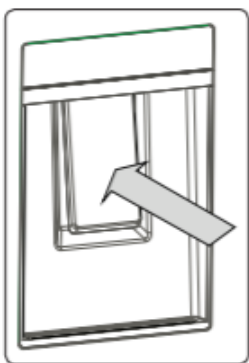

ADDITIONAL SUPPORT	Applicable models	EN
	General	

The following parts are available for the customer to undertake repairs at their own risk. Please carefully follow the guidance given in this manual including all safety measures.

- Door Handles
- Door Hinges
- Trays
- Baskets
- Door Gaskets

Parts can be obtained by calling the support service listed in this section. All repairs in this manual can be achieved using commonly available tools.

If you are in any doubt of your ability to carry out a repair, please use a professional repairer, also available through the support service.

Damage sustained to the appliance or future faults arising from poorly carried out repairs will not be covered under warranty.

Help and assistance

If you require any technical guidance or find that your fridge-freezer is not operating as intended, a simple solution can often be found in the **Troubleshooting** section of these instructions or online at

www.bush-support.com

If you still require further assistance, call one of our experts on **0345 257 7271***. To help us give you a fast and efficient service please have the following information ready.

Model Ref.

Serial number

Date of purchase

You can find these on the rating plate - a small information panel (usually a sticker or metal plate) on the rear of your appliance

This will be shown on your receipt

Local call rates apply*

Lines open 8am-7pm Monday to Saturday an 10am-4pm Sunday.

*Calls to Bush enquiry lines may attract a charge and set up fee residential lines depending on your call plan/tariff. Mobile and other providers costs may vary, see www.bt.com/pricing for details

For security and training purposes, telephone calls to and from customer service centres maybe recorded and monitored. Calls from Republic of Ireland will attract international call charges

Notes on disposal :



The symbol on the product or its packaging indicates that this product may not be treated as household waste. Instead it should be handed over to the applicable collection point for the recycling of electrical and electronic equipment. By ensuring this product is disposed of correctly, you will help prevent potential negative consequences for the environment and human health, which could otherwise be caused by inappropriate waste handling of this product. For more detailed information about recycling this product, please contact your local council office, your household waste disposal service or the shop where the product was purchased.