

Service Manual

CHEST FREEZER SERIES

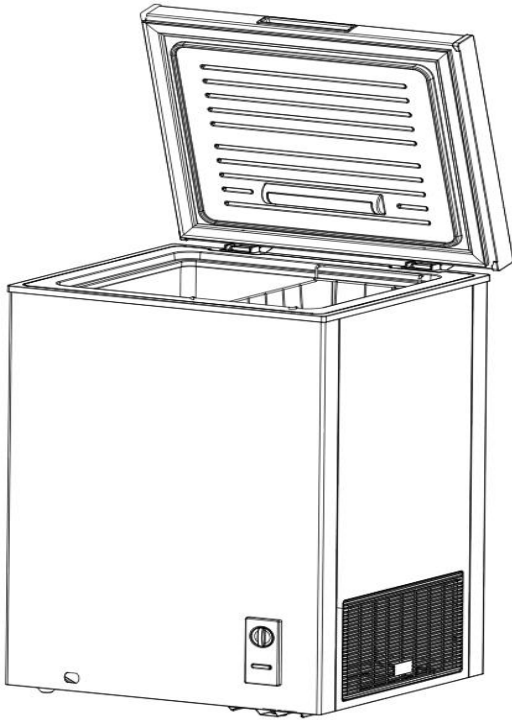

Applicable Models	Model Code
CE-BD199-ST	<u>22032010003501</u>

Prepared by	R&D:GaoHongBing
Reviewed by	QA:WuXinbin SVC:Liu Jicheng
Approved by	R&D:ZhangHuawei SVC:GuangTaoshuai

(The picture in this service manual is only for reference, and specific appearance and configuration are subject to the real product)

 **WARNING**

Important Safety Notice

There are special components used in this equipment which are important for safety. These parts are marked by  in the Schematic Diagrams, Circuit Board Diagrams, Exploded Views and Replacement Parts List. It is essential that these critical parts should be replaced with manufacturer's specified parts to prevent shock, fire or other hazards. Do not modify the original design without permission of manufacturer.

 **WARNING**

Important Safety Notice

The Maintenance Manual is only for the use of maintenance personnel with certain experience and background in electrical, electronic and mechanical field.





Any attempt to repair main devices may lead to personal injury and property loss.

Manufacturers or distributors are not responsible for the content of the Manual and interpretation thereof.

1. Safety Warning Code

1.1 Warning for operation safety

Important Safety Instructions

	CAUTION RISK OF ELECTRIC SHOCK DO NOT OPEN	
	This symbol indicates that dangerous voltage constituting a risk of electric shock is present within your freezer.	
	This symbol indicates that there are important operating and maintenance instructions in the literature accompanying your freezer.	

WARNING

- 1) Read these instructions.
- 2) Keep these instructions.
- 3) Heed all warnings.
- 4) Follow all instructions.
- 5) Do not use this appliance near water.
- 6) Clean only with a damp cloth.
- 7) Do not block any ventilation openings.
- 8) Install in accordance with the manufacturer's instructions.
- 9) Do not install near any heat sources, such as radiators, heat registers, stoves, or other apparatus that produce heat.
- 10) Do not defeat the safety purpose of the polarized or grounding-type plug. A polarized plug has two blades with one wider than the other. A grounding type plug has two blades and a third grounding prong. The wide blade or the third prong are provided for your safety. If the provided plug does not fit into your outlet, consult an electrician for replacement of the obsolete outlet.
- 11) Protect the power cord from being walked on or pinched, particularly at plugs, convenience receptacles, and the point where they exit from the appliance.
- 12) Do not attempt to modify or extend the power cord of this appliance.
- 13) Unplug this appliance during lightning storms or when it will not be used for long periods of time.
- 14) Make sure that the available AC power matches the voltage requirements of this appliance.

CONNECTING ELECTRICITY

**WARNING****Electrical Shock Hazard.**

Plug into a grounded 3-prong outlet.
Do not remove the ground prong.
Do not use an adapter.

Failure to follow these instructions can result in death, fire, or electrical shock.

**WARNING****Electric Shock Hazard**

Failure to follow these instructions can result in electric shock, fire, or death.

- 1) **WARNING**—Keep ventilation openings, in both the freezer and the built-in structure, clear of obstruction.
- 2) **WARNING**—Do not touch the interior of the freezer with wet hands. This could result in frost bite.
- 3) **WARNING**—Do not use mechanical devices or other means to accelerate the defrosting process, other than those recommended by the manufacturer.
- 4) **WARNING**—Do not damage the refrigerant circuit.
- 5) **WARNING**—Do not damage the refrigerant tubing when handling, moving, or using the freezer.
- 6) **WARNING—DANGER**—Never allow children to play with, operate, or crawl inside the freezer. Risk of child entrapment. Before you throw away your old freezer:
 - 6-1) Take off the doors
 - 6-2) Leave the shelves in place so that children may not easily climb inside
- 7) Unplug the freezer before carrying out user maintenance on it.
- 8) This freezer can be used by children age eight years and older and persons with reduced physical or mental capabilities or lack of experience and knowledge if they are given supervision or instruction concerning the use of the freezer in a safe way and understand the hazards involved. Children should not play with the freezer. Cleaning and maintenance should not be performed by children without supervision.
- 9) If a component part is damaged, it must be replaced by the manufacturer, its service agent, or similar qualified persons in order to avoid a hazard.
- 10) Please dispose of the freezer according to local regulations as the freezer contains flammable gas and refrigerant.
- 11) Follow local regulations regarding disposal of the freezer due to flammable refrigerant and gas. All refrigeration products contain refrigerants, which under the guidelines of federal law must be removed before disposal. It is the consumer's responsibility to comply with federal and local regulations when disposing of this product.
- 12) This freezer is intended to be used in household and similar environments.

13) Do not store or use gasoline or any flammable liquids inside or in the vicinity of this freezer.

14) Do not use extension cords or ungrounded (two-prong) adapters with this freezer. If the power cord is too short, have a qualified electrician install an outlet near the freezer. Use of an extension cord can negatively affect the freezer's performance.

Grounding requirement

This freezer must be grounded. This freezer is equipped with a cord having a grounding wire with a grounding plug. The plug must be inserted into an outlet that is properly installed and grounded.

Improper use of the grounding plug can result in a risk of electric shock. Consult a qualified electrician or service person if the grounding instructions are not completely understood, or if doubt exists as to whether the freezer is properly grounded.

1.2 Safety instruction for refrigerant

 **WARNING**



Explosion Hazard.

Keep flammable materials and vapors, such as gasoline, away from freezer. Failure to do so can result in fire, explosion, or death.



Safety instruction for refrigerant

DANGER—Risk of Fire or Explosion. Flammable Refrigerant Used. To Be Repaired Only By Trained Service Personnel. Do Not Use Mechanical Devices. Do Not Puncture Refrigerant Tubing. CAUTION—Risk of Fire or Explosion. Flammable Refrigerant Used. Consult Repair Manual/Owner's Guide Before Attempting To Service This Product. All Safety Precautions Must be Followed. CAUTION—Risk of Fire or Explosion. Dispose of Properly In Accordance With Federal Or Local Regulations. Flammable Refrigerant Used. CAUTION—Risk of Fire or Explosion Due To Puncture Of Refrigerant Tubing; Follow Handling Instructions Carefully. Flammable Refrigerant Used.

2. Description for product features

This product is provided with following features:

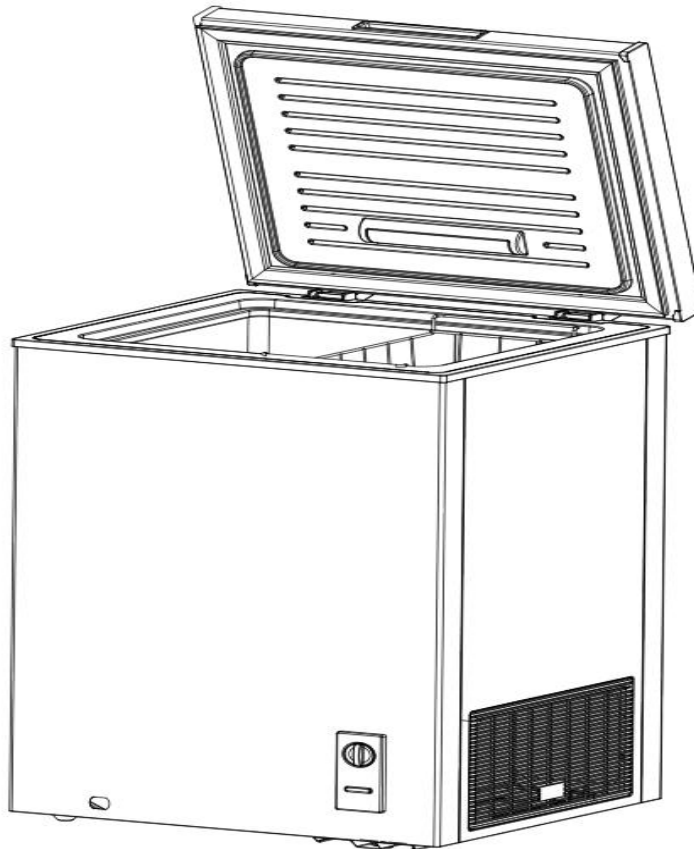

- 1) Square temperature control panel
- 2) top single opening design

3. Installation and commissioning

3.1 Handling

Handling

1)Protect the refrigerator in moving it,Same as shown as left photo, please move it by handcart with cushion
 2)Remove all packing materials and bottom cushion, then move into house for placement
 3)After moving it to appropriate location, wait for 2 hours before power on.

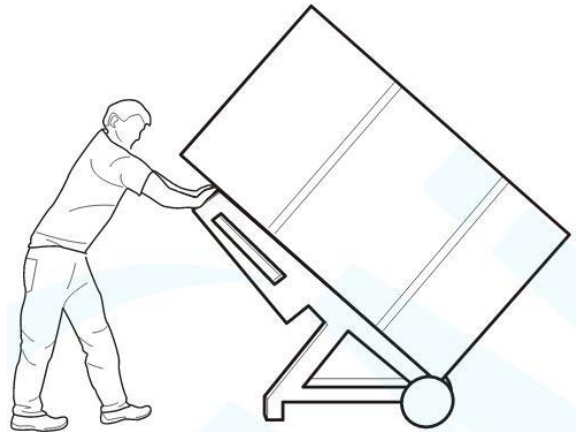

3.2 Door Disassembly and Assembly

The refrigerator door needs to be dismantled if it cannot enter the room in the whole.

Disassembly of Freezer door

Disassembly of Freezer door	None
-----------------------------	------

Disassembly of refrigerator door

Disassembly of refrigerator door	None
----------------------------------	------

3.3 Installation location

Installation location

Location that is easy for ventilation shall be chosen to facilitate heat dissipation, enhance its performance and reduce the energy consumption.

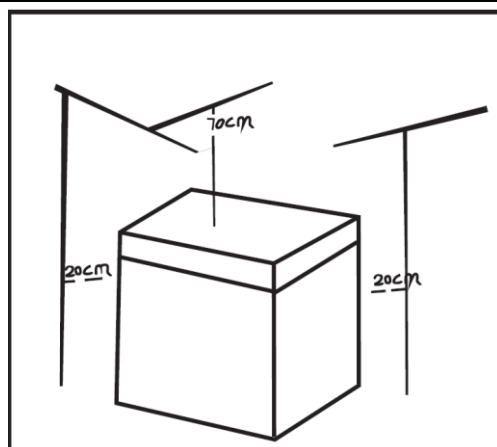

3.4 Leveling of the refrigerator

Leveling of the refrigerator

If the refrigerator cannot be placed steadily, adjust the footing to level it.

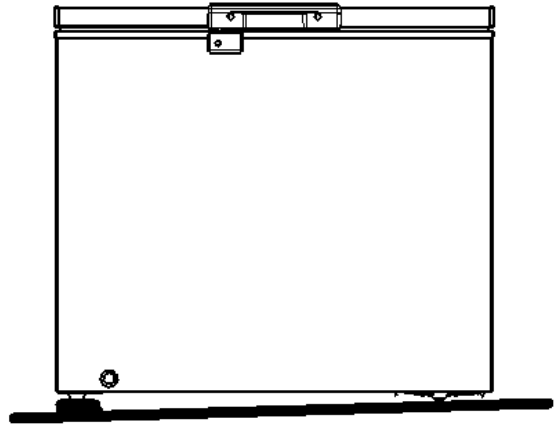

3.5 Door reversal(None)

Door reversal

Door reversal	None
---------------	------

3.6 Installation of handle(None)

Installation of handle

Installation of handle	None
------------------------	------

3.7 Installation of door lock(None)

Installation of door lock

Installation of door lock	None
---------------------------	------

3.8 Adjustment to level the door(None)

Adjustment to level the door

Adjustment to level the door	None
------------------------------	------

3.9 Adjustment to shelves(None)

Adjustment to shelves

Adjustment to shelves	None
-----------------------	------

4. Terms

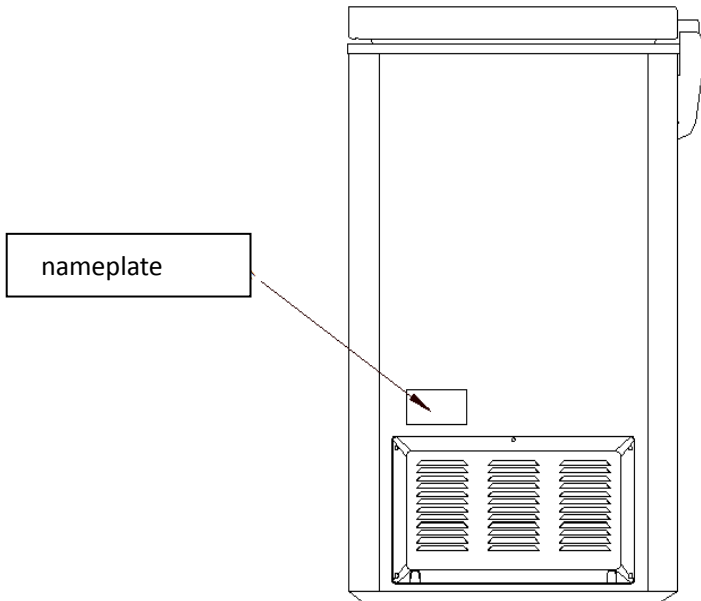

4.1 Definition of model (None)

4.2 Location of nameplate(Non)

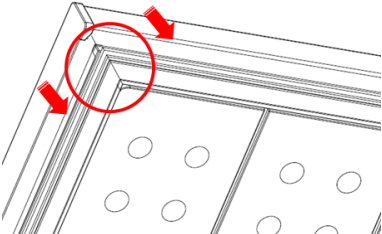
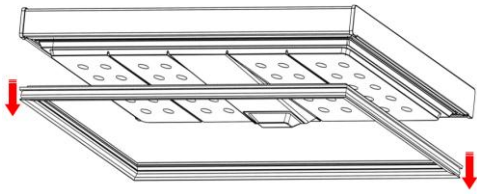
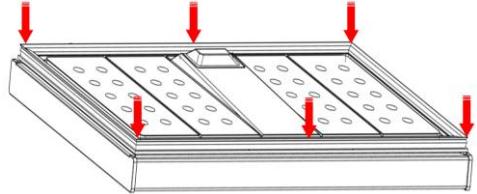

8. Dismantling of parts

8.1 Parts on the door

Door seal	
<p>1) Pull the door seal from the corner</p>	
<p>2) Take efforts until door seal totally detaches from door inner liner groove, remove the door seal</p>	
<p>3) Fixing the four corners and pressing smoothly.</p>	
The hinge cover	
<p>1) Open the upper hinge of the lower hinge cover by hand to a certain angle until the hinge cover is separated from the certain distance.</p>	
<p>2) Pull down the lower hinge cover.</p>	

3) Open the slanted upward of hinge cover to a certain angle by a screwdriver and remove the hinge cover. Wear safety gloves for fear of cutting the hand.



1) When the door is closed, open the lower hinge cover along the side wall to a suitable angle and push forwards into the side wall of the hinge until the hinge cover boss completely falls into the hinge hole.



2) Hold the side of upper hinge cover with both hands, align the opening with the side wall of the hinge, and push down until the hinge cover protrusion completely falls into the hinge hole. Then the upper and lower hinge covers are all in place.



Door light disassembly and assembly

Door light disassembly and assembly

None

8.2 Parts inside the refrigerator

Basket

Open the door and removed the basket

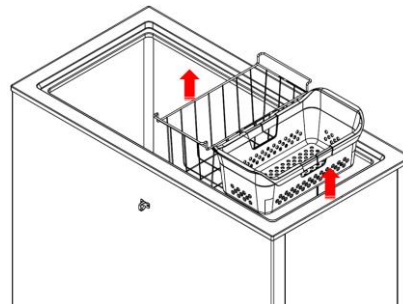

Inside water pipe cover

Counterclockwise to remove the pipe cover

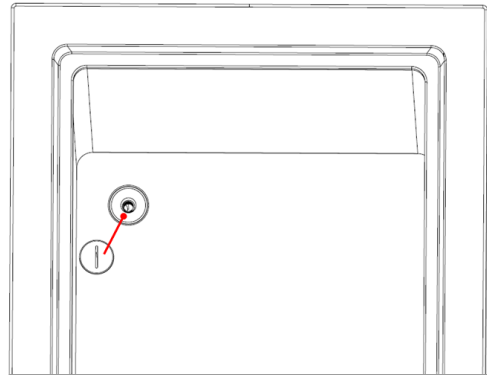

Ice tray

Ice tray

None

--	--