

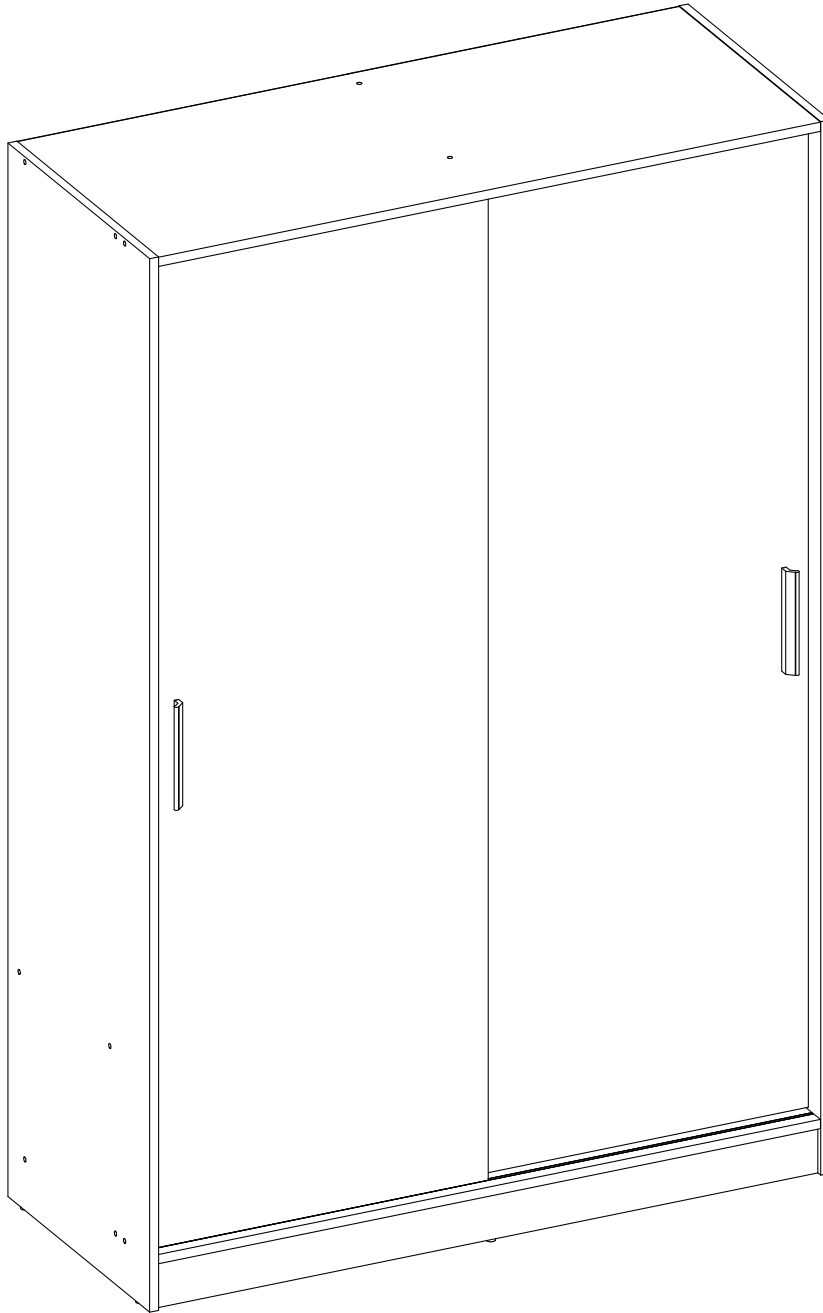

NOVA SLIDER



Spare Parts

 www.argos-support.co.uk

 Help@ClickSpares.co.uk

 0370 112 1928

Customer Support

 0345 640 2020



Safety and Care Advice

IMPORTANT, RETAIN FOR FUTURE REFERENCE: READ CAREFULLY.

- Keep children and animals away from the work area, small parts could choke if swallowed.
- Assemble the item as close to its final position (in the same room) as possible.
- Assemble on a soft level surface to avoid damaging the unit or your floor.
- We do not recommend the use of power drill/drivers for inserting screws as this could damage the unit. Only use hand screwdrivers.
- Parts of the assembly will be easier with 2 people.
- Dispose of all packaging carefully and responsibly.

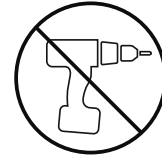

Care and maintenance

- Only clean using a damp cloth and mild detergent. Do not use abrasive cleaners.
- From time to time check that there are no loose screws, nuts or bolts. If there are please re-tighten.
- This product should not be discarded with household waste. Take to your local authority waste disposal centre.
- Use a dry cloth to clean the product, furniture polish is not recommended.

Fittings (Shown to scale)

Wardrobe

WARNING!

IN ORDER TO PREVENT OVERTURNING
THIS PRODUCT MUST BE USED WITH
THE WALL ATTACHMENT DEVICE
PROVIDED

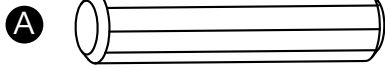

A 8x35 Wooden Dowel x26

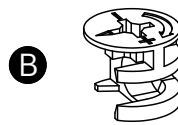

B Locking Cam x2



C 16mm Screw x2

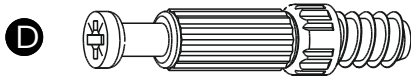

D Metal Dowel x2

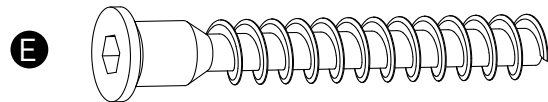

E 50 mm Assembly Bolt x22



F 13mm Screw x12

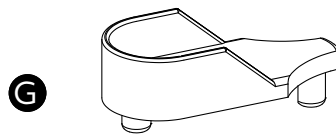

G Hanging Rail Support x4



H Cam cover x2

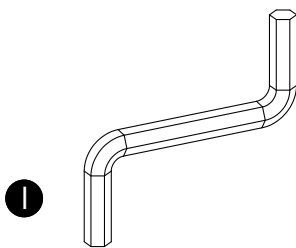

I Key x1

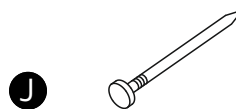

J Nails x84

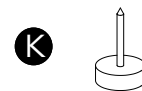

K Foot x5



L 27mm Screw x4



M Back Support x10



N Assembly Bolt Cap x18

Hardware

Wardrobe

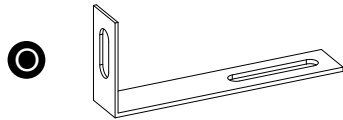

Wall Fixing Bracket x 2



Hanging Rail x 2

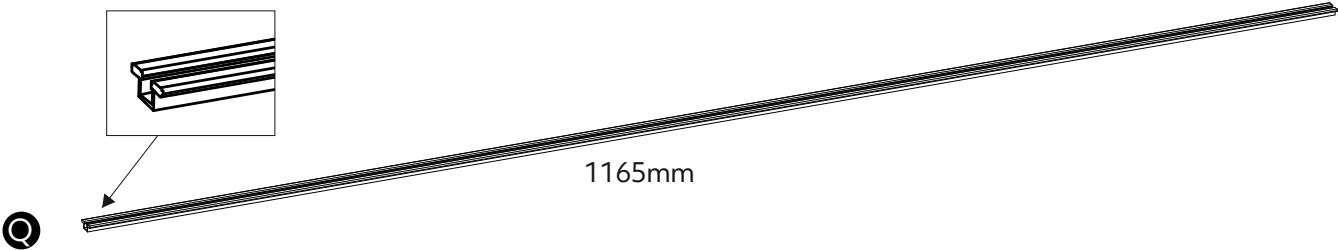

Slider Track x 4

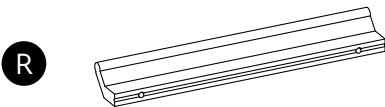

Handle x 2

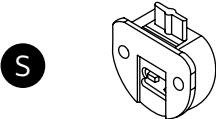

Top Door Bracket x 4

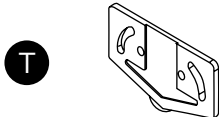

Bottom Door Guide x 4

Tools required

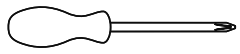

Phillips screwdriver
(small & medium)

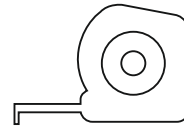

Ruler/tape
measure

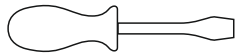

Flat screwdriver
(small & medium)

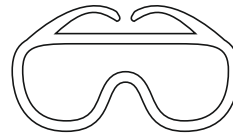

Eye protection
(when using a
hammer or glue)

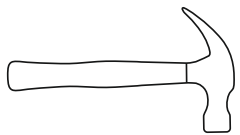

Hammer



Pencil



Set Square

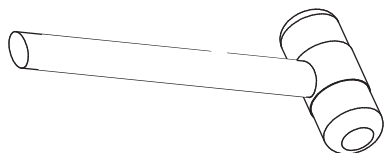

Rubber Hammer

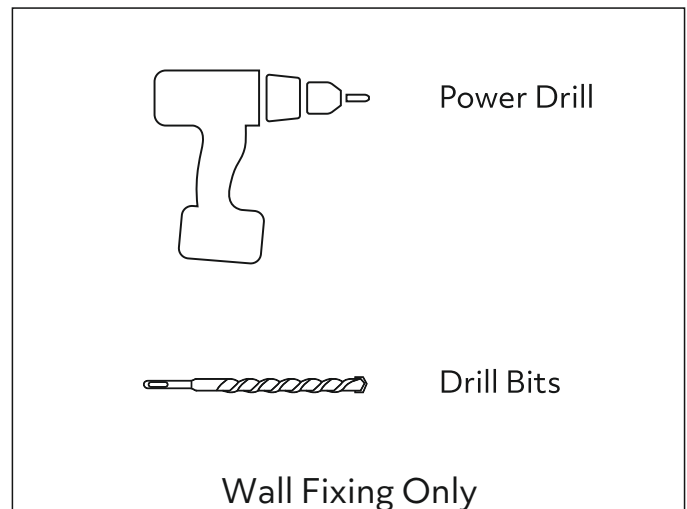

Spirit Level

Panels Frame



1 Left Side Panel
(1820 x 500mm)



2 Right Side Panel
(1820 x 500mm)

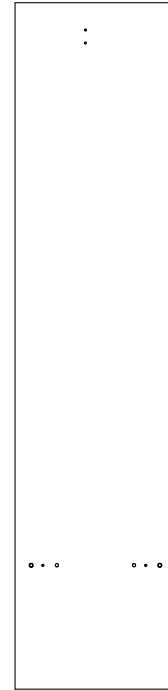

3 Vertical Partition Panel
(1707 x 400mm)

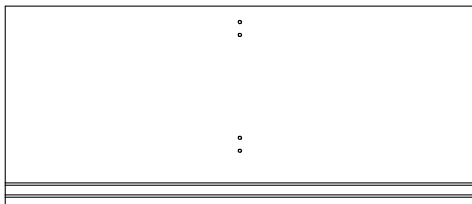

4 Top Panel (1168 x 499mm)

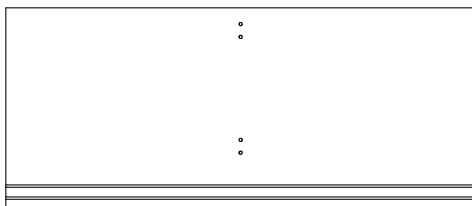

5 Bottom Panel (1168 x 499mm)

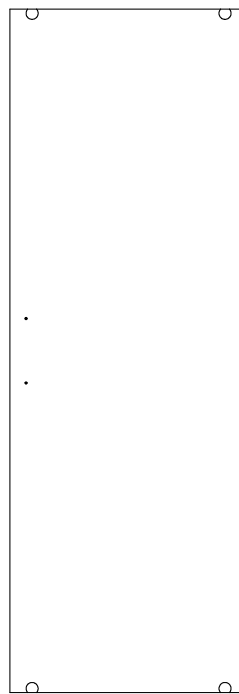

9 Door
(1699 x 590mm) **x2**

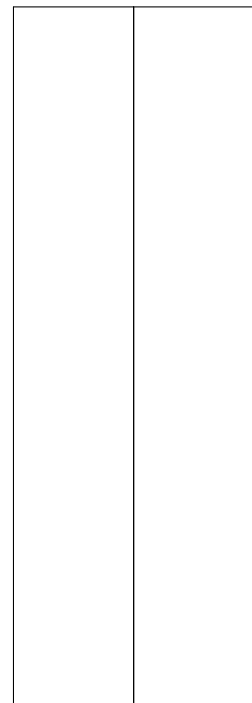

10 Back Panel
(1737 x 598mm) **x2**



6 Horizontal Shelf
Panel Left
(576 x 399mm)



7 Horizontal Shelf
Panel Right
(576 x 399mm)

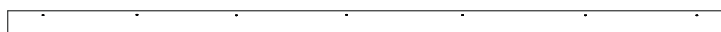

8 Plinth (1168 x 80mm)

Wardrobe

WARNING!

IN ORDER TO PREVENT OVERTURNING
THIS PRODUCT MUST BE USED WITH
THE WALL ATTACHMENT DEVICE
PROVIDED

1

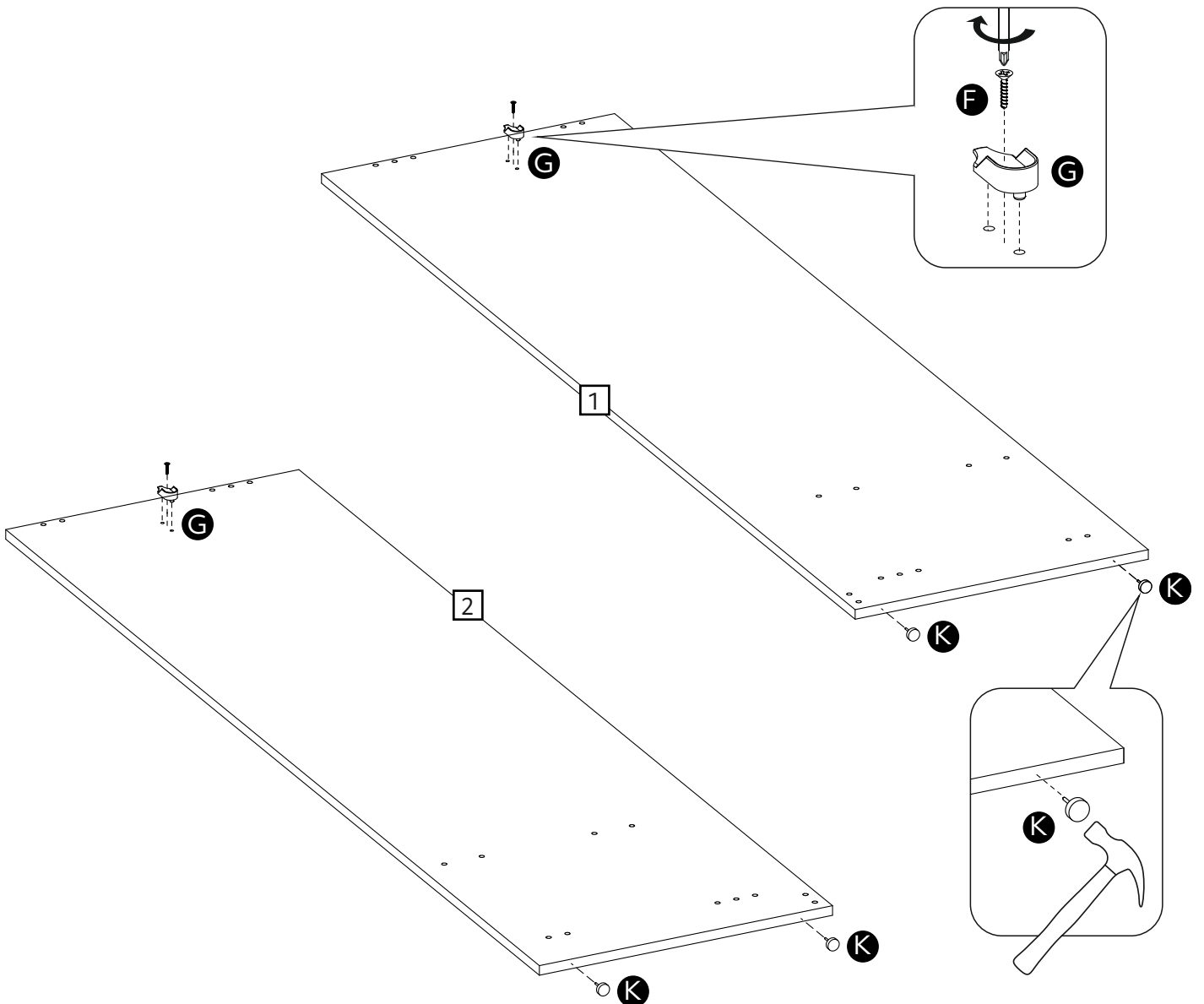
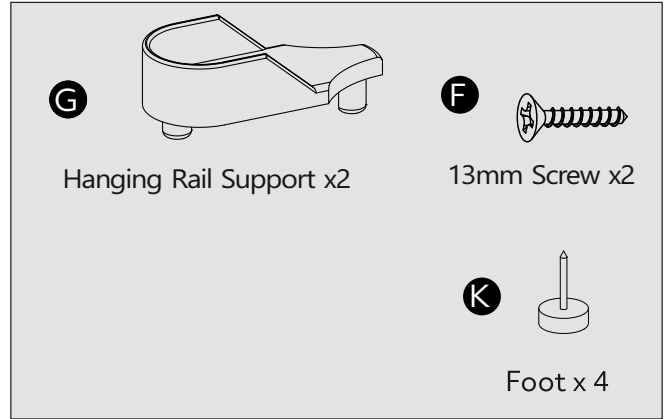
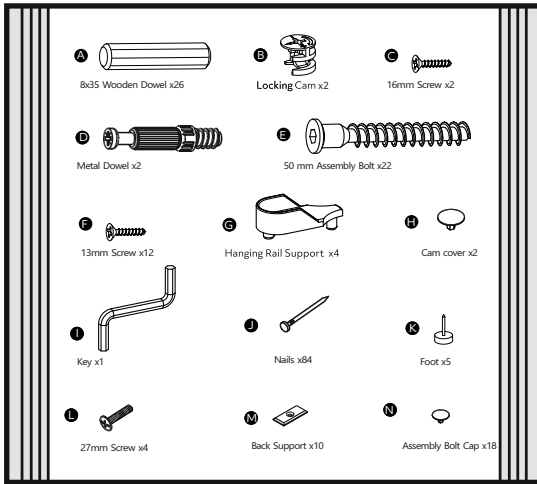

2

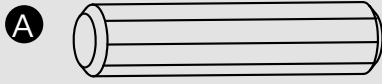

8x35 Wooden Dowel x10

G

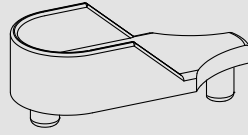

Hanging Rail Support x1

F



13mm Screw x1

K



Foot x1

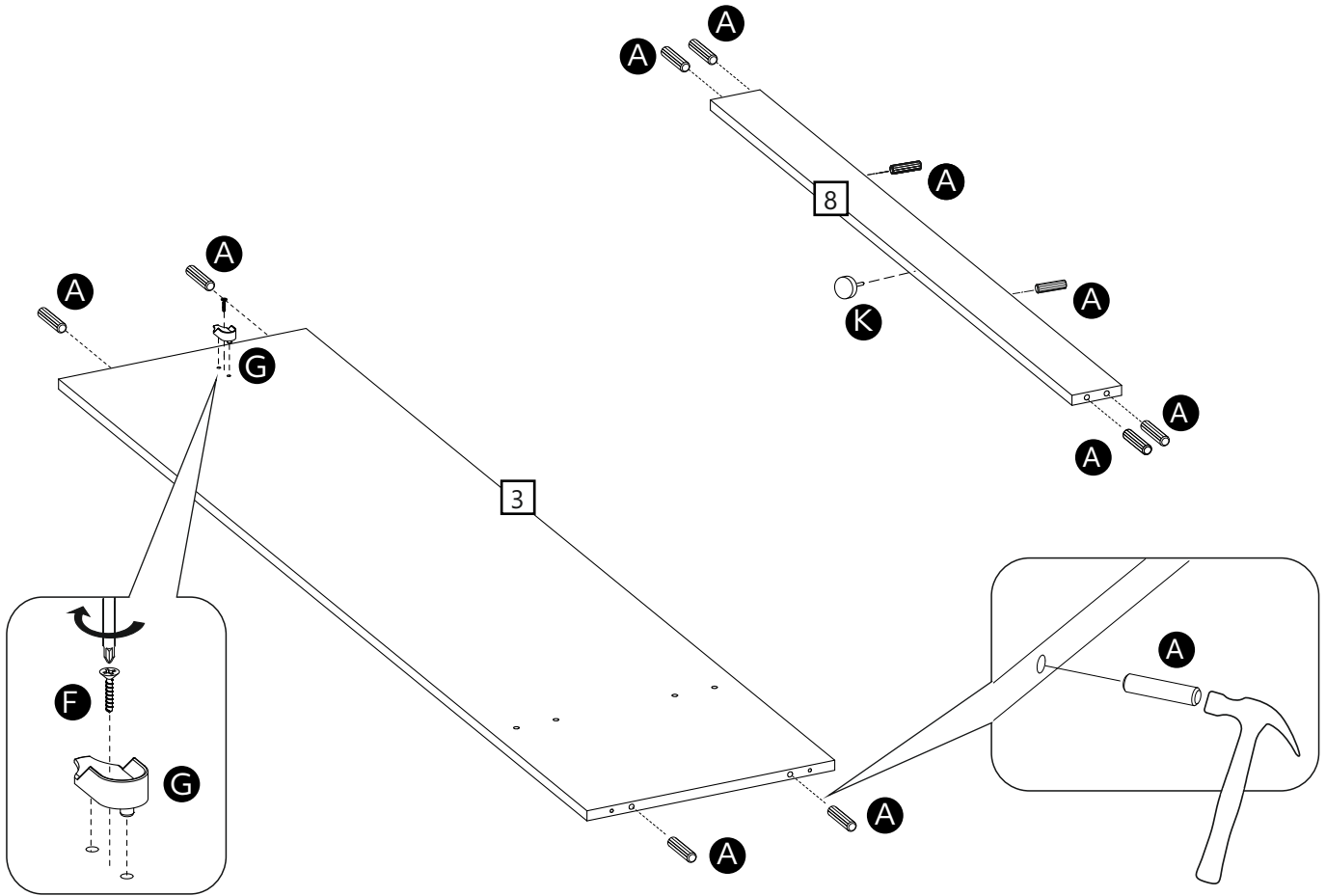

3

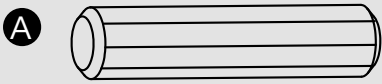

8x35 Wooden Dowel x8

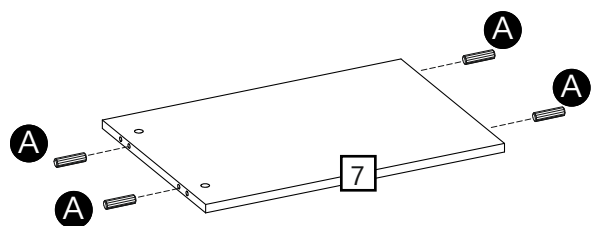
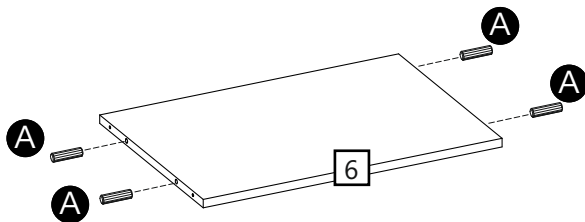

4

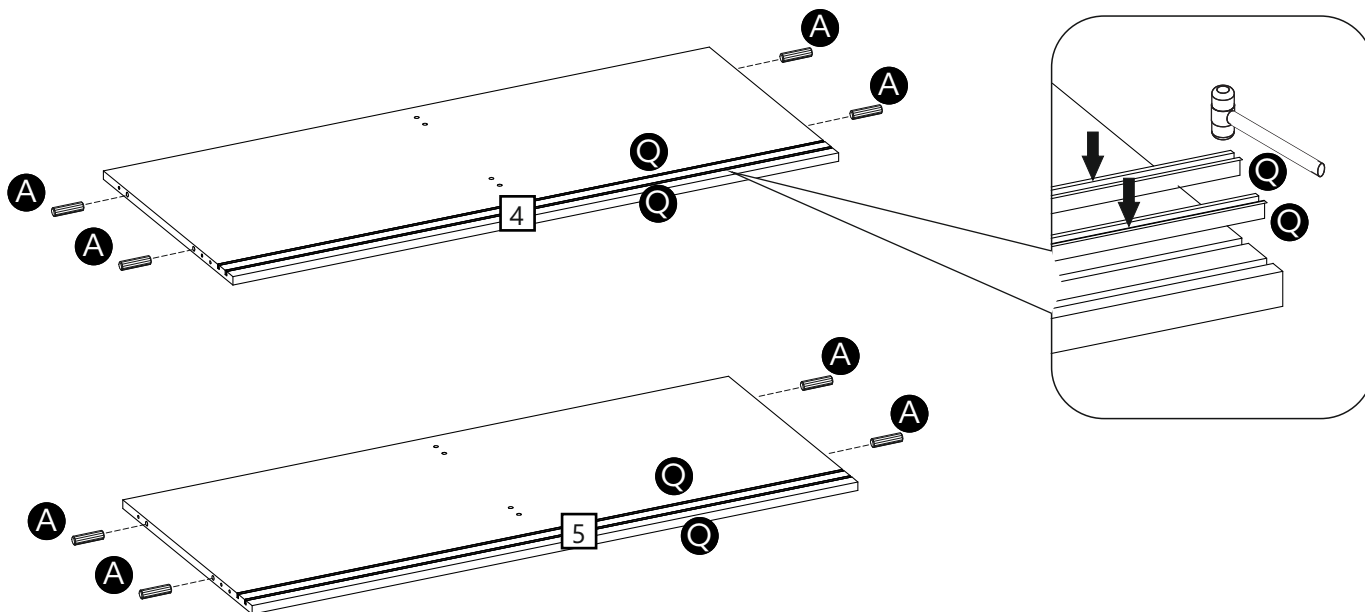
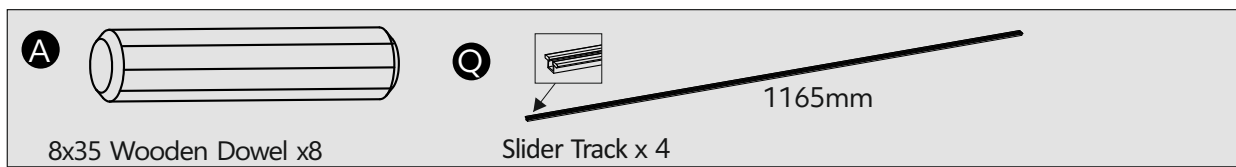

5

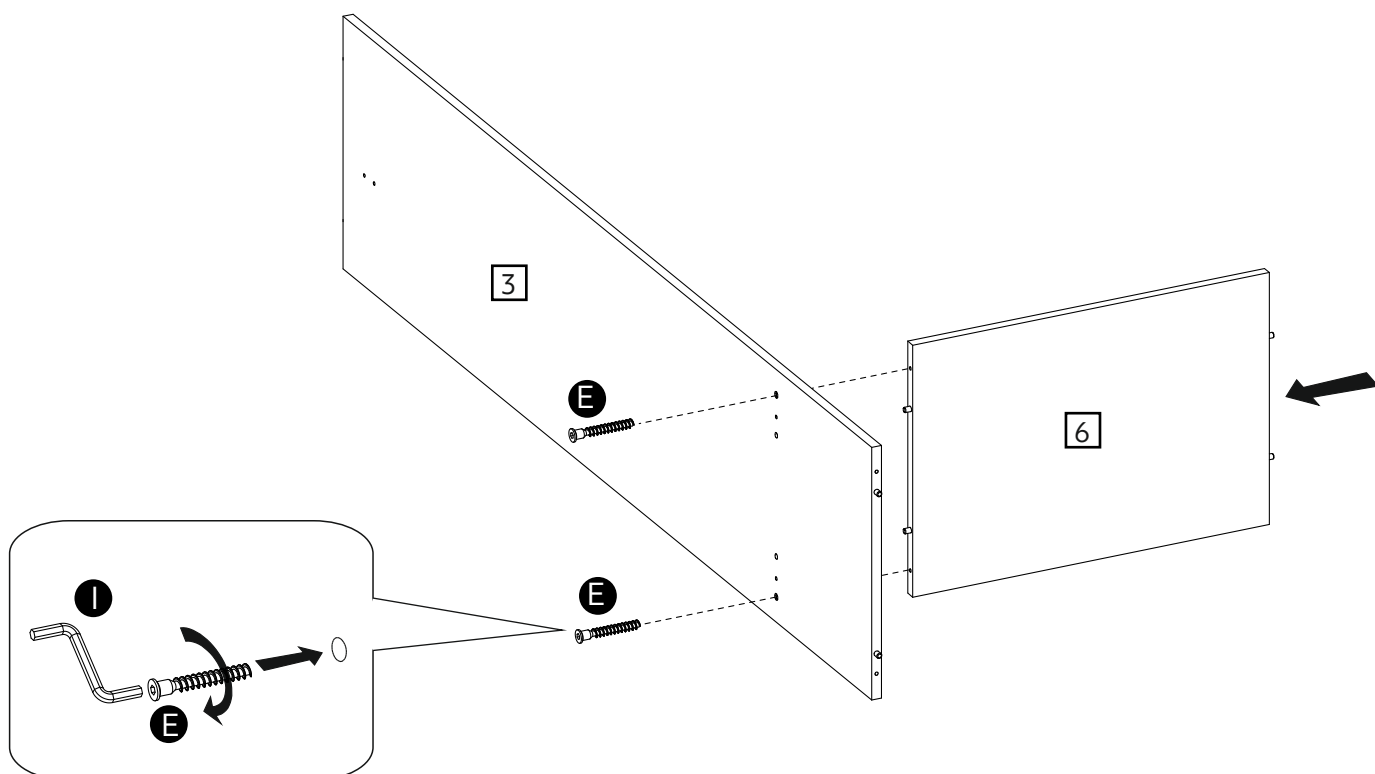
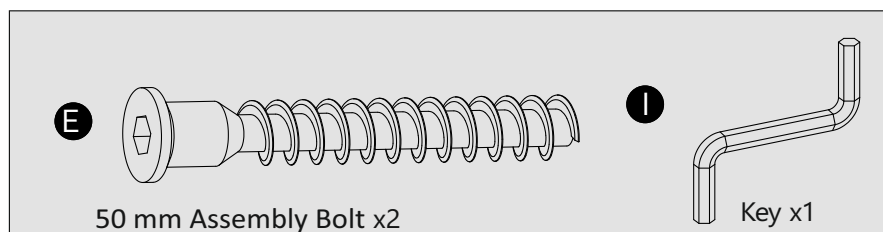

6

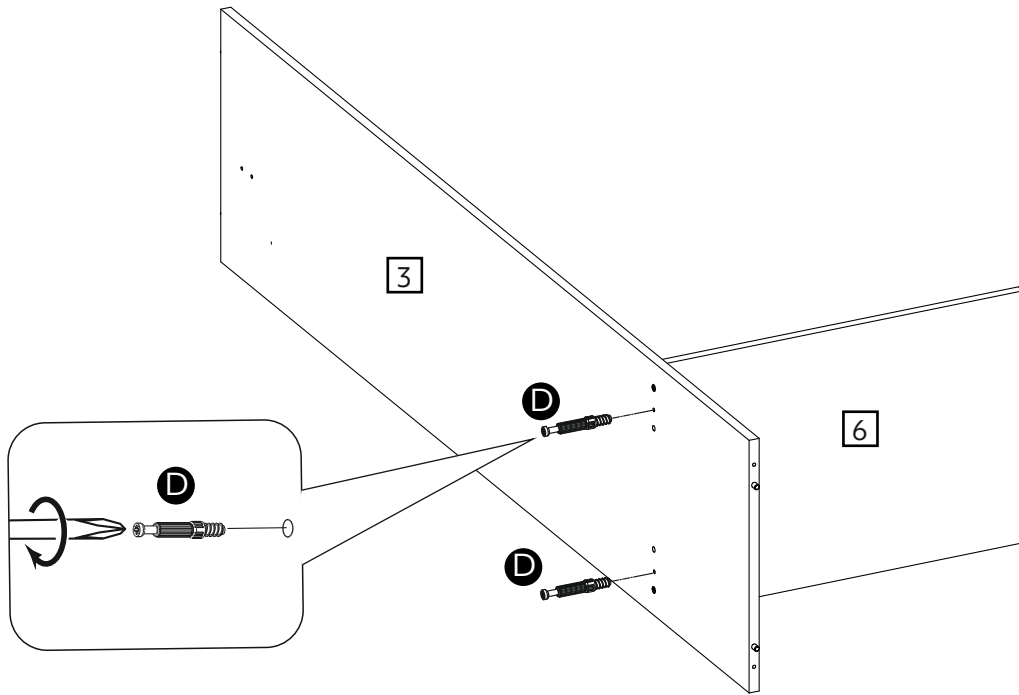
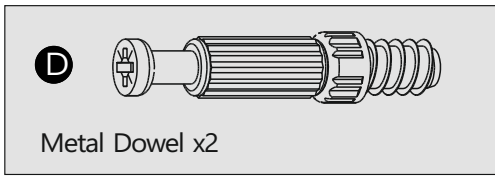

7

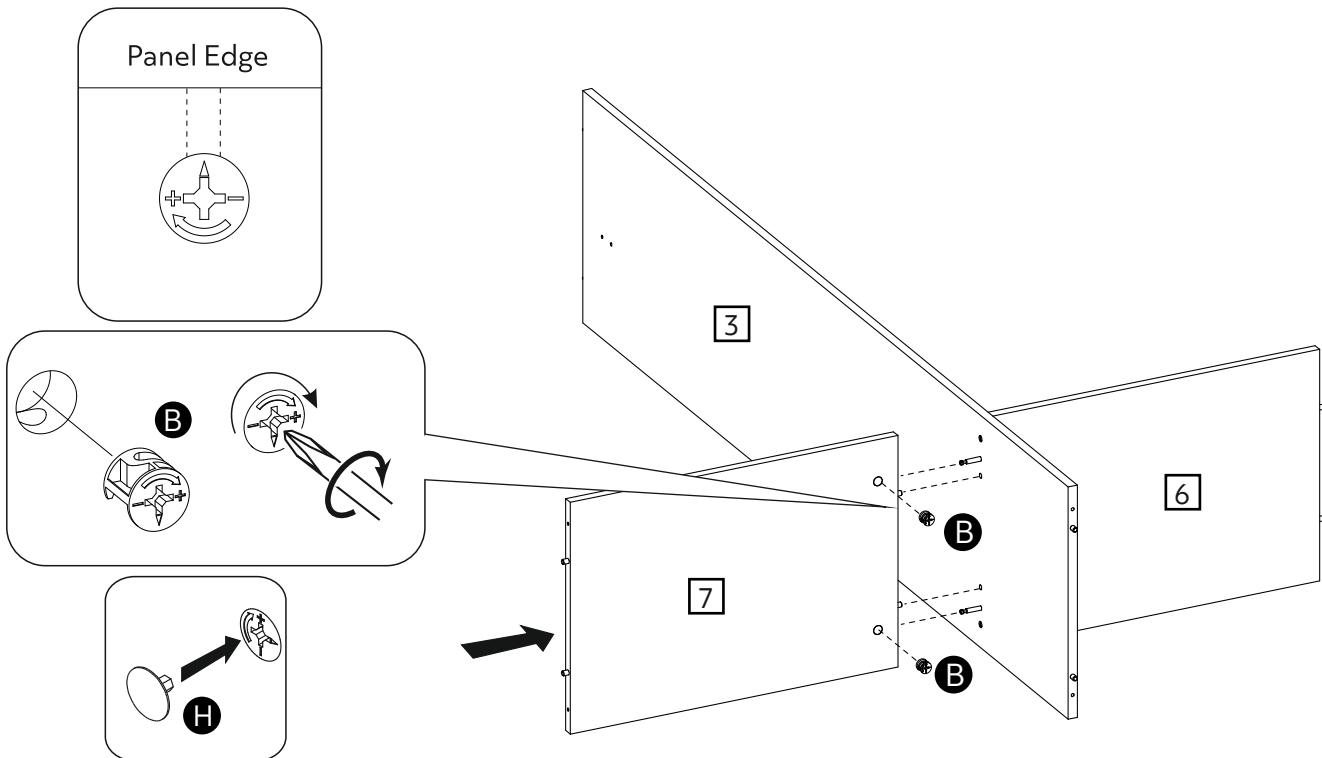
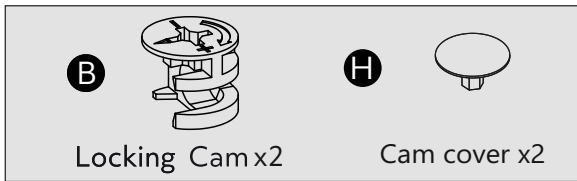

8

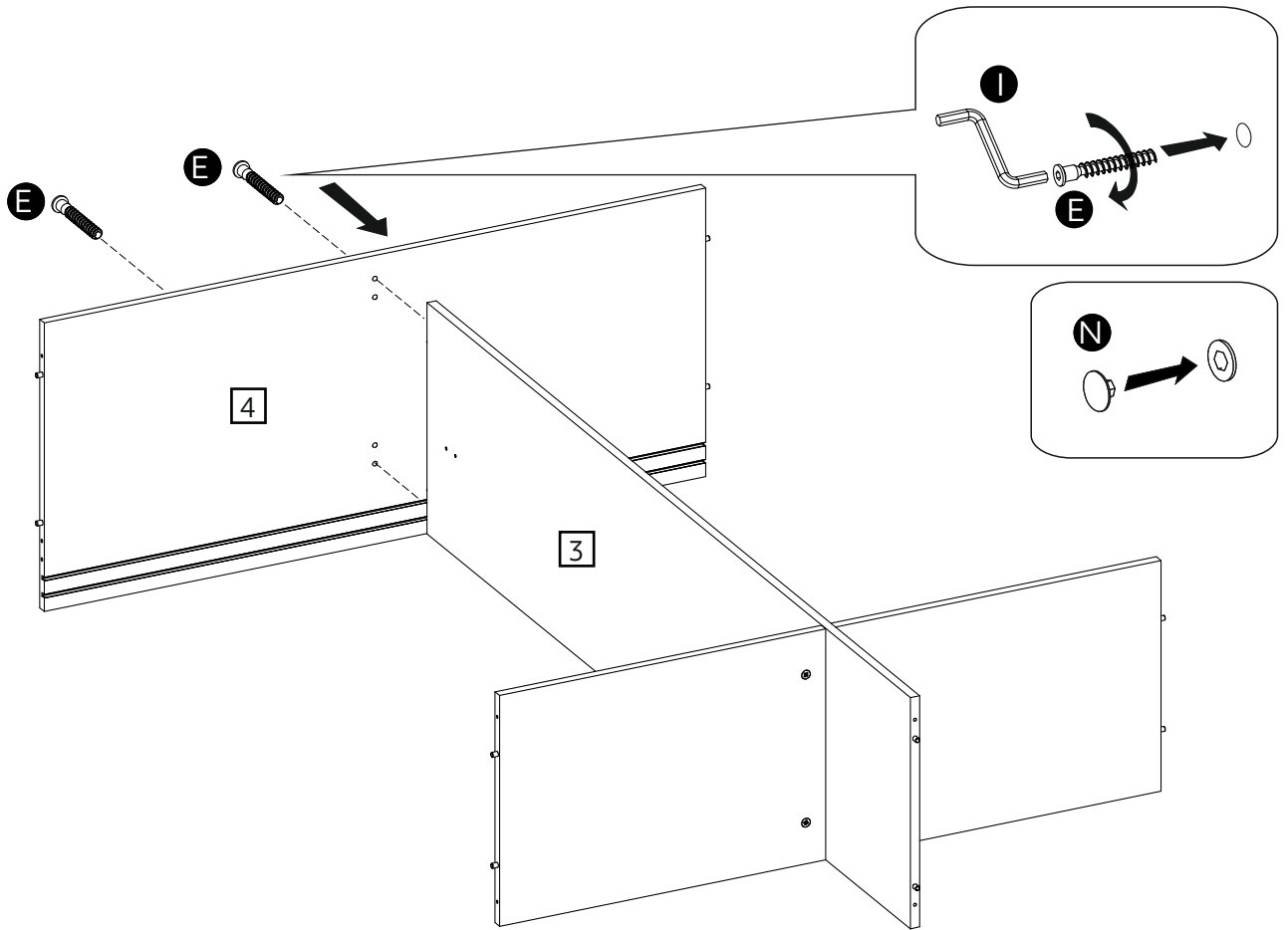
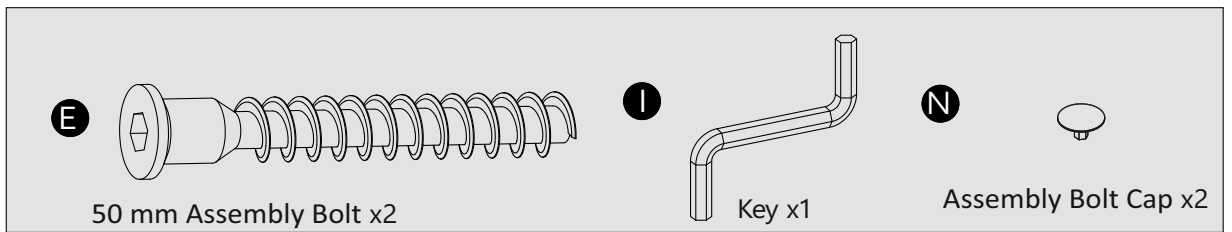

9

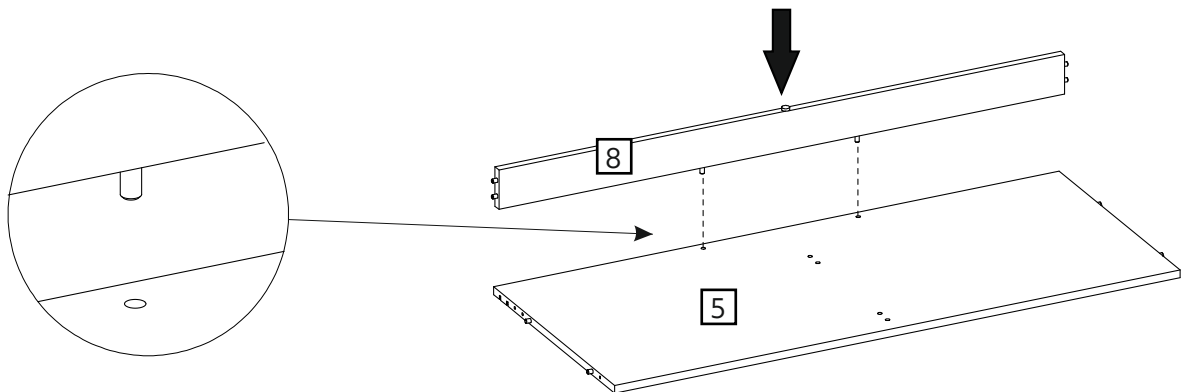

10

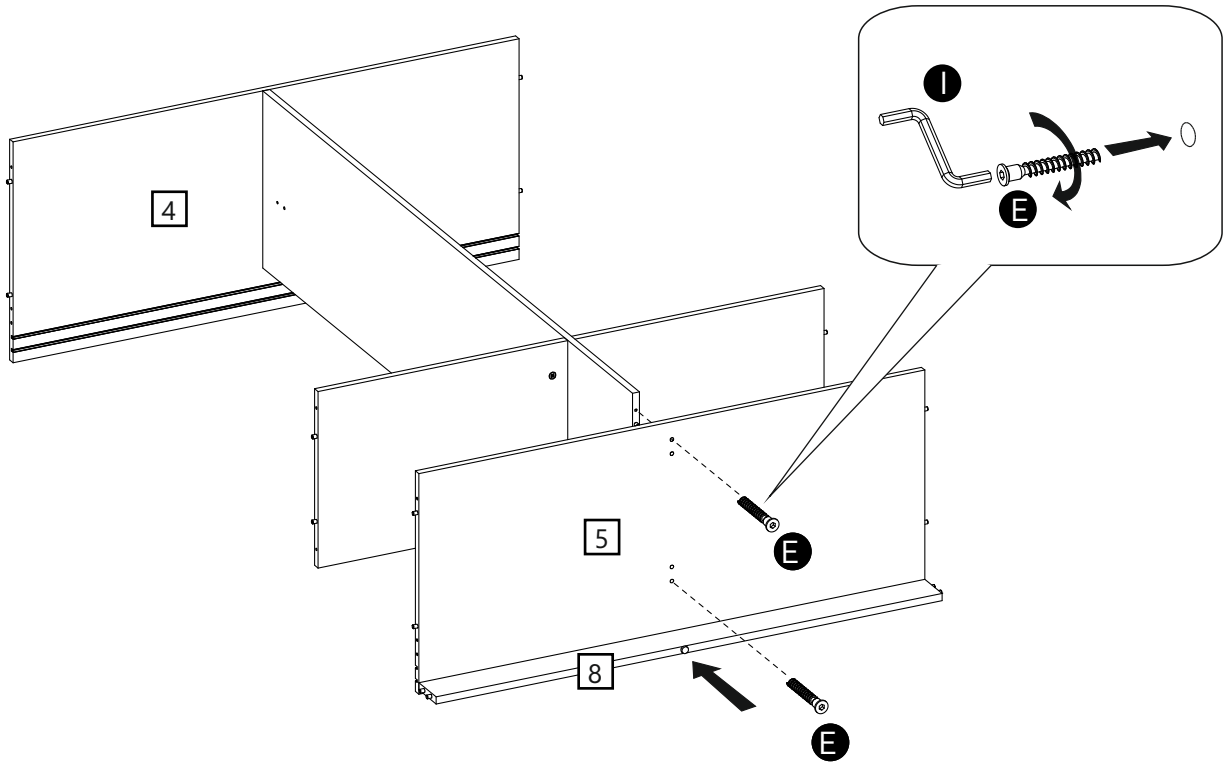
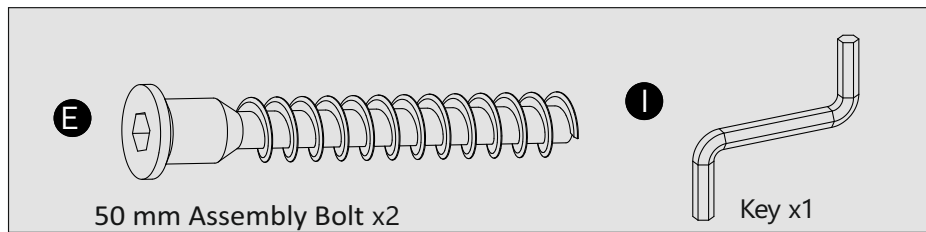

11

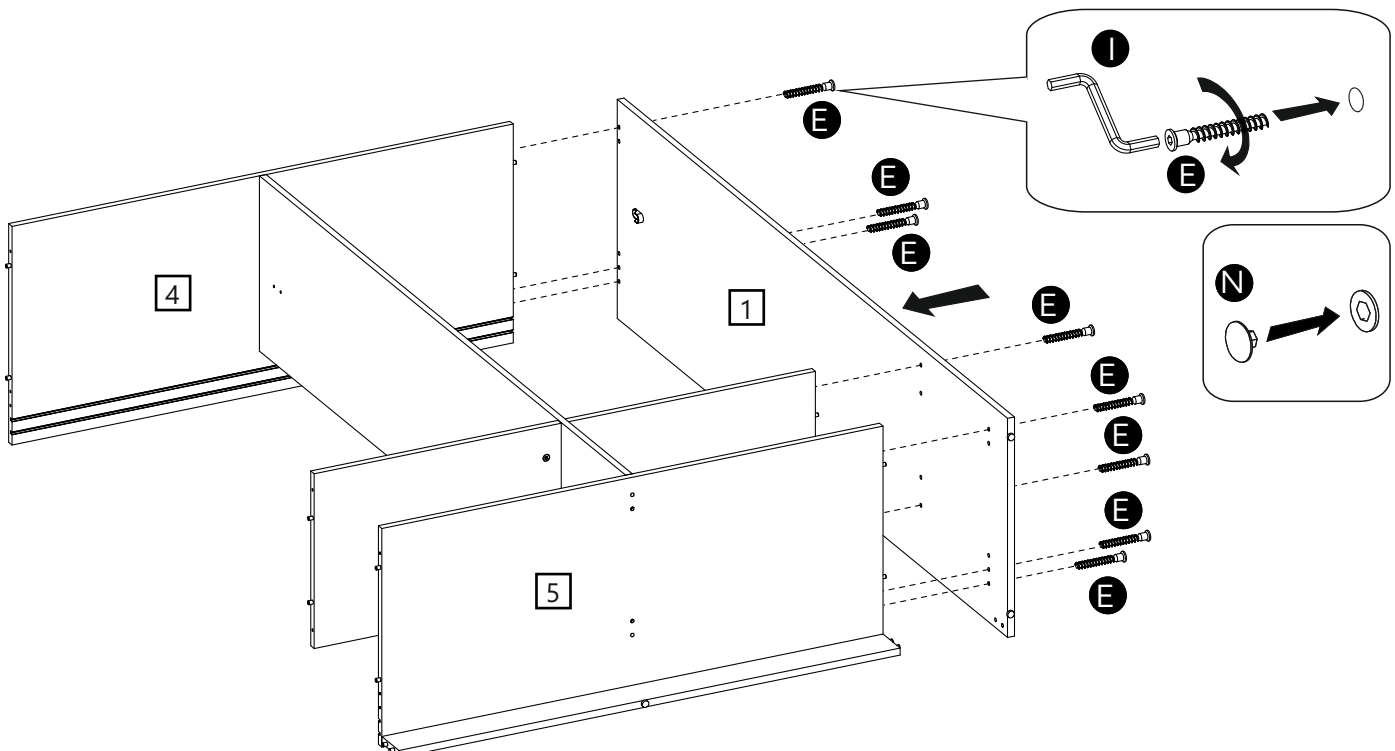
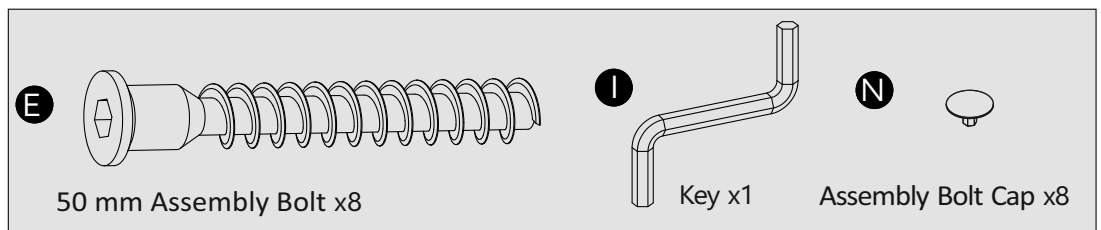

12

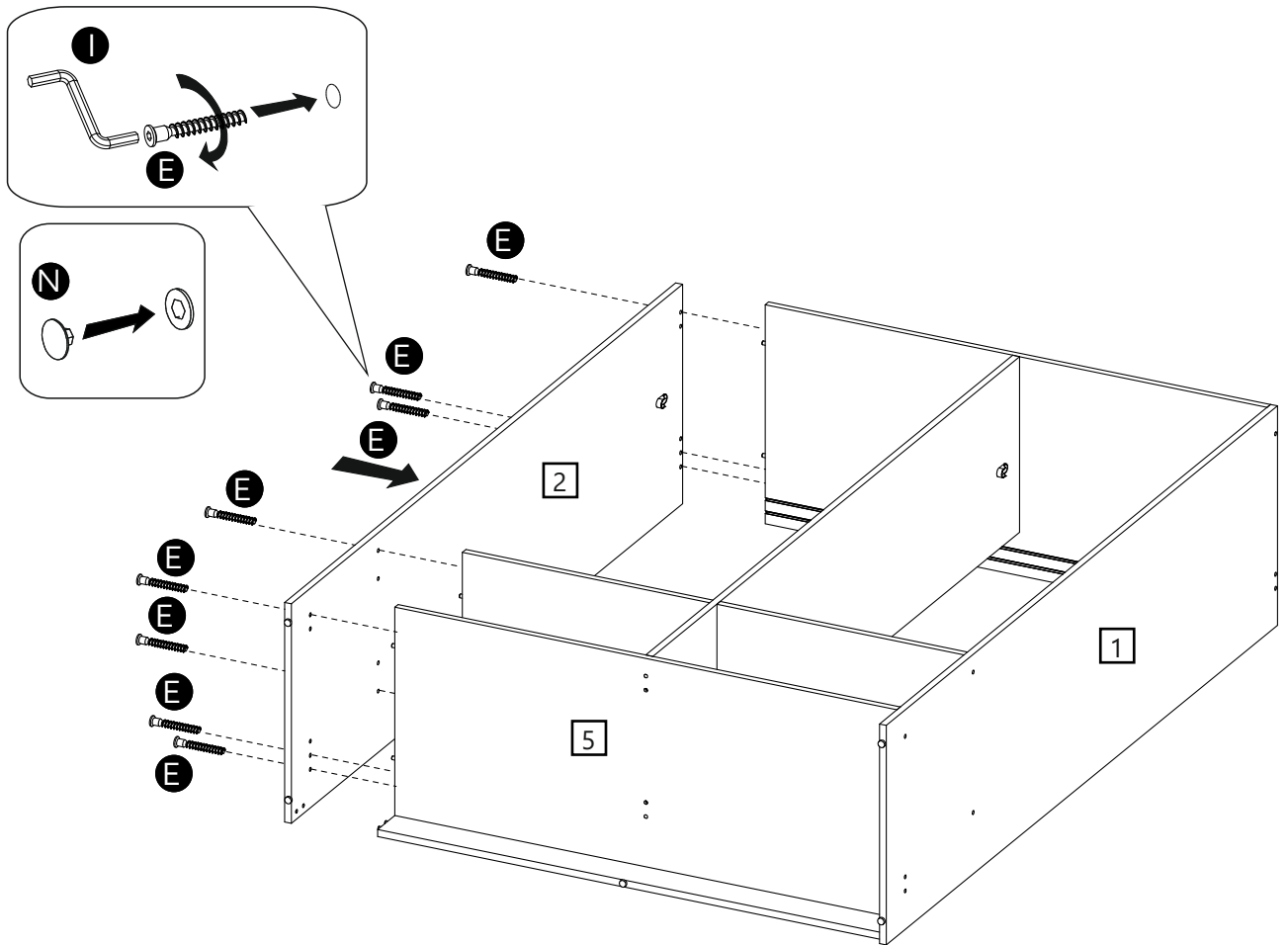
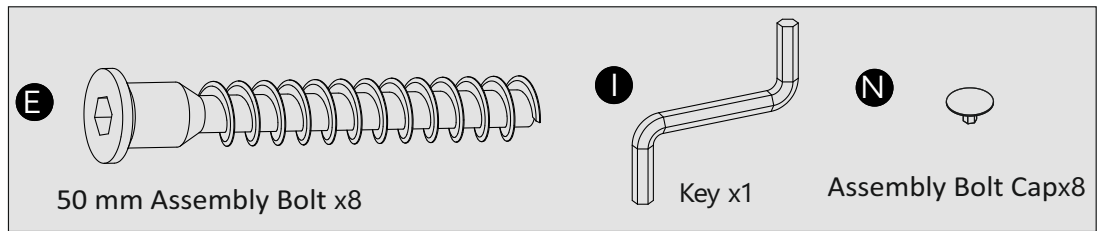

13

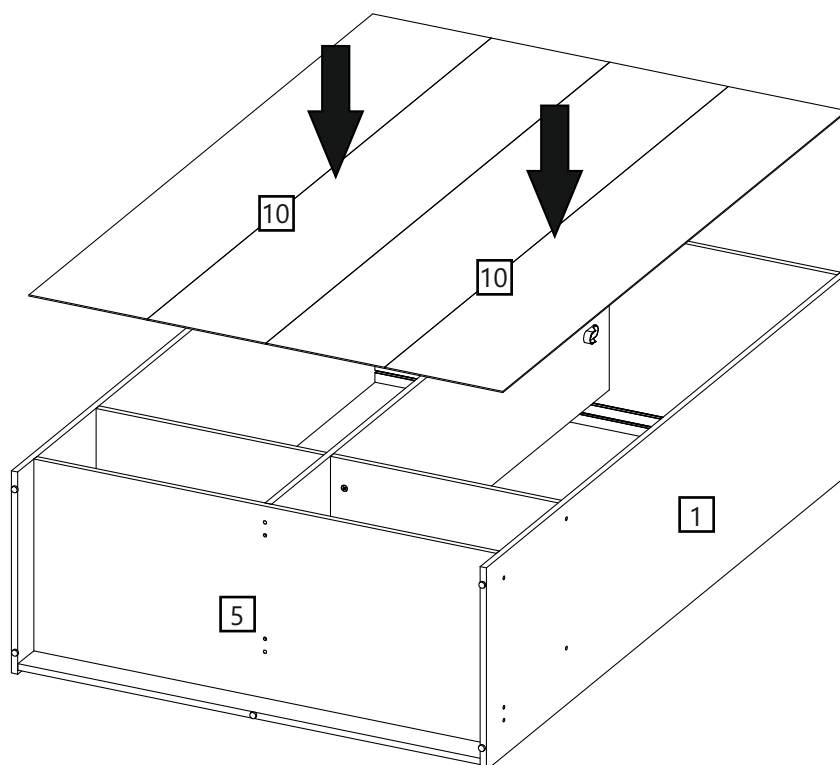

14

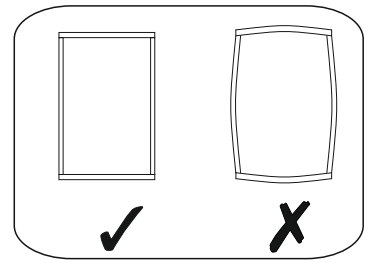
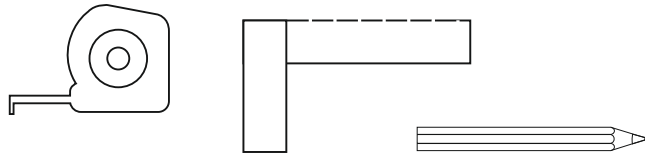

A=B

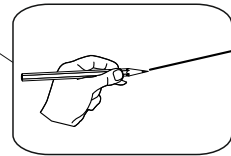
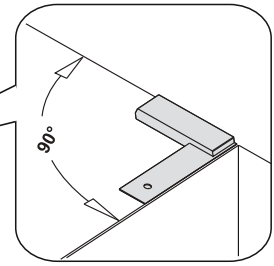
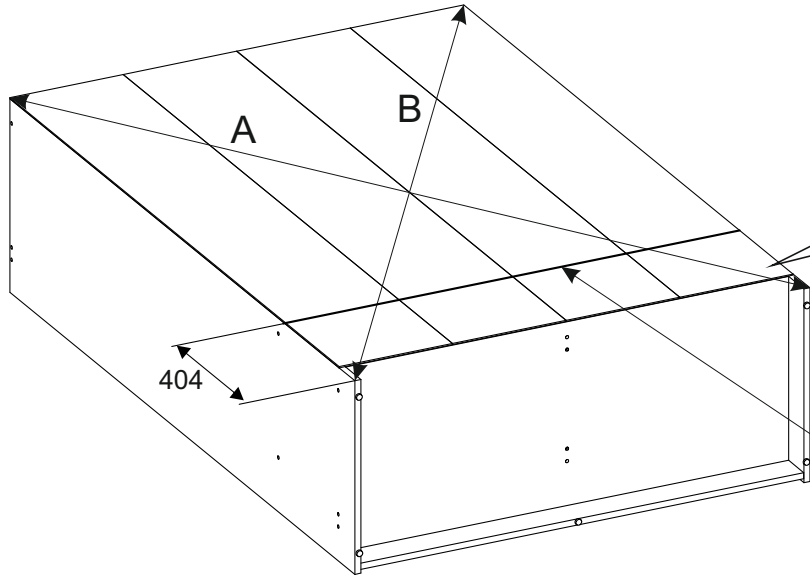

15

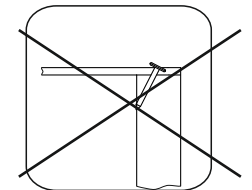
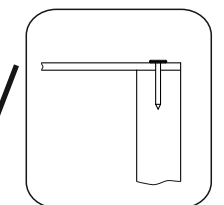
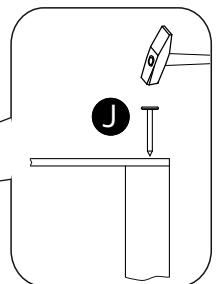
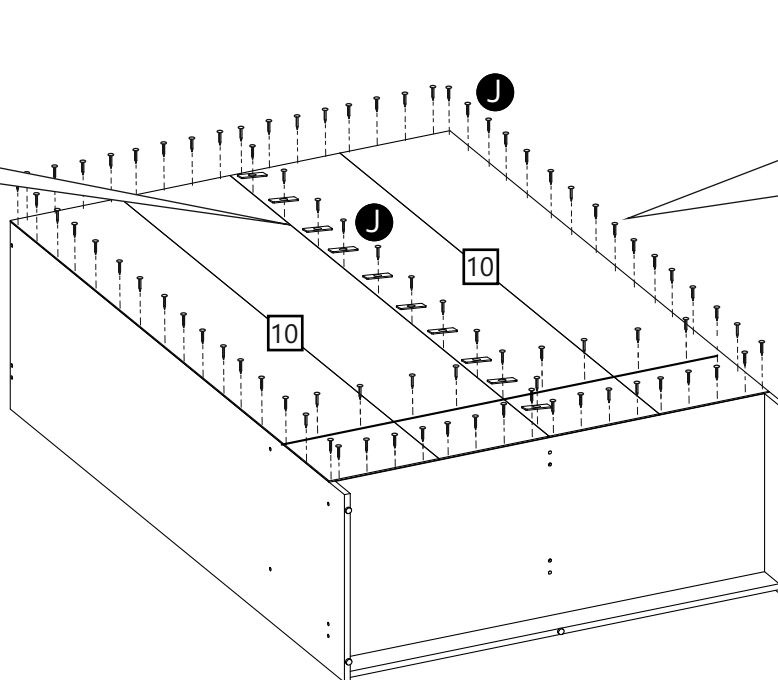
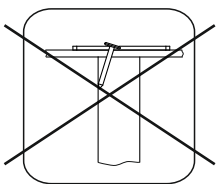
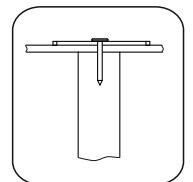
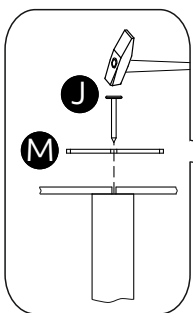
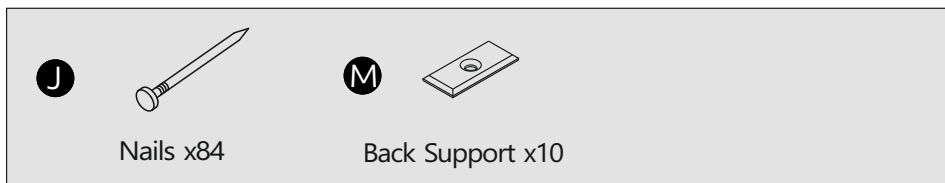

16

Ⓞ

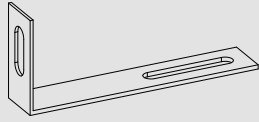

Wall Fixing Bracket x2

Ⓒ

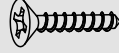

16mm Screw x2

Ⓖ

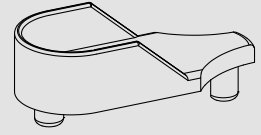

Hanging Rail Support x1

WARNING!

IN ORDER TO PREVENT OVERTURNING
THIS PRODUCT MUST BE USED WITH
THE WALL ATTACHMENT DEVICE
PROVIDED

Ⓟ



Hanging Rail x 2

Ⓕ

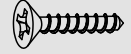

13mm Screw x1

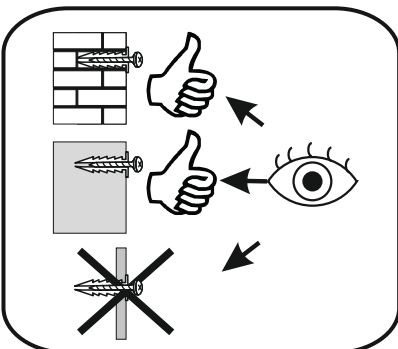
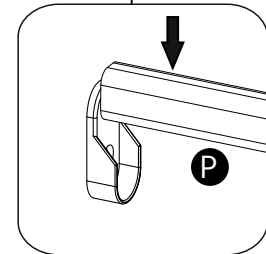
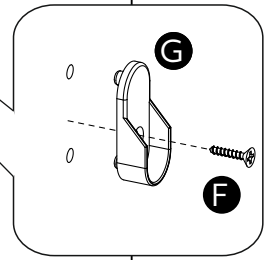
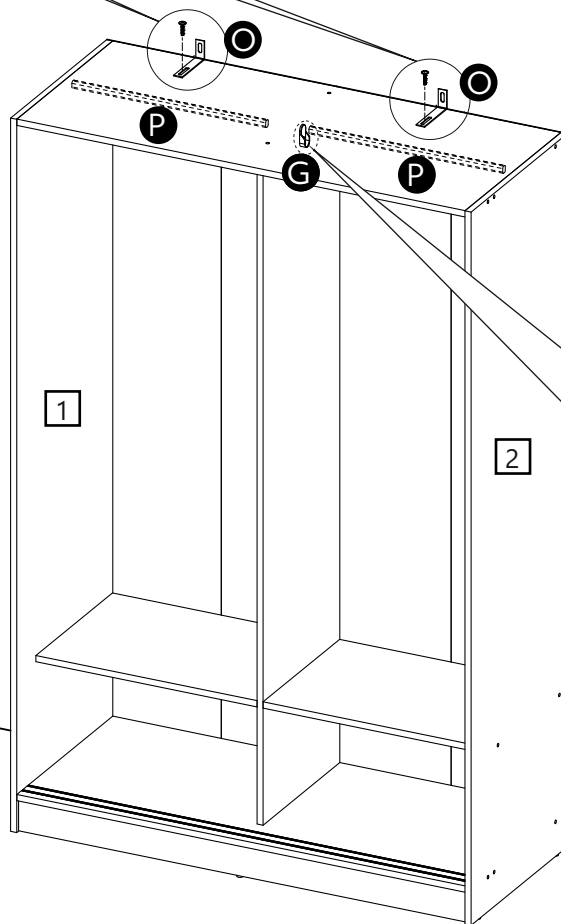
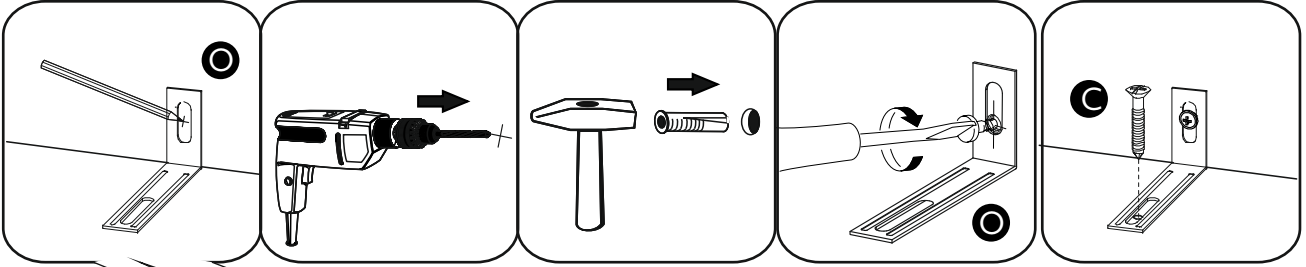

17

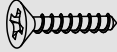
F  13mm Screw x8

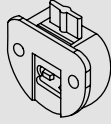
S  Top Door Bracket x 4

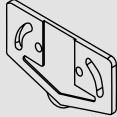
T  Bottom Door Guide x 4

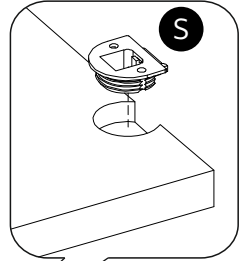
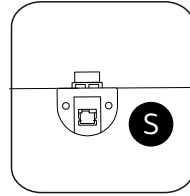
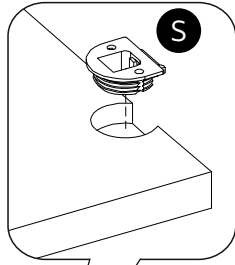

TOP

TOP

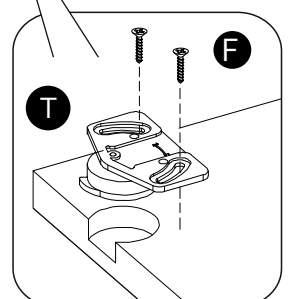
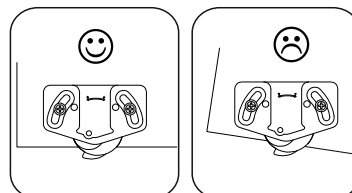
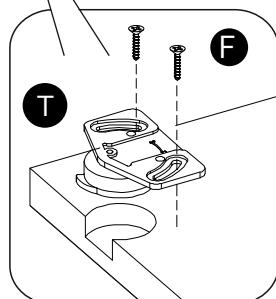
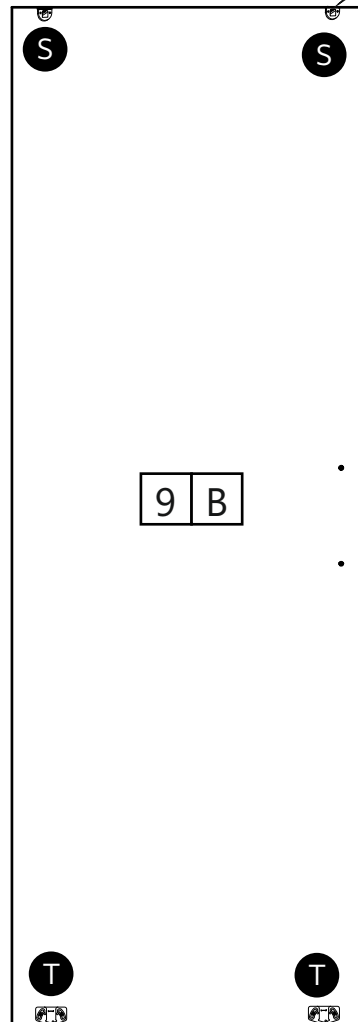
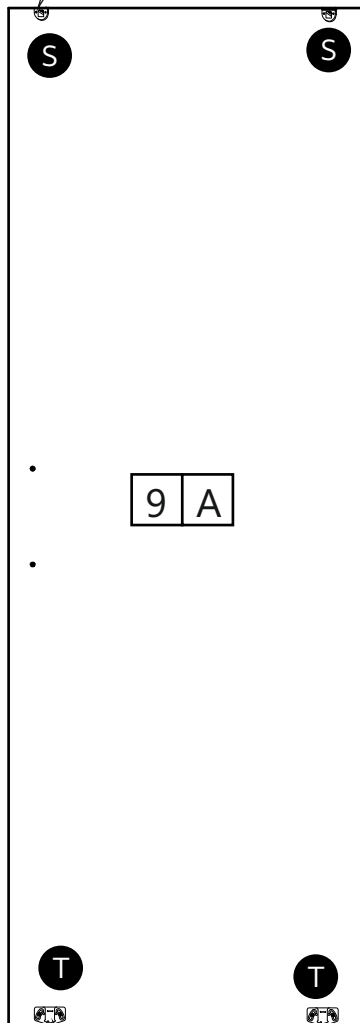

18

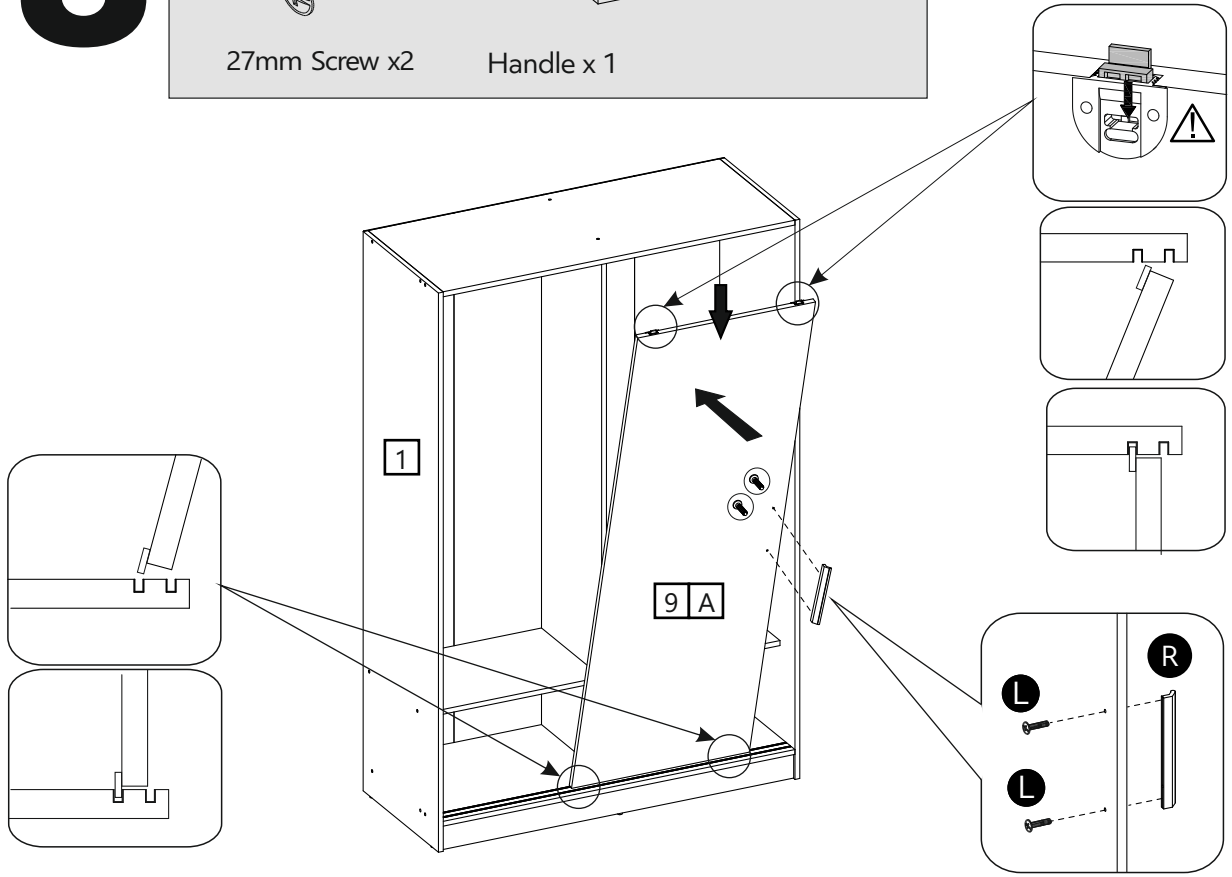
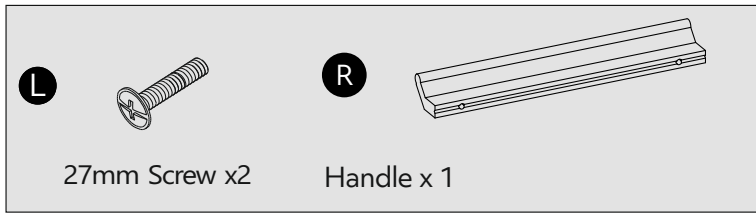

19

