

**morphy richards**<sup>®</sup>  
smart ideas for your home



\*Register at [www.morphyrichards.co.uk/support](http://www.morphyrichards.co.uk/support)  
UK and Ireland customers only

## easy**CHARGE**<sup>POWER</sup> + Cordless Steam Iron



Please read and keep these instructions for future use

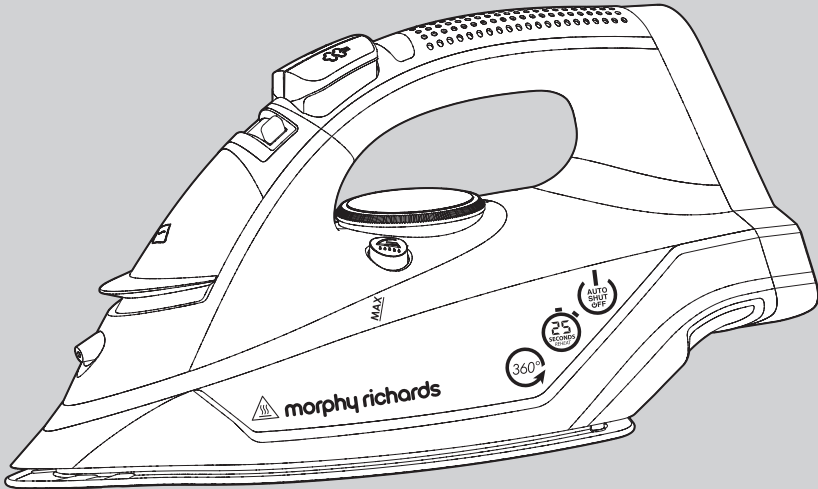

Register your guarantee online: [www.morphyrichards.co.uk/support](http://www.morphyrichards.co.uk/support)

We'll keep you updated with special offers, competitions and important product information.

If you experience any problems with this iron, do not return to the store.

Please contact our help line who will be happy to help:

**UK: 0344 871 0944 IRE: 1800 409 119**

We do stock spare filler lids for this iron, so if you need a replacement please call **0344 873 0710**.



**IMPORTANT:** To reduce limescale damage we recommend using deionised, distilled or demineralised water, available at most large supermarkets. This is particularly important if you live in a hard water area.

Never use battery topping up fluid or water containing any substances like starch, sugar, fragrant additives or defrosted water from a refrigerator.

Failure to maintain your iron will invalidate your guarantee.

[www.morphyrichards.com](http://www.morphyrichards.com)

## Important safety instructions

- **WARNING: Disconnect from the mains supply before carrying out any routine maintenance.**
- **WARNING: Misuse of the appliance could cause personal injury.**
- This appliance can be used by children aged from 8 years and above and persons with reduced physical, sensory or mental capabilities or lack of experience or knowledge if they have been given supervision or instruction concerning use of the appliance in a safe way and understand the hazards involved.
- Children shall not play with the appliance.
- Cleaning and user maintenance shall not be made by children without supervision.
- Keep the iron and its cord out of reach of children less than 8 years of age at all times.
- The iron must not be left unattended while it is connected to the supply mains.
- The plug must be removed from the socket before filling the iron with water.
- The iron must be used and rested on a stable surface.
- The iron must only be used with the stand provided.
- When placing the iron on its heel, ensure that the surface on which the heel is placed is stable.
- The iron is not to be used if it has been dropped, if there are visible signs of damage or it is leaking.
- The filling aperture must not be opened during use.
- Do not operate with a damaged supply cord or grommet, it must be replaced by the manufacturer, its service agent or similarly qualified person in order to avoid a hazard.



**CAUTION - HOT: Burns can occur from touching hot parts, hot water or steam.**

• **WARNING: To avoid electric shock, do not immerse appliance in water / liquid.**

### Electrical requirements and mains cable

- Check that the voltage on the rating plate of your appliance corresponds with your house electricity supply which must be A.C. (Alternating current).
- Do not let the mains lead come into contact with the hot soleplate of the iron.
- Should the fuse in the mains plug require changing, replace it with a fuse of the same rating as originally fitted.
- **WARNING: This appliance must be earthed. PLEASE READ ALL INSTRUCTIONS AND KEEP FOR REFERENCE**

## Steam iron overview

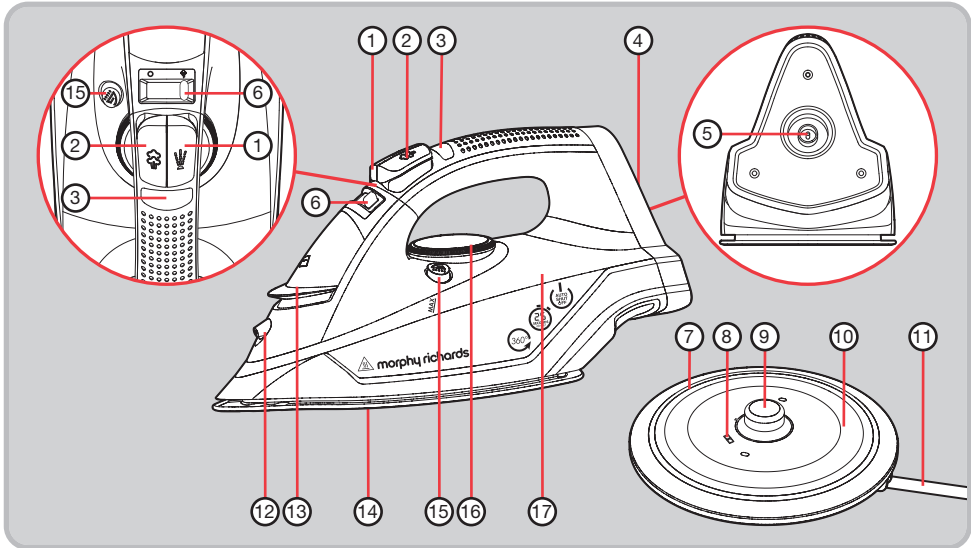

- |                                 |                                   |                            |
|---------------------------------|-----------------------------------|----------------------------|
| (1) Water spray button          | (7) Charging base indicator light | (13) Filling hole with cap |
| (2) Steam boost button          | (8) Charging base sensor          | (14) Soleplate             |
| (3) Temperature indicator light | (9) Charging base connector       | (15) Self clean button     |
| (4) Iron heel                   | (10) Charging base                | (16) Temperature dial      |
| (5) Heel connector              | (11) Power cord                   | (17) Water tank            |
| (6) Steam switch                | (12) Spray nozzle                 |                            |

## Temperature guide

Heat setting markings on the temperature dial of all Morphy Richards irons match those of the International Textile Care Labelling Code

Symbol	(120°C Max) Cool	(160°C Max) Warm	(210°C Max) Hot	MAX setting
Control dial positions	Do not iron	•	••	•••
Fabric	Nylon, Acetates, synthetic fabrics	Wool, Polyester mixtures	Cotton, Linen Rayon, Rayon mixtures	
Ironing	Iron on wrong side, if moisture required, use damp cloth (not Acetate)		Fabrics requiring this setting usually require steam pressing.	
With water in tank	← Steam/spray/shot of steam →			
	← Dry and spray →			
Without water in tank	← Dry ironing →			

## Using the iron

### 1) Filling the tank

Before first use, remove all packaging, including the protective cover on the soleplate. Make sure the iron is not plugged in. Set the steam switch (6) to off. Fill the water tank (17) via the filling hole (13). To fill the tank with the maximum amount of water, we recommend the iron is tilted approximately 45° whilst being filled.

**Do not overfill the iron otherwise it will cause leaking from around the filler cap and may run down the iron. WE RECOMMEND THE USE OF DEIONISED, DISTILLED OR DEMINERALISED WATER.**

**Never use battery topping up fluid or water containing any substances like starch, sugar, fragrant additives or defrosted water from a refrigerator. NOTE: Please see point 2 of 'Exclusions' on page 8.**

### 2) Charging base

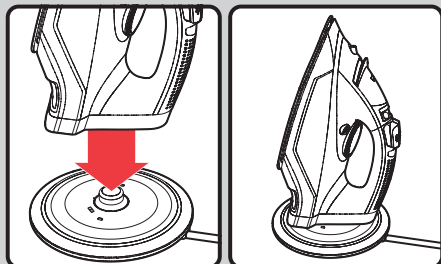

Plug in the charging base (10) and switch on at the mains. The charging base indicator light (7) will illuminate red.

Rest the iron on its heel (4) on the charging base, ensuring that the heel connector (5) meets the charging base connector (9). Connection is made when the temperature indicator light (3) on the handle illuminates red. Wait until the iron reaches the desired temperature (see step 3), then commence ironing.

**Throughout your ironing session, the iron must be replaced onto the charging base every few seconds or whenever you adjust your garments, to keep the heat topped up. If the charging base indicator light (7) is flashing red, the iron must be replaced onto the charging base until the red light turns green again, then you can recommence ironing.**

### 3) Temperature Selection

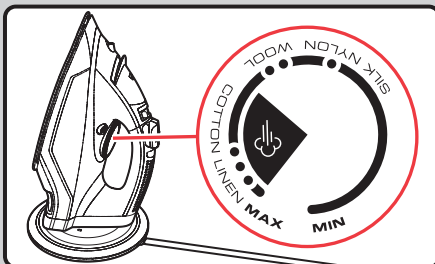

Set the temperature dial (16) to the temperature required (see 'Temperature Guide' on page 3). **The charging base indicator light (7) and the temperature indicator light (3) will illuminate red until the required temperature is reached, then they will turn green.**

**NOTE:** It is normal for the temperature indicator light (3) to flicker between red and green whilst the temperature cycles up and down during charging.

**Tip:** We recommend the temperature indicator light is allowed to cycle red and green twice before you begin ironing.

The temperature indicator light (3) will extinguish when the iron is removed from the base.

**Tip:** Begin with cool fabrics and work up to higher settings. An iron heats up quicker than it cools down so this will save you time and energy.

### 4) Switching on the steam

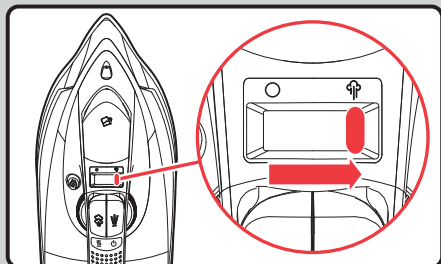

If required, switch on the steam using the steam switch (6).

The amount of steam is automatically adjusted to suit the temperature selected.

The iron will only produce steam when the temperature is set within the steam quadrant on the temperature dial (16), eg. if the 2 Dot setting is selected, the iron will not steam.

### 5) Using the water spray

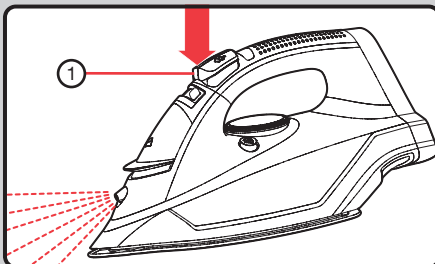

For stubborn creases, use the water spray button (1).

If using for the first time, you may need to press this a few times to pull the water through.

## Using the iron for steam ironing (continued)

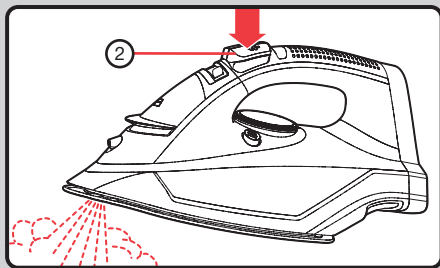

### 6) Steam boost

Press the steam boost button (2) for an extra steam burst for stubborn creases / heavy fabrics. Unlike the constant steam function, the steam boost function may also be used with the 1 or 2 dot temperature settings.

NOTE: To avoid excess moisture, never operate the steam boost more than three times in quick succession.

## Charging Base Indicator Lights Explained

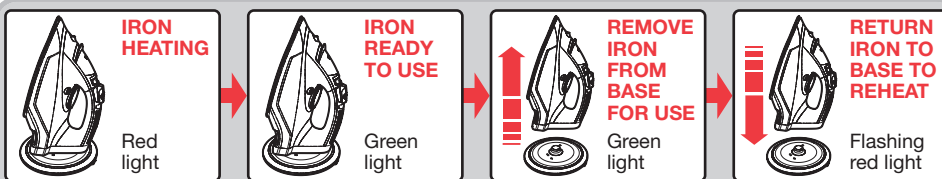

**WARNING:** Do not obscure the charging base sensor (8) at any time, otherwise the charging base indicator light (7) may not light up correctly. Clean away any water or dirt that collects on it.

## Features of your iron

### Dry ironing

Your iron can be used for dry ironing. Set the steam switch (6) to off and set the temperature dial (16) as desired (see page 3).

You won't need water in the tank unless using the water spray or steam boost features.

### Vertical steam

Vertical steam is useful for removing creases from hanging clothes, curtains, etc. Set the temperature to MAX. Hold the iron between 1cm and 2cm away from the item (ensuring the soleplate does not touch any delicate fabrics) and press the steam boost button (2).

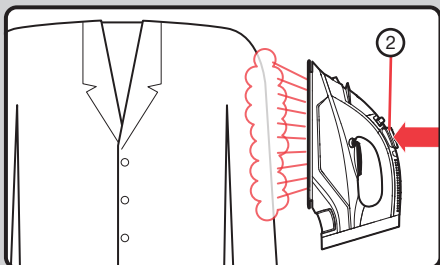

### Anti-drip system

This prevents water escaping from the soleplate (14) when the iron is too cold.

During use, the anti-drip system may emit a loud click, particularly during heat-up or whilst cooling down. This is perfectly normal and indicates that the system is functioning correctly.

### Anti-scale system

This system reduces scale deposits and helps prolong the life of the iron.

### Auto shut-off

If the iron is not taken off the charging base (10) for 8 minutes, the product will automatically turn off for safety and to save energy. When this happens, the temperature indicator light (3) will flash.

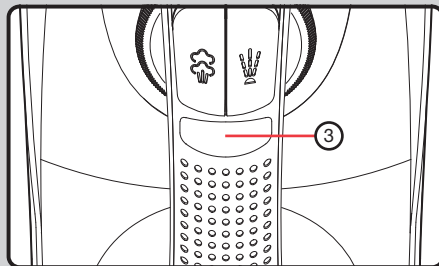

To restart the iron, disconnect the iron from the charging base and replace, then wait for the temperature to rise again.

NOTE: The appliance is not turned off completely in auto shut-off mode. To switch the product off, unplug the product from the mains outlet.

## Maintaining your iron

### Emptying and storing

When you have finished ironing, unplug and empty all water from your iron and set the steam switch at the off position. When cool, store the iron on its heel (4) on the charging base (10) with the power cord (11) wrapped loosely around the iron's heel.

NOTE: Please see point 4 of 'Exclusions' on page 8.

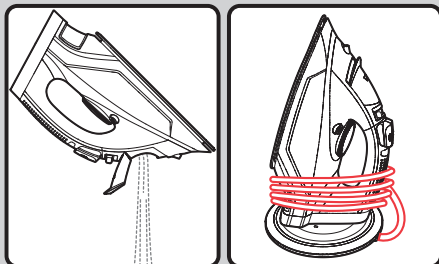

### Cleaning the soleplate

Do not use scouring powder or solution as this could cause damage to the coating.

If any man-made fibres fuse to the soleplate (14), set the iron at the MAX position and pass it over a clean piece of cotton to draw the deposit off the surface.

### To clean the exterior

Allow the unit to cool and wipe over with a damp cloth and mild detergent, then wipe dry.

### Self clean

Your iron has a built in self clean system designed to keep the water valve, steam chamber and steam vents clear of lint and loose mineral deposits.

- 1 Fill the iron with water to the MAX line.
- 2 Set the steam switch (6) to the OFF position.
- 3 Connect the charging base (10) to a mains supply outlet and rest the iron on its heel (4) on the charging base.
- 4 Set the temperature dial (16) to the MAX setting and wait for the temperature to be reached - the temperature indicator light (3) will illuminate red until the required temperature is reached, then it will turn green.
- 5 Whilst the iron is still very hot, hold the iron horizontally over a sink.

**CAUTION:** The soleplate (14) will still be hot, so ensure the charging base (10) and plug are kept away from it and the sink.

- 6 Press and hold the self-clean button (15).

**WARNING:** Steam and boiling hot water will drain from the holes in the soleplate. Keep hands and body away from the hot water. This washes away the scale and minerals that have built up inside the steam chamber.

- 7 Whilst still holding the self-clean button, gently move the iron back and forth until the water tank (17) is empty.
- 8 When steam and hot water cease to be released from the soleplate (14), release the self-clean button (15).
- 9 When the process is complete, re-connect the iron heel (4) to the charging base (10) and allow to heat up - this will dry the soleplate.
- 10 Disconnect the charging base (10) from the mains supply outlet.
- 11 With the iron resting on its heel (4), allow it to fully cool down.
- 12 Wipe the soleplate with a cold, damp cloth.

After this cleaning operation, empty out any remaining water.

**IMPORTANT:** Do not attempt to descale the soleplate with descaling products.

## Troubleshooting

### Problem

- No power or not heating up.

### Solution

1. Check the fuse. Try a new fuse with the same rating.
2. Try a different appliance in the socket as it may be the socket that is at fault.
3. Check the temperature dial has not been set to MIN.
4. Ensure good connection between the iron and the charging base.
5. Check if the iron has gone into auto shut-off. Try re-activating it.

- 
- The charging base indicator light remains on one colour.

1. Check that the top of the charging base is clean, dry and with no obstructions to obscure the charging base sensor.

- 
- Overheating or not getting hot enough.

1. Adjust the temperature dial to ensure the setting matches that recommended on the garment or refer to the “temperature guide” section.
2. Allow the iron to reach temperature and stabilise for 1-2 minutes if it has just been plugged in or re-activated from auto shut-off.
3. Return the iron onto the charging base every few seconds to top up the heat.

- 
- Not steaming or poor steam.

1. Check that there is enough water in the tank.
2. Allow the iron to reach temperature before using steam.
3. Perform a self-clean to clear away limescale inside the iron (refer to “Self Clean” section).

- 
- Dripping from the holes in the soleplate.

1. Allow the iron to reach temperature before using steam.
2. Return the iron onto the charging base every few seconds to top up the heat.

- 
- Tripping Electrics.

1. Try using a different socket.
2. Ensure there are no other appliances being used on the same set of sockets as the iron.

- 
- The filler cap is broken or does not close properly.

1. Call our helpline to order a new replacement filler cap to be sent out.

- 
- The iron emits some white powder from the soleplate.

1. If the iron is new, this is residue from manufacturing materials and will diminish after the first couple of uses.
2. If the iron has been used many times, this could be a sign of limescale build-up and a self clean should be performed. Please see “Maintaining your iron” section.

- 
- Leaking water.

1. Do not overfill the iron.
2. Ensure the filler cap is closed properly.

## Registering your guarantee

Your standard 1 year guarantee is extended for an additional 2 years when you register the product within 28 days of purchase with Morphy Richards. If you do not register the product with Morphy Richards within 28 days, your product is guaranteed for 1 year. To validate your 3 year guarantee register with us online at [www.morphyrichards.co.uk/support](http://www.morphyrichards.co.uk/support)

Or call our customer registration line

UK 0344 871 0242

IRE 1800 409 119

N.B. Each qualifying product needs to be registered with Morphy Richards individually.

Please note that the 3 year guarantee is only available in the UK and Ireland. Please refer to the 1 year guarantee for more information.

## Your 1 year guarantee

It is important to retain the retailer's receipt as proof of purchase. Staple your receipt to this back cover for future reference.

Please quote the following information if the product develops a fault. These numbers can be found on the base of the product.

Model no.

Serial no.

All Morphy Richards products are individually tested before leaving the factory. In the unlikely event of any appliance proving to be faulty within 28 days of purchase, it should be returned to the place of purchase for it to be replaced.

If the fault develops after 28 days and within 12 months of original purchase, you should contact the Helpline number quoting Model number and Serial number on the product, or write to Morphy Richards at the address shown.

You may be asked to return a copy of proof of purchase.

Subject to the exclusions (see Exclusions), the faulty appliance will then be repaired or replaced as appropriate and dispatched usually within 7 working days of receipt.

If, for any reason, this item is replaced or repaired during the 1 year guarantee period, the guarantee on the new item will be calculated from original purchase date. Therefore it is vital to retain your original till receipt or invoice to indicate the date of initial purchase.

To qualify for the 1 year guarantee, the appliance must have been used according to the instructions supplied.

## Exclusions

Morphy Richards shall not be liable to replace or repair the goods under the terms of the guarantee where:

- 1 The fault has been caused or is attributable to accidental use, misuse, negligent use or used contrary to the manufacturer's recommendations or where the fault has been caused by power surges or damage caused in transit.
  - 2 The fault has been caused by using water other than that recommended by Morphy Richards.
  - 3 The fault is caused by limescale build-up.
  - 4 The cables are damaged due to wrapping too tightly or excessive kinking.
  - 5 The appliance has been used on a voltage supply other than that stamped on the products.
  - 6 Repairs have been attempted by persons other than our service staff (or authorised dealer).
  - 7 The appliance has been used for hire purposes or non domestic use.
  - 8 The appliance is second hand.
  - 9 Morphy Richards reserves the right not to carry out any type of servicing under the guarantee at its discretion.
- This guarantee does not confer any rights other than those expressly set out above and does not cover any claims for consequential loss or damage. This guarantee is offered as an additional benefit and does not affect your statutory rights as a consumer. Morphy Richards products are intended for household use only. See usage limitations within the location safety instructions.

## Disclaimer

Morphy Richards has a policy of continuous improvement in product quality and design. The company, therefore reserves the right to change the specification of its models at any time.



For electrical products sold within the European Community. At the end of the electrical products useful life, it should not be disposed of with household waste.

Please recycle where facilities exist. Check with your Local Authority or retailer for recycling advice in your country.

## Contact us

### Helpline

If you have a problem with your appliance, please call our Helpline, as we are more likely to be able to help than the store you purchased the item from. Please have the product name, model number and serial number to hand when you call to help us deal with your enquiry quicker.

UK Helpline: **0344 871 0944**

IRE Helpline: **1800 409 119**

Spares: **0344 873 0710**

### Talk to us

If you have any questions or comments, or want some great tips to help you get the most out of your products, join us online:

Blog: [www.morphyrichards.co.uk/blog](http://www.morphyrichards.co.uk/blog)

Facebook: [www.facebook.com/morphyrichardsuk](https://www.facebook.com/morphyrichardsuk)

Twitter: [@loveyourmorphy](https://twitter.com/loveyourmorphy)

Website: [www.morphyrichards.com](http://www.morphyrichards.com)

Address: **Stoney Lane**

**Prescot**

**Merseyside**

**L35 2XW**

**UK**

