

[Print this page](#)

For safety and compliance information for this product, click here.

Physically installing your Ring Video Doorbell (2nd Generation) with an existing doorbell is a simple process. Simply scroll down for a step-by-step guide.

Note that you should set up your Ring Video Doorbell in your Ring app before mounting it to your home.

Click here for information on setting up your Ring Video Doorbell (2nd Generation) in the Ring app.

## Step One: Charge the built-in battery

- Fully charge the built-in battery by plugging it into a USB power source using the provided orange cable.
  - When only one of the two LEDs on the battery is lit, the battery is fully charged.

Click here for more information on charging your Ring battery.

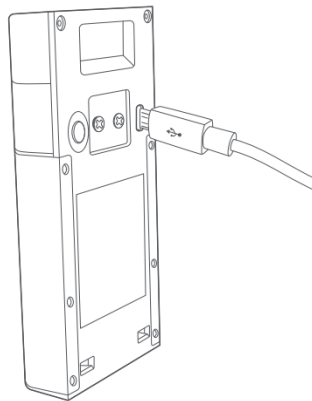

## Step Two: Remove your existing doorbell (optional)

If replacing an existing doorbell, shut off power to your doorbell system at the breaker. Then remove the doorbell button from the wall and disconnect the wires.

**Note:** If wiring your Ring Video Doorbell to an existing doorbell, a transformer with a voltage of 8-24 VAC, 40VA max, 50/60Hz is required.

**Note:** DC transformers and most intercoms are not supported.

## Step Three: Line up your Ring Video Doorbell (2nd Generation)

To properly line up your Ring Video Doorbell:

- Place the Ring Video Doorbell next to your door at about 1.2 metres from the ground.
- Level the mounting bracket, using a level tool if needed.
- Mark the positions for mounting holes with a pencil.

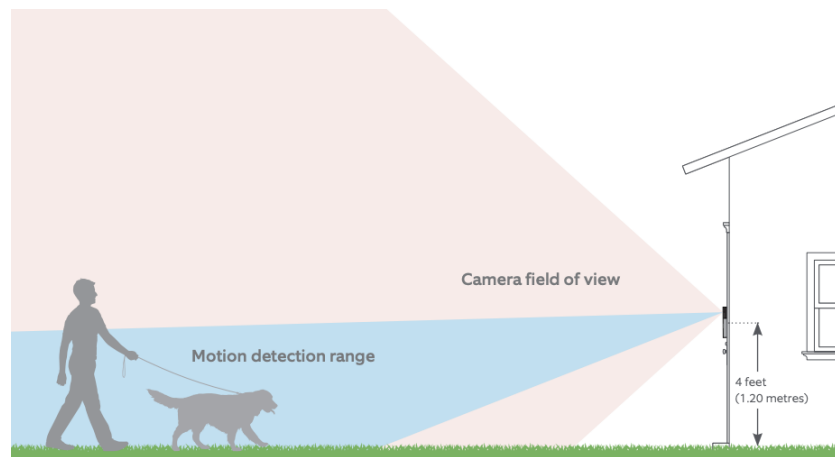

#### Step Four (optional): Mark the screw holes

Use the bracket as a template to mark the four corner holes. The recommended install height is 1.2 metres above the ground.

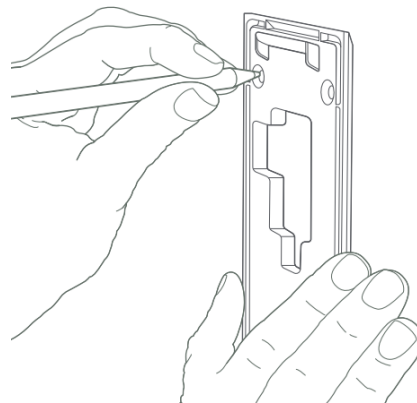

#### Step Five (optional): Drill the mounting holes (only when mounting on brick, concrete or stucco)

- Use the included drill bit in a power drill to drill holes at the positions you marked.
- Insert the included plastic anchors into the holes. You may need to use a hammer to get the anchors in.
- If installing on stucco, brick, or concrete, mark 4 drill holes. Use the provided masonry drill bit to drill holes in your wall, then insert the included anchors. If you're installing on wood, skip this step

#### Step Six (optional): Attach the wire extensions.

If you have trouble connecting the wires coming out of the wall to the back of your Ring Video Doorbell, use the provided wire extensions and wire nuts.

If you're wiring your Video Doorbell, feed your doorbell wires through the hole in the mounting bracket first. Drive the screws into your wall (or into the anchors, if installed) until they are flush with the mounting bracket.

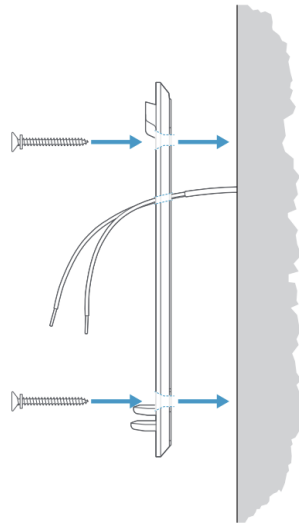

### Step Seven (optional): Connect the wires

Connect the wires coming out of your wall to the screws on the back of your Video Doorbell. Either wire can connect to either screw. The order doesn't matter. Your Video Doorbell is compatible with doorbell systems supplying 8-24 volts AC, 50mA, at 50 or 60Hz, 40VA max.

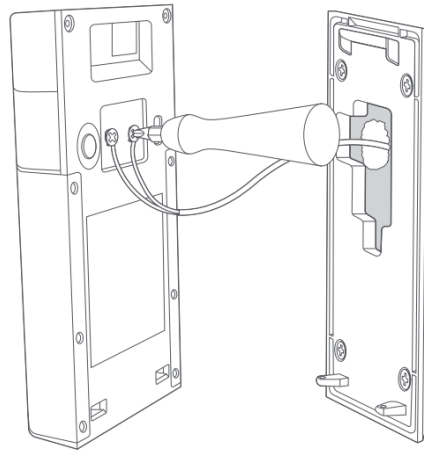

**Note:** Do not use halogen or garden-lighting transformers. Do not use third-party DC supplies.

### Step Seven: Place your Ring Video Doorbell over the holes

Don't forget to remove the level tool from the front of the device.

Hook the slot on the rear of your Video Doorbell onto the tab near the top of the mounting bracket. Then, let the Doorbell pivot down to sit flush on its bracket.

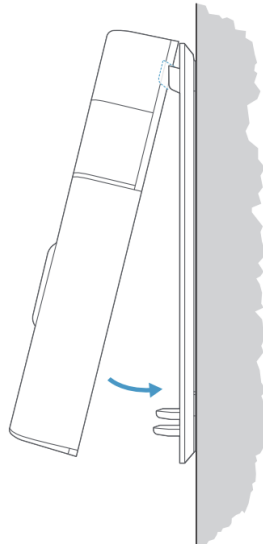

## Step Eight: Screw in the Ring Video Doorbell

Feed all the wires (and the wire nuts if you used them) into your wall and secure your Ring Video Doorbell on the wall. Be sure you use all four included screws.

## Step Nine: Install the security screw

Use one of the provided security screws and the star-shaped end of the screwdriver bit to secure the faceplate at the bottom of your Ring Video Doorbell.

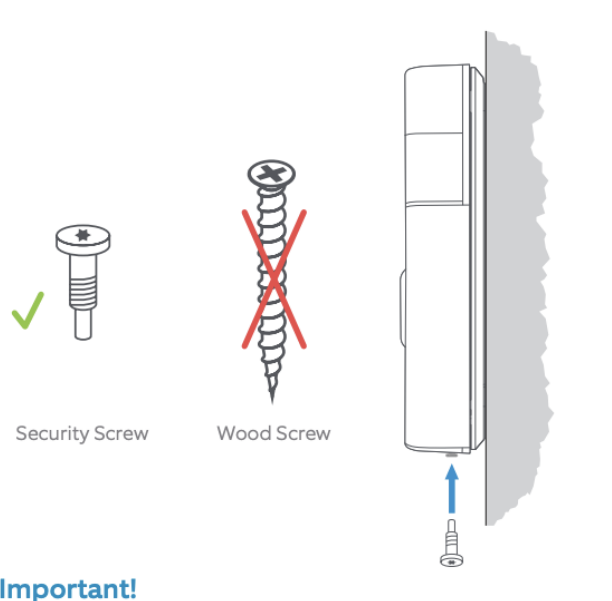

**Note:** For your safety, use only the short security screws under the faceplate. Using any other type of screw could damage the battery and create a potential fire hazard. If you feel that you may have used the wrong screw to install your doorbell, please contact Ring Customer Support.

Once you have hardwired your Ring Video Doorbell (2nd Generation) to your existing doorbell system, you can set up an in-home chime in the Ring app if want to still hear your old chime. [Click here](#) to learn how to configure your doorbell for an in-home chime.

[Click here](#) for information on setting up your Ring Video Doorbell (2nd Generation) in your Ring app.