

A	1	2	3	重要度	4 [B]		
B	<h3 style="margin: 0;">技术要求</h3> <ol style="list-style-type: none"> 1. 颜色要求：封面：黑白印刷； 内页：黑白印刷； 批量时要求统一，不能有明显色差， 2. 版面内容：封面：印刷内容，字高需大于3mm 6-10页大写字，高需大于3mm 图案与文字应有印刷清晰、 规范，不能有印刷缺陷； 3. 页面印刷：双面印刷； 4. 成型方式：骑马钉； 5. 成品尺寸：A5 (140X210) 尺寸公差按GB/T 1804-c； 6. 批量生产前须送样确认。 						
C							
D							
借(通)用件登记					封面：80g双胶 内页：80g双胶	广东奥马冰箱有限公司	
出图审查	标志	处数	更改文件号	签名	日期	重量	比例
日期	设计	制图	会签	标准化	刘金利	共 1 张	第 1 张
	审核	黄英婷	批准	李梅方	日期	2021-6-9	CKBSH-D02-M
	工艺		日期	2021-6-9	视角符号		
	1	2	3	4			

BUSH

Instruction Manual

ME60170TFW

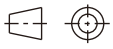

You'll soon be enjoying your new refrigerator.

It all begins here, with your instructions. Don't worry, there's nothing too technical coming up. Just simple, step-by-step guidance to get you up and running quickly. Sound good? Then let's get started

Help and Guidance

We're here to help you get the most from your refrigerator. Should you require any guidance, a simple solution can often be found online at.

www.bush-support.com





If you still require further assistance, call one of our experts on 0345 257 7271.

Issue1 01/04/2021

If you require any technical guidance or find that your product is not operating as intended, a simple solution can often be found in the **Troubleshooting** section of these instructions.

Contents

1	Safety information		
	Safety information	6	
2	Getting to know your refrigerator		
	Ready? Let's begin...	13	
	Parts	14	
3	Installing your refrigerator		
	Transportation	17	
	Installation	17	
	Door Reverse	18	
	Electrical Connection	19	
4	Using your refrigerator		
	Before first use	22	
	Using your appliance	22	
	Useful information	22	
5	Care and Maintenance		
	General	26	
	Power failure	26	
	Moving your appliance	26	
	Technical Specifications	27	
6	Product support		
	Trouble Shooting		30
	Help and assistance		31
	Guarantee		32

Icon	Type	Meaning
	WARNING	Serious injury or death risk
	RISK OF ELECTRIC SHOCK	Dangerous voltage risk
	FIRE	Warning; Risk of fire / flammable materials
	CAUTION	Injury or property damage risk
	IMPORTANT	Operating the system correctly

If you require any technical guidance or find that your product is not operating as intended, a simple solution can often be found in the Troubleshooting section of these instructions.

Safety information

1

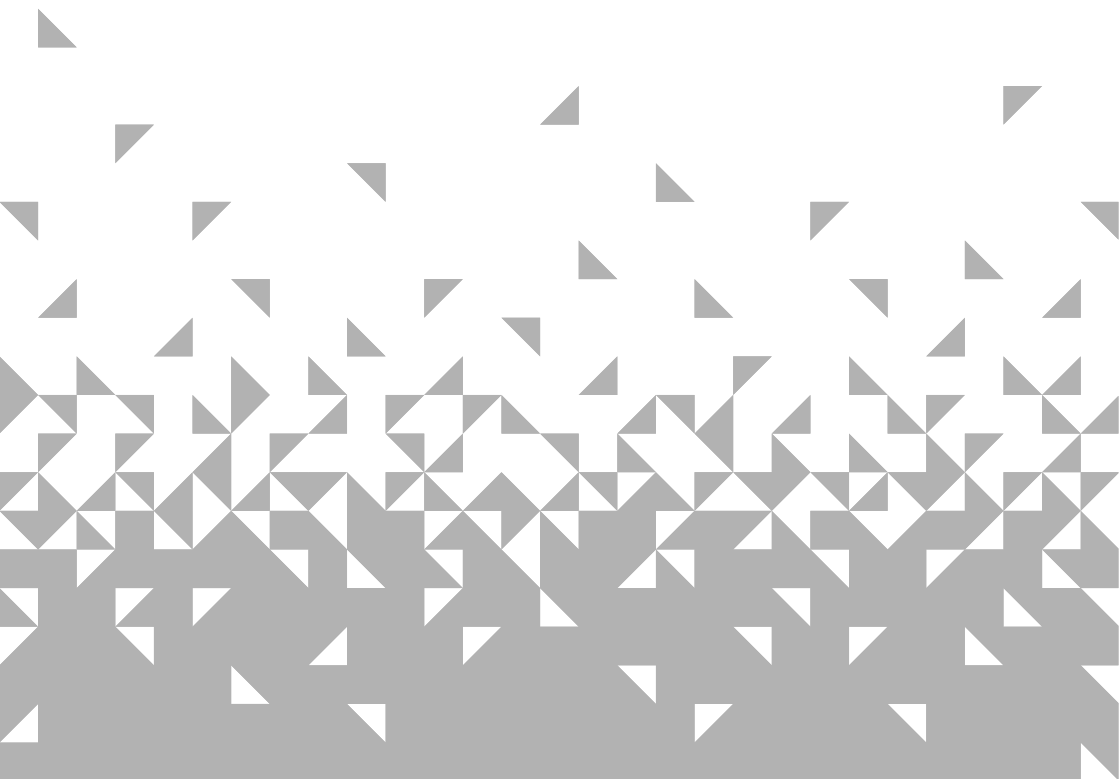



Safety information

Important-Please read these instructions fully before installing or operating

Before use

The installation of this appliance is best carried out by 2 people.

- Dispose of all packaging carefully and responsibly.
- The appliance is designed for **indoor use only** and must be protected from rain, moisture and extreme temperature variations.
- This appliance is designed for house hold use. **Do not** use the appliance for industrial and commercial use, or any other purpose.
- The appliance **MUST** be positioned on a firm level base.
- **Do not** splash water on the appliance. It may cause electrical parts to fail and result in an electric shock.
- Leave the appliance in its intended place of installation and in its correct orientation for at least 4 hours before switching on to allow the cooling system to settle before first use or after any transportation.
- Your appliance is an environmental friendly product and it contains non CFC/HFC gas substances in the cooling system (Called R600a) and in the insulation (Called cyclopentane) which are potentially flammable if exposed to fire. Therefore, take care not to damage, the cooling circuit/pipes of the appliance in transportation and in use. In case of damage do not expose the appliance to fire,



Safety information

Important-Please read these instructions fully before installing or operating

potential ignition source and immediately ventilate the room where the appliance is situated.

- **Do not** sit, stand or place any other heavy objects on top of the appliance. This could result in injury or damage to the appliance.
- **Do not** allow children to play with the appliance to avoid the risk of entrapment and suffocation.
- Keep ventilation opening, in the appliance enclosure or in the built-in structure, clear of obstruction.

During use

- This appliance is not intended for use by persons (including

children) with reduced physical, sensory or mental capabilities, or lack of experience and knowledge, unless they have been given supervision or instruction concerning use of the appliance by a person responsible for their safety. Children should be supervised to ensure that they do not play with the appliance.

- This appliance is not intended for use by young children or infirm persons unless they have been adequately supervised by a responsible person to ensure that they can use the appliance safely. Young children should be supervised to ensure that they do not play with the appliance.

- **Do not** use mechanical,



Safety information

Important-Please read these instructions fully before installing or operating

electrical or chemical way to speed up the defrost process not recommended by the manufacturer.

- **Do not** use or place other electrical products inside the appliance not recommended by the manufacturer.
- **Do not** store liquids in glass containers in the freezer compartment as these may shatter.
- **Do not** store flammable materials such as alcohol, gasoline, LP gas or glue etc in the appliance.
- In case there is an inflammable gas leaking, open the window for air circulation and do not pull out the plug or turn the temperature knob. **Do not** touch the appliance until the valve of gas is turned off. Otherwise, sparks may happen.
- This appliance can be used by children aged from 8 years and above and persons with reduced physical, sensory or mental capabilities or lack of experience and knowledge if they have been given supervision or instruction concerning use of the appliance in a safe way and understand the hazards involved. Children shall not play with the appliance. Cleaning and user maintenance shall not be made by children without supervision.
- **Do not** attempt to repair the appliance yourself. Contact the Customer Helpline:0345 257 7271.



Safety information

Important-Please read these instructions fully before installing or operating

- Children aged from 3 to 8 years are allowed to load and unload this appliance.
 - ⚠ **WARNING!** When positioning the appliance, ensure the supply cord is not trapped or damaged.
 - ⚠ **WARNING!** Do not locate multiple portable socket-outlets or portable power suppliers at the rear of the appliance.
- To avoid contamination of food, please respect the following instructions
- Opening the door for long periods can cause a significant increase of the temperature in the compartments of the appliance.
 - Clean regularly surfaces that can come in contact with food and accessible drainage systems.
 - Clean water tanks if they have not been used for 48h; flush the water system connected to a water supply if water has not been drawn for 5 days.
 - Store raw meat and fish in suitable containers in the refrigerator, so that it is not in contact with or drip onto other food.
 - Two-star frozen-food compartments(if they are presented in the appliance) are suitable for storing pre-frozen food, storing or making ice-cream and making ice cubes.





Safety information

Important-Please read these instructions fully before installing or operating

One-, two- and three-star compartments (if they are presented in the appliance) are not suitable for the freezing of fresh food.

- If the appliance is left empty for long periods, switch off, defrost, clean, dry and leave the door open to prevent mould developing within the appliance.
- The refrigerating appliance is not intended to be used as a built-in appliance, unless specifically shown as such into its instruction manual.
- The drawers, baskets and shelves should be kept in their current position unless otherwise specified in this document.

-   **WARNING!**
During using, service and disposal the appliance, please pay attention to symbol similar as left side, which is located on rear of appliance (rear panel or compressor) and with yellow or orange color.

It's risk of fire warning symbol. There are flammable materials in refrigerant pipes and compressor. Please be far away fire source during using, service and disposal.



Getting to know your refrigerator

2



Getting to know your refrigerator

You'll be up and running in no time

Ready? Let's begin...

Please read these instructions carefully. They contain important information which will help you get the best from your refrigerator and ensure safe and correct installation and operation

If you require any further assistance, our technical experts are happy to help. For full details, refer to the product support section at the end of these instructions.

Getting to know your refrigerator

You'll be up and running in no time

Parts

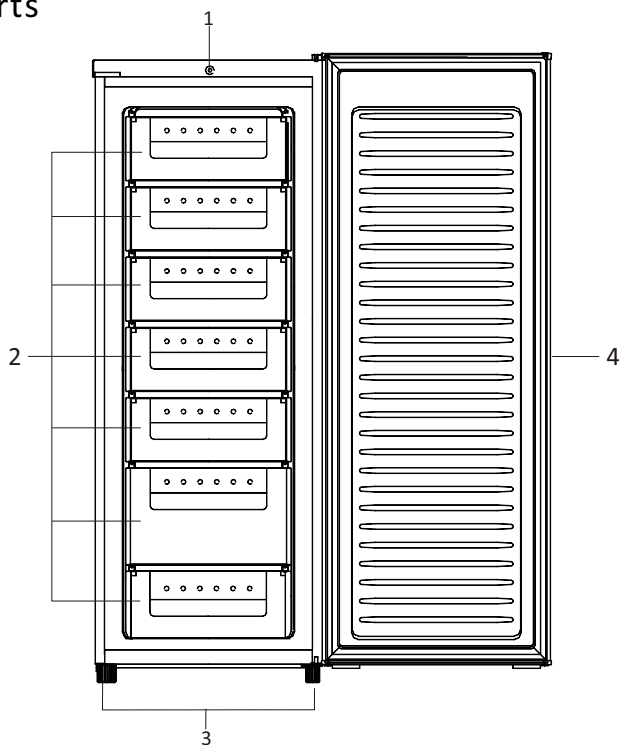

- 1. Thermostat
- 2. Drawers
- 3. Leveling feet
- 4. Door

Accessories included



Instructions x 1

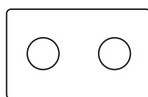

Hinge cover

or online at www.argos-support.co.uk if you still require further assistance, call one of our experts on 0345 257 7271.



Installing your refrigerator 3



Installing your refrigerator

Bringing it all together

Transportation



Caution: 2 people are required to unpack and handle the appliance, it is recommended that gloves are worn.

- The appliance should be transported only in an upright position. Do not tilt the appliance greater than 45 degrees. The packaging as supplied must be intact during transportation.
- After transporting the appliance, leave it for at least 4 hours before switching on to allow the cooling system to settle. Failure to comply could result in damage to the appliance.
- Do not move the appliance by pulling the door or handle as it may damage your flooring and wall coverings etc.
- Empty any water in the drain tray before moving.
- Make sure that the defrost water pipe at the back of the product is fixed to the plastic evaporating pan on the top of the compressor to avoid defrost water spillage on the floor.
- Ensure the supply cable is not caught under the appliance during and after moving.
- Carefully remove all packaging materials including the foam base, dispose of correctly

Installation

- Ensure sufficient spacing is provided for the appliance to be installed. Leave space on both sides (5cm), back (5cm) and above the appliance (5cm) to ensure proper ventilation.

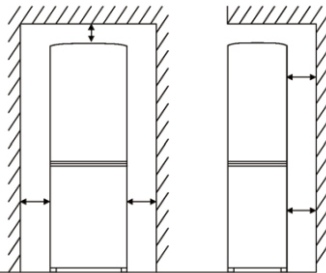

- Do not place the appliance near a heat source or in direct sunlight.
- Do not put any heavy objects on top of the appliance. It will damage the appliance.

- Do not install the appliance in a moist and wet place.

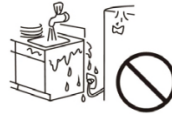

- Adjust the feet at front to level the appliance. It should be installed on a smooth surface to avoid excessive vibration and noise.
- Each appliance has a climate class (shown on the rating plate) where it indicates the temperature range of the appliance operation in place. The appliance may not work properly if it is left for a long period at a temperature outside the specified range:

extended temperate: 'this refrigerating appliance is intended to be used at ambient temperatures ranging from 10 °C to 32 °C (from 50°F to 90°F)';

temperate: 'this refrigerating appliance is intended to be used at ambient temperatures ranging from 16 °C to 32 °C (from 61°F to 90°F)';

subtropical: 'this refrigerating appliance is intended to be used at ambient temperatures ranging from 16 °C to 38 °C (from 61°F to 100°F)';

tropical: 'this refrigerating appliance is intended to be used at ambient temperatures ranging from 16 °C to 43 °C (from 61°F to 110°F)'

- Refer to section Care and Maintenance to prepare your appliance for use.

Installing your refrigerator

Bringing it all together

Door Reverse



Warning: Remove the main plug before reversing the door. 2 people may be required to reverse the door .

- 1.Remove the screws ① from the hinge cover put the hinge cover on the soft pad for future use
- 2.Open the door and remove the screw ⑤ on the top hinge plate ④ from the front side . Then remove the hinge plate ③ carefully . Take out the door from the cabinet and place it on the ground protected with soft pad to avoid any damage .
- 3.Remove plastic cover ⑦ and screws at the top left side ⑥ and fix it to the right side .
- 4.Put the plastic soft pad on the floor and Lie down the whole product to the rear side to the pad carefully . Remove the two front adjustable feet ⑫ ⑭ . Take out the bottom hinge ⑪ from the bottom of right side Record down all the position of the screws on the bottom hinge . Then remove all the screws from the bottom hinge . Turn the hinge over to ensure the protruded area is pointing to the right side . Put the bottom hinge to the bottom of left side and fix all the screws back to the hinge according to the previous record . Then add the two adjustable level feet back to the bottom side .
- 5.Remove the screw from the right side of top hinge plate to left side . Move the unit stand upright . Put the door to the left side . Ensure the hole on the lower side has fully entered to the pin on the bottom hinge plate . Put the top hinge plate , Use the alternative cover (with hole) provided and fit to the side . And fix to the door . Fix the screw to the top hinge plate to the cabinet Turn the door to ensure the door can be open and closed without any problem .
6. Refit the top hinge cover by fixing the screw .



Warning: Please make sure the unit to be tilted more than 45 degree to access the bottom hinge. It is advised to leave the unit for 4 hours to allow the cooling to settle before switch on.

Levelling the appliance

- 1.Rotate feet clockwise to heighten.
- 2.Rotate feet anti clock wise to lower.

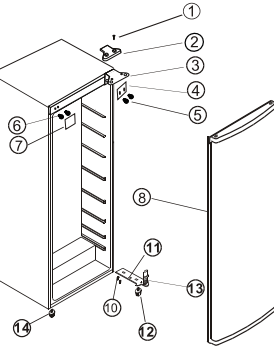

Figure.1

Door opening from left side

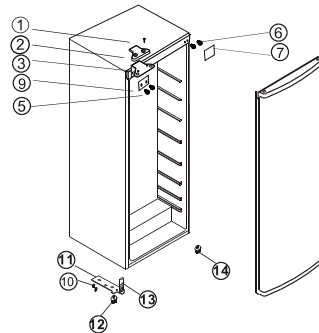
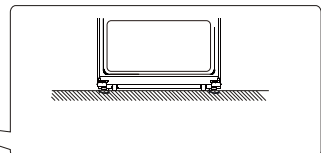

Figure.2

Door opening from right side



Installing your refrigerator

Bringing it all together

Electrical connection



Any electrical work that is required to install this appliance **MUST** be carried out by a qualified electrician.



Warning: THIS APPLIANCE MUST BE EARTHED

Before making any electrical connections, ensure that:

- Electrical safety is only guaranteed when the earth system of your house is in accordance with the related local regulations.
- Do not damage the refrigerant circuit.
- Do not bend, stretch or pull the supply cable to avoid electric shock.
- Do not use electrical appliances inside the food storage compartments of the appliance, unless they are of the type recommended by the manufacturer.
- Ensure the power socket is suitable for the maximum power of the machine (fuses in the power circuit must be 13 amp).
- The supply voltage should be the same as that indicated in the technical specifications and the appliance rating plate.
- The appliance should be earthed and in compliance with the applicable law.
- When installed, the power socket must be within easy reach.
- If the socket outlets in your home are not suitable for the plug supplied with this unit check with a qualified electrician for replacement.
- The use of adapters, multiple connectors or extension cables are not recommended.
- The appliance must be connected to a 220-240 volt 50Hz AC supply by means of a three pin socket, suitably earthed and protected by a 13 amp fuse.
- Should the fuse need to be replaced, a 13 amp fuse approved to BS1362 must be used.
- The plug contains a removable fuse cover that must be refitted when the fuse is replaced. If the fuse cover is lost or damaged, the plug must not be used until a replacement cover has been fitted or the plug is replaced.
- A damaged plug should be cut off as close to the plug body as possible, the fuse should be removed and the plug disposed of safely.

Plug replacement (UK & Ireland only)

Should you need to replace the plug; the wires in the power cable are coloured in the following way:

Blue Neutral 'N'

Brown Live 'L'

Green & Yellow Earth 'E'

As the colours of the wires in the power cable may not correspond with the coloured markings identifying the terminals in your plug, and proceed as follows:

The green & yellow wire must be connected to the terminal in the plug that is marked with the letter E or by the earth symbol.

The blue wire must be connected to the terminal that is marked with the letter N.

The brown wire must be connected to the terminal that is marked with the letter L.

If the power supply cord is damaged, it must be replaced by the manufacturer or its service agent or a similar qualified person in order to avoid a hazard.

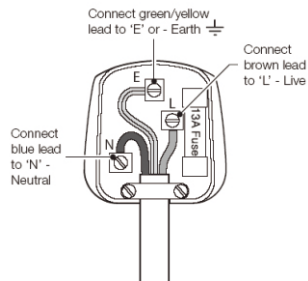

Using your refrigerator 4

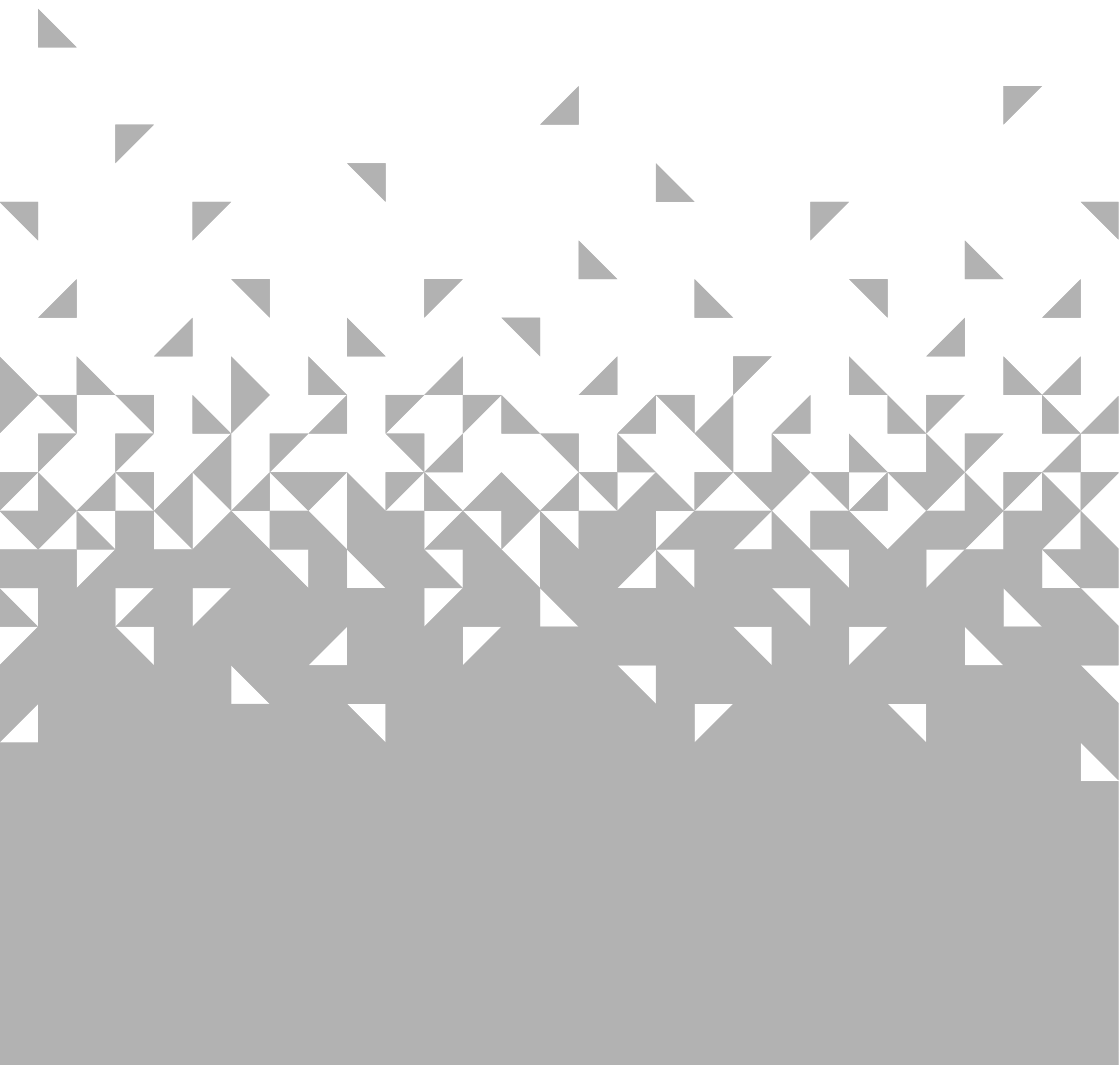

Using your refrigerator

Getting the most from your appliance

Before first use

Final checks before operating the appliance

1. Good air circulation around the appliance positioned.
2. The feet have been adjusted for perfect levelling.
3. Clean the compartment per recommendation in section Care and Maintenance .
4. Plug in the appliance





The compressor starts up and in operation may produce some background noise and it is normal, this is not a defect.

Using your appliance

1. Temperature adjustment

- The compartment temperature can be set by the thermostat between “MIN” and “MAX” (coldest setting). We recommend setting the thermostat midway first.
- To ensure the compartment is maintained at the desired temperature, it is advised to monitor the temperature periodically by a thermometer and adjust the thermostat accordingly.
- Load the appliance after switch on for a while to allow the temperature reach the desired setting.

2. Storing frozen food

- The freezer compartment is  4 Star rated and suitable for the freezing and storage of pre-frozen food.
- Check the food packaging for  suggestion before storage.

Useful information

The following guidelines and recommendations are suggested to obtain the best results and storage hygiene.

- Frequent door openings can cause the internal temperature to rise so the door should be closed as soon as possible.
- For hygiene reasons, it is always a good practise to pack, wrap and cover the food before storing.
- Use a polythene bag to store raw meat and place on the lowest shelf. Avoid contact with cooked food to prevent contamination. For safety reason, store raw meat for two to three days only.
- Cooked dishes must be stored in airtight covered containers.
- Food should cool to room temperature.
- Most vegetables should be blanched and chilled before freezing.
- Do not leave frozen food at room temperature to thaw. You could defrost the food by putting it in the fridge to thaw slowly. Make sure you avoid defrosting food from dropping food juices on to other food.

Position different food in different compartments according to be below table

Freezer drawer(s)/shelf	<ul style="list-style-type: none">• Foods for long-term storage.• Bottom drawer/shelf for raw meat, poultry, fish.• Middle drawer/shelf for frozen vegetables, chips.• Top drawer/shelf for ice cream, frozen fruit, frozen baked goods.
-------------------------	---

Using your refrigerator

Getting the most from your appliance

Energy saving tips

- Place your fridge away from direct sunlight, your oven or any other heat sources. Allow 20 cm clear space on both sides and above, and at least 5 cm behind.
- Cover all food stored, and arrange it so that cold air can circulate freely.
- Higher cold setting will use more energy. Do not set to maximum cold if it is not necessary.
- Cool the hot/warm food to room temperature before put them into your fridge.
- Frequently opening and closing the door will cause the internal temperature to rise and it will consume more energy.
- Close the door(s) properly, and make sure the seals and hinges are airtight. Check the seals by putting a sheet of paper between the door and the main body of the fridge. If the paper moves, your seals need replacing.
- Defrost regularly if your refrigerator is not a frost-free or cyclic defrost model. Accumulated ice layer should not be more than 5 mm thick.
- The pre-set combination of drawers, baskets and shelves have already been set in the most efficient way for the use of this product.

Defrosting

- The appliance requires defrosting once or twice a year when the ice layer thickness 5~10mm. Unplug the appliance from the mains before defrosting.
- Remove all frozen food from the freezer and roll it firmly in newspapers. Put it into a container in a cool place for temporary storage.
- Use an ice scraper (not provided) or similar tool to remove the ice layer. This process can be speeded up by placing a pot
- Empty the defrosting water and clean the freezer.
- Turn on the freezer and set to maximum temperature. Re fill the frozen food to freezer.
- This process should be completed within 2 hours.

Using your refrigerator

Getting the most from your appliance

Temperature setting recommendation

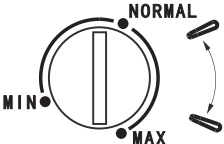
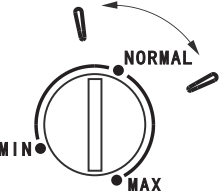
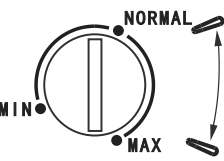
Temperature Setting Recommendation		
Environment Temperature	Freezer compartment	Fridge compartment
Summer (Above 38°C)		/
Normal		/
Winter (Below 16°C)		/

Recommended storage time

- Under Recommended setting, the best storage time of freezer is no more than 1 month.
- The best storage time may reduce under other settings.

Tips for Storing Foodstuffs

- The quantity of fresh food that can be kept frozen in a specific time period is indicated on the rating plate.
- Load limits are determined by baskets, flaps, drawers, shelves etc. Make sure that these components can still close easily after loading.

or online at www.argos-support.co.uk If you still require further assistance, call one of our experts on 0345 257 7271.

Care and Maintenance

5

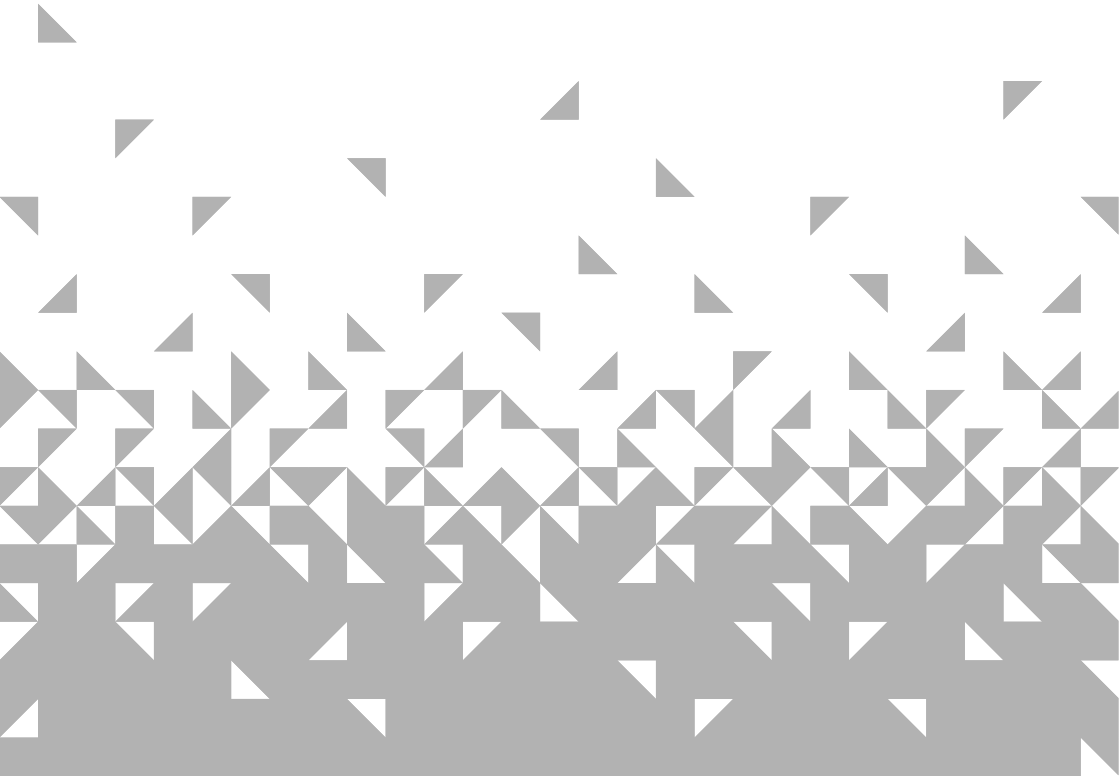

Care and maintenance

Looking after your appliance

General



Important: Always unplug the appliance from the power socket during cleaning and maintenance.

- Never use any sharp instruments or abrasive substances, soap, household cleaner, detergent or wax polish for cleaning.
- Use luke warm water to clean the cabinet of the appliance and wipe it dry.
- Never clean the appliance with flammable fluids. It could cause damage and a fire hazard.
- Clean the exterior of the appliance and door seal with a damp cloth and dry it through.
- Avoid water going into the temperature control box.. Clean with a dry cloth only.
- Clean the condenser (located at the back of the appliance) with a vacuum cleaner. It is suggested to remove the dust every year.
- Shelves are all removable for cleaning purpose.



Important: Care must be taken while cleaning/carrying the appliance not to touch the bottom of the condenser metal wires at the back of the appliance, as this could cause injury to fingers and hands.

Power failure

In case there is a power failure, you should take the following actions:

If it lasts less than 24 hours, keep the doors closed. This will allow the stored food to stay cold as long as possible. If it lasts more than 24 hours, it is advised to empty the freezer compartment and temporarily store the food in a portable freezer or using artificial ice packs. Try to stay cold for as long as possible.

Remarks: Full appliance will stay cold longer than a partially filled one. If ice crystals are still visible on the food, it may be frozen again, although flavour and aroma may be affected. If food is found to be in a poor condition, it is best to throw it away.

Short vacation

There is no need to disconnect the appliance from the mains if you will be away for two to three weeks. Use up the perishable food.

Long vacation

Remove all the food if you are away for three weeks or more. Unplug the appliance and leave the doors open to provide air circulation to prevent odour and mould.

Moving your appliance

Moving

Refer to section Transportation under Installation

Care and maintenance

Looking after your appliance

Technical Specifications

Model	ME60170TFW
Energy efficiency class	F
Energy consumption Kwh/year	267
Net storage volume fresh food (litres)	/
Net storage volume frozen food (litres)	242
Total net storage (litres)	242
Frozen food compartment rating	4star 
Climate class	N/ST
Operating noise level dB(A)	40
Minimum Operation Temperature	16 °C
Product Dimension	600mmx600mmx1700mm

The model information can be retrieved using the QR-Code reported in the energy label.

The label also includes the model identifier that can be used to consult the portal of the registry at <https://eprel.ec.europa.eu>

This product contains a light source of energy efficiency class G (if present).

Disposal information



The symbol on the product or its packaging indicates that this product may not be treated as household waste. Instead it should be handed over to the applicable collection point for the recycling of electrical and electronic equipment. By ensuring this product is disposed of correctly, you will help prevent potential negative consequences for the environment and human health, which could otherwise be caused by inappropriate waste handling of this product. For more detailed information about recycling this product, please contact your local council office, your household waste disposal service or the shop where the product was purchased.

Remember : Old fridges must be disposed of carefully - older models contain CFC gases that are harmful - if in doubt , contact your local council for details on how to dispose of an old fridge .

Doors and lids of the refrigeration appliance should be removed before disposal in the landfill, to avoid children or animals getting trapped inside.

Product support 6

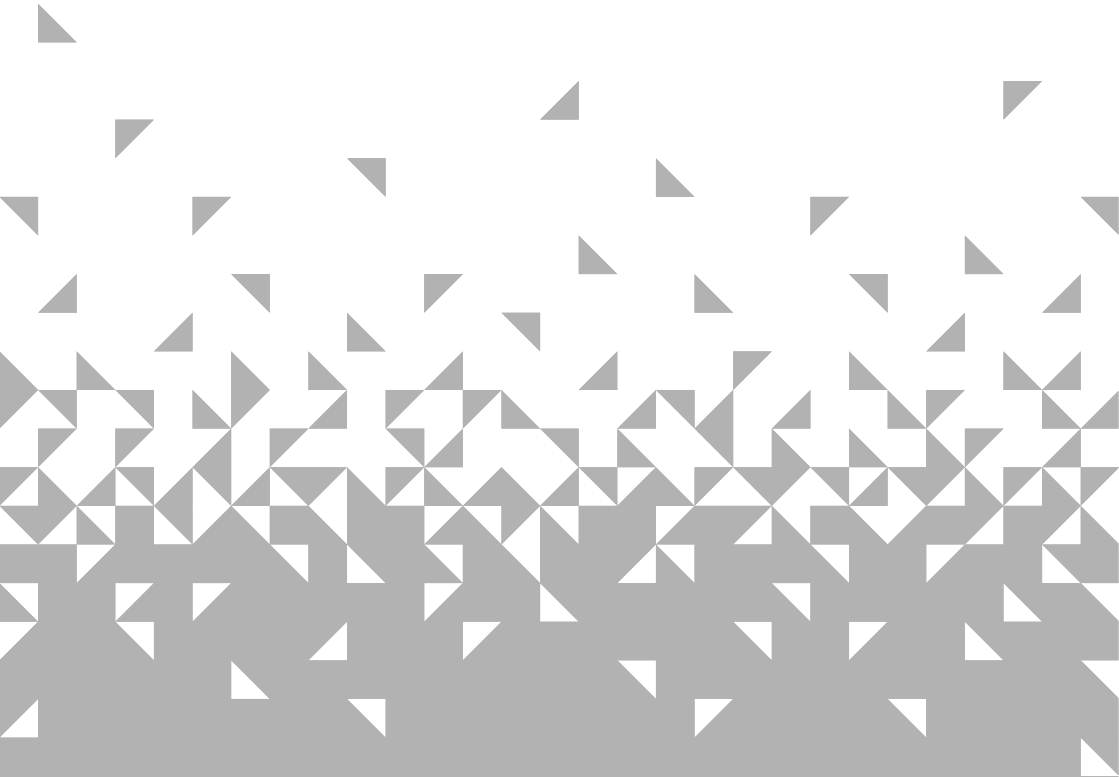

Product support

Help is always at hand

Troubleshooting

If you have a problem with your product, these questions may be able to assist you?

Question- Appliance does not work.

Answer

Appliance is not switched on - Switch on the appliance.

Mains plug is not plugged in or is loose. -Insert mains plug.

Fuse has blown or is defective - Check fuse, replace if necessary.

Socket is defective - Mains malfunctions are to be corrected by an electrician.

Question - Appliance cools too much.

Answer

Temperature is too cold - Adjust the thermostat dial to a warmer setting.

Question - The food is too warm.

Answer

Temperature is not properly adjusted - Adjust the thermostat to a cooler setting.

Door was open for an extended period - Open the door only as long as necessary.

A large quantity of warm food was placed in the appliance - Adjust the thermostat to a cooler setting. Cool warm food before placing in the refrigerator.

The appliance is near a heat source - Position the refrigerator away from a heat source.

Question-Heavy build up of frost, possibly also on the door seal.

Answer

Door seal is not air tight - Carefully warm the leaking sections of the door seal with a hair dryer(not hotter than approx 50 degree). At the same time shape the warmed door seal by hand such that it sits correctly.

Question - Water on the floor or on storage shelves.

Answer

Water drain hole is blocked - Remove food residue or ice from the entrance of the drain hole.

Question - Appliance is making unusual noises

Answers

Appliance is not level - Readjust the front levelling feet.

Appliance is in contact with wall or other objects. - Push appliance away a short distance

A part at the back of the appliance eg a tube, is in contact with another appliance part or wall - Gently bend this part away carefully if necessary

Product support

Help is always at hand

Help and assistance

If you require any technical guidance or find that your refrigerator is not operating as intended a simple solution can often be found in the **Troubleshooting** section of these instruction or online at www.bush-support.com

If you still require further assistance call one of our experts on **0345 257 7271**. To help give us give you a fast and efficient service please have the following information ready.

Model Ref.

You can find these on the rating plate—a small information panel usually a sticker or metal plate on the rear of your appliance

Serial number

Date of purchase

This will be shown on your receipt

Local call rates applies*

Line open 8am-7pm Monday to Saturday and 10am-4pm Sunday

*Calls to Bush enquiry lines may attract a charge and set up fee from residential lines depending on your call plan/tariff. Mobile and other providers costs may vary, see www.bt.com/pricing for details.

For security and training purpose telephone calls to and from customer service centres maybe recorded and monitored. Call from Republic of Ireland will attract international call charges.



This appliance complies with the following EEC directives:
2014/35/EEC Low voltage directive
2014/30/EU EMC directive

Product support

Help is always at hand

BUSH

Call us now and activate your 12 month guarantee

Thank you for choosing Bush. Your new product is guaranteed against faults and breakdowns for 12 months. Don't forget to register it with us today so we can provide you with our best possible after-sale service and useful updates.

www.bushregistration.co.uk

FREEPHONE*

0800 597 8548

Lines are open 8am-8pm, 365 days a year. *Call may be recorded and monitored.

Your Bush Guarantee

This product is guaranteed for twelve months from the date of original purchase. Any defect that arises due to faulty materials or workmanship will be repaired free of charge (or if applicable the product will be replaced or the purchase price refunded where possible during this period by the dealer from who your purchased unit.

The guarantee is subject to the following provisions

- The guarantee does not cover accidental damage misuse cabinet parts, knobs or consumable items.
- The product must be correctly installed and operated in accordance with the instructions contained in the manual
- It must be used solely for domestic purposes. The guarantee will be rendered invalid if the product is re-sold or has been damaged by inexpert repair.
- Specifications are subject to change without notice.
- Bush disclaim any liability for loss or damage arising from the breakdown of the product
- This guarantee is in addition to and does not diminish your statutory or legal rights

Important Data Protection Information

To find out how we and Domestic & General Insurance Plc use your data please refer to the guarantee registration material or visit www.bushregistrations.co.uk

Product support

Help is always at hand

Spare Parts Supply

To order spare parts, please contact our customer helpline: 0345 257 7271. The original spare parts for some specific components are available for a minimum of 7 or 10 years, based on the type of component, from the placing on the market of the last unit of the model.

BUSH

A decorative graphic consisting of numerous small, light gray triangles scattered across the white background. The triangles are oriented in various directions, creating a dynamic, abstract pattern that becomes denser towards the bottom of the page.

Contact

www.bush-support.com

Helpline: 0345 257 7271

CKBSH-D02-M