

# Tefal®

EN

## Fasteo



[www.tefal.com](http://www.tefal.com)

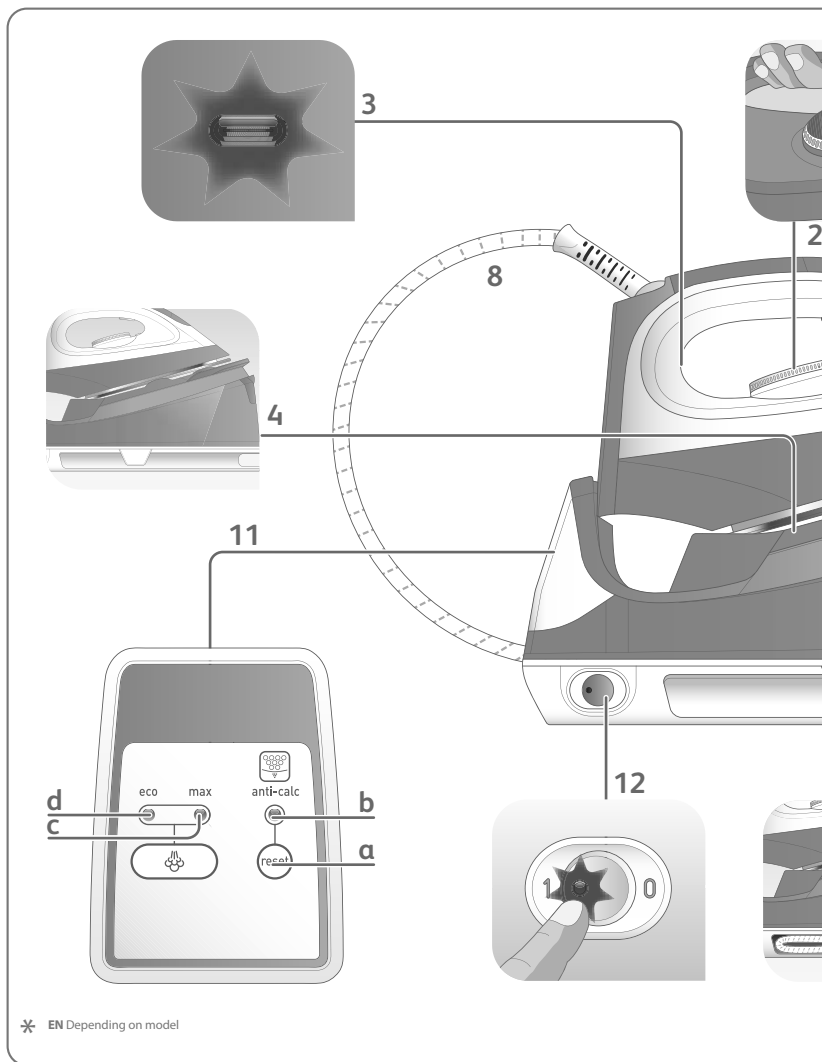

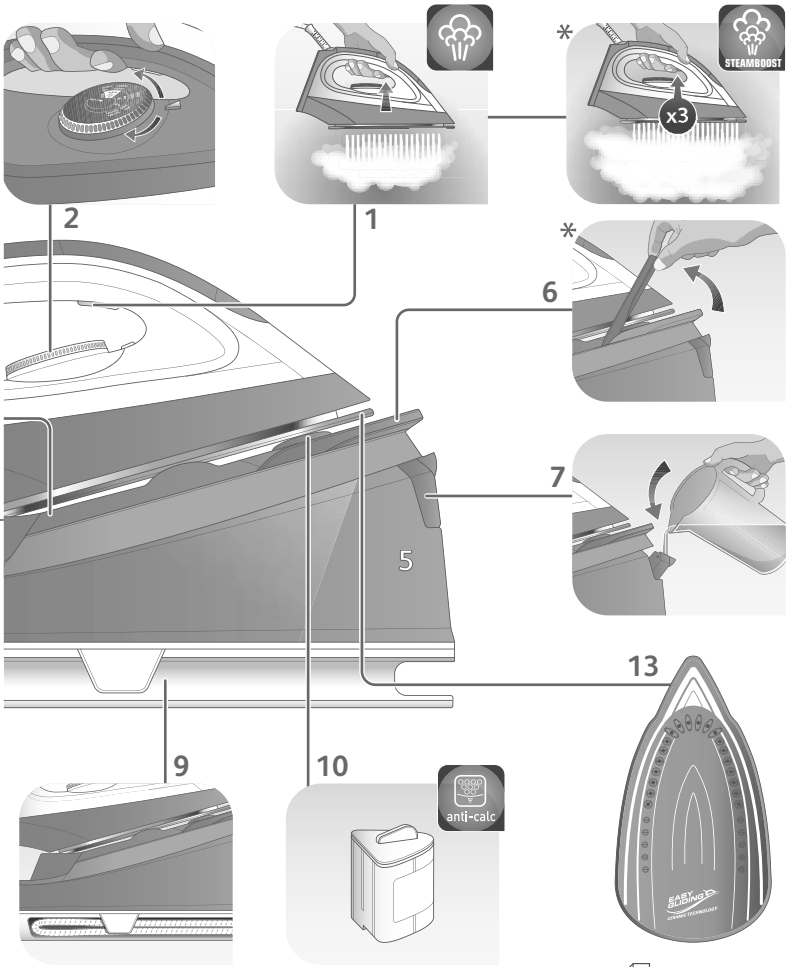

1.



www.tefal.com

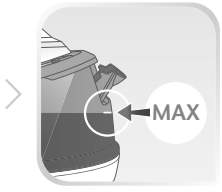
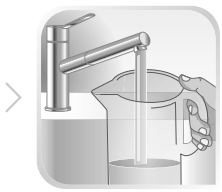
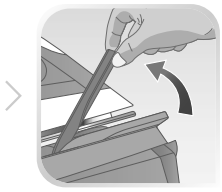

\* EN Depending on model



1.



  
[www.tefal.com](http://www.tefal.com)

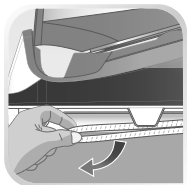

2.



**ON**

  
[www.tefal.com](http://www.tefal.com)

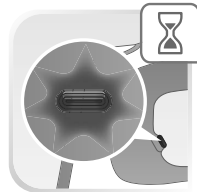
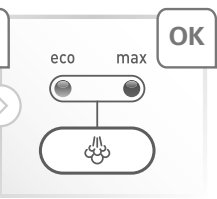
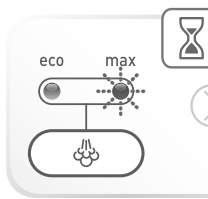
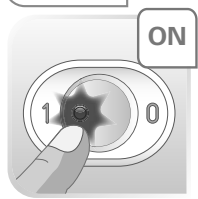

2.

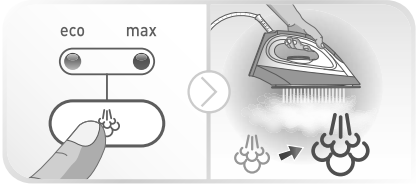
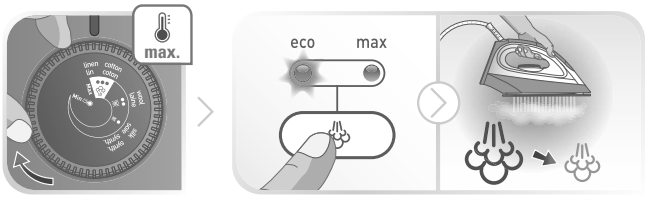



2.



[www.tefal.com](http://www.tefal.com)

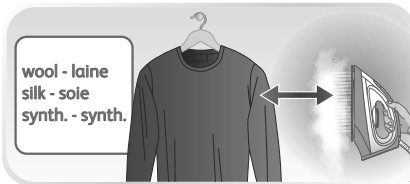
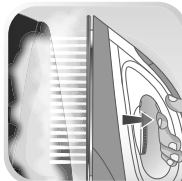
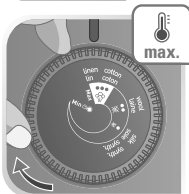

2.



[www.tefal.com](http://www.tefal.com)

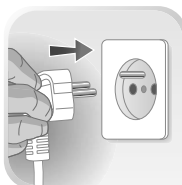
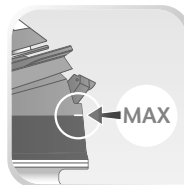
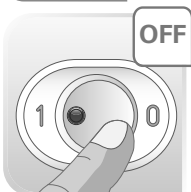

3.

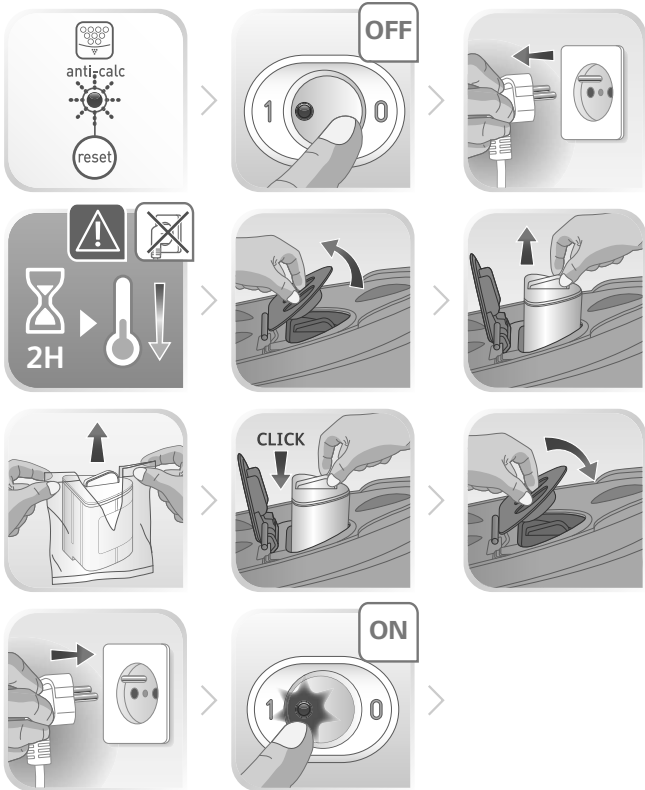

3.



www.tefal.com

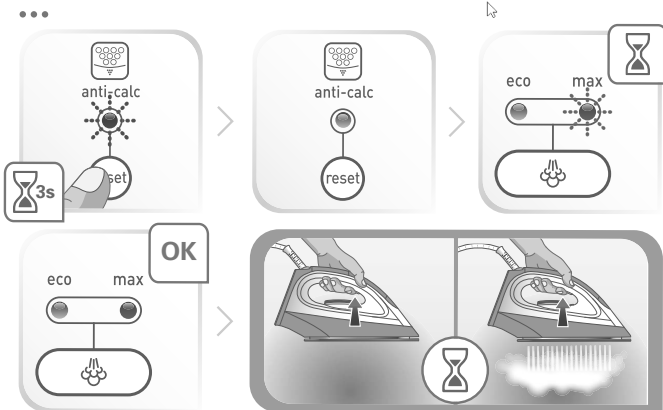

OFF

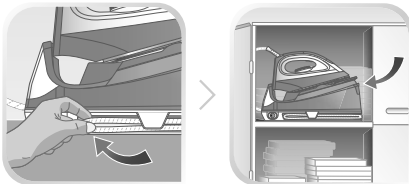
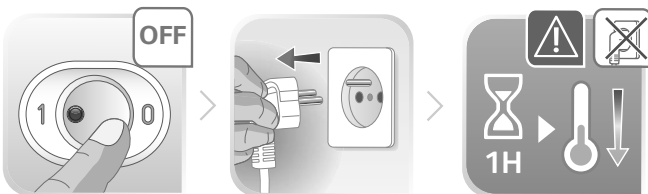

3.



[www.tefal.com](http://www.tefal.com)





EN

# Important recommendations

## Safety instructions

- Please read these instructions carefully before first use. This product has been designed for domestic indoor use only. Any commercial use, inappropriate use or failure to comply with the instructions, the manufacturer accepts no responsibility and the guarantee will not apply.
- Never unplug the appliance by pulling the power cord. Always unplug your appliance:
  - before filling the water tank.
  - before cleaning the appliance,
  - after each use.
- The appliance must be used and placed on a flat, stable, heat-resistant surface. When you place the iron on the iron rest, make sure that the surface on which you place it is stable.
- This appliance is not intended to be used by persons (including children) with reduced or impaired physical, sensory or mental capabilities or persons lacking appropriate knowledge or experience, unless a person responsible for their safety provides either supervision or appropriate instructions concerning use of the appliance prior to its use.
- Children should be supervised to ensure they do not play with the appliance.
- This appliance may be used by children aged 8 or over and persons lacking appropriate knowledge or experience or persons with reduced or impaired physical, sensory or mental capabilities provided that they have been thoroughly instructed regarding the

use of the appliance, are supervised, and understand the risks involved. Children shall not play with the appliance. Cleaning and user maintenance shall not be made by children without supervision. Keep the iron and its cord out of reach of children less than 8 years of age when it is in use or cooling down.



- The surfaces of your appliance marked by this symbol can reach very high temperatures when functioning, which may cause burns. Do not touch the hot surfaces of the appliance (accessible metal parts and plastic parts adjacent to the metallic parts) until the appliance has completely cooled.
  - Never leave the appliance unattended when it is connected to the mains. Before storing the appliance, once it is unplugged, please wait until it has cooled down (around 1 hour).
  - Never fill your appliance directly from the tap.
  - The cartridge cap must not be opened during use.
  - The appliance must not be used if it has been dropped, if it has any visible damage, if it leaks, or if it functions abnormally in any way. Do not attempt to dismantle your appliance: have it examined at an Approved Service Centre to avoid any danger.
  - Check the electrical power cord and water connection cord for signs of wear or damage prior to use. If the electrical power cord or the water connection cord is damaged, it must be replaced by an Approved Service Centre to avoid any danger.
- For your safety, this appliance conforms to all applicable regulations (Low Voltage Directive, Electromagnetic Compatibility, Environment, etc).
  - Your appliance is an electrical appliance: it must be used under normal conditions of use. It is designed for domestic use only.
  - It is equipped with a thermal fuse to avoid overheating.
  - Always plug your appliance:
    - into a mains circuit with voltage between 220 V and 240 V (Alternating current only),
    - a socket outlet with an earth connection.

Connecting to the wrong voltage may cause irreparable damage to the appliance and will invalidate your guarantee.

If you are using a mains extension lead, ensure that it is correctly rated (16A) with an earth connection, and is fully extended. Always ensure that the base unit is positioned close enough to the ironing surface to avoid straining and premature wear of the water connection cord.

- Completely unwind the power cord before plugging into an earthed socket outlet.
- Do not leave the power or water connection cords close to or in contact with sources of heat or sharp edges.
- The sole plate of your iron and the iron rest on the base unit and cartridge cap can reach extremely high temperatures, and can cause burns: do not touch them. Never touch the electrical power cords with the sole plate of the iron.
- Always use a vented/mesh ironing board to prevent water spots on clothes and to avoid hot steam venting sideways. Be careful of hot steam when ironing close to the edges of the board. Never iron in a seated position with your legs under the ironing board.
- Your appliance emits steam, which can cause burns. Always handle the iron with care, especially when ironing vertically. Never direct the steam towards people or animals.
- Never immerse your appliance in water or any other liquid. Never place it under a running tap.



- The first time the appliance is used, there may be some fumes and smell but this is not harmful. If you use the appliance for the first time, if you have replaced the anti calc cartridge or after filling the water tank, press the steam control button continuously for few minutes pointing it away from your linen, in order to prime the pump and obtain steam.

- When in use, the electric pump injects water into the iron soleplate. It makes a noise but this is normal.
- Safety instructions Anti calc cartridge:



- Not for drinking



- Keep out of the reach of children



- Dispose with household refuse



- Keep in cool dry place

## Preparation

### What water may be used ?

This appliance has been designed to be used with untreated tap water.

Types of water not to use: In order to prevent your appliance life, you should not use water from clothes dryers, scented or softened water or water with additives, water from refrigerators, batteries, air conditioners, rain water, boiled, filtered or bottled water. Do not use pure distilled nor pure demineralised water.

All the types of water listed above may contain organic waste, mineral or chemical elements that can cause spitting, brown staining or premature wear of the appliance.

Do not fill the water tank from the cartridge compartment.

## Cartridge

### Anti calc maintenance

Do not put any descaling substances (vinegar, industrial descaling products, etc.) in the water tank or in the anti calc compartment, they could damage your appliance.

Using the appliance without changing the cartridge can damage the appliance and stop its steaming performance. Press on the anti calc button only if you have changed the cartridge.

To ensure the efficiency of the cartridge, please remove it from its plastic bag and remove the cap just before use. The international guarantee will not cover any damages which occurs as a result of using the appliance without changing the cartridge

# PLEASE RETAIN THIS INSTRUCTION BOOKLET FOR FUTURE REFERENCE

## EN • PLEASE REFER TO SAFETY INSTRUCTIONS AT THE BEGINNING OF THIS BOOKLET BEFORE USING YOUR APPLIANCE

### Description

- |   |   |
|---|---|
| <ol style="list-style-type: none"> <li>1. Steam control button</li> <li>2. Iron temperature control dial</li> <li>3. Iron thermostat light</li> <li>4. Iron rest plate</li> <li>5. Water tank</li> <li>6. Lock system (depending on model)</li> <li>7. Water tank refill inlet</li> <li>8. Water connection cord</li> <li>9. Water connection cord storage compartment</li> </ol> | <ol style="list-style-type: none"> <li>10. Anti Calc cartridge</li> <li>11. Control panel               <ol style="list-style-type: none"> <li>a. Reset Anti-calc button</li> <li>b. Anti-calc indicator</li> <li>c. Max steam mode and steam ready indicator</li> <li>d. ECO steam mode indicator</li> </ol> </li> <li>12. Illuminated on / off switch</li> <li>13. Soleplate</li> </ol> |
|---|---|

### Locking system (depending on model)

Your appliance is fitted with a retaining hoop to hold the iron onto the base with a locked position for easy transport and storage:

#### • Locking. • Unlocking.

To transport your appliance using the handle of the iron:

- Put the iron on the iron rest plate and raise the retaining hoop over the iron until it locks into place.
- Hold the iron by the handle to transport your appliance.

### Preparation

#### What water may be used ?

This appliance has been designed to be used with untreated tap water.

Types of water not to use: In order to maintain your appliance life, you should not use water from clothes dryers, scented or softened water or water with additives, water from refrigerators, batteries, air conditioners, rain water, boiled, filtered or bottled water.

All the types of water listed above may contain organic waste, mineral or chemical elements that can cause spitting, brown staining or premature wear of the appliance.

If your water is very hard, we recommend you use a mix of 50% untreated tap water and 50% distilled water available in hardware stores.

Do not use pure distilled nor pure demineralised water.

Do not fill the water tank from the cartridge compartment.

#### Filling the water tank

- Place your iron on a flat, stable, horizontal surface that is heatproof and waterproof.
- Always ensure that the base unit is positioned close enough to the ironing surface to avoid straining and wear of the cord.
- We recommend that you use a mesh type ironing board to allow steam to pass through the garments for better ironing results and also to prevent steam venting sideways.
- Check that your appliance is unplugged and open the refill inlet cover on the front of the water tank.
- Fill the water tank with untreated tap water until the max level.
- Close the water tank refill inlet cover.
- **Do not fill the water tank from the cartridge compartment.**
- This appliance is designed to be used with a cartridge.

#### Using your appliance

The first time the appliance is used, there may be some fumes and smell but this is not harmful. They will not affect use and will disappear rapidly.

- Completely unwind the power cord and the water connection cord.
- Plug in your appliance to an earthed socket.
- Press on the on / off switch. The max indicator located on the control panel flashes while the iron heats up. When the max indicator light stops flashing and the iron thermostat light goes out (after 2 minutes approximately), the appliance is ready for use.
- **If you use the appliance for the first time, if you have replaced the anti calc cartridge or after filling the water tank, press the steam control button continuously for a few minutes pointing it away from your linen, in order to prime the pump and obtain steam when the temperature dial is in the 3 dot position.**

- When in use, your electric pump injects water into the iron soleplate. It makes a noise but this is normal.

## Use





### Setting the temperature

Do not place the iron on a metal support. When taking a break from ironing, always place the iron on the iron rest plate of the unit. It is equipped with non-slip pads and has been designed to withstand high temperatures.

- Place the iron's temperature control dial according to the type of fabric to be ironed (see table below).
- The iron thermostat light comes on. Important: whenever you start using your iron and whenever you change the temperature during use, the iron is fully ready for use when its iron thermostat light goes out.
- While ironing, the light of the iron turns on and off, as the temperature adjusts without interrupting ironing.
- Steam may take some time to start as your appliance needs to activate its water circuit.
- The steam can only be used on 3 dots setting area (see below table). For other garments (1 dot and 2 dots) the iron is not hot enough to produce steam and therefore it is not recommended to use the steam control button as this may cause water dripping from the soleplate.
- The steam will stop when you release the button.
- Always spray starch onto the reverse side of the fabric to be ironed.

Before using the iron for the first time, or if you have not used the steam button for a long time, press the steam control button several times in a row, holding the iron away from your clothes.

#### • Iron temperature setting:

SETTING THE TEMPERATURE AND STEAM OUTPUT ACCORDING TO TYPE OF FABRIC TO BE IRONED		
TYPE OF FABRICS	Setting temperature control	
Synthetics, Silk	●	
Wool, Viscose	●●	
Linen, cotton	●●●	 

- Start with the fabrics to be ironed at a low temperature (●) and finish with those which need higher temperatures (●●● or Max).
- Mixed fibre fabric: set the ironing temperature to the setting for the most delicate fabric.
- If you put your thermostat in the "min" position, the iron does not heat.

### Steam boost function

- Your appliance includes the Steam boost: automatic sequential steam for effortless use. To be used in particular for thick fabrics.
- To obtain this function, press the steam control button under the handle three times in quick succession.

ECO MODE: Your appliance has an ECO mode function which uses less power whilst still producing a good steam flow to iron your garments properly. This mode can only be used on 3 dots setting (●●● or Max) (see Above table).

### Dry ironing

- Do not press the steam control button under the iron handle.

### Vertical steam ironing

Recommendations : for fabrics other than linen or cotton, hold the iron a few centimetres from the garment to avoid burning the fabric.

- Set the iron temperature control dial to the MAX position.
- Hang the garment on a coat hanger.

**As steam is very hot : never attempt to remove creases from a garment while it is being worn, always hang garments on a coat hanger.**

- Holding the iron in a vertical position, press repeatedly on the steam control button (underneath the iron handle) moving the iron from top to bottom.

## Refilling the water tank

- The water tank is empty.
- Switch off then unplug the appliance and open the flap on the tank.
- Fill a jug with untreated tap water then fill the tank up to the max mark.
- Plug in and switch the appliance on again by pressing the on/off switch.

## Maintenance and cleaning

### Anti calc maintenance

Do not put any descaling substances (vinegar, industrial descaling products, etc.) in the water tank or in the anti calc cartridge compartment, they could damage your appliance.

To extend the life of your appliance and to avoid scale, your appliance is equipped with a anti calc cartridge system. This anti calc cartridge system is located below the iron rest.

The cartridge will need to be changed only when the anti-calc indicator flashes which will depend on your frequency of ironing and how much steam you use.

Operation:

The appliance has an anti calc indicator located on the control panel. When this indicator is flashing it means that the anti calc cartridge is no longer efficient and must be replaced by a new one.

To replace your anti calc cartridge :

- Never replace the anti calc cartridge during use.
- Switch off and unplug your appliance.
- Wait for at least one hour and check that the appliance is cold.
- Open the anti calc cartridge cover.
- Pull the used anti calc cartridge out of its compartment.
- Be careful, some water drops may fall out of the anti calc cartridge when you remove it from its compartment. This is normal and the water is harmless.
- Take the new anti calc cartridge out of its bag.
- Place the new anti calc cartridge in the compartment and press it down until it locks.
- Close the anti calc cartridge cover.
- Plug and switch on your appliance. The max indicator located on the control panel flashes while the iron heats up. When the max indicator light stops flashing and the iron thermostat light goes out (after 2 minutes approximately), the appliance is ready for use.
- Press the anti calc reset button on the control panel. (3 seconds)
- You might have to press the steam control button for a few minutes to start the steam again as your appliance needs to re-activate its water circuit when the temperature dial is in the 3 dot position.

This operation is essential to maintain the working life of your appliance.

**Using the appliance without changing the cartridge can damage the appliance and stop its steaming performance. Press on the anti calc button only if you have changed the cartridge.**

**To ensure the efficiency of the cartridge, please remove it from its plastic bag just before use. The international guarantee will not cover any damages which occur as a result of using the appliance without changing the cartridge.**

### Cleaning your appliance

Before cleaning, ensure your appliance is unplugged and that the soleplate and the iron have cooled down for least 1 hour.

- Do not use detergent or descaling products for cleaning the soleplate base-unit.
- Never hold the iron or the base unit under the tap.
- Regularly clean the soleplate with a damp, non-metallic washing up pad.
- Clean the plastic parts of the appliance occasionally with a soft cloth.

### Storing your appliance

- Warning: do not touch the soleplate while still hot.
- Store the water connection cord in its compartment.
- Leave the iron (and the iron rest) to cool down for 1 hour before storing it away.

## A problem with your appliance ?

PROBLEMS	CAUSES	SOLUTIONS
Your iron is producing little or no steam.	You have just filled the tank or changed the anti-calc cartridge, or you have just started using it.	Press the steam control button continuously for few minutes pointing it away from your linen, in order to prime the pump.
	There is no anti calc cartridge in the appliance or it is not properly installed.	Make sure the anticalc cartridge is installed and locked down in its compartment.
	Steam cannot be produced at the temperature you have selected.	Set the thermostat control in the coloured zone (••• or MAX).
	The water tank is empty.	Fill the tank.
Water runs out of the holes of the soleplate.	You are using steam for the first time or you have not used it for some time.	Press on the steam control button away from your ironing board until the iron produces steam.
	The setting is not correct (1 dot / 2 dots) and the soleplate is not hot enough to produce steam.	Set the iron at 3 dots (••• or MAX) and wait for the iron thermostat light to go out before activating the steam button again.
Water streaks appear on the linen.	Your ironing board is saturated with water because it is not suitable for use with a steam generator.	Check that your ironing board is suitable. We recommend that you use a vented/mesh type ironing board.
Brown streaks come through the holes in the soleplate and stain the linen.	You are using chemical descaling agents or additives in the water ironing.	Never add this type of product in the water tank (see "for what water may be used"). Contact an Approved Service Centre.
	Your linen is not rinsed sufficiently or you have ironed a new garment before washing it.	Ensure linen is rinsed thoroughly to remove any soap deposits or chemicals on new garments which may be sucked up by the iron.
The soleplate is dirty or brown and may stain the linen.	You are ironing at too high a temperature.	See our recommendations regarding temperature control setting.
	You are using starch.	Always spray starch on the reverse side of the fabric to be ironed.
Steam or water escapes under the base of the appliance.	The appliance is faulty.	Stop using your appliance and contact an Approved Service Centre.
The "anti calc" indicator is flashing.	The anti calc cartridge is no longer efficient.	Replace the anti calc cartridge with a new one then press the reset button for a minimum of 3 seconds.
The anti calc indicator is still flashing after replacing the cartridge.	You have not pressed the reset button.	Press the reset button until the light stops flashing.

If you have any problems or queries please call our Customer Relations team first for expert help and advice: 0345 602 1454  
UK / (01) 677 4003 - ROI or consult our website - [www.tefal.co.uk](http://www.tefal.co.uk)

### Environment protection first !

- ① Your appliance contains valuable materials which can be recovered or recycled.
- Leave it at a civic waste disposal centre.



