

# BUSH

## Instruction manual

WDSAE86W

WDSAE86B

WDSAE107W

WDSAE107B



You'll soon be enjoying your new washer-dryer.

It all begins here, with your instructions. Don't worry, there's nothing too technical coming up. Just simple, step-by-step guidance to get you up and running quickly. Sound good? Then let's get started.

## Help and Guidance

We're here to help you get the most from your washer-dryer. Should you require any guidance, a simple solution can often be found online at:

**[www.bush-support.com](http://www.bush-support.com)**

If you still require further assistance, call one of our experts on **0345 257 7271**.

If you require any technical guidance or find that your product is not operating as intended, a simple solution can often be found in the **Troubleshooting** section of these instructions,

# Contents

## 1 Safety information

Safety information 6

## 2 Getting to know your washer-dryer

Ready? Let's begin 10

Accessories 12

## 3 Installing your washer-dryer

Installation requirements 14

Unpacking 14

Connections (electrical, water, gas) 15

## 4 Functions

Functions 18

## 5 Using your washer-dryer

First use of washer-dryer 24

Standard and advanced functions/use 25

## 6 Care and Maintenance

Cleaning 30

Maintenance actions 30

Technical specifications 32

## 7 Product support

Troubleshooting 38

Help and assistance 39

Declaration of conformance to product standards 40

Disposal 41



# Safety information

1





## Safety information

**Important** - Please read these instructions fully before installing or operating

- If the supply cord is damaged, it must be replaced by the manufacturer, its service agent or similarly qualified persons in order to avoid a hazard.
- The new hose-sets supplied with the appliance are to be used and the old hose-sets should not be reused.
- This washer-dryer is for indoor use only.
- The openings must not be obstructed by a carpet.
- This appliance can be used by children aged from 8 years and above and persons with reduced physical, sensory or mental capabilities or lack of experience and knowledge if they have been given supervision or instruction concerning use of the appliance in a safe way and understand the hazards involved.  
Cleaning and maintenance shall not be made by children without supervision.
- This appliance is not intended for use by persons (including children) with reduced physical, sensory or mental capabilities, or lack of experience and knowledge, unless they have been given supervision or instruction concerning use of the appliance by a person responsible for their safety.
- Pull out its plug from the power socket before cleaning or maintenance.
- Make sure that all pockets are emptied.
- Sharp and rigid items such as coin, brooch, nail, screw or stone etc. may cause serious damages to this machine.
- Pull out its plug and cut off water supply after the operation.
- Please check whether the water inside the drum has been drained before opening its door. Please do not open the door if there is any water visible.
- Pets and children may climb into the machine. Check the machine before every operation.
- Glass door may be very hot during the operation. Keep children and pets far away from the machine during the operation.
- Take care that power voltage and frequency shall be identical to those required by washer-dryer.
- Do not use any socket with rated current less than that required by washer-drier.  
Never pull out power plug with wet hand.
- To ensure your safety, power cord plug must be inserted into an earthed three-pole socket. Check carefully and make sure that your socket is properly and reliably earthed.

If you require any technical guidance or find that your product is not operating as intended, a simple solution can often be found in the **Troubleshooting** section of these instructions,



## Safety information

**Important** - Please read these instructions fully before installing or operating

- Children of less than 3 years should be kept away unless continuously supervised.
- Do not let kids play with the machine.
- Packing materials may be dangerous to children. Please keep all packing materials (plastic bags, foams etc) far away from children.
- Washer-dryer shall not be installed in bath room or very wet rooms as well as in rooms with explosive or caustic gases.
- Make sure that the water and electrical devices must be connected by a qualified technician in accordance with the manufacturer's instructions and local safety regulations.
- Before operating this machine, all packages and transport bolts must be removed. Otherwise, the washer-dryer may be seriously damaged while washing the clothes.
- Before washing the clothes at first time, the washer-dryer shall be operated in one round of the whole procedures without the clothes inside.
- The washer-dryer with single inlet valve only can be connected to the cold water supply. The washer-dryer with double inlet valves can be connected to the hot water and cold water supply.
- Your washer-dryer is only for home use and is only designed for textiles suitable for machine washing.
- Flammable and explosive or toxic solvents are forbidden. Gasoline and alcohol etc. Shall not be used as detergents. Shall only select the detergents suitable for washer-dryer.
- Be careful of burning when washer-dryer drains hot washing water. Never refill the water by hand during washing.
- After the program is completed, Please wait for two minutes to open the door.
- Please remember to disconnect water and power supply immediately after the clothes are washed.
- Do not climb up and sit on top cover of the machine.  
Do not lean against machine door.
- Please do not close the door with excessive forces. If it is found difficult to close the door, please check if the excessive clothes are put in or distributed well.
- The household washer-dryer isn't intended to be built-in.
- Cautions during Handling Machine
  1. Transport bolts shall be reinstalled to the machine by a specialized person.
  2. The accumulated water shall be drained out of the machine.
  3. Handle the machine carefully.
- Never hold each protruded part on the machine while lifting. Machine door can not be used as the handle during the conveyance.



## Safety information

**Important** - Please read these instructions fully before installing or operating

Cord entanglement hazard. The cable of the appliance can give rise to risks of entanglement, strangulation or tripping if not correctly placed. You must make sure that the electric cable is positioned safely.

If you require any technical guidance or find that your product is not operating as intended, a simple solution can often be found in the **Troubleshooting** section of these instructions,



# Getting to know your washer-dryer

2



# Getting to know your washer-dryer

You'll be up and running in no time

## Ready? Let's begin...

Please read these instructions carefully. They contain important information which will help you get the best from your washer-dryer and ensure safe and correct installation and operation.

If you require any further assistance, our technical experts are happy to help. For full details, refer to the product support section at the end of these instructions.

If you require any technical guidance or find that your product is not operating as intended, a simple solution can often be found in the **Troubleshooting** section of these instructions.

# Getting to know your washer-dryer

You'll be up and running in no time

## Component

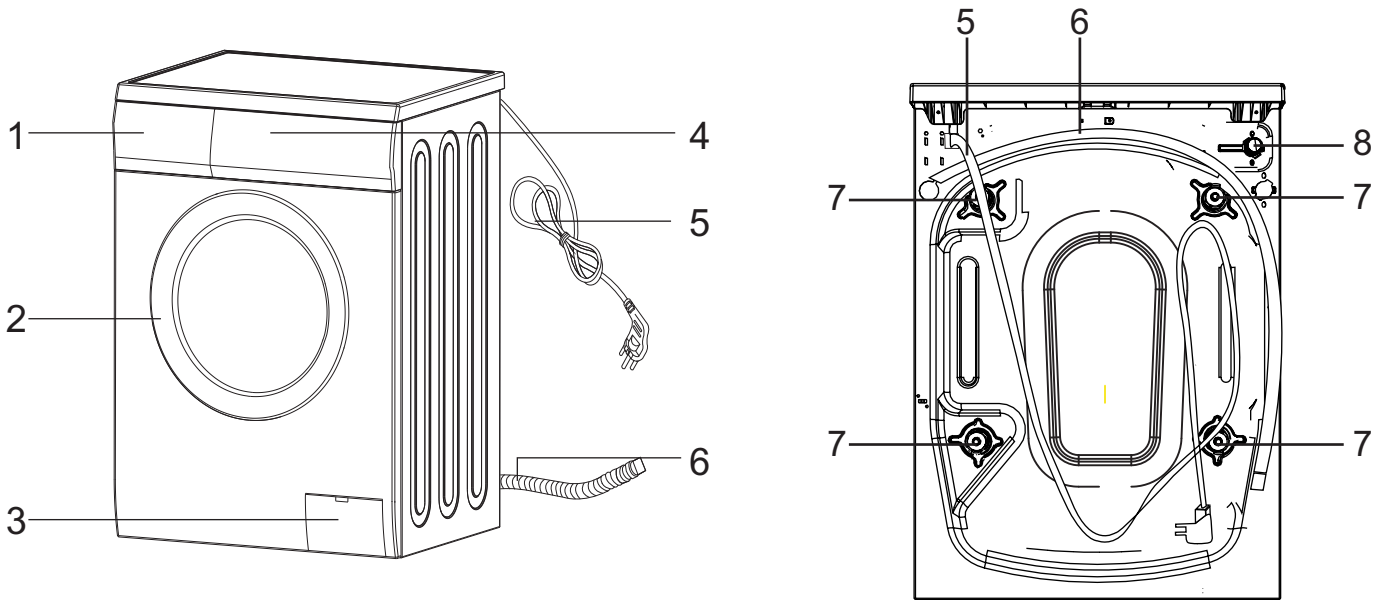

**1.**Detergent Drawer

**2.**Door

**3.**Filter

**4.**Control Panel

**5.**Power lead

**6.**Drain hose

**7.**Transport bolt x 4

**8.**Water inlet

# Getting to know your washer-dryer

You'll be up and running in no time

Model	Capacity		Spin Speed	Energy Class	
	Washing	Drying		Washing	Drying
WDSAE86W	8kg	6kg	1400rpm	B	E
WDSAE86B	8kg	6kg	1400rpm	B	E
WDSAE107W	10kg	7kg	1500rpm	B	D
WDSAE107B	10kg	7kg	1500rpm	B	D

## Accessories

This machine includes below accessories, please install these parts by yourself before operating.

- plastic hole plug x 4
- nlet hose

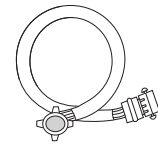
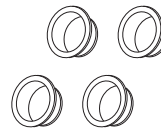

## Tools

You may use this tools to help install above parts

- glove
- spanner

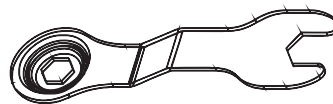

If you require any technical guidance or find that your product is not operating as intended, a simple solution can often be found in the **Troubleshooting** section of these instructions.

# Installing your washer-dryer

3



# Installing your washer-dryer

## Bringing it all together

### Installation requirements

- In addition to the instructions mentioned here, special regulations of the relevant water companies may apply. If in doubt, have the washer-dryer connected by a qualified technician.
- The washer-dryer is heavy - caution when lifting it.
- Do not lift by projecting components (e.g. washer-dryer door).
- Warning: Frozen hoses may tear/burst. Do not install washer-dryer in outdoor areas or where there is a risk of frost. Please operate washer-dryer above 0°C.
- Lay hoses and cables in such a way that there is no risk of tripping over them.

 An additional space (approximately 120mm) is required at the rear of the washer-dryer. This is to allow enough space for the water hose and drain hose connections.

- Dimension of the machine with door open.

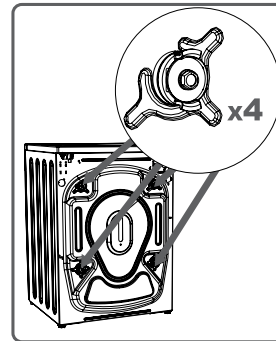
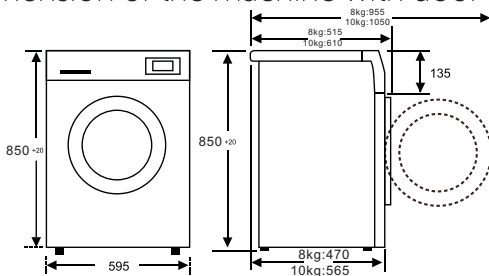

Fig 1

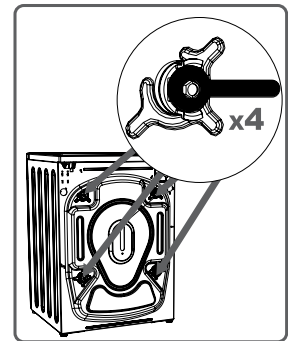

Fig 2

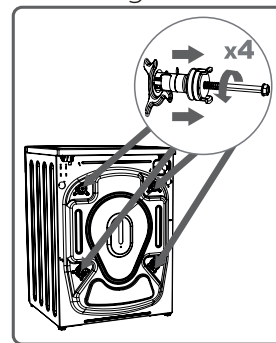

Fig 3

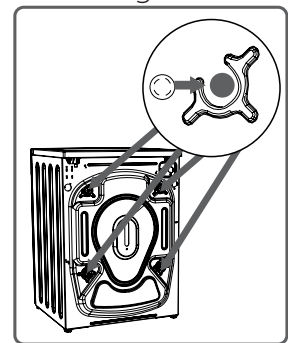

Fig 4

### Levelling feet

**1:** For your machine to work efficiently with minimum vibration it should be settled on flat, nonslippery, firm ground.

**2:** You can adjust the balance of your machine by changing the positioning of its feet.

**3:** First, loosen the plastic adjustment nut. (Fig 5)

**4:** Adjust by rotating the feet upwards or downwards. (Fig 6)

**5:** After the desired position has been reached, tighten the plastic adjustment nut again by rotating it upwards.

Note: Never put cartons, wooden blocks or similar materials under the machine to balance irregularities in the level of the ground.

### Unpacking

Unpacking your washer-dryer

Caution: 2 people are required to unpack the washer-dryer, it is recommended that gloves are worn.

Carefully remove all packing materials including the foam base, dispose of correctly.

Note: When opened, water droplets may be visible in the drum etc. this is normal as each appliance is tested before delivery.

### Removing the transport bolts

Important: The transport bolts are designed to support the internal components during transit these **MUST** be removed before use.

**1:** Loosen the screws by rotating counterclockwise with a suitable wrench. (Fig 1, 2)

**2:** Remove the bolts by pulling them. (Fig 3)

**3:** When the transport bolts have been removed, insert the plastic hole plugs found in the accessories bag into the holes. (Fig 4)

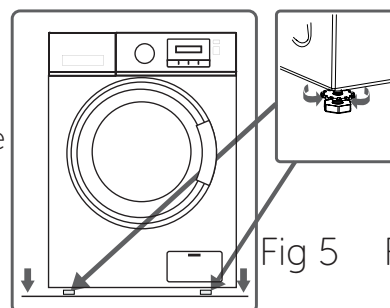

Fig 5

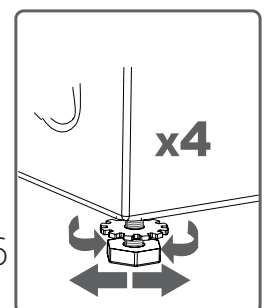

Fig 6

If you require any technical guidance or find that your product is not operating as intended, a simple solution can often be found in the **Troubleshooting** section of these instructions.

# Installing your washer-dryer

## Bringing it all together

### Connections

#### Water inlet hose connections

Important: This washer-dryer **MUST** only be connected to a cold water supply.

**1:** Connect the water inlet hose, the angled connection attaches to the water inlet on the back of the washer-dryer. (Fig 7)

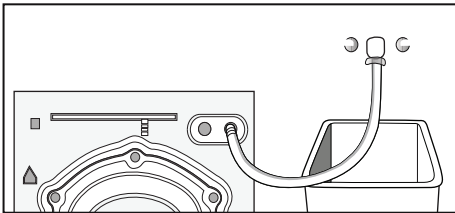

Fig 7

**2:** The straight connection attaches to the water supply valve. (Fig 8)

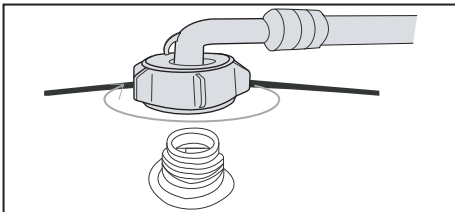

Fig 8

**3:** Ensure all seals are in place before connecting.

Important: Only tighten the hose connection nut by hand - do not overtighten.

#### Drain hose connections

Important: The height of the top of the curve in the drain hose **MUST** be between 60 - 100cm from the floor. (Fig 9)

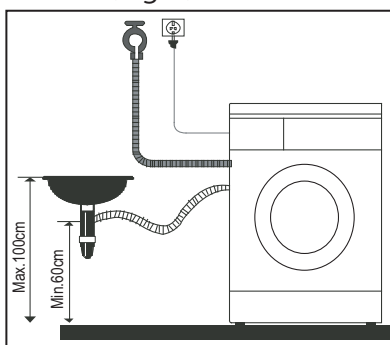

Fig 9

Important: Drain hose can be fitted to the drainer or a wash basin.

### Electrical



Any electrical work that is required to install this appliance **MUST** be carried out by a qualified electrician.



Warning: **THIS APPLIANCE MUST BE EARTHED**

Before making any electrical connections, ensure that:

- Electrical safety is only guaranteed when the earth system of your house is in accordance with the related local regulations.
- Do not bend, stretch or pull the supply cable to avoid electric shock.
- Ensure the power socket is suitable for the maximum power of the machine (fuses in the power circuit must be 13 amp).
- The supply voltage should be the same as that indicated in the technical specifications and the appliance rating plate.
- The appliance should be earthed and in compliance with the applicable law.
- When installed, the power socket must be within easy reach.
- If the socket outlets in your home are not suitable for the plug supplied with this unit check with a qualified electrician for replacement.
- To avoid the risk of overloading your plug socket, the use of adapters, multiple connectors or extension cables are not recommended.
- The appliance must be connected to a 220-240 volt 50Hz AC supply by means of a three pin socket, suitably earthed and protected by a 13 amp fuse.
- Should the fuse need to be replaced, a 13 amp fuse approved to BS 1362/A must be used.
- The plug contains a removable fuse cover that must be refitted when the fuse is replaced. If the fuse cover is lost or damaged, the plug must not be used until a replacement cover has been fitted or the plug is replaced.
- A damaged plug should be cut off as close to the plug body as possible, the fuse should be removed and the plug disposed of safely.

# Installing your washer-dryer

## Bringing it all together

### Plug replacement (UK & Ireland only)

Should you need to replace the plug; the wires in the power cable are coloured in the following way:

Blue - Neutral 'N'

Brown - Live 'L'

Green & Yellow - Earth 'E'

As the colour of the wires in the power cable may not correspond with the coloured markings identifying the terminals in your plug, and proceed as follows (Fig 10):

The green & yellow wire must be connected to the terminal in the plug that is marked with the letter E or by the earth symbol.

The blue wire must be connected to the terminal that is marked with the letter N.

The brown wire must be connected to the terminal that is marked with the letter L.

If power supply cord is damaged, it must be replaced by the manufacturer or its service agent or a similar qualified person in order to avoid a hazard.

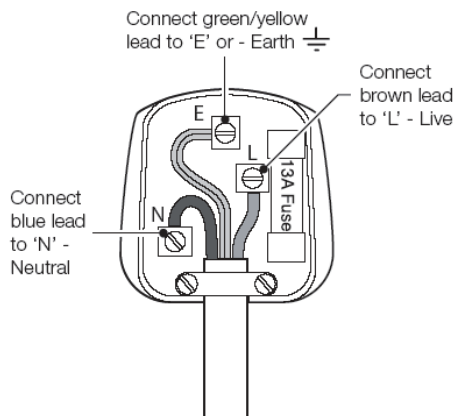

Fig 10

If you require any technical guidance or find that your product is not operating as intended, a simple solution can often be found in the **Troubleshooting** section of these instructions.



# Functions 4



# Functions

## Simple everyday use

### Introduction of control panel

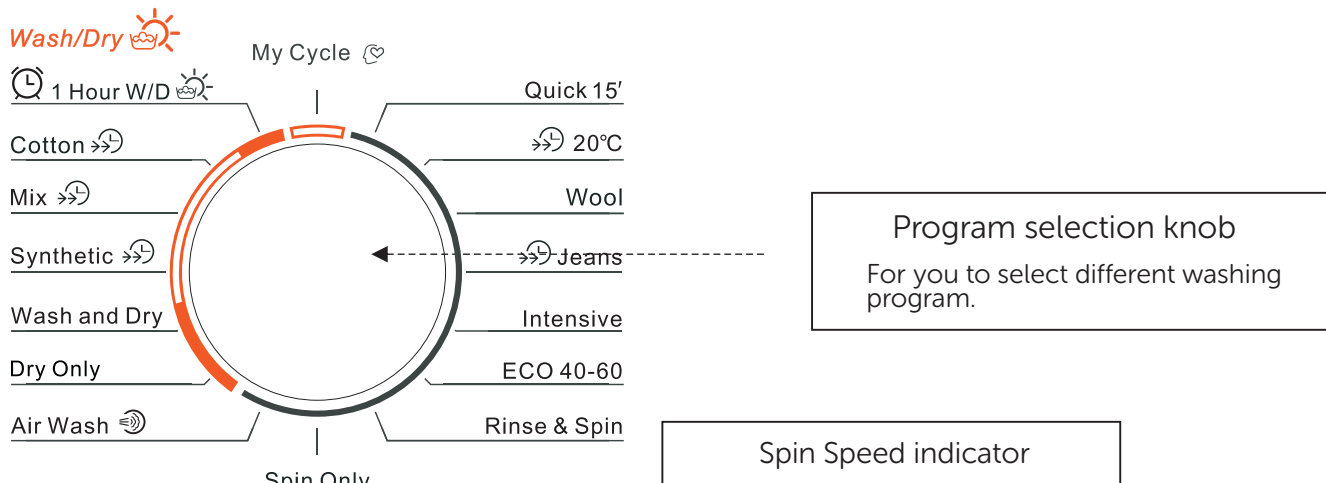

**Program selection knob**  
For you to select different washing program.

**Spin Speed indicator**  
Let you know the speed of the washing program.

WDSAE86W , WDSAE86B

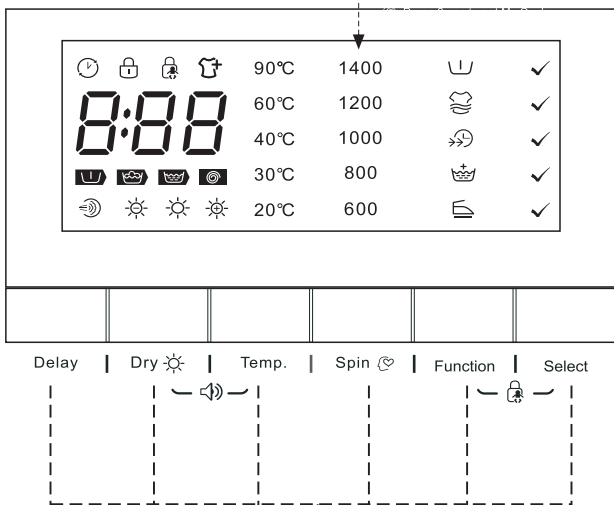

**Auxiliary functions setting**  
Press the button repeatedly to set the Delay time, Temperature, speed and so on.

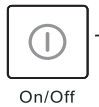

**Start/Pause**  
Press the button to start or pause the wash cycle

**On/Off**  
Press once to turn the washer-dryer on, press again to turn the washer-dryer off.

WDSAE107W , WDSAE107B

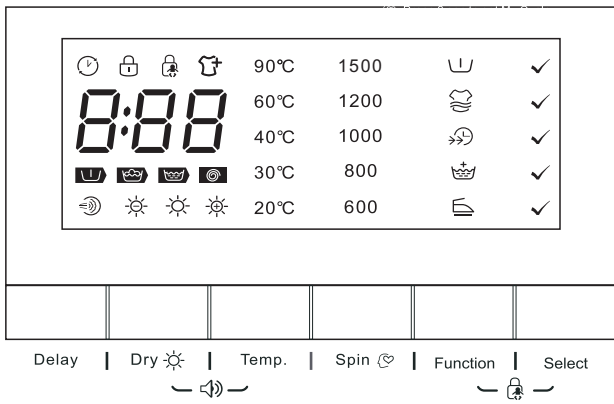

If you require any technical guidance or find that your product is not operating as intended, a simple solution can often be found in the **Troubleshooting** section of these instructions.

# Functions

## Simple everyday use

Introduction of control panel

### Turning the machine on

Plug in your machine. Place the laundry in the machine and add detergent and softener. Press the "on/off" button.

### Program selection

First, switch the program knob to select suitable program according to the types of textiles.

Second, select a proper temperature by following the care instructions on the clothes.

Last, select the proper spin speed. Generally, the higher temperature will consume more energy; the higher spin speed will cause more noise.

PLEASE NOTE: to protect the delicate clothes, the lower spin speed shall be selected.

The main washing procedures depend on the types of the clothes to be washed as follows:

### Main program

Depending on the type of textile, the following main programs are available: Each of these main programs comprise of a complete washing process, including washing, rinsing and, if required, spin cycles.

#### • 1Hour W/D

For small synthetic clothes or shirts, load limitation is 1 kg(about 4 shirts).

#### • Cotton

Hard-wearing textiles, heat-resistant textiles made of cotton or linen.

#### • Mix

Mixed load consisting of textiles made of cotton and synthetics.

#### • Synthetic

Wash synthetic articles, for example: shirts, coats, blending. While washing the knitting textiles, detergent quantity shall be reduced due to its loose string construction and easily forming bubbles.

#### • Wash and Dry

The standard energy program.

#### • Dry Only

Select it to dry clothes, the temperature is different. The drying time according to the load.

#### • Air Wash

Clothes is roasted to remove peculiar smell without water in high temperature.

#### • Spin Only

Extra spin with selectable spin speed.

#### • Rinse & Spin

Extra rinse with spin.

#### • ECO 40-60

This program is specially designed for washing duvet coats. Suitable for laundry washing at about 40°C-60°C.

#### • Intensive

To increase the washing effects, washing time is increased.

#### • Jeans

For delicate, washable textiles, e.g. made of silk, satin, synthetic fibres or blended fabrics.

#### • Wool

Hand or machine-washable wool or rich wool textiles. Especially gentle wash programme to prevent shrinkage, longer programme pauses (textiles rest in wash liquor).

#### • 20°C

20°C default, can choose cold water.

#### • Quick 15'

Extra short programme approx, suitable for lightly soiled washing as a small amounts of laundry.

# Functions

## Simple everyday use

### Introduction of control panel

#### • **Delay**

Set the Delay function:

1. Select a programme; 2. Press the Delay button to choose the time (the delaying time is 0-24 H.); 3. Press [Start/Pause] to commence the delay operation.

Choose the Programme--Setting time--Start

Cancel the Delay function:

Press the [Delay] button until the display be 0H.

It should be pressed before starting the programme. If the programme already started, should switch off programme to reset a new one.

#### • **Pre Wash**

The Prewash function can get an extra wash before main wash, it is suitable for washing the dust rises to surface of the clothes; You need to put detergent into the Case (I) when select it.

#### • **Extra Wash**

For very dirty clothes choose this feature, this will increase the washing time and intensity to improve the washing effect.

#### • **Speed Wash**

The function can decrease the washing time.

#### • **Extra Rinse**

The laundry will undergo extra rinse once after you select it.

#### • **My Cycle**

To memory the frequently used programme. After choosing the programme and setting the options, press [Spin] 3 sec. before start to wash. The default setting course is Cotton.

#### • **Anti-Crease**

Anti-Crease function can be used to reduce the wrinkles of clothes.

#### • **Reload**

This operation can be executed during the washing progress. When the drum is still rolling and there is large amount of water with high temperature in the drum. The state is unsafe and the door cannot be opened forcefully. To press [Start/Pause] for 3 sec. to reload, and start the clothes adding in the midway function. Please follow the steps as bellow:

1. Wait until the drum stops rotation.
2. The door lock is unlocked.
3. Close the door when the clothes are reloaded and press the [Start/Pause] button. Press [Start/Pause] 3 sec. --Reload the clothes-- Start

#### • **Dry**

Press the Dry button continuously to choose the dry level: Extra Dry/Normal Dry (Normal)/ Gentle Dry (Soft).

☀ Extra Dry: Need to wear clothes immediately, we can choose this function;

☀ Normal Dry (Normal): The normal dry procedure;

☀ Gentle Dry (Soft): Only to dry slightly and then is just ok;

☀ Air Dry: Clothes is roated to remove peculiar smell without water in high temperature.

If you require any technical guidance or find that your product is not operating as intended, a simple solution can often be found in the **Troubleshooting** section of these instructions.

# Functions

Simple everyday use

Program Selection Guide - 8kg washer-dryer(WDSAE86W/WDSAE86B)

Procedure Description	Max. Load(kg) WDSAE86W WDSAE86B	Detergent Box			Delay	Speed Wash ↻	Extra Rinse +	Prewash U	Extra Wash ↻	Less Iron	Max. Water Temp.(°C)	Washing Time (H) WDSAE86W WDSAE86B	Max. Speed(RPM) 1400
		Case I	Case II	Softener Case									
ECO 40-60	8.0	×	●	○	○	×	×	×	×	×	—	3:35	1400
Air Wash	1.0	×	×	×	○	×	×	×	×	×	—	0:30	—
Quick 15'	2.5	×	●	○	○	×	×	×	×	×	Cold	0:15	800
Intensive	8.0	×	●	○	○	×	×	×	×	×	40	3:48	800
Wool	2.0	×	●	○	○	×	○	×	×	○	40	1:07	600
20°C	4.0	×	●	○	○	○	○	×	×	○	20	1:01	1000
Jeans	2.0	○	●	○	○	○	○	○	○	○	30	1:35	1000
Spin Only	8.0	×	×	×	○	×	×	×	×	○	—	0:12	1000
Rinse&Spin	8.0	×	×	○	○	×	○	×	×	○	—	0:20	1000
Dry Only	6.0	×	×	×	○	×	×	×	×	×	—	4:14	1200
Mix	8.0	○	●	○	○	○	○	○	○	○	40	1:20	800
Wash and Dry	6.0	×	●	○	○	×	×	×	×	×	—	5:04	1400
Synthetic	4.0	○	●	○	○	○	○	○	○	○	40	3:17	1200
Cotton	8.0	○	●	○	○	○	○	○	○	○	40	3:39	1400
1 Hour W/D	1.0	×	●	○	○	×	×	×	×	×	Cold	0:58	1400

-Concerning to Regulation(EU) 2019/2023,  
The EU energy efficiency class is(Complete Cycle): E  
Energy test program: ECO 40-60/Wash & Dry.  
ECO 40-60: as the default  
Half load for 8.0Kg machine:4.0Kg.  
Quarter load for 8.0Kg machine:2.0Kg.  
Wash and dry : dry level: ☼ (Extra Dry), Other as the default.  
-Half load for 6.0Kg machine:3.0Kg.





● Means must      ○ Means optional      × Means not necessary

Note: Water and power consumption and programme duration may differ from the table shown, subject to changes in water pressure, water hardness and temperature, ambient temperature, type and amount of laundry, selection of auxiliary functions, and fluctuations in the supply voltage.

# Functions

Simple everyday use

Program Selection Guide - 10kg washer-drier(WDSAE107W/WDSAE107B )

Procedure Description	Max. Load(kg) WDSAE107W WDSAE107B	Detergent Box			Delay	Speed Wash 	Extra Rinse 	Prewash 	Extra Wash 	Less Iron	Max. Water Temp.(°C)	Washing Time (H) WDSAE107W WDSAE107B	Max.Speed(RPM) 1500
		Case I	Case II	Softener Case									
ECO 40-60	8.0	×	●	○	○	×	×	×	×	×	—	3:35	1500
Air Wash	1.0	×	×	×	○	×	×	×	×	×	—	0:30	—
Quick 15'	2.5	×	●	○	○	×	×	×	×	×	Cold	0:15	800
Intensive	10.0	×	●	○	○	×	×	×	×	×	40	3:48	800
Wool	2.0	×	●	○	○	×	○	×	×	○	40	1:07	600
20°C	5.0	×	●	○	○	○	○	×	×	○	20	1:01	1000
Jeans	2.0	○	●	○	○	○	○	○	○	○	30	1:35	1000
Spin Only	10.0	×	×	×	○	×	×	×	×	○	—	0:12	1000
Rinse&Spin	10.0	×	×	○	○	×	○	×	×	○	—	0:20	1000
Dry Only	7.0	×	×	×	○	×	×	×	×	×	—	4:33	1200
Mix	10.0	○	●	○	○	○	○	○	○	○	40	1:20	800
Wash and Dry	7.0	×	●	○	○	×	×	×	×	×	—	5:23	1500
Synthetic	5.0	○	●	○	○	○	○	○	○	○	40	3:17	1200
Cotton	10.0	○	●	○	○	○	○	○	○	○	40	3:39	1500
1 Hour W/D	1.0	×	●	○	○	×	×	×	×	×	Cold	0:58	1500

-Concerning to Regulation(EU) 2019/2023,  
The EU energy efficiency class is(Complete Cycle): D  
Energy test program: ECO 40-60/Wash & Dry.  
ECO 40-60: as the default  
Half load for 10.0Kg machine:5.0Kg.  
Quarter load for 10.0Kg machine:2.5Kg.  
Wash and dry : dry level: ☼(Extra Dry),Other as the default.  
-Half load for 7.0Kg machine:3.5Kg.

● Means must      ○ Means optional      × Means not necessary

Note: Water and power consumption and programme duration may differ from the table shown, subject to changes in water pressure, water hardness and temperature, ambient temperature, type and amount of laundry, selection of auxiliary functions, and fluctuations in the supply voltage.

If you require any technical guidance or find that your product is not operating as intended, a simple solution can often be found in the **Troubleshooting** section of these instructions.

# Using your washer-dryer

5



# Using your washer-dryer

## Getting the most from your appliance

### Organising Laundry

- Read the washing label on each garment to help you sort your washing into different loads.
- Sort the laundry by colour, type of fabric and by how soiled it is. This will help you choose the correct programme and temperature for each wash.

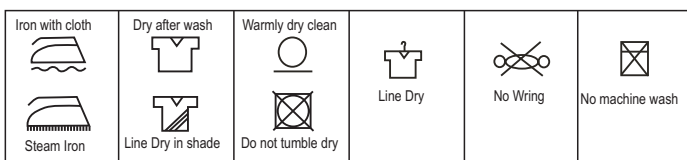
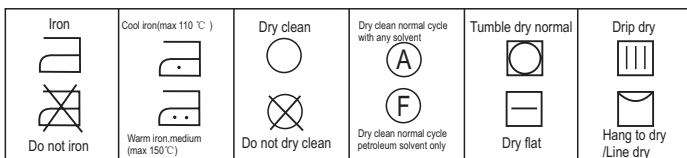
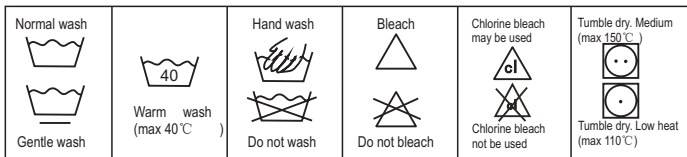

- Do not exceed the maximum load! See the programme selection table for the maximum load for the programme you require.

Articles / clothes	Approx. weight(g)
Cotton quilt covers (single/double)	900/1500
Bed sheets (single/double)	600/900
Work clothes	1120
Large tablecloths	700
Small tablecloths	350
Tea napkins	100
Bath towels	700
Hand towels	300
Blouses	150
Cotton shirts	300
shirts	180
cotton dresses	500
Jeans	800
Jacket	800
Handkerchiefs	100
T-shirts	150
Shorts	70
Socks	50

### Preparing Laundry

- Treat stains before washing.
- Some items should be put into a cleaning net before going into the washer-dryer. i.e. bras with metal wires, tights and lace clothing to prevent damage.
- Check that pockets do not contain any objects which may damage your clothes and the washer-dryer.
- Tie up any loose strings on laundry, close zippers and reverse clothing with zips inside out.
- To prevent any large, heavy objects (e.g., buckles, large buttons, etc.) from hitting the glass door, turn your clothing inside out, or remove the heavy objects. These could damage your laundry or the washer-dryer.
- Remove any surplus hair, animal fur, sand, and other materials with a brush before washing.
- If clothes have raised fabric turn them inside out.
- Clothes that are not colour fast should be washed separately.
- Insert your clothes into the washer-dryer.
- Close the washer-dryer door. Ensure that you do not trap any items of clothing between the loading door and the rubber seal.

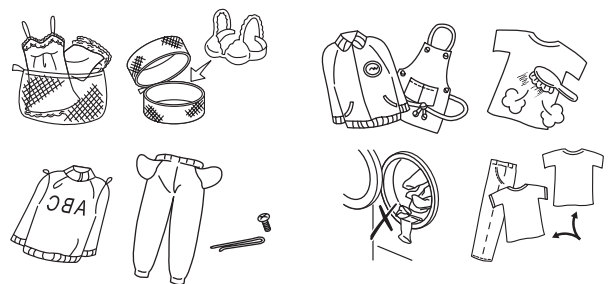

If you require any technical guidance or find that your product is not operating as intended, a simple solution can often be found in the **Troubleshooting** section of these instructions.



# Using your washer-dryer

## Getting the most from your appliance

### Adding Detergent and Softener

- Add detergent into the appropriate dispenser.
- Apply softener before you start washing.
- Apply detergent and softener according to the washing amount, the soiling level, the water hardness in your area and the manufacturer's instructions of these products.



Dilute viscous fabric softener and fabric conditioner with water. Prevent blockage of the overflow. Maximum level is 40ml.

- I Pre wash
- II Main wash
- ☼ Softener
- ☉ Release button to pull out the dispenser

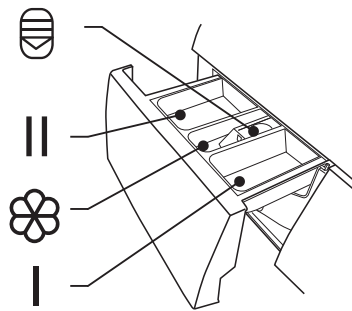

- Do not use the washer-dryer when the detergent drawer is removed. It may cause a water leak or it may not work normally.
- If you forget to add detergent, you can drain the washer-dryer by running a drain only programme. Then you can add detergent and start the programme again.
- Detergent only reaches the drum when water flushes through the detergent drawer.
- To prevent powder detergent staying in the drawer, dry the inside of the drawer with a cloth. Make sure the powder isn't lumpy when you add it into the drawer.
- If the rinse cycle isn't removing all the detergent from your wash, use less detergent.
- Softener should not exceed the MAX level in the compartment.  
Wash out unused softener with a splash of water or a damp cloth after the programme has finished.

### Before First Use

- Prior to the first use of the appliance, it is recommended to run a wash programme without clothes. A small amount of washing detergent should be used.

### Wash Setting

#### Standard Washing

1. Pull the door handle and put the laundry in the drum. (Refer to Preparation to sort your laundry before it goes into the drum.) Make sure no washing gets caught in the door.
2. Close the door and press the On/Off button.
3. Turn the Programme selection dial to select your wash programme.
4. Select the temperature if desired.
5. Add detergent into the detergent drawer. The quantity of detergent will depend on the amount of laundry, the degree of soiling and the water hardness. Use the amount of detergent suggested on the packaging.
6. Press the Start/Pause button to start the washing.
7. The washer-dryer will sound when the programme is complete.

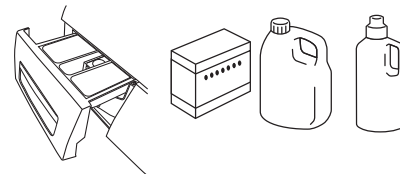

If the door is locked and you switched the washer-dryer off and then on - or if there's a power cut - it will stay locked for 1 minute.

# Using your washer-dryer

## Getting the most from your appliance

Recommended washing detergent	Wash cycles	Washing temp.	Type of laundry and textile
Heavy-duty detergent with bleaching agents and optical brighteners	Cotton, ECO 40-60, Mix, Intensive	20/30/40/60	White laundry made from boil-proof cotton or linen
Colour detergent without bleaching agent and optical brighteners	Cotton, ECO40-60, Mix, Intensive	Cold/20/30/40	Coloured laundry made from cotton or linen
Color or mild detergent without optical brighteners	Synthetic	Cold/20/30/40	Coloured laundry made from easy care fibres or synthetic materials
Mild washing detergent	Synthetic	20 /30	Delicate textiles, silk, viscose
Special wool detergent	Wool	20/30	Wool

- Agglomerating or ropy detergent or additive can be diluted in some water before pouring it into the detergent dispenser, to avoid its inlet to get blocked and thus cause a water overflow.
- Please choose the suitable type of detergent to get a maximum of washing performance and a minimum of water and energy consumption
- To achieve the best cleaning result a proper detergent dosing is important.
- Use a reduced detergent amount if the drum is not filled completely.
- Always adjust the amount of detergent to the water hardness, if your tap water is soft, use less detergent.
- Dose according to how dirty your laundry is, less dirty clothes require less detergent.
- Highly concentrated (compact detergent) requires particularly accurate dosing.

Following symptoms are a sign of detergent overdosing:

- heavy foam formation
- poor washing and rinsing result

Following symptoms are a sign of detergent underdosing:

- laundry turns grey
- built-up of limescale deposits on the drum, the heating element and/or the laundry

If you require any technical guidance or find that your product is not operating as intended, a simple solution can often be found in the **Troubleshooting** section of these instructions.

# Using your washer-dryer

## Getting the most from your appliance

Removing Washing (Once programme is finished)

 Door remains locked for 1 minute after wash stopped.

- Open the washing machine door and remove your washing.
- Remove any foreign objects to avoid risk of rusting.
- Leave the door and detergent drawer open so that residual water can evaporate.

### 1.Changing the selection after the program started?

If you need to change a setting after the wash has started, press on/off, then on/off again, Re-select the program, spin speed and optional functions, and then press the Start / Pause button. (Ensure the Child Lock is off, otherwise the original program will continue.)

### 2.Adding/removing laundry in pause mode?

To press Start/Pause button for 3 seconds, wait until the drum stops rotating. Then the door lock is unlocked, you can add/remove laundry and repress Start/Pause button after close the door.

### 3.Door lock

The icon lock will light up automatically once the program start. The door lock icon will fade out as soon as the program end and the door will be allowed to open automatically.

### 4.End of program

It will sound for 5 seconds after the end of program and the display will indicate "end" icon.

# Using your washer-dryer

Getting the most from your appliance

## Quick start

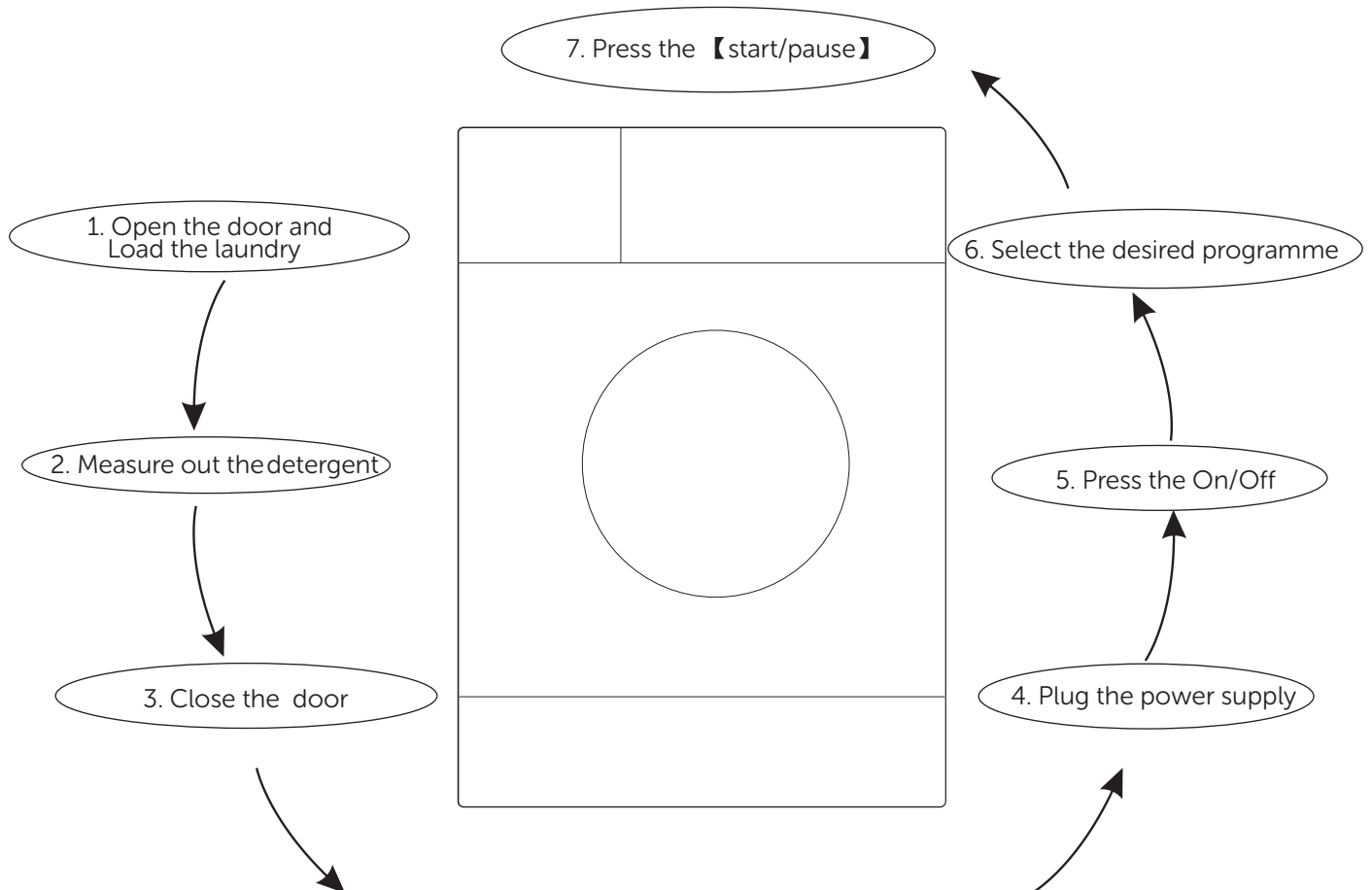

After washing :

- 1.The washer-dryer will sound several times for 5 seconds.
- 2.It is recommend to close the water tap and pull out the power plug.
- 3.The machine will empty most of the condensed water from the dryer along with the washer waste water. Only very little water will be remain inside the drum / cavity. The customer can open the door for one or two hours to dry up the remaining water. It is not necessary to remove the water manually.

If you require any technical guidance or find that your product is not operating as intended, a simple solution can often be found in the **Troubleshooting** section of these instructions.

# Care and maintenance

6



# Care and maintenance

## Looking after your appliance

Before your maintenance starts, please do pull out the power plug or disconnect power and close the tap.



- Do not use solvents clean to avoid that the washer-dryer, it will damage, and toxic gases are generated or exploded.
- Do not use the detergents containing PCMX to clean the washer-dryer.

### Cleaning and Maintenance of Washer-dryer Cabinet

- Proper maintenance on the washer-dryer can extend its working life. The surface can be cleaned with diluted nonabrasive neutral detergents when necessary. If there is any water overflow, use a wet cloth to wipe it off immediately.
- No sharp items are allowed to strike the cabinet.

Notes: Do not use formic acid and its diluted solvents or equivalent .

### Clean Internal Drum

- Rust left inside the drum by metal articles shall be removed immediately with chlorine-free detergents.
- Never use steel wool.

### Defrost a Frozen Washing Machine

When the temperature drops below zero and your washer-dryer gets frozen, you may:

- 1.Disconnect the power supply for the washer-dryer.
- 2.Wash the tap with warm water to loosen inlet pipe.
- 3.Take down inlet pipe and immerse it in warm water.
- 4.Pour warm water into washing drum and wait for 10 minutes.
- 5.Reconnect inlet pipe to the tap and check whether inlet and outlet are working normally.

Notes: when the washer-dryer is reused, make sure the ambient temperature is above 0°C

### Anti-freeze

If your washer-dryer is located in the room where it can get frozen easily, please drain the remaining water inside drain pipe and inlet pipe thoroughly.

Remove the remaining water in inlet pipe:

- 1.Close the tap.
- 2.Screw off the inlet pipe from tap and put its end into a container.
- 3.Start up any procedure except single Wash or Drain procedure. Water will be drained out of inlet pipe if any for about 40 seconds.
- 4.Reconnect the inlet pipe to tap. Remove the remaining water in drain pump (Fig11).

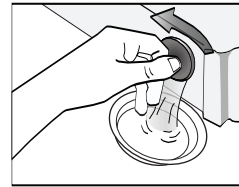

Fig 11

### Clean detergent drawer and grooves

- 1.Press down the arrow location on softener cover inside the drawer.
- 2.Lift the clip up and take out softener cover and wash all grooves with water.
- 3.Restore the softener cover and push the drawer into position.

Clean the detergent dispenser every 3 months to ensure the normal operation of the appliance

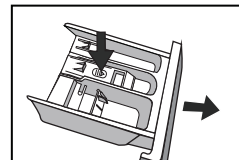

Fig 12

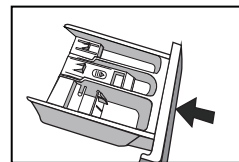

Fig 13

### Clean inlet filter

Inlet filter shall must be cleaned if there is insufficient water when the tap is opened.

Clean the tap filter:

- 1.Close the tap.
- 2.Select any procedure except "Wash" or "Drain" procedure.
- 3.Press the button "Start/Pause" and keep the procedure running for about 40 seconds.
- 4.Remove the inlet pipe from the tap.
- 5.Use water to wash the filter.
- 6.Reconnect the inlet pipe.

Washing the filter in washing machine:

- 1.Screw off the inlet pipe from the backside of the machine.
- 2.Pull out the filter with long nose pliers and reinstall it back after being washed.
- 3.Reconnect the inlet pipe.

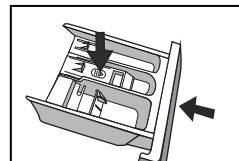

Fig 14

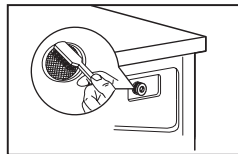
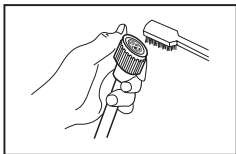

Fig 15

# Care and maintenance

## Looking after your appliance

4. Open the tap and make sure there is no water leakage.
5. Close the tap.
6. Clean the Inlet filter every 3 months to ensure the normal operation of the appliance.



**Notes: Generally, the tap filter is washed first and then the filter in washer-dryer will be washed.**

If only the filter in washer-dryer is washed, then the steps 1~3 in cleaning the tap filter shall be repeated (Fig16, 17).

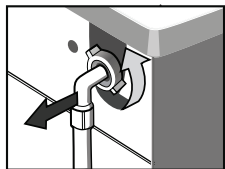

Fig 16

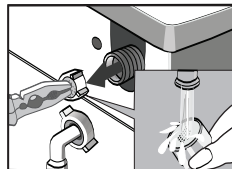

Fig 17



Pull out the power plug to avoid electrical shock before washing.  
After using the washer-dryer, remove all the clothes and close the door tightly.

### Remove foreign matters

Drain Pump Filter:

Drain pump filter can filter the yarns and small foreign matters from the washings.

Clean the filter periodically to ensure the normal operation of washer-dryer.

According to the soil level within the cycles and the frequency of the cycles, you have to inspect and clean the filter regularly.

The pump should be inspected if the machine does not empty and/or spin; The machine makes an unusual noise during draining due to objects such as safety pins, coins etc. blocking the pump.

### Clean the pump filter :

1. After the power is disconnected, use hand to open the filter cover (Fig 18).

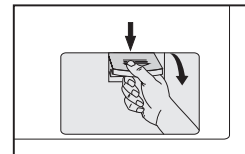

Fig 18

2. Turn the filter down as shown with the figure and take out sundries matters (Fig 19).

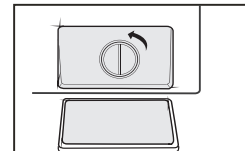

Fig 19

3. Reinstall each part after sundries matters are removed (Fig 20).

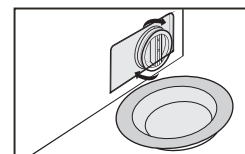

Fig 20

4. Clean the filter periodically every 3 months to ensure the normal operation of the appliance.

### Warning!

When the appliance is in use and depending on the programme selected there can be hot water in the pump. Never remove the filter during a wash cycle, always wait until the appliance has finished the cycle, and is empty. When replacing the filter, ensure it is securely retight end so.

# Care and maintenance

## Looking after your appliance

### Technical specification

Model identifier: WDSAE86W , WDSAE86B					
General product parameters:					
Parameter	Value		Parameter	Value	
Rated capacity (kg)	Rated capacity <sup>(b)</sup>	6.0	Dimensions in cm	Height	85
	Rated washing capacity <sup>(a)</sup>	8.0		Width	60
				Depth	47
Energy Efficiency Index	EEI <sub>w</sub> <sup>(a)</sup>	60.0	Energy efficiency class	EEI <sub>w</sub> <sup>(a)</sup>	B
	EEI <sub>wd</sub> <sup>(b)</sup>	82.0		EEI <sub>wd</sub> <sup>(b)</sup>	E
Washing efficiency index	I <sub>w</sub> <sup>(a)</sup>	1.04	Rinsing effectiveness (g/kg dry textile)	I <sub>R</sub> <sup>(a)</sup>	5
	J <sub>w</sub> <sup>(b)</sup>	1.04		J <sub>R</sub> <sup>(b)</sup>	5
Energy consumption in kWh per kg per cycle, for the washing cycle of the household washer-dryer, using the eco 40-60 programme at a combination of full and partial loads. Actual energy consumption will depend on how the appliance is used	0.544		Energy consumption in kWh per kg per cycle, for the wash and dry cycle of the household washer-dryer at a combination of full and half loads. Actual energy consumption will depend on how the appliance is used	3.768	
Water consumption in litre per cycle, for the eco 40-60 programme at a combination of full and partial loads. Actual water consumption will depend on how the appliance is used and on the hardness of the water	48		Water consumption in litre per cycle, for the wash and dry cycle of the household washer-dryer at a combination of full and half loads. Actual water consumption will depend on how the appliance is used and on the hardness of the water	90	
Maximum temperature inside the treated textile (°C) <sup>(a)</sup>	Rated washing capacity	38	Remaining moisture content <sup>(a)</sup> (%)	Rated capacity	53
	Half	38		Half	53
	Quarter	21		Quarter	53
Spin speed (rpm) <sup>(a)</sup>	Rated washing capacity	1400	Spin-drying efficiency class <sup>(a)</sup>	B	
	Half	1400			
	Quarter	1400			
Eco 40-60 programme duration (h:min)	Rated washing capacity	3:38	wash and dry cycle duration (h:min)	Rated capacity	9:30
	Half	2:48		Half	6:40
	Quarter	2:48			
Airborne acoustical noise emissions during the spinning phase for the eco 40-60 washing cycle at rated washing capacity	76		Airborne acoustical noise emission class for the spinning phase for the eco 40-60 programme at rated washing	B	
Type	[built-in/free-standing]		free-standing		
Off-mode (W)	0.50		Standby mode (W)	N/A	
Delay start (W) (if applicable)	4.00		Networked standby (W) (if applicable)	N/A	
<b>Minimum duration of guarantee offered by the supplier <sup>(c)</sup>: 12</b>					
This product has been designed to release silver ions during the washing cycle			NO		

If you require any technical guidance or find that your product is not operating as intended, a simple solution can often be found in the **Troubleshooting** section of these instructions.



# Care and maintenance

Looking after your appliance

WDSAE86W/WDSAE86B

Cycle	Nominal capacity in kg	Cycle duration in hours and minutes	Energy consumption in kWh/operating cycle	Water consumption in mliter/operating cycle	Highest temperature °C	residual moisture in % /spin speed
20°C	4.0	1:01	0.15	50	20	65% / 1000
Cotton(60°C)	8.0	3:44	1.498	70	60	53% / 1400
Intensive	8.0	3:48	1.100	70	40	70% / 800
Mix	8.0	1:20	0.75	65	40	70% / 800
Quick 15'	2.0	0:15	0.030	40	Cold	75% / 800
ECO40-60	8.0	3:38	0.871	64	40	53%/1400
	4.0	2:48	0.530	46.3	33	53%/1400
	2.0	2:48	0.205	33.4	23	53%/1400
Wash and Dry	6.0	9:30	4.680	108.4	39	0%/1400
	3.0	6:40	2.400	63.5	27	0%/1400

- The above data is for reference only, and the data may change due to different actual use conditions.
- The values given for programmes other than the ECO 40-60 programme and the Wash and Dry cycle are indicative only.
- Concerning to Regulation(EU) No 1061/2010,  
The EU energy efficiency class is: A  
Energy test program: Intensive;Speed:The highest speed; Temp.: 60°C;  
Other as the default.  
Load for 8.0Kg machine:6.0Kg.
- Concerning to Regulation(EU) 2019/2023,  
The EU energy efficiency class is: E  
Energy test program: ECO 40-60/Wash & Dry.  
ECO 40-60: as the default  
Half load for 8.0Kg machine:4.0Kg.  
Quarter load for 8.0Kg machine:2.0Kg.  
Wash and dry : dry level: ☼ (Extra Dry),Other as the default.  
Load for 8.0Kg machine:6.0Kg.  
Half load for 6.0Kg machine:3.0Kg.

# Care and maintenance

Looking after your appliance

## Technical specification

Model identifier: WDSAE107W , WDSAE107B					
General product parameters:					
Parameter	Value		Parameter	Value	
Rated capacity (kg)	Rated capacity <sup>(b)</sup>	7.0	Dimensions in cm	Height	85
	Rated washing capacity <sup>(a)</sup>	10.0		Width	60
				Depth	57
Energy Efficiency Index	EEI <sub>w</sub> <sup>(a)</sup>	60.0	Energy efficiency class	EEI <sub>w</sub> <sup>(a)</sup>	B
	EEI <sub>WD</sub> <sup>(b)</sup>	67.0		EEI <sub>WD</sub> <sup>(b)</sup>	D
Washing efficiency index	I <sub>w</sub> <sup>(a)</sup>	1.04	Rinsing effectiveness (g/kg dry textile)	I <sub>R</sub> <sup>(a)</sup>	5
	J <sub>w</sub> <sup>(b)</sup>	1.04		J <sub>R</sub> <sup>(b)</sup>	5
Energy consumption in kWh per kg per cycle, for the washing cycle of the household washer-dryer, using the eco 40-60 programme at a combination of full and partial loads. Actual energy consumption will depend on how the appliance is used	0.593		Energy consumption in kWh per kg per cycle, for the wash and dry cycle of the household washer-dryer at a combination of full and half loads. Actual energy consumption will depend on how the appliance is used	3.430	
Water consumption in litre per cycle, for the eco 40-60 programme at a combination of full and partial loads. Actual water consumption will depend on how the appliance is used and on the hardness of the water	52		Water consumption in litre per cycle, for the wash and dry cycle of the household washer-dryer at a combination of full and half loads. Actual water consumption will depend on how the appliance is used and on the hardness of the water	100	
Maximum temperature inside the treated textile (°C) <sup>(a)</sup>	Rated washing capacity	38	Remaining moisture content <sup>(a)</sup> (%)	Rated capacity	53
	Half	36		Half	53
	Quarter	23		Quarter	53
Spin speed (rpm) <sup>(a)</sup>	Rated washing capacity	1500	Spin-drying efficiency class <sup>(a)</sup>	B	
	Half	1500			
	Quarter	1500			
Eco 40-60 programme duration (h:min)	Rated washing capacity	3:59	wash and dry cycle duration (h:min)	Rated capacity	9:40
	Half	3:00		Half	7:00
	Quarter	3:00			
Airborne acoustical noise emissions during the spinning phase for the eco 40-60 washing cycle at rated washing capacity	80		Airborne acoustical noise emission class for the spinning phase for the eco 40-60 programme at rated washing	C	
Type	[built-in/free-standing]		free-standing		
Off-mode (W)	0.50		Standby mode (W)	NA	
Delay start (W) (if applicable)	4.00		Networked standby (W) (if applicable)	NA	
<b>Minimum duration of guarantee offered by the supplier <sup>(c)</sup>: 12</b>					
This product has been designed to release silver ions during the washing cycle			NO		

If you require any technical guidance or find that your product is not operating as intended, a simple solution can often be found in the **Troubleshooting** section of these instructions.

# Care and maintenance

Looking after your appliance

WDSAE107W/WDSAE107B

Cycle	Nominal capacity in kg	Cycle duration in hours and minutes	Energy consumption in kWh/operating cycle	Water consumption in mliter//operating cycle	Highest temperature °C	residual moisture in % /spin speed
20°C	5.0	1:01	0.25	60	20	65% / 1000
Cotton(60°C)	10.0	3:44	1.708	80	60	53% / 1500
Intensive	10.0	3:48	1.305	80	40	70% / 800
Mix	10.0	1:20	0.85	80	40	70% / 800
Quick 15'	2.0	0:15	0.030	40	Cold	75% / 800
ECO 40-60	10.0	3:59	1.058	73	38	53%/1500
	5.0	3:00	0.668	53	36	53%/1500
	2.5	3:00	0.240	38	23	53%/1500
Wash and dry	7.0	9:40	4.190	115.0	27	0/1500
	3.5	7:00	2.291	77.0	21	0/1500

- The above data is for reference only, and the data may change due to different actual use conditions.
- The values given for programmes other than the ECO 40-60 programme and the Wash and Dry cycle are indicative only.
- Concerning to Regulation(EU) No 1061/2010,  
The EU energy efficiency class is: A  
Energy test program: Intensive;Speed:The highest speed; Temp.: 60°C;  
Other as the default.  
Load for 10.0Kg machine:7.0Kg.
- Concerning to Regulation(EU) 2019/2023,  
The EU energy efficiency class is: D  
Energy test program: ECO 40-60/Wash & Dry.  
ECO 40-60: as the default  
Half load for 10.0Kg machine:5.0Kg.  
Quarter load for 10.0Kg machine:2.5Kg.  
Wash and dry : dry level: ☼ (Extra Dry), Other as the default.  
Load for 10.0Kg machine:7.0Kg.  
Half load for 7.0Kg machine:3.5Kg.

# Care and maintenance

## Special note for Eco design

- 1) Maximum amount of dry textiles that can be treated in the respective cycle
- 2) The highest temperature reached by the laundry in the wash cycle for at least 5 minutes.
- 3) Residual moisture after the wash cycle in water content percent and the spin speed at which this was achieved.
- 4) The ECO 40-60 programme is able to clean normally soiled cotton laundry declared to be washable at 40°C or 60°C, together in the same cycle. This programme is used to assess the compliance with the regulation (EU) 2019/2023.
- 5) The Wash and Dry programme, dry level setting "☼" Extra Dry is able to clean normally soiled cotton laundry declared to be washable at 40°C or 60°C, together in the same cycle, and to dry it in such a way that it can be immediately stored in a cupboard. This programme is used to assess the compliance with the regulation (EU) 2019/2023.

The most efficient programmes in terms of energy consumption are generally those that perform at lower temperatures and longer duration.

Loading the household washer-dryer up to the capacity indicated for the respective programmes will contribute to energy and water savings.

Noise and remaining moisture content are influenced by the spinning speed: the higher the spinning speed in the spinning phase, the higher the noise and the lower the remaining moisture content.

Caution! If there is any break in the power supply while the machine is operating, a special memory stores the selected programme. The machine will continue the programme when the power supply is re-established.

The model information can be retrieved using the QR-Code reported in the energy label. The label also includes the model identifier that can be used to consult the portal of the registry at <https://eprel.ec.europa.eu>.

1. The higher the spinning speed in the spinning phase, the higher the noise and the lower the remaining moisture content.
2. The guarantee will be rendered invalid if the product has been damaged by inexpert repair.

Product support

7



# Product support

Help is always at hand

## Troubleshooting

### 1. Washer-dryer does not operate?

Check if the door is closed tightly, power plug is inserted well and then press start/pause button.

### 2. Washer-dryer does not receive water?

Check if the water tap is opened and clean the filters of water inlet hose.

### 3. Washer-dryer is not draining water?

Check the drain hose and clean pump filter.

### 4. Washer-dryer is vibrating?

Check if the feet are adjusted well and make sure transportation screws are removed.

### 5. The washing result is poor?

Select suitable program and use more detergent.

### 6. No water is seen in the drum during washing?

No failure. The water is in the lower part of the drum.

### 7. There are residues of detergent on the clothes?

Some detergents contain ingredients which are not soluble in water and which may form white stains on your clothes. Please adjust your machine, carry out an additional rinse, or eliminate the stains after drying, with a brush.

### 8. There are grey stains on the clothes?

These stains may be caused by oil, cream or ointment. In the next washing operation, use the maximum detergent amount declared by the detergent producer.

## Error Codes

Description	Possible cause	Solution
<b>E30</b>	Door is not closed properly	Close the door properly and restart.
<b>E10</b>	Water injecting problem during wash cycle.	Check if the water pressure is high enough. Straighten the water pipe. Clean the inlet valve filter.
<b>E21</b>	Overtime water draining	Check the drain hose for blockage.
<b>E12</b>	Water overflow	Restart the appliance.
<b>EXX</b>	Others	Restart the appliance. If problem persists, please contact the customer service.

If you require any technical guidance or find that your product is not operating as intended, a simple solution can often be found in the **Troubleshooting** section of these instructions.

# Product support

Help is always at hand

## Help and assistance

If you require any technical guidance or find that your washer-dryer is not operating as intended, a simple solution can often be found in the **Troubleshooting** section of these instructions or online at

[www.bush-support.com](http://www.bush-support.com)

If you still require further assistance, call one of our experts on **0345 257 7271\*** To help give us give you a fast and efficient service please have the following information ready:

Model Ref.	<input type="text"/>	You can find these on the rating plate - a small information panel (usually a sticker or metal plate) on the rear of your appliance
Serial number	<input type="text"/>	
Date of purchase	<input type="text"/>	This will be shown on your receipt

Local call rates applies\*

Lines open 8am-7pm Monday to Saturday and 10am-4pm Sunday.

\*Calls to Argos enquiry lines may attract a charge and set up fee from residential lines depending on your call plan/tarif. Mobile and other providers costs may vary, see [www.bt.com/pricing](http://www.bt.com/pricing) for details.

For Security and training purposes, telephone calls to and from customer service centres maybe recorded and monitored. Calls from Republic of Ireland will attract international call charges.

or online at [www.bush-support.com](http://www.bush-support.com) If you still require further assistance, call one of our experts on **0345 257 7271**.

# Product support

Help is always at hand

## Spare Parts Supply

To order spare parts, please contact our customer helpline: 0345 257 7271.

The original spare parts for some specific components are available for a period of 10 years, based on the type of component, from the placing on the market of the last unit of the model.



This appliance complies with the following EEC directives:  
2014/35/EU Low Voltage Directive  
2014/30/EU EMC Directive

## Notes on disposal:



This marking indicates that this product should not be disposed with other household wastes throughout the UK. To prevent possible harm to the environment or human health from uncontrolled waste

disposal, recycle it responsibly to promote the sustainable reuse of material resources. To return your used device, please use the collection systems or contact the retailer where the product was purchased. They may return and may take this product for environmental safe recycling.

If you require any technical guidance or find that your product is not operating as intended, a simple solution can often be found in the **Troubleshooting** section of these instructions.



# Product support

Help is always at hand



Call us now and activate your 12 month guarantee

Thank you for choosing Bush. Your new product is guaranteed against faults and breakdowns for 12 months. Don't forget to register it with us today so we can provide you with our best possible after-sales service and useful updates.

[www.bushregistration.co.uk](http://www.bushregistration.co.uk)

FREEPHONE\*

0800 597 8548

Lines are open 8am - 8pm, 365 days a year. \*Calls may be recorded and monitored.

## Your Bush Guarantee

This product is guaranteed for twelve months from the date of original purchase. Any defect that arises due to faulty materials or workmanship will be repaired free of charge (or if applicable the product will be replaced or the purchase price refunded) where possible during this period by the dealer from who your purchased the unit.

The guarantee is subject to the following provisions:

- The guarantee does not cover accidental damage, misuse, cabinet parts, knobs or consumable items.
- The product must be correctly installed and operated in accordance with the instructions contained in the manual.
- It must be used solely for domestic purposes. The guarantee will be rendered invalid if the product is re-sold or has been damaged by inexpert repair.
- Specifications are subject to change without notice.
- Bush disclaim any liability for loss or damage arising from the breakdown of the product.
- This guarantee is in addition to and does not diminish your statutory or legal rights.

## Important Data Protection Information

To find out how we and Domestic & General Insurance Plc use your data please refer to the guarantee registration material or visit [www.bushregistrations.co.uk](http://www.bushregistrations.co.uk).

Guarantor: Argos Limited - 489 - 499 Avebury Blvd. - Milton Keynes - MK9 2NW

or online at [www.bush-support.com](http://www.bush-support.com) If you still require further assistance, call one of our experts on 0345 257 7271.

# BUSH

Contact:

[www.bush-support.com](http://www.bush-support.com)

Helpline: 0345 257 7271