

Ⓐ 1 x Seat Cushion

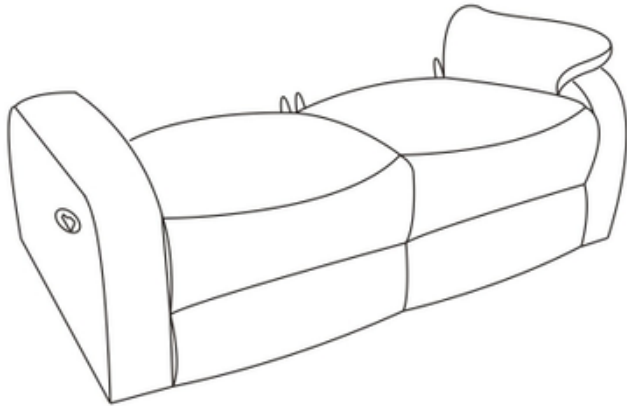

Ⓑ 1 x Left Back Rest

Ⓒ 1 x Right Back Rest

Ⓓ 1 x Left Arm Cushion

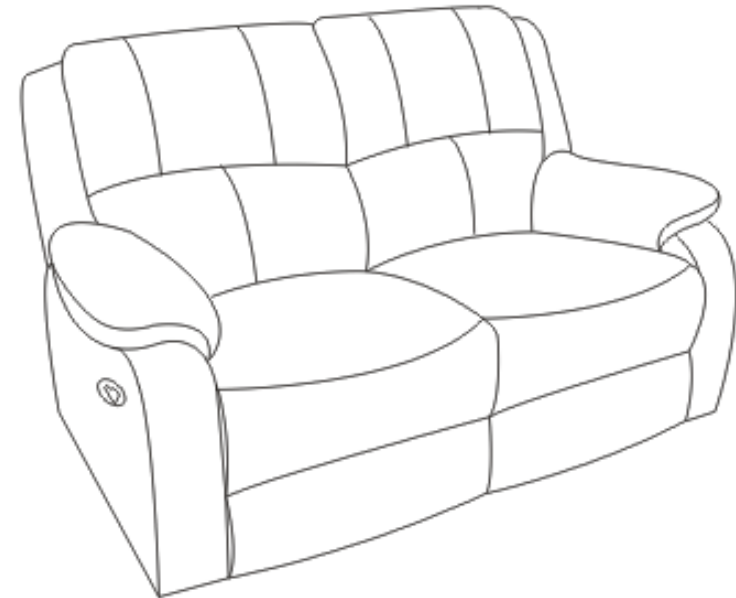
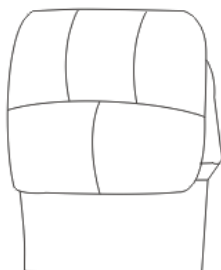
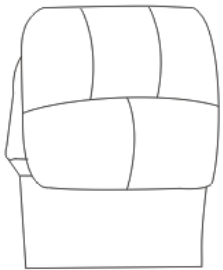

Ⓔ 1 x Right Arm Cushion



**Important-please read these instructions fully before starting assembly**

**if you need help or have damaged or missing parts, call the customer helpline:** 0345 640 0800  
0345 601 2895

- 1. Read these instructions carefully and familiarise yourself with the procedure before assembling the unit.*
- 2. Check that you have all the component parts following the list on the back cover and familiarise yourself with each part before proceeding.*
- 3. Take all the fittings out of the plastic bag and separate them into their groups.*
- 4. Ensure you have enough space to lay out all the parts before assembly.*
- 5. To avoid scratching it is recommended that you assemble the unit on a soft level surface.*

# Assembly Instructions

## Stage 1 – Fitting the Unit

**NOTE:** It would be useful to ask someone to help you at this stage.

1. Attach the Left Back Rest (B) and Right Back Rest (C) to the Seat Cushion (A). Engage the metal locks and push fit. You should hear them lock into position.

See fig.1.

2. Fit the velcro cover on the back rests onto the velcro on the seat cushion.

3. Attach the Left Arm Cushion (D) and Right Arm Cushion (E) on the Arm.

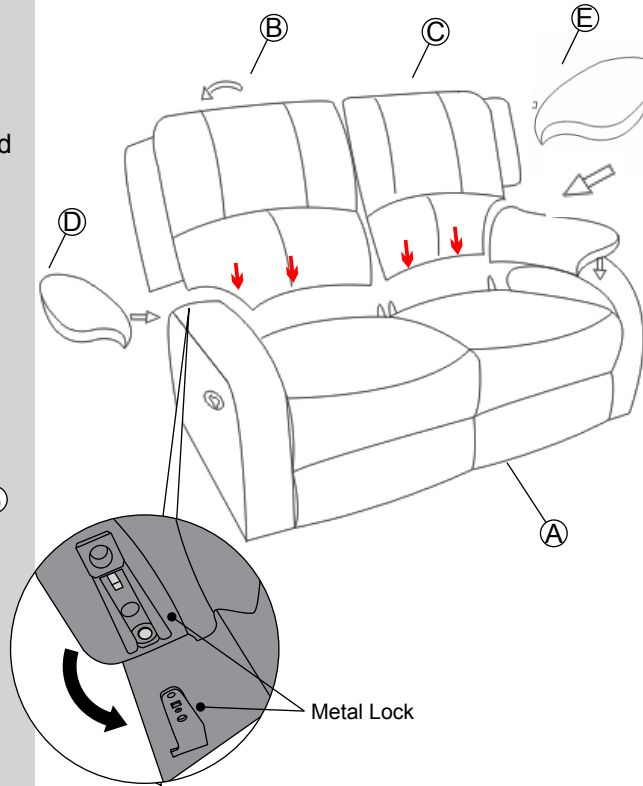

fig. 1

**NOTE:** Carefully line up the two side metal locks. Ensure they align correctly.



### CAUTION:

- Beware of entrapment. Keep hands and fingers clear of the tilt mechanism when operating the controls.
- Ensure that children or pets are not playing or lying in the way when the tilt mechanism is operated.
- Prevent children from playing on the furniture or with the controls.

# Assembly Instructions

## Stage 2 – Finishing the Unit

### Back and Foot Rest Adjustment

This Chair features a reclining back rest and raised foot rest. You need to be sitting in the chair to activate the features.

1. Pull the "Adjustment Lever" then gently lean back, the chair will recline and the foot rest will automatically lift up.

**See fig. 2.**

2. Sit up and lock the foot rest. The sofa return to the normal position.

**See fig. 2.**

3. Adjust the recliner to your own requirements.

4. Finally carefully place the unit in the desired location.

**See fig. 3.**

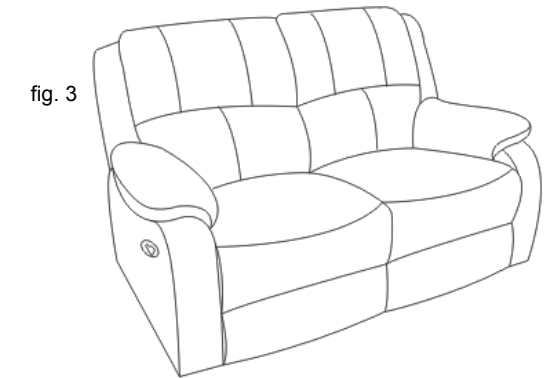
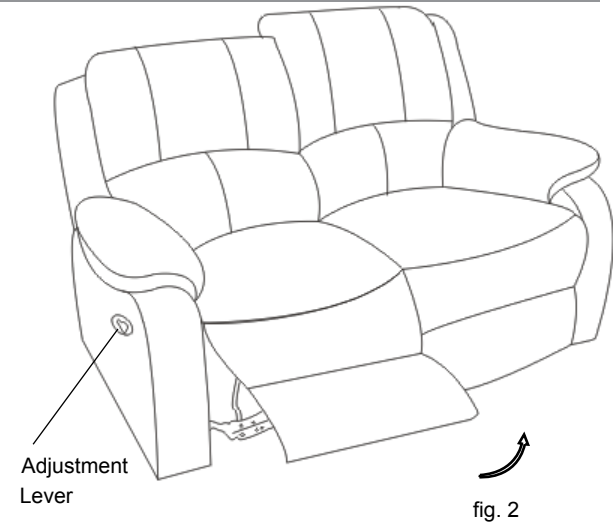

## Care and Maintenance

### Safety

To avoid any risk of suffocation to animals or children dispose of the plastic bags immediately.

### Cleaning

As with all surfaces clean with a damp cloth and mild detergent, do not use bleach or abrasive products.

### Fitting

From time to time please ensure there are no loose screws on the product.

# Assembly Instructions

## Arm cushion assembly steps

1. Please fix the arm cushion by zipping it on to the outside of the armrest

See fig.4



see fit 4

2. Adjust the cushion with the right position onto the armrest see fig.5



see fit 5

# Assembly Instructions

3. press the seat cushion next to the inside of armrest the stick the Velcro into the inside of armrest see fit 6



see fit 6