

# MICROWAVE OVEN

**cookworks**

Installation & User Instructions – Please keep for future reference

835/3481

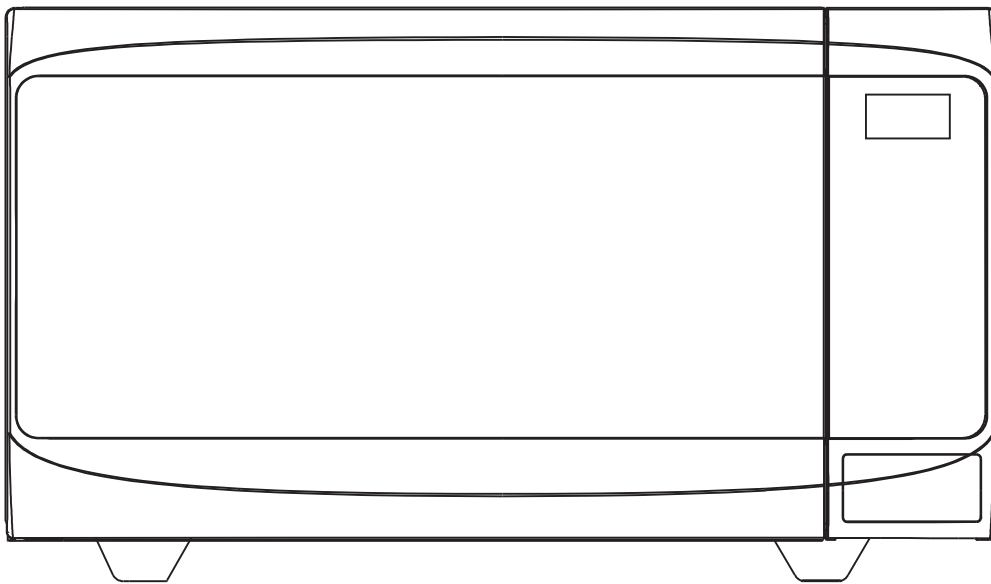

## Important

- **WARNING** : if the door or door seals are damaged, the oven must not be operated until it has been repaired by a competent person;
- **WARNING** : it is hazardous for anyone other than a competent person to carry out any service or repair operation that involves the removal of a cover which gives protection against exposure to microwave energy;
- **WARNING** : liquids and other food must not be heated in a sealed container since they are liable to explode;
- **WARNING** : accessible parts may become hot during. Young children should be kept away.
- **WARNING** : metallic containers for food and beverages are not allowed during microwave cooking.

# Contents

<b>Safety Information</b>	<b>2</b>
<b>Material you can use in microwave oven</b>	<b>7</b>
Material to avoid using in the microwave oven	7
Utensils	8
<b>Setting up your oven</b>	<b>8</b>
Oven components and accessories	8
Turntable installation	8
Microwave cooking principles	9
Microwave food packaging symbols	9
Accessories included	9
<b>Installation</b>	<b>10</b>
Please note electrical connection	10
Earthing Installation	11
<b>Operating your microwave oven</b>	<b>12</b>
Control Panel	12
Setting the Clock	13
Microwave Cooking	13
Express	14
Weight Defrost	14
Multi-stage Cooking	15
Defrost / Time	15
Child lock	15
Preset function	16
Warming Up and Heating	17
<b>Cleaning your microwave oven</b>	<b>19</b>
<b>Troubleshooting and maintenance</b>	<b>19</b>
<b>Troubleshooting</b>	<b>20</b>
<b>Questions and Answers</b>	<b>21</b>
<b>Technical Specifications</b>	<b>22</b>
Disposal information	
<b>Guarantee</b>	

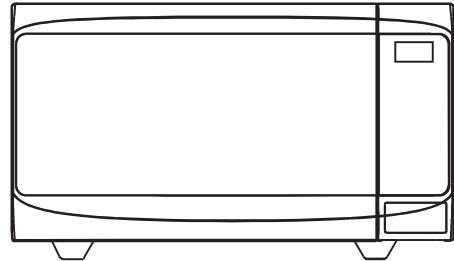

## Product Codes

P70B17AP-S1



# Safety Information

**Important – Please read these instructions fully before installation**

## **IMPORTANT SAFETY INSTRUCTIONS**

### **READ CAREFULLY AND KEEP FOR FUTURE REFERENCE**

1. The temperature of accessible surfaces may get hot when the appliance is operating especially the metal top area and the warming rack if any.
2. This appliance can be used by children aged from 8 years and above and persons with reduced physical, sensory or mental capabilities or lack of experience and knowledge if they have been given supervision or instruction concerning use of the appliance in a safe way and understand the hazards involved. Children shall not play with the appliance. Cleaning and user maintenance shall not be made by children unless they are older than 8 and supervised\*
3. The appliance is not intended to be operated by means of an external timer or separate remote-control system.
4. The appliance is intended to be used in household not for commercial use and similar applications such as :
  - staff kitchen areas in shops, offices and other working environment;
  - by clients in hotels, motels and other residential type environments;
  - farm houses;
  - bed and breakfast type environments.
5. **WARNING:** If the door or door seals are damaged, the oven must not be operated until it has been repaired by a competent person.
6. **WARNING:** It is hazardous for anyone other than a competent person to carry out any service or repair operation that involves the removal of a cover which gives protection against exposure to microwave energy.
7. **WARNING:** Liquids and other foods must not be heated in sealed containers since they are liable to explode.
8. A minimum clearance of 12 inches (30cm) must be left above the top of the oven.
9. Only use utensils that are suitable for use in microwave ovens.
10. When heating food in plastic or paper containers, keep an eye on the oven due to the possibility of ignition.
11. The microwave oven is intended for heating food and beverages. Drying of food or clothing and heating of warming pads, slippers, sponges, damp cloth and similar may lead to risk of injury, ignition or fire.



## Safety Information

**Important – Please read these instructions fully before installation**

12. If smoke is observed, press the “Stop” button and leave the door closed in order to stifle any flames. Disconnect the power cord, and / or shut off power at the fuse or circuit breaker panel.”
13. Microwave heating of beverages can result in delayed eruptive boiling, therefore care must be taken when handling the container.
14. The contents of feeding bottles and baby food jars shall be stirred or shaken and the temperature checked before consumption, in order to avoid burns.
15. Eggs in their shell and whole hard-boiled eggs should not be heated in microwave ovens since they may explode, even after microwave heating has ended. Pierce foods with heavy skins such as potatoes, squashes, apples and chestnuts before cooking.
16. The oven should be cleaned regularly and any food deposits removed.
17. When cleaning door and oven surfaces use only mild, non-abrasive soaps or detergents applied with a sponge or soft cloth.
18. Failure to maintain the oven in a clean condition could lead to deterioration of the surface which could adversely affect the life of the appliance and possibly result in a hazardous situation.
19. The microwave oven shall not be placed in a cabinet.
20. The rear surface of appliances shall be placed against the wall. This appliance incorporates an earth connection for functional purposes only.
21. **WARNING** : The appliance and its accessible parts become hot during use. Care must be taken to avoid touching heating elements. Children less than 8 years of age shall be kept away unless continuously supervised. Warning: When the appliance is operated in the combination mode, children should only use the oven under adult supervision due to the temperatures generated.
22. Do not use harsh abrasive cleaners or sharp metal scrapers to clean the oven doorglass since they can scratch the surface, which may result in shattering of the glass.
23. The appliance shall not be cleaned with a steam cleaner. Caution! Steam will escape, when opening lids or wrapping foil.
24. The Oven must be placed on a level surface.
25. The turntable and turntable ring assembly must always be used in the oven during cooking Place the cookware gently on the turntable and handle it carefully to avoid possible breakage.



## Safety Information

**Important – Please read these instructions fully before installation**

26. Incorrect use of dish for browning food may cause turntable to break.
27. Use only the specified bag size when using pre-prepared popcorn.
28. The Oven has several built-in safety switches to ensure that the power remain off when the door is open. Do not tamper with these switches.
29. Do not operate the microwave oven when empty. Operating the oven with no food or food that is extremely low in moisture can cause fire, charring or sparking.
30. Do not cook bacon directly on the turntable. Excessive local heating of the turntable may cause the turntable to break.
31. Do not heat narrow-necked containers, such as syrup or sauce bottles.
32. Do not attempt to deep-fry in your microwave oven. Hot oil can damage oven parts and utensils and even result in skin burns.
33. Do not attempt home canning in this microwave oven as it is impossible to be sure all contents of the jar have reached boiling temperature.
34. Caution: Stir the liquid prior to and during heating/reheating, let liquid stand for a least 10 seconds after cooking and always take care when add in ingredients to hot liquids. Microwave heating of beverages can result in delayed eruptive boiling, therefore care must be taken when handling the container.
35. Check the food in the microwave oven frequently to avoid burning due to overheating.
36. Stand at arm's length when opening the door to avoid scalding when steam or hot air is released. The oven has switched off according to the food being cooked to allow heat to distribute evenly throughout the food.
37. Always allow an appropriate standing time after the oven has switched off according to the food being cooked to allow heat to distribute evenly throughout the food.
38. Use oven gloves when removing any cookware from oven to reduce chance of being burned or scalded. Cooking utensils may become hot because of heat transferred from the heated food. Pot holders may be needed to handle the utensil.
39. Read and follow the specific: "Precaution for avoiding possible exposure to excessive microwave energy".



## Safety Information

**Important – Please read these instructions fully before installation**

40. As with most cooking appliances, close supervision is necessary to reduce the risk of a fire in the oven cavity. This microwave oven is intended for heating food and beverages. Drying of food or clothing and heating of warming pads, slippers, sponges, damp cloths and similar may lead to risk of injury, ignition or fire.
41. Do not overcook food. Regularly observe the oven if paper, plastic, or other combustible materials are used in the oven. The microwave oven is intended for defrosting, cooking and steaming of food only.
42. Do not use the oven cavity for storage purposes. Do not leave paper product, cooking utensils or food in the cavity when not in use.
43. Remove wire twist-ties and metal handles from paper or plastic containers/bags before placing them in the oven.
44. This oven must be earthed. Connect only to properly earthed outlet. See "earthing installation".
45. Install or locate this oven in accordance with the installation instructions provided.  
Warning: Do not install oven over a range cooktop or other heat-producing appliance. If installed could be damaged and the warranty would be void.
46. Use this appliance only for its intended uses as described in the manual. Do not use corrosive chemicals or vapours in the appliance. This Oven is specifically designed to heat or cook food. It is not designed for industrial or laboratory use.
47. If the supply cord or plug is damaged, or if the oven is not working properly or has been dropped it must be replaced or repaired by the manufacturer or its service agent or a similarly qualified person in order to avoid hazard.
48. This appliance should be serviced only by qualified service technicians. Contact the nearest authorised service facility for examination, repair or adjustment.
49. Do not cover or block any vents on the oven.
50. Do not store or use this appliance outdoors.
51. Do not use this oven near water, near a kitchen sink, in a wet basement or near a swimming pool.
52. Do not immerse cord or plug in water.
53. Keep cord away from heated surfaces.



## Safety Information

**Important – Please read these instructions fully before installation**

54. Do not let cord hang over edge of table or counter.
55. Do not attempt to repair the oven yourself, please consult an authorised service agent
56. Do not attempt to operate this oven with the door open since open-door operation can result in harmful exposure to microwave energy. It is important not to try and override or tamper with the safety interlocks.
57. Do not operate the oven if it is damaged. It is particularly important that the oven door closes properly and that there is no damage to the, (1) door (i.e. door is not bent or dented), (2) hinges and latches (broken or loosened), (3) door seals and sealing surfaces.
58. Utensils should be checked to ensure that they are suitable for use in microwave ovens.
59. The  symbol on the product or on its packaging indicates that this product may not be treated as household waste. Instead it shall be handed over to the applicable collection point for the recycling of electrical and electronic equipment. By ensuring this product is disposed of correctly, you will help prevent potential negative consequences for the environment and human health, which could otherwise be caused by inappropriate waste handling of this product. For more detailed information about recycling of this product please contact your local city office, your household waste disposal service or the shop where you purchased the product.
60. The lamp holder must be serviced by an authorized service agent. Never remove the distance holder in the back or on the sides, it ensures a minimum distance from the wall for air circulation.
61. During use the appliance becomes hot. Care should be taken to avoid touching heating elements inside the oven.
62. The product is classified as a Group 2, Class B, ISM appliance. Group 2 includes all ISM (Industrial, Scientific or Medical) appliances in which radio frequencies are generated intentionally and/or used in the form of electromagnetic radiation to treat materials, together with electroerosion equipment. Class B includes equipment for domestic use or on premises directly connected to low voltage electricity supply for supplying buildings for residential use.
63. This appliance complies with EC directive 2014/30/EU on electromagnetic compatibility and European regulation no. 1935/2004 of 27/10/2004 on food contact materials.

# Materials you can use in microwave oven

Utensils	Remarks
Aluminum foil	Shielding only. Small smooth pieces can be used to cover thin parts of meat or poultry to prevent overcooking
Arcing can occur if foil is too close to oven walls.	The foil should be a least 1 inch (2.5cm) away from oven walls.
Browning dish	Follow manufacturer's instructions. The bottom of browning dish must be at least 3/16 inch (5mm) above the turntable. Incorrect usage cause the turntable to break
Dinnerware	Microwave-safe only. Follow manufacturer's instructions. Do not use cracked or chipped dishes.
Glass jars	Always remove lid. Use only to heat food until just warm. Most glass jars are not heat resistant and may break
Glassware	Heat-resistant oven glassware only. Make sure there is no metallic trim. Do not use cracked or chipped dishes.
Oven cooking bags	Follow manufacturer's instructions. Do not close with metal tie. Make slits to allow steam to escape.
Paper plates and cups	Use for short-term cooking/warming only. Do not leave oven unattended while cooking.
Paper towels	Use to cover food for reheating and absorbing fat. Use with supervision for short-term cooking only.
Parchment paper	Use as a cover to prevent splattering and retain moisture
Plastic	Microwave-safe only. Follow the manufacturer's instructions. Should be labelled "Microwave Safe". Some plastic containers soften as the food inside gets hot. "Boiling bags" and tightly closed plastic bags should be slit, pierced or vented as directed by package.
Plastic wrap	Microwave-safe only. Use to cover food during cooking to retain moisture. Do not allow plastic wrap to touch food.
Thermometers	Microwave-safe only (meat and sugar thermometers)
Wax paper	Use as a cover to prevent splattering or as a wrap during steaming.

## Materials to avoid using in the microwave oven

Utensils	Remarks
Aluminum tray	May cause arcing. Transfer food into microwave-safe dish.
Food carton with metal handle	May cause arcing. Transfer food into microwave-safe dish.
Metal or metal-trimmed utensils	Metal shields the food from microwave energy. Metal trim may cause arcing.
Metal twist ties	May cause arcing and could cause a fire in the oven.
Paper bags	May cause a fire in the oven
Plastic foam	Expanded polystyrene may melt or contaminate the liquid inside when exposed to high temperature.
Wood	Wood will dry out when used in the microwave oven and may split or crack.



## Utensils

### CAUTION

#### Personal Injury Hazard

Tightly-closed containers could explode. Closed containers should be opened and plastic pouches pierced before cooking. See above for further instructions "Materials you can use in microwave oven or to be avoided in microwave oven." There may be certain non-metallic utensils that are not safe to use for microwaving. If in doubt, you can test the utensil in question by following the procedure below.

Utensil test:

1. Fill a microwave-safe container with 1 cup of cold water (250ml) along with the utensil in question.
2. Cook on maximum power for 1 minute.
3. Carefully feel the utensil. If the utensil is warm, do not use it for microwave cooking.
4. Do not exceed 1 minute cooking time.

## Setting Up Your Oven

If you have damaged or missing parts, call the Customer Helpline: 0345 640 3030

Please familiarize yourself with the parts and accessories listed below

Note : Remove the oven and all the materials from the carton

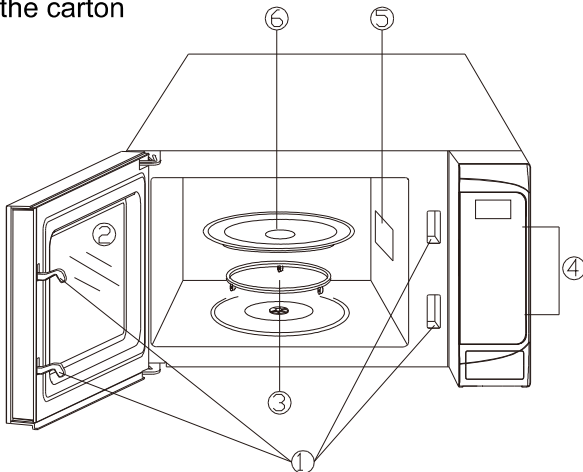

1. Door Safety Lock System
2. Oven Window
3. Turntable Roller
4. Control Panel
5. Mica Cover  
(Please do not remove the mica cover covering the wave guide)
6. Glass Turntable

## Turntable Installation

(A) Turntable Roller, (3) To be placed in the centre of the oven to support the glass plate.

(B) Glass turntable, To be placed on the turntable roller.

- a. Never place the glass turntable (6) upside down. The turntable should never be restricted in movement.
- b. Both glass turntable (6) and turntable roller (3) must always be used during cooking.
- c. All food and containers of food should always be placed on the glass tray for cooking.
- d. The glass turntable rotates clockwise or anti-clockwise randomly, this is normal.
- e. If glass turntable or turntable ring cracks or breaks, contact your nearest authorized service centre.

Warning : Do not remove the light brown Mica cover that is attached to the oven cavity to protect the magnetron.

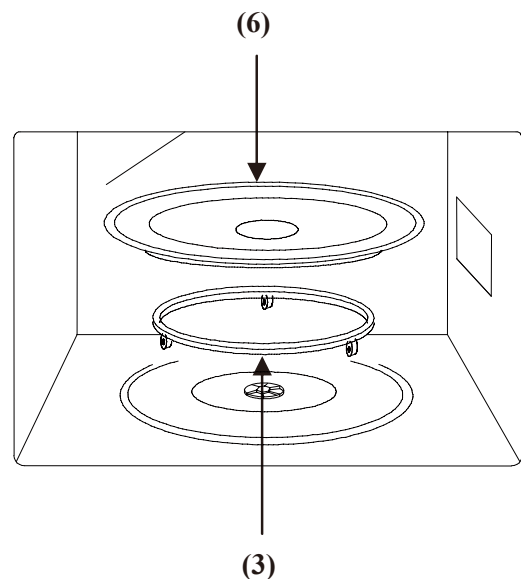

# Setting Up Your Oven

## Microwave Cooking Principles

1. This microwave generated by the magnetron are evenly distributed through the food as the glass turntable revolves. This ensures that the food is cooked uniformly.
2. The microwaves are absorbed by the food up to a depth of approximately 1 inch (2.5cm). Cooking continues as the heat is dissipated through the food.
3. Cooking times will vary according to the recipe and the density, weight and water content of the food. The cooking time will also vary according to the temperature at the start cooking, i.e. depending on whether the food is frozen or not.

## Microwave Food Packaging Symbols

Microwave Symbols :

On the front of your oven there is a microwave symbol, as shown below. This symbol has been introduced for your benefit when cooking or reheating packaged food.

Packaged food is also increasingly using a microwave symbol similar to the one below.

When you see this symbol on food packaging the cooking instructions are based on either IEC Power Output Rating, on the Reheating Categories A,B,C,D or E.

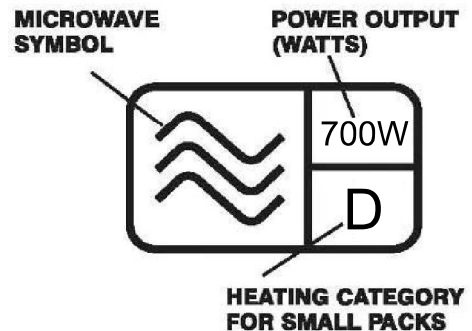

A, B, C, D or E

MORE HEATING TIME

LESS HEATING TIME

## Accessories included

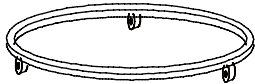

Turntable Roller



Glass Turntable

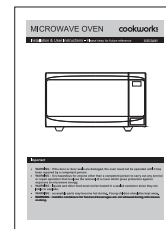

Instruction

# Installation

## Please note Electrical connection

This oven is fitted with a plug and must be only connected to a properly installed earthed socket. In accordance with the appropriate regulation, the socket must only be installed and the connecting cable must only be replaced by a qualified electrician. If the plug is no longer accessible following installation and all-pole isolating switch must be present on the installation side with a contact gap of at least 3mm.

1. Select a level surface that provide enough open space for the intake and / or outlet vents.

A minimum clearance of 3.0 inches (7.5cm) is required between the oven and any adjacent walls. One side must be open.

- (1) Leave a minimum clearance of 12 inches (30cm) above the oven.
- (2) Do not remove the legs from the bottom of the oven.
- (3) Blocking the intake and/or outlet openings can damage the oven.
- (4) Place the oven as far away from radios and TV as possible. Operation of microwave oven may cause interference to your radio or TV reception.

2. Plug your oven into a standard household outlet. Besure the voltage and the frequency is the same as the voltage and the frequency on the rating label.

**WARNING :** Do not install oven over a range cooktop or other heat-producing appliance. If installed near or over a heat source, the oven could be damaged and the warranty would be void.

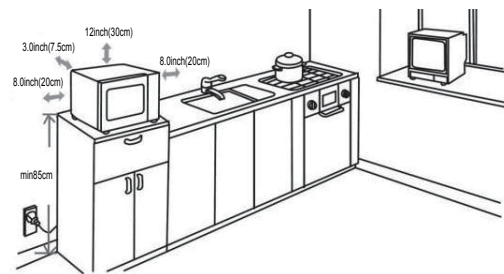

# Installation

## EARTHING INSTALLATION

### DANGER

Electric Shock Hazard

Touching some of the internal components can cause serious personal injury or death. Do not disassemble this appliance.

### WARNING

Electric Shock Hazard

Improper earthing can result in electric shock.

Do not plug into an outlet until appliance is properly installed and earthed.

Three pin earthed plug Properly polarised and earthed outlet.

This appliance must be earthed. In the event of an electrical short circuit, grounding reduces the risk of electric shock by providing an escape wire for the electric current. This appliance is equipped with a cord having a grounding wire with a earthing plug. The plug must be plugged into an outlet that is properly installed and earthed.

Consult a qualified electrician or serviceman if the earthing instructions are not completely understood or if doubt exists as to whether the appliance is properly earthed. If it is necessary to use an extension cord, use only a 3-wire extension cord that has a 3 pin earthing plug, and a 3-slot socket which will accept the plug.

1. A short power-supply cord is provided to reduce the risks resulting from becoming entangled in or tripping over a longer cord.
2. If an extension cord is used:
  - a. The marked electrical rating of the extension cord should be at least as great as the electrical rating of the appliance.
  - b. The extension cord must be earthed, a 3-wire cord.
  - c. The extension cord should be arranged so that it will not drape over the worktop or tabletop where it can be pulled on by children or tripped over accidentally.

Check that the voltage marked on the product corresponds with your supply voltage.

This product is fitted with a 13 A plug complying with BS1363. If this plug is unsuitable or needs to be replaced, please note the following:

**Important:**The wires in the mains lead are coloured in accordance with the following code:

GREEN / YELLOW – EARTH,  
BLUE – NEUTRAL, BROWN – LIVE

For UK use only

Plug fitting details (where applicable):

As the colours of the wires in the mains lead of this appliance may not correspond with the coloured markings identifying the terminals in your plug proceed as follows: The GREEN/YELLOW wire is the EARTH and must be connected to the terminal which is marked with the letter (E) or by the earth symbol or coloured GREEN or GREEN/YELLOW.

The BLUE wire is the NEUTRAL and must be connected to the terminal marked with the letter (N) or coloured BLACK.

The BROWN wire is the LIVE and must be connected to the terminal marked with the letter (L) or coloured RED.

Always ensure that the plug cord grip is fastened correctly. If a 13A (BS 1363) fused plug is used it must be fitted with a 13A fuse conforming to BS1362 and be ASTA approved. If in doubt contact a qualified electrician.

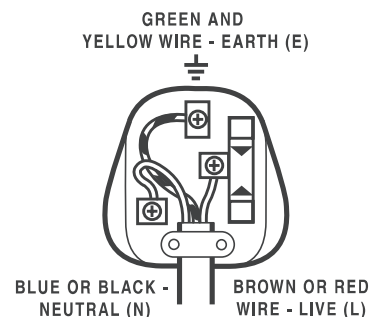

# Operating Your Microwave Oven

## Control Panel

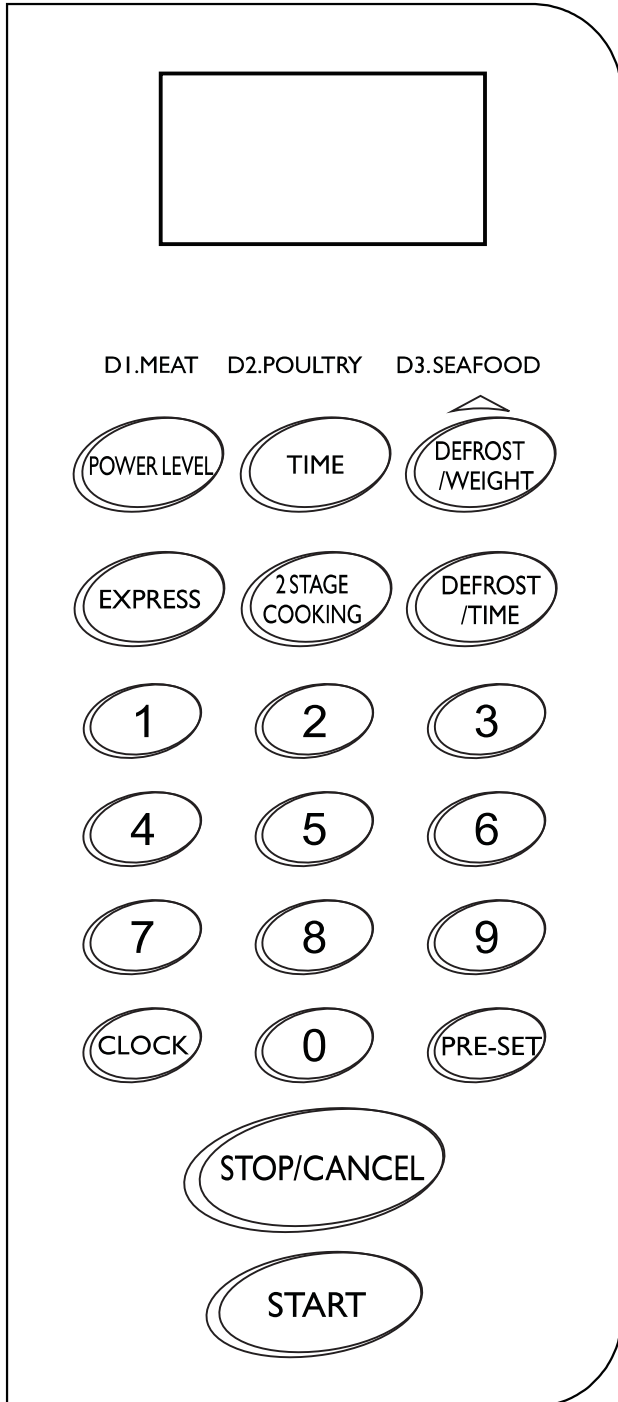

### DISPLAY

Cooking time, power, indicators and present time are displayed.

### NUMBER PADS (0-9)

Touch to enter time, power or weight.

### POWER LEVEL

Use to set microwave power level.

### DEFROST/WEIGHT

Use to defrost frozen meat, poultry and seafood by weight.

### DEFROST/TIME

Touch to set defrost program by time.

### TIME

Use to set cooking time.

### EXPRESS

Use this feature to program the oven for 4 popular microwave timings at HIGH power.

### 2STAGE COOKING

Use the MEMORY pad when setting multi-stage cooking program. The respective lights will come on to indicate which stage the oven is operating in.

### PRE-SET

Use to set the oven to start-up at a later time.

### CLOCK

Use to set the time of day or recall the time of day.

### START

Touch to start the cooking or defrosting programs.

### STOP/CANCEL

Touch to clear the selected power level, cooking or defrosting time that previously programmed. But the time of day clock cannot be cancelled. It is also used to set child lock.

# Operating Your Microwave Oven

## Setting the Clock

Your microwave oven is equipped with a clock, you must set the clock when you first install your oven or after a power failure.

1. In standby mode, press **CLOCK**, then press **STOP/CANCEL**.
2. Press NUMBER PAD to adjust the hour and the minute.
3. Press **CLOCK** to confirm the setting and the “:” will start to flash.

For example, set the current time to “6:30”.

1. Press **CLOCK** then press **STOP/CANCEL** is displays “:0”.
2. Continue to press 6.3.0 until it displays 6:30.
3. Press **CLOCK** to confirm the setting.

## Microwave Cooking

To cook with microwave, time and power level should be set. The maximum cooking time is 99:99 .

1. Press **POWER LEVEL** and NUMBER PADS to select the desired power level.
2. Press **TIME** once.
3. Continue to press NUMBER PADS, to adjust the cooking time.
4. Press **START** to start the cooking.

Example: Setting cooking time of 5 minutes on power 60%.

1. Press **POWER LEVEL** once then press number 6 and then it displays “P6” & “1S”.
2. Press **TIME** once and it displays “:0” & “1S”.
3. Press number 5,0,0, and it displays “5:00” “1S”.
4. Press **START** to start cooking.

When the cooking is finished, the oven will display END and beep three times. Press the any button or open the oven door to clear END before starting another cooking function.

### Microwave power chart

Number Pad	Microwave Power Level	Display
0	0%	P0, 1S
1	10%	P1, 1S
2	20%	P2, 1S
3	30%	P3, 1S
4	40%	P4, 1S
5	50%	P5, 1S
6	60%	P6, 1S
7	70%	P7, 1S
8	80%	P8, 1S
9	90%	P9, 1S
10	100%	P10, 1S

# Operating Your Microwave Oven



Note: always remember that cooking instructions are intended only as a guide. If you have followed the instructions and the food is still not piping hot throughout, simply return it to the oven and cook it until it is.

## Express

In the standby mode, press the  button once, the oven will start to cook with 100% power for 15 sec.

Each additional press the  button will increase the cooking time. The maximum cooking time is 2 mins.

Example: To cook for 1 minute with 100% power



1. Press  the three times then “1:00” will appear in the display.
2. Press .

Noted: The cooking time can be adjusted in following increments

PRESS ONCE..... 15 seconds  
PRESS TWICE..... 30 seconds  
PRESS 3 TIMES..... 1 minute  
PRESS 4 TIMES..... 2 minutes



## Weight Defrost

The oven allows the defrosting food based on the weight you entered. The time and defrosting power are adjusted automatically once the weight is programmed. The maximum weights of foods are as below:

FOOD CATEGORY	MAXIMUM WEIGHT	DISPLAY
Meat	2300g	d1 
Poultry	4000g	d2 
Seafood	900g	d3 

Operating Your Microwave Oven

Example: to defrost 600g shrimp.









1. Press  3 times. “d3”,  will appear in the display.
2. Continue to press “ NUMBER PAD 6,0,0,” to select the weight 600g.
3. Press .

# Operating Your Microwave Oven

## Multi-stage Cooking

The oven can be set up to 2 stage cooking and 3 stage cooking(only when Jet defrost and Weight defrost are set as the first stage).

Example:  for 5 mins, cook with 60% microwave power for 10 minutes and 100% power for 5 minutes.



1. Press  and the LED displays **\*\*** & **":0"**.
2. Press NUMBER PAD 5,0,0 and it displays 5:00 **\*\***
3. Press  and the LED display **:"1S"**
4. Press  once then press 6 until it displays **"1S", "P6"**
5. Press  and it displays **"1S", "0"**
6. Press 1.0.0.0.then it displays 10:00,1S
7. Press  and it will display **"2S"**.
8. Press  and it displays **P10,2S**
9. Press  once then press 5,0,0 until it displays: **"2S", "5:00"**
10. Press .

Note:

1. Jet Deforst and Weight Defrost can only be set in the first program.
2. Jet Deforst and Weight Defrost cannot be selected between or after the second or third program.
3. Express Cooking can not be set in multi-stage cooking program.
4. The respective lights will come on to indicate which stage the oven is operating in.

## Defrost / Time

The oven can quickly defrost food based on the time you entered. The maximum cooking time is 99:99.  
Example: to defrost shrimp for 5 minutes and 30 seconds.

1. Press  the once and the LED displays **":0"**& **\*\***
2. Press the NUMBER PAD. 5 ,3 ,0 and it displays **"5:30",& \*\***
3. Press  to start the cooking.

When the cooking is finished, the oven will display END beep three times until the oven door is opened or any button is pressed.

## Child lock

Lock: in standby state, touch  pad over 3 seconds, a "beep" will be heard denoting entering the child lock state, and the lock indicator "LOCK " will BE illuminated.

Unlock: In locked state, touch  pad over 3 second, a "beep" will be heard denoting entering the lock is released, and the locked indicator "LOCK " will disappear.









# Operating Your Microwave Oven

## Preset function

Please ensure the clock has been set. If the clock is not yet set, please follow section of “setting the clock” to set the clock before using this function. This function cannot be used if the clock is not yet set.

Example: Set cooking time at 2:00 for microwave cooking 100% power with 5mins.

1. Press  once and it display "1S", "P10"
2. Press  once and it displays "1S" & ":0"
3. Press 5.0.0 and it displays "5:00", 1S
4. Press  and it display ":0" 
5. Press 2.0.0 and it display "2:00" & 
6. Press  to confirm the setting and  is flashing,

When the times is arrived, the oven will start the cooking automatically.

### NOTE:

1. After preset function has been set up, press  to display the start time for the cooking.
2. While the preset function has been set up, the oven cannot operate for other cooking function.
3. Press “STOP/CANCEL” to cancel the preset function and the the cooking will go off.

# Operating Your Microwave Oven

## Warming Up and Heating

Times stated are approximate and can vary depending on the quality, size of the chopped pieces, storage temperature and moisture content of the foodstuff. It is advisable to set a shorter cooking time at first, and then if necessary continue the cooking process, until the food is cooked to your satisfaction.

Foodstuff	Quantity	Output Level	Time (Mins)	Remarks
<b>Liquids</b>				
Milk, 1 cup	150g	P100 (=100%)	0.5 - 1	Caution: Stir the liquid prior to and during heating/reheating, let liquid stand for at least 10 seconds after cooking and always take care when adding ingredients to hot liquids.
Water/Coffee /Milk 1 cup	150g	P100 (=100%)	1 - 2	Caution: Stir the liquid prior to and during heating/reheating, let liquid stand for at least 10 seconds after cooking and always take care when adding ingredients to hot liquids.
Water	500g	P100 (=100%)	3 - 5	Caution: Stir the liquid prior to and during heating/reheating, let liquid stand for at least 10 seconds after cooking and always take care when adding ingredients to hot liquids.
One-course meals/ Ready-to-serve meals	450g	P100 (=100%)	4 - 6	Cover.
Soups	250g	P100 (=100%)	1 - 2	Stir.
Stews	500g	P100 (=100%)	3 - 5	Stir between times.
<b>Meat / Poultry</b>				
Roast	250g	P100 (=100%)	2 - 3	
Rissoles/Meatballs	500g	P100 (=100%)	3 - 4	
1/2 Chicken	450g	P100 (=100%)	3 - 4	Lightly brush with oil.
<b>Vegetables</b>				
Portion x 1	150g	P100 (=100%)	1 - 2	Cover, stir.
Portions x 2	300g	P100 (=100%)	2 - 4	Cover, stir.
<b>Side Dishes</b>				
Noodles	150g	P100 (=100%)	1 - 2	Dampen slightly beforehand, cover, stir.
Rice	150g	P100 (=100%)	1 - 2	Dampen slightly beforehand, cover, stir.
Potatoes	500g	P100 (=100%)	3 - 4	Cover.
Baby Food	approx, 200g	P100 (=100%)	1 - 2	Stir well, check the temperature.
<b>Meat</b>				
Beef, Pork in one piece	500g	P 80 (=80%)	11 - 14	Cover, turn halfway through cooking, leave to stand for 3-5 minutes.
Lightly smoked pork loin	500g	P 80 (=80%)	12 - 15	
Meatloaf		P100 (=100%)	12 - 15	

Sausages	200g	P 80 (=80%)	(= 2 - 3	Pierce skin with fork.
Poultry				
Chicken	1000g	P100 (=100%)	20 - 25	Cover, turn once, leave to stand for 5 minutes.
Pieces of Chicken	250g	P80 (=80%)	4 - 5	
Fish				
Fresh fish	300g	P 80 (=80%)	(= 5 - 7	Cover, turn once, leave to stand for 3 minutes.
Fillet of fish	300g	P 80 (=80%)	(= 4 - 5	Cover, turn once, leave to stand for 3 minutes.
Frozen fish	400g	P100 (=100%)	8 - 10	Cover, leave to stand for 3 minutes.
Vegetables, fresh				
Cauliflower, fennel	broccoli, 150g	P100 (=100%)	8 - 10	Chop vegetables into small pieces, cook with liquid, (3-5 tablespoons), stir in between times leave to stand for 3-5 minutes, add spices, (salt before serving).
French beans	500g	P100 (=100%)	10 - 12	
Potatoes, potatoes	boiled 500g	P100 (=100%)	8 - 10	
Jacket potatoes	500g	P100 (=100%)	10 - 12	Prick the jacket for boiling potatoes.
Carrots	500g	P100 (=100%)	8 - 10	
Vegetables, frozen	deep			Take note of details on the packaging.
Leaf spinach	300g	P100 (=100%)	10 - 12	Cover, add some liquid, stir in between times, leave to stand for 3 - 5 minutes.
Peas	300g	P100 (=100%)	7 - 9	
Leeks	200g	P100 (=100%)	10 - 12	
Carrots	200g	P100 (=100%)	6 - 8	
Brussel sprouts	250g	P100 (=100%)	6 - 8	
Spinach	150g	P100 (=100%)+	3 - 4	
		P 30 (=30%)	(= 20 - 22	
Deserts				
Pudding/Flummery	500g	P100 (=100%)	6 - 8	

# Cleaning your Microwave Oven

## Attention

Your microwave oven should be cleaned regularly to prevent grease and food particles from building up on the inside surface. The accumulated grease /food particles may cause a fire hazard.

It's important to clean the interior of your microwave oven after each use.

To clean the oven interior, use a mild detergent solution, such as washing-up liquid, with warm water on a soft cloth.

It's suggested to place half a lemon in a bowl and add 300ml water inside the oven. Then heat it on 100% microwave power setting for 10 minutes. Wipe the oven clean with a soft , dry cloth.

### IMPORTANT:

ALWAYS switch off oven and unplug from power supply.

ALWAYS use a branded cleaning spray, and for stubborn spots inside the oven, spray a small amount of cleaner onto a damp cloth.

DO NOT SPRAY DIRECTLY INSIDE THE OVEN.

Removable Parts.

1.The turntable may be cleaned at the sink. Be careful not to clip or scratch the edges as this may cause the turntable to break during use.

2.The turntable roller should be cleaned regularly.

3.Do not immerse the turntable glass in cold water.

### Special Care

For best performance and safety, the inner door panel and the oven front frame should be free of food residue. To prevent damage to the operating parts inside the oven, water should not be allowed to seep into the ventilation openings.

# Trouble Shooting and Maintenance

## Normal Condition

Microwave oven interfering with TV reception.

Radio and TV reception maybe interfered with when microwave oven is operation. It is similar to the interference of small electrical appliances such as food mixers, vacuum cleaners and electric fans. This is normal .

Oven light dim.

In low power microwave cooking, oven light may become dim. This is normal.

Steam accumulating on door, hot air out of vents.

In cooking, steam may come out of food. Most will come out from vents but some may condense on cool places such as the oven door. This is normal.

Oven started accidentally with no food in.

Although starting the oven with no food in it should be avoided, it does no damage to the oven provided it is only operated empty for a very short time. It is advised that a glass or microwave safe container of water is always left in the oven to absorb any heat should the oven be turned on accidentally.

# Trouble Shooting

## Maintenance

Check for problems by using the chart below. If the microwave oven still does not work properly, contact the nearest authorised service centre.

PROBLEM	POSSIBLE CAUSE
<b>Oven will not start</b>	a. Plug not secure in power socket, or not switched on. b. Door is open. c. Wrong operation is set.
<b>Arcing or sparking</b>	a. Materials which should be avoided in microwave oven are used. b. The oven is operated when empty. c. Spilled food remains in the cavity.
<b>Unevenly cooked food</b>	a. Materials which should be avoided in microwave oven are used. b. Food is not defrosted completely. c. Power setting for cooking time is incorrect. d. Food is not turned or stirred.
<b>Overcooked food</b>	Power setting for cooking time is incorrect.
<b>Undercooked food</b>	a. Materials to be avoided in microwave oven are used. b. Food is not defrosted completely. c. Oven ventilation ports are restricted. d. Power setting for cooking time is incorrect.
<b>Incomplete defrosting</b>	a. Materials to be avoided in microwave oven are used. b. Power setting for cooking time is incorrect. c. Food is not turned or stirred.
<b>Noise comes from turntable when oven is turned on</b>	Food residue exists between the turntable roller rest and cavity bottom.
<b>Oven light does not glow</b>	a. The light bulb has burned out b. START has not been pressed.

## QUESTIONS AND ANSWERS

Q: When the oven is plugged into a wall outlet for the first time, it does not work properly. What's wrong?

A: The microcomputer used in the oven control may temporarily become scrambled and fail to function as programmed. Unplug the oven from the wall outlet and then plug it back in. The microcomputer will then reset for proper functioning.

Q: Why is there noise coming from the oven when using a lower power level?

A: When cooking with power other than 100%, the oven automatically switches on and off to obtain the correct power output. The clicking noise can be heard when the oven switches on and off. This is normal

Q: Why is there steam coming out of the air exhaust vent?

A: Steam is produced during cooking. The microwave oven has been made to vent this steam.

Q: What is wrong when the oven light will not glow?

A: There may be several reasons why the oven light will not glow. The light bulb has burned out or START has not been pressed.

Q: Why do eggs sometimes burst?

A: The egg yolk may burst because of steam build-up inside the membrane. Pierce the membrane with a toothpick before cooking it. Never microwave eggs in the shell as they may explode.

Q: How is boiling over avoided?

A: Use a larger utensil than usual for cooking. If you open the oven door or touch STOP/CLEAR, the food will stop boiling.

## IMPORTANT NOTES

1. Before first using this oven please read this instruction manual and keep it carefully.
2. Do not attempt to repair the oven yourself, please consult an authorised expert.
3. Check the oven and the cable regularly for damage. If there is any kind of damage, the oven should not be used.

Warning:

- a. It is hazardous for anyone other than a trained person to carry out any service or repair operation which involves the removal of any cover which gives protection against exposure to microwave energy.
- b. Never allow children to use the oven without supervision unless adequate instructions have been given so that the children are able to use the oven in a safe way and understand the hazards of improper use.
- c. If the supply cord is damaged, it must be replaced by the manufacturer or its service agent or a similarly qualified person in order to avoid a hazard.

NOTE

- Do not attempt to operate this oven with the door open since open-door operation can result in harmful exposure to microwave energy. It is important not to try and override or tamper with the safety interlocks.
- Carefully clean door seals and sealing surfaces.
- Do not operate the oven if it is damaged. It is particularly important that the oven door closes properly and that there is no damage to the, (1) door (i.e. door is not bent or dented), (2) hinges and latches (broken or loosened), (3) door seals and sealing surfaces.
- Utensils should be checked to ensure that they are suitable for use in microwave ovens.
- If the door or door seals are damaged the oven must not be operated until it has been repaired by a trained person.
- Warning: Children less than 8 years of age shall be kept away unless continuously supervised.
- The temperature of accessible surfaces may be high when the appliance is operating. The surfaces are liable to get hot during use. Keep cord away from heated surface, and do not cover any events on the oven.
- Children should be supervised to ensure that they do not play with the appliance.
- The appliances are not intended to be operated by means of an external timer or separate remote-control system.

BULB REPLACEMENT

If the interior light bulb fails, it can be easily replaced by a qualified service engineer. Do not attempt to remove the outercasing, as this will expose live components. Please consult a qualified service engineer.

# Technical Specifications

Model	P70B17AP-S1
Power Source:	230-240V~ 50Hz
Microwave Power Consumption:	1200 Watt
Microwave Maximum Output:	700 Watt
Operation Frequency:	2450 MHz
Oven Capacity:	17 Litres
Turntable Diameter:	Ø 245 mm
External Dimensions (Hx W x D):	262×452×318 mm
Net Weight:	Approx. 10.5Kgs

We apologize for any inconvenience caused by any minor inconsistencies in these instructions, which may occur as a result of product improvements and development.

For future help, please call the customer helpline: 0345 640 3030.



The symbol on the product or its packaging indicates that this product may not be treated as household waste. Instead it should be handed over to the applicable collection point for the recycling of electrical and electronic equipment. By ensuring this product is disposed of correctly, you will help prevent potential negative consequences for the environment and human health, which could otherwise be caused by inappropriate waste handling of this product. For more detailed information about recycling this product, please contact your local council office, your household waste disposal service or the shop where the product was purchased.

# Guarantee



## PRODUCT GUARANTEE

This product is guaranteed against manufacturing defects for a period of



Year

This product is guaranteed for twelve months from the date of original purchase.

Any defect that arises due to faulty materials or workmanship will either be replaced, refunded or repaired free of charge where possible during this period by the dealer from whom you purchased the unit.

The guarantee is subject to the following provisions:

- The guarantee does not cover accidental damage, misuse, cabinet parts, knobs or consumable items.
- The product must be correctly installed and operated in accordance with the instructions contained in this manual.
- It must be used solely for domestic purpose.
- The guarantee will be rendered invalid if the product is re-sold or has been damaged by inexpert repair.
- Specifications are subject to change without notice.
- The manufacturer disclaims any liability for the incidental or consequential damages.
- The guarantee is in addition to, and does not diminish your statutory or legal rights.

Guarantor: Argos Ltd.  
489 - 499 Avebury Boulevard  
Central Milton Keynes  
MK9 2NW