





# ALBA

## 24" LED TV Instruction manual

Cat Number: 820/8732 (Black), 819/5003 (Pink), 804/8545 (White)





# Important Guarantee Information

Congratulations on purchasing this television. We hope you have many years of trouble free enjoyment from your purchase.

Your product is covered under the manufacturers guarantee for 12 months from the date of purchase.

If you experience any difficulties with your TV, please refer to the 'Frequently asked questions' section in this user guide.

If you are still unable to remedy the issue, try resetting the TV to factory settings. (Details in the 'Settings menu' section of this user guide). Alternatively you can contact the helpline on the number below.

In the event that a fault is diagnosed, the helpline will arrange to collect the TV from your home or work address, return it to our service centre, repair the item and then return it to you.

If we believe we cannot offer a permanent repair, we will replace the item.

## Helpline Information

Helpline 0345 604 0105

**The Helpline is open 8am-7pm Monday to Saturday & 10am-4pm Sunday.** (Calls are charged at the standard rate of your network provider.)

You must retain all packaging materials, in addition to your proof of purchase/receipt, as you will need these in the event of warranty/service support.

This guarantee is in addition to and does not affect your statutory rights.

If you need to call the helpline, you will need the following information.

1) Model Ref \_\_\_\_\_ (You can find this on the rear of the TV)

2) Date of purchase \_\_\_\_\_ (You can find this on your sales receipt)

3) Serial Number \_\_\_\_\_ (You can find this on the rear of the TV)

## EXAMPLE OF LABEL ON REAR OF TV

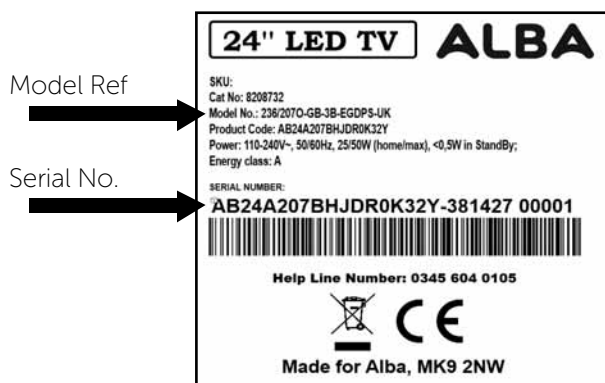

This TV is for domestic use only



If you require any technical guidance or find that your TV is not operating as intended, a simple solution can often be found in the **Troubleshooting** section of these instructions.



# Contents

## 1 Safety information

Safety information 8-11

## 2 Getting to know your TV

Accessories 14

Stand installation 15

Detaching the stand 16

Securing the TV with anti-tip straps 16

Wall mounting 17

TV buttons 18

Remote control 19

## 3 Connections

TV buttons and input source 22

TV connections 23-24

## 4 Standard features

How to navigate the menus 28

Channel menu 29

Picture menu 30

Sound menu 31

Time menu 32

System/hotel lock menu 32

Settings menu 33

## 5 Advanced features

7 day TV guide 36

USB media player 37

USB Record 38-39

DVD setup 40

## 6 Product support

Connecting a sky digital set top box 44-45

Frequently asked questions 46-47

Technical specification 48-49

Alba warranty information 50



For DTS patents, see <http://patents.dts.com>. Manufactured under license from DTS Licensing Limited. DTS, the Symbol, & DTS and the Symbol together are registered trademarks, and DTS TruSurround is a trademark of DTS, Inc. © DTS, Inc. All Rights Reserved.

If you still require further assistance, call one of our experts on 0345 604 0105. (Calls are charged at the standard rate of your network provider).





# Safety information

1





## Safety information

**Important** - Please read these instructions fully before installing or operating



### Warnings

- Television sets with 40" screens or more must be lifted and carried by at least 2 people.
- This television does not contain any parts that are serviceable by the user. In case of a fault, contact the manufacturer or authorised service department. Exposing the internal parts inside the TV may endanger your life. The manufacturer's guarantee does not extend to faults caused by repairs carried out by unauthorised third parties.

To prevent the spread of fire, keep candles or other open flames away from this product at all times



- Do not use TV set immediately after unpacking. Wait until TV warms up to the room temperature before using it.
- To reduce the risk of fire, electric shock or damage to the TV, do not expose it to dust, rain or moisture. Never expose the TV to dripping or splashing and do not place objects filled with liquids on or near the TV.
- Do not connect any external devices (DVD player, games console etc) when the TV is switched on. Disconnect both the TV and device from the mains before connecting. Only switch appliances on when the connection process is complete.
- Do not place the television in a confined space and do not obstruct the ventilation openings at the rear of the television.
- When installing on a wall, ensure the TV is at least 5cm from the wall for ventilation.
- Always ensure that the TV's ventilation openings are not covered with items such as newspapers, table-cloths, curtains, etc.
- Dispose of this television and any components including batteries in an environmentally friendly manner. If in doubt, please contact your local authority for details of recycling.

- Ensure this TV is used in moderate climates only.
- In case of electrostatic discharge (ESD) the TV may display incorrect functions. In such case, switch the TV off and switch the TV back on. The TV will work normally.

**WARNING: Never place a television set on an unstable location. A television set may fall, causing serious personal injury or death. Many injuries, particularly to children, can be avoided by taking simple precautions such as:**

- Use cabinets or stands recommended by the manufacturer of the television set.
- Only use furniture that can safely support the television set.
- Ensure the television set is not overhanging the edge of the supporting furniture.
- Do not place the television set on tall furniture (for example, cupboards or bookcases) without anchoring both the furniture and the television set to a suitable support.
- Do not place the television set on cloth or other materials that may be located between the television set and supporting furniture.
- Please educate children about the dangers of climbing on furniture to reach the television set or its controls.
- If your existing television set is being retained and relocated, the same considerations as above should be applied.

### Safety

- For your safety, this appliance is fitted with a fused 3 pin mains plug. Should the fuse need to be replaced, ensure that any replacement is of the same amperage and approved with the BSI mark.
- Never try and replace the mains plug unless you have adequate qualifications and are legally authorised to do so. In the event that a replacement mains cable is required, contact the manufacturer for a suitable replacement.
- Never use the television if it is damaged in any way.
- Always place the television on a flat level surface avoiding anywhere which may be subject to strong vibration.

If you require any technical guidance or find that your TV is not operating as intended, a simple solution can often be found in the **Troubleshooting** section of these instructions.





## Safety information

**Important** - Please read these instructions fully before installing or operating

- The ideal distance to watch the television is approximately five times the length of the diagonal measurements of the TV screen.
- Ensure the television is not placed on top of the power cable as the weight of the television may damage the cable and cause a safety hazard.
- Never place mobile phones, speakers or any other device which may cause magnetic or radio interference, near the television. If interference is apparent, move the device causing the interference away from the television.
- To disconnect the set from the mains, remove the mains plug from the socket.
- Ensure that the mains plug is always easily accessible.

**WARNING: Excessive noise when using earphones and headphones can cause loss of hearing.**

### Maintenance

- To clean your TV, wipe with a soft, dry cloth. If the surfaces are extremely dirty, use a soft cloth dipped in a soap and water solution or a weak detergent solution.
- Never use alcohol, paint thinner or benzene to clean this unit.
- Before using a chemically treated cloth, read the instructions that came with the cloth carefully.

**CAUTION: If water or other liquid enters the television through the display panel surface, a malfunction may occur.**



### Packaging

- The safest way to transport your item is in the original box/packaging - please save your packaging for this.
- You will need the original box/packaging in the event of warranty/service repair or support. We are unable to carry out warranty/service if you are unable to package the item correctly.

### Important information regarding use of video games, computers, captions or other fixed image displays

- The extended use of fixed image program material can cause a permanent "shadow image" on the LCD/LED panel, also known as "screen burn".
- This "shadow image" can appear in the background during normal viewing. This type of irreversible LCD/LED panel deterioration can be limited by observing the following steps:
  1. Reduce the brightness/contrast setting to a minimum suitable viewing level.
  2. Do not display the fixed image for extended periods of time.
  3. Turn the power off when not in use.
- Examples of images that are more likely to cause "screen burn" are as follows (this is not an exhaustive list):
  - TV channel logos: e.g. shopping channel logos and pricing displays - especially if they are bright and stationary. Moving or low-contrast graphics are less likely to cause ageing of the screen.
  - Time displays.
  - Teletext: Do not view a stationary page for a long period of time
  - TV/DVD menus: e.g. listings of DVD disc content.
  - Pause mode: Do not leave the TV in pause mode for long periods of time, e.g. when watching DVDs or videos.

**Important: Once 'shadow image/screen burn' occurs, it will never disappear and is not repairable under warranty.**

If you still require further assistance, call one of our experts on **0345 604 0105**. (Calls are charged at the standard rate of your network provider).



## Safety information

**Important** - Please read these instructions fully before installing or operating

### Disposal

**UK:** Waste electrical products should not be disposed of with household waste. Please dispose of the product at a designated collection point for recycling of WEEE. For your nearest facilities, please see [www.recycle-more.co.uk](http://www.recycle-more.co.uk) or in store for details.

**ROI:** Waste electrical products should not be disposed of with household waste. Separate disposal facilities exist. Check with your local authority or retailer for recycling advice.

### Batteries

- Do not expose batteries to high temperatures, excessive heat, prolonged sunshine or fire as this may cause leakage, explosion or ignition. Observe the correct polarity when inserting batteries.
- Do not use different types of batteries together or mix old and new batteries.
- Dispose of batteries in an environmentally friendly way.
- Certain regions may regulate the disposal of batteries. Please consult your local authority.

### Trademarks

#### HDTV 1080p

The "HD TV 1080p" Logo is a trademark of DIGITALEUROPE.

#### FREEVIEW HD

The FREEVIEW HD words and logos are trade marks of DTV Services LTD. © DTV Services Ltd.

#### SAORVIEW

SAORVIEW is a registered trademark owned by RTÉ.

#### DVB

The DVB logo is the registered trademark of the Digital Video Broadcasting - DVB – project.



Manufactured under license from Dolby Laboratories. Dolby, Dolby Audio, and the double-D symbol are trademarks of Dolby Laboratories.



The terms HDMI and HDMI High-Definition Multimedia Interface, and the HDMI Logo are trademarks or registered trademarks of HDMI Licensing, LLC in the United States and other countries.



The "CI plus" Logo is a trademark of CI Plus LLP.



For DTS patents, see <http://patents.dts.com>. Manufactured under license from DTS Licensing Limited. DTS, the Symbol, & DTS and the Symbol together are registered trademarks, and DTS TruSurround is a trademark of DTS, Inc. © DTS, Inc. All Rights Reserved.

---

Hereby, Universal Media Corporation l.t.d. declares that this LED TV is in compliance with the essential requirements and other relevant provisions of RED Directive 2014/53/EU.

---

## TV Models with built in DVD players

### CAUTION:

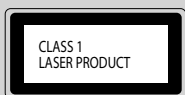

This unit is a class 1 laser product. This unit uses a visible laser beam which could cause hazardous radiation exposure if directed. Be sure to operate the player correctly as instructed.

When this unit is plugged into the wall outlet, do not place your eyes close to the openings to look into the inside of this unit.

Use of controls or adjustments or performance of procedures other than those specified herein may result in hazardous radiation exposure.

Do not open covers and do not repair yourself. refer servicing to qualified personnel.





# Getting to know your TV

# 2

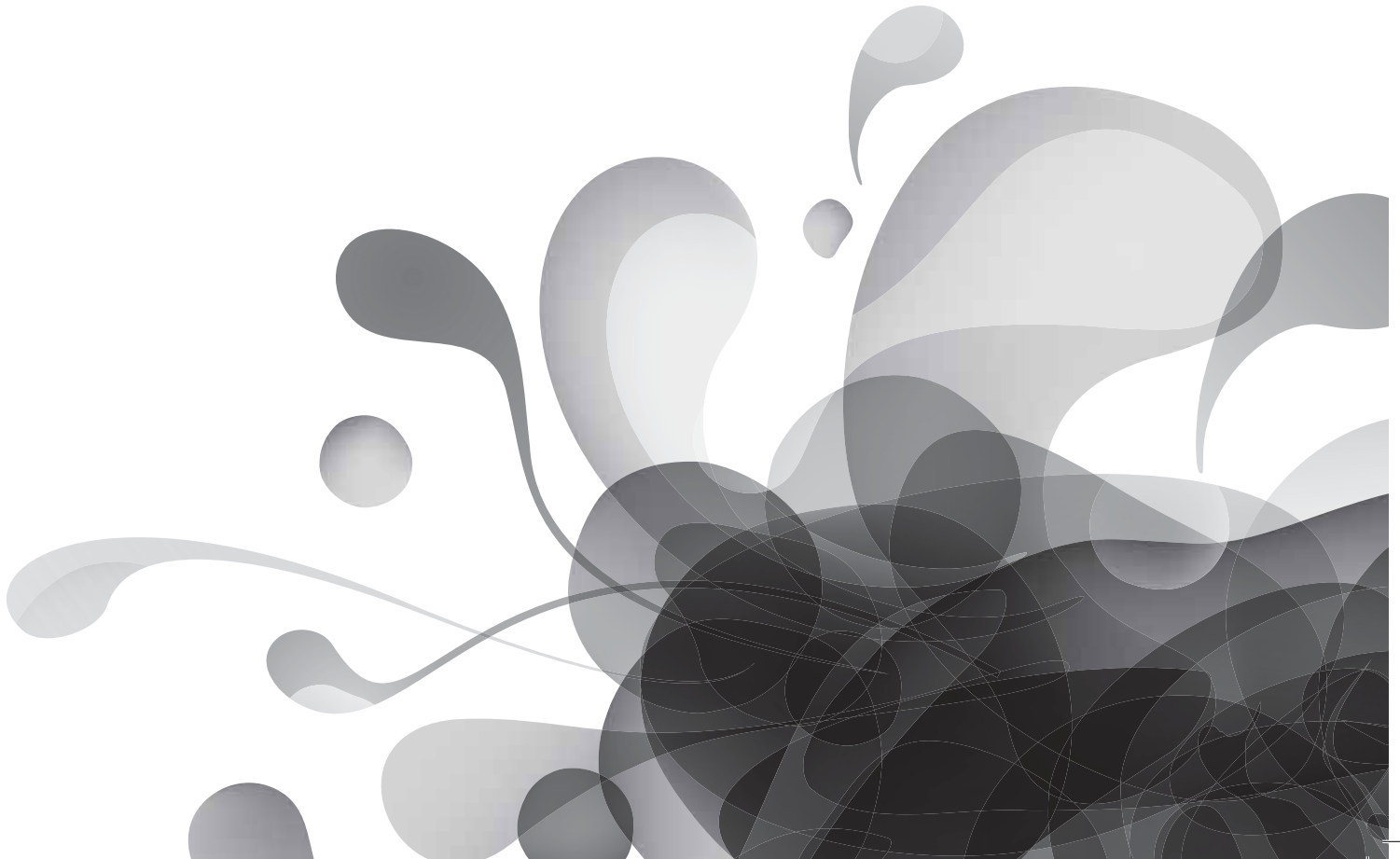

# Getting to know your TV

You'll be up and running in no time

## Accessories

1 x User guide

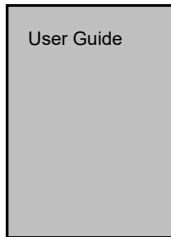

1 x Quick start guide



1 x TV



1 x RF cable



1 x Remote control & 2 x AAA batteries



1 x Stand installation pack

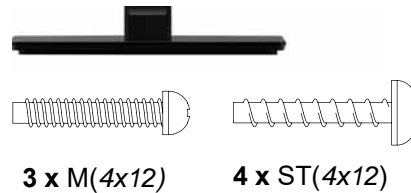

1 x Mini Component / YPbPr Cable



1 x mini-AV Cable



Note: Please save your box/packaging as you will need this in the event of warranty/service repair or support. We are unable to carry out warranty/service if you are unable to package it correctly. The safest way to package your item in the event of warranty/service repair is in its original box/packaging.

If you require any technical guidance or find that your TV is not operating as intended, a simple solution can often be found in the **Troubleshooting** section of these instructions.

# Getting to know your TV

You'll be up and running in no time

## Stand installation

To complete the stand installation you will require a cross head screw driver.

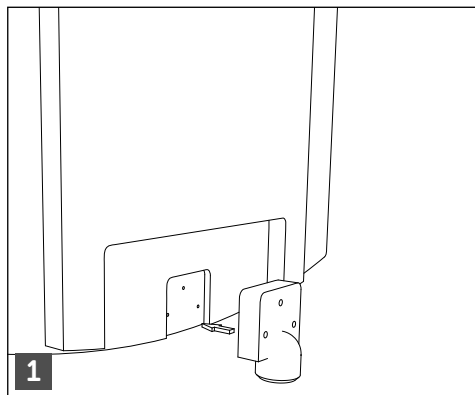
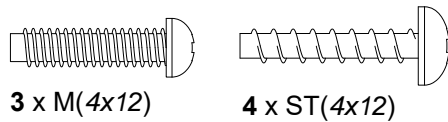

**fig 1)** Attach the stand neck to the rear of the TV set.

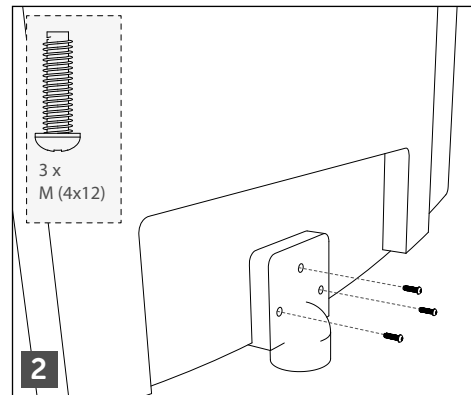

**fig 2)** Secure the neck to the TV using the 3 x M(4x12) screws provided.

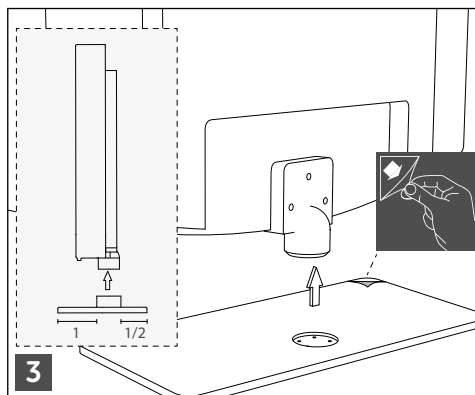

**fig 3)** Peel off the protective plastic cover then attach the stand base to the neck.

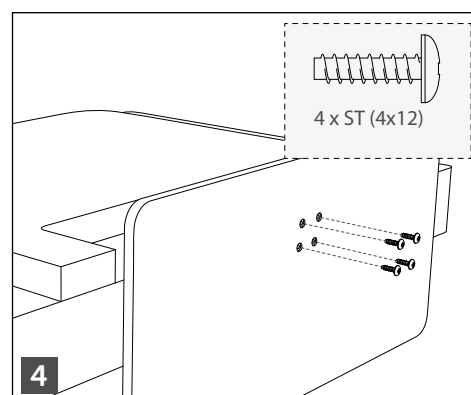

**fig 4)** Secure the base to the neck using the 4 x ST(4x12) screws provided.

### Helpful advice for first time stand installation

When securing the self-tapping screw/s into the base of the TV (on first installation) the screw/s may be naturally tight as they create a thread in the plastic.

- Ensure the cross head screw driver tip fits correctly into the head of the screw and that it is not too big or small.
- Screw in all screws individually and partially before tightening all of the screws fully.
- If the screws become very tight try loosening and re-tightening, this will continue the process of creating the thread.

If you still require further assistance, call one of our experts on 0345 604 0105. (Calls are charged at the standard rate of your network provider).

# Getting to know your TV

You'll be up and running in no time

## Detaching the stand

To detach the stand please remove the **3** screws highlighted then remove the stand feet from the rear of the TV set.

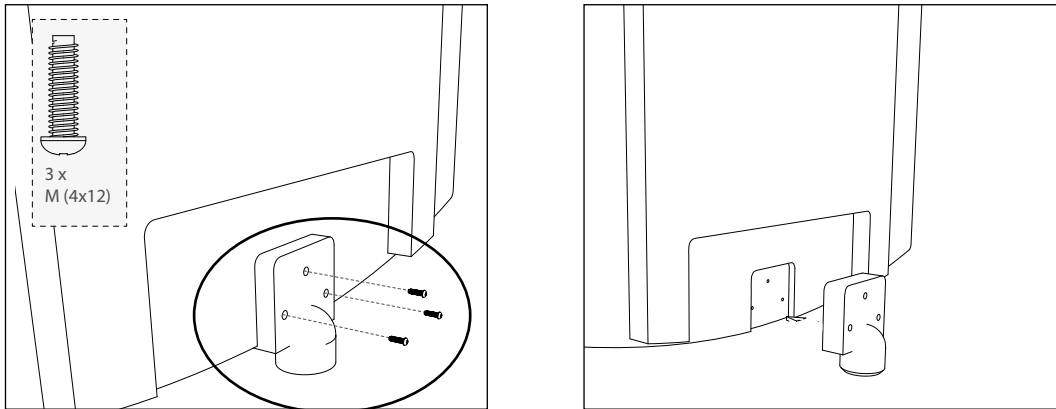

## Securing the TV using anti-tip straps

For maximum security in the home, when using a TV with its stand, anti-tip straps should be fitted. These are available from supermarket websites and other websites and are an easy, inexpensive and effective way of ensuring your TV stays safely upright. Straps are designed to be attached to the rear of the TV and then tethered to the wall or the furniture the TV is stood on, these are fitted as follows.

**NOTE:** Please ensure that children do not climb on the TV set.

- A)** Using one or both of the top wall-mounting holes and screws fasten one end of the fastening cord/s to the TV. (the screws are already supplied in the wall mounting holes)
- B)** Secure the other end of the fastening cord/s to your wall. (you will need screws/fixings suitable for your wall type - available separately from most DIY stores.

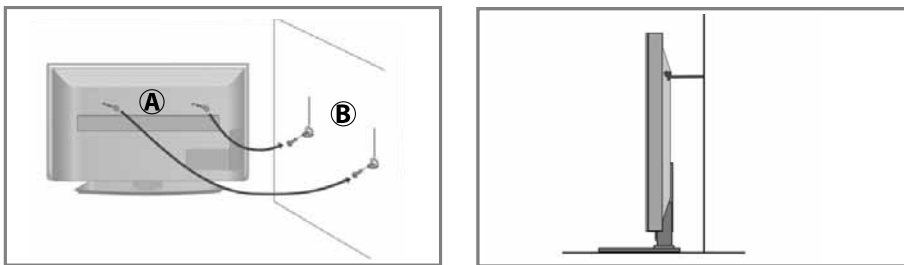

The Royal Society for the Prevention of Accidents is urging people to take care with flat-screen televisions. RoSPA stated in 2010 that "Toddlers are particularly at risk of pulling flat-screen televisions on to themselves. They are unsteady on their feet and are attracted by colourful television images." The risk is increased as televisions become lighter.

If you require any technical guidance or find that your TV is not operating as intended, a simple solution can often be found in the **Troubleshooting** section of these instructions.



# Getting to know your TV

You'll be up and running in no time

## Wall mounting

**IMPORTANT:** Before drilling any holes in the wall ensure you are not drilling where there could be any electric wires, water or gas pipes.

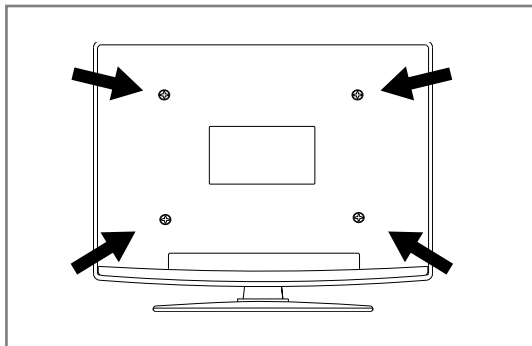

- 1) Remove the four screws located at the back of the TV set.
- 2) The wall mount can now be easily attached to the mounting holes, located on the back of the TV, using the same four screws removed.

**IMPORTANT:** If wall mounting this TV, only use the screws already provided in the wall mounting holes. Using other screws which are longer could cause irreparable damage to internal parts.

For optimum viewing, if wall mounting the TV higher than eye level, the TV should be tilted downwards so that the TV's screen is 'face on'. See fig 1 and 2 below.

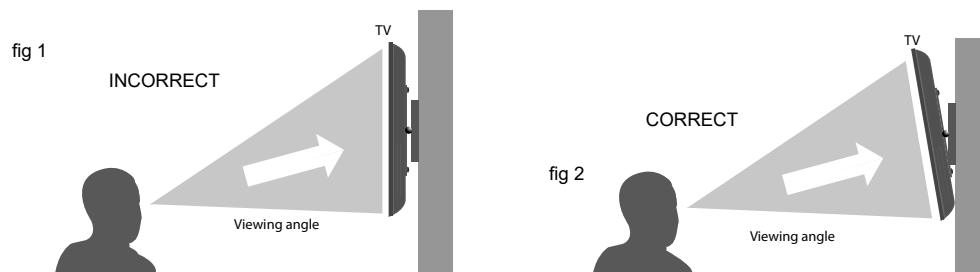

For VESA wall mounting information please refer to the Technical Specification page.

If you still require further assistance, call one of our experts on 0345 604 0105. (Calls are charged at the standard rate of your network provider).

# Getting to know your TV

You'll be up and running in no time

## TV buttons and input source

For models with built in DVD player

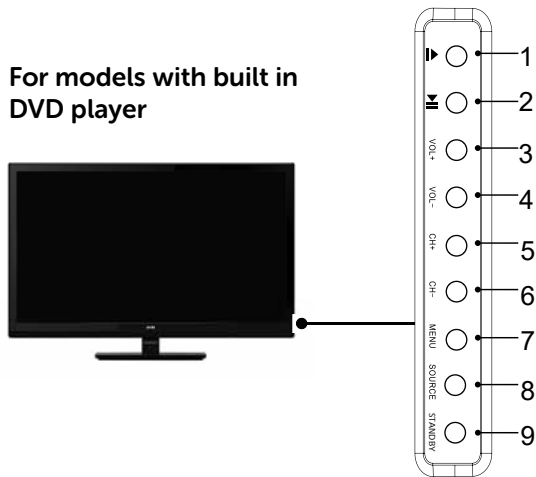

- 1) Stop/Eject DVD
- 2) Play/Pause DVD
- 3) Volume up and menu right
- 4) Volume down and menu left
- 5) Programme/Channel up and menu up
- 6) Programme/Channel down and menu down
- 7) Displays Menu/OSD
- 8) Displays the input source menu
- 9) Standby Power On/Off

## Choosing mode and input/source

To switch between the different input/connections.

### A) Using the buttons on the remote control:

- 1) Press [SOURCE] - The source menu will appear.
- 2) Press [V] or [∧] to select the input you require.
- 3) Press [OK].

### B) Using the buttons on the Television:

- 1) Press [SOURCE].
- 2) Scroll up / down using CH+/ CH- buttons to the input/source you require.
- 3) Press Vol+ to change input/source to the one selected.

For further information on input/connections please view 'Connections' pages.

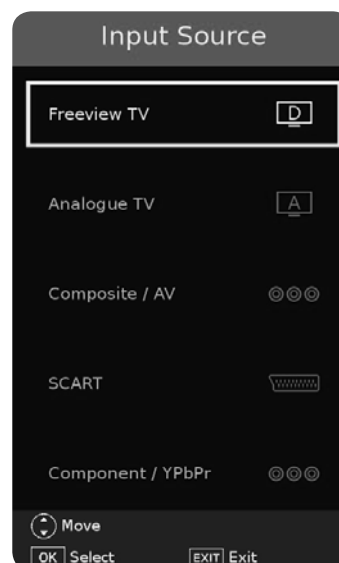

Example of Source menu depending on the TV model

If you require any technical guidance or find that your TV is not operating as intended, a simple solution can often be found in the **Troubleshooting** section of these instructions.

# Getting to know your TV

You'll be up and running in no time

## Remote control functions

For Models with Integrated DVD players

For Models with PVR Function

For Models with USB Playback

For Models with 3D Feature

1) STANDBY

2) MUTE

3) DTV

4) RADIO

5) DVD

6) USB

7) NUMBER BUTTONS

8) TV GUIDE

9) - To return to the previous channel viewed

10) P.MODE - Scrolls through picture mode options

11) VOL

12) CH

13) S.MODE - Scrolls through sound mode options

14) FAV - To display favourites menu

15) MENU

16) EXIT

17) (OK) - Allows you to navigate the on-screen menus and adjust the system settings to your preference

18) SOURCE/AV

19) INFO - Press once for now/next channel information. Press twice for programme information about current programme

20) ASPECT

21) SLEEP

22) SUBTITLE

23) AUDIO

24) TEXT

25) TEXT HOLD

26) DISPLAY

27) TEXT ZOOM/DVD ZOOM

28) DVD Menu/Record:

- To restart the current chapter

- To advance forward to the next chapter

- To stop/eject Disc (hold for 4 seconds to eject disc)

- To play in fast rewind mode

- To play in fast forward mode

- To play/pause

29) REC LIST

30) GOTO

31) A-B

32) REPEAT

33) ANGLE/ 3D - Change to 3D mode

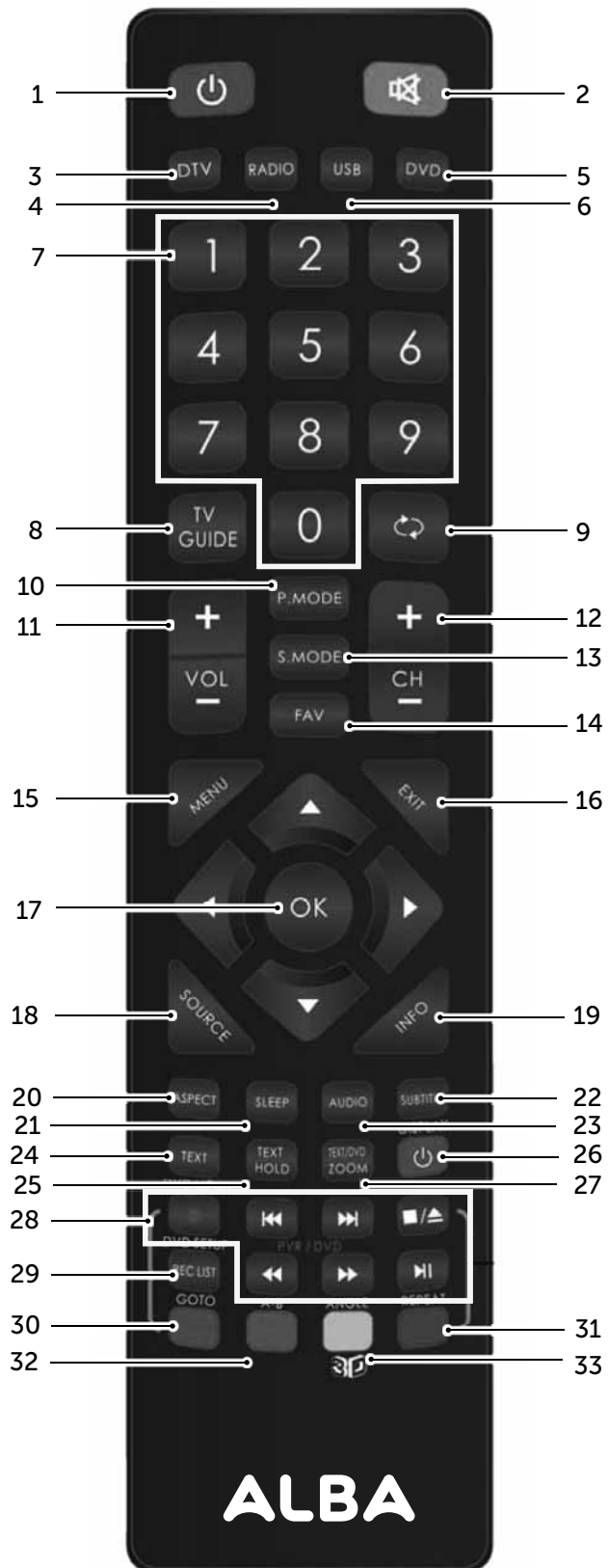

If you still require further assistance, call one of our experts on 0345 604 0105. (Calls are charged at the standard rate of your network provider).





# Connections 3

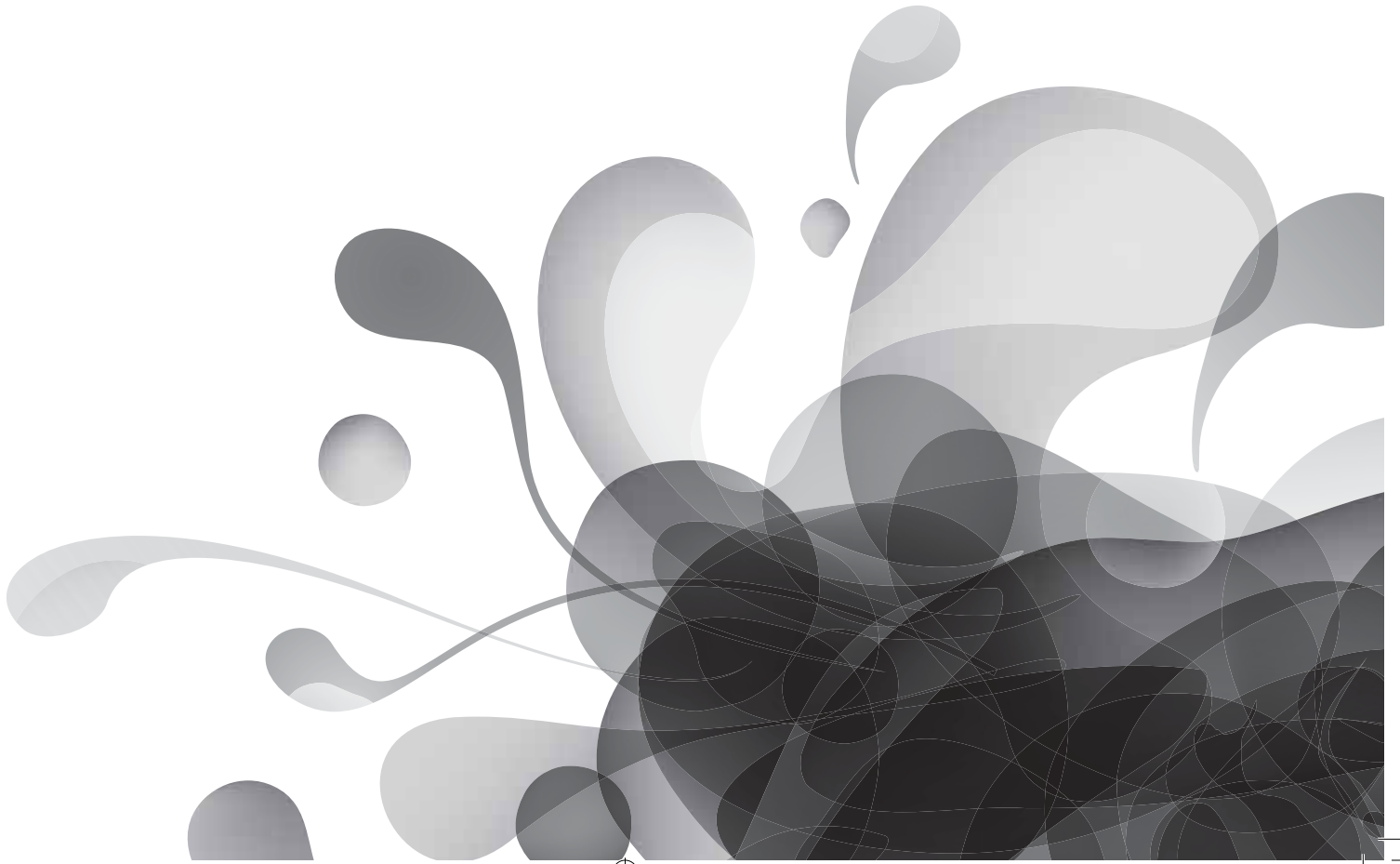

# Connections

Bringing it all together

## Connections

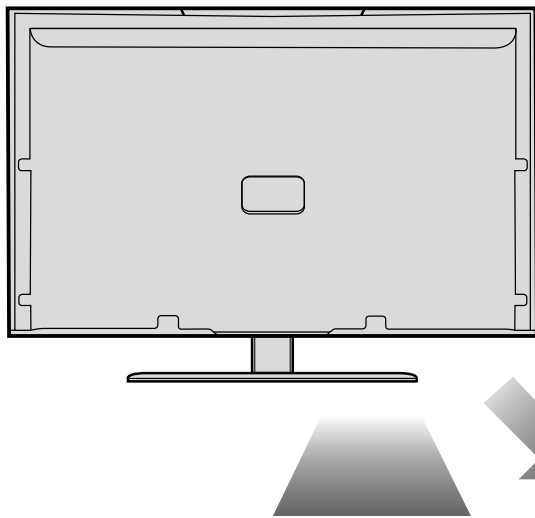

- |    |                   |                         |
|----|-------------------|-------------------------|
| 1  | ETHERNET/LAN      | Network connection      |
| 2  | COMPONENT (HD)    | Component input (YPbPr) |
| 3  | AV IN             | Audio Video input       |
| 4  | SCART             | SCART input             |
| 5  | HDMI 1 (ARC)      | HDMI input              |
| 6  | HDMI 2            | HDMI input              |
| 7  | RF IN             | RF / TV aerial input    |
| 8  | Optical audio out | Digital audio output    |
| 9  | USB 2.0           | USB input               |
| 10 | CI CARD IN        | Common Interface module |
| 11 | EARPHONE          | Earphone socket         |

\*The Ethernet port is used only for Freeview HD services only.

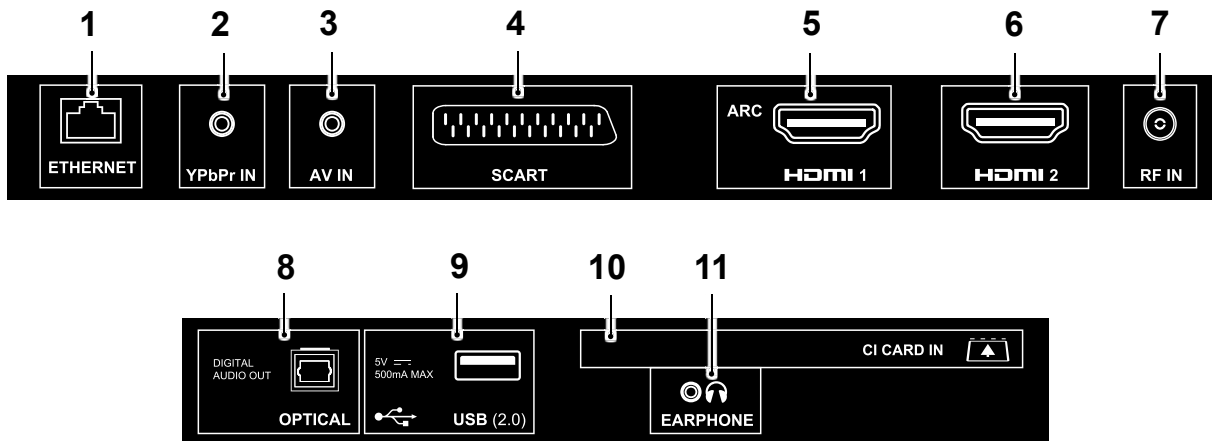

If you require any technical guidance or find that your TV is not operating as intended, a simple solution can often be found in the **Troubleshooting** section of these instructions.

# Connections

Bringing it all together

## Connections

Connecting a camcorder, camera or games console.

The TV source should be set to composite/AV.

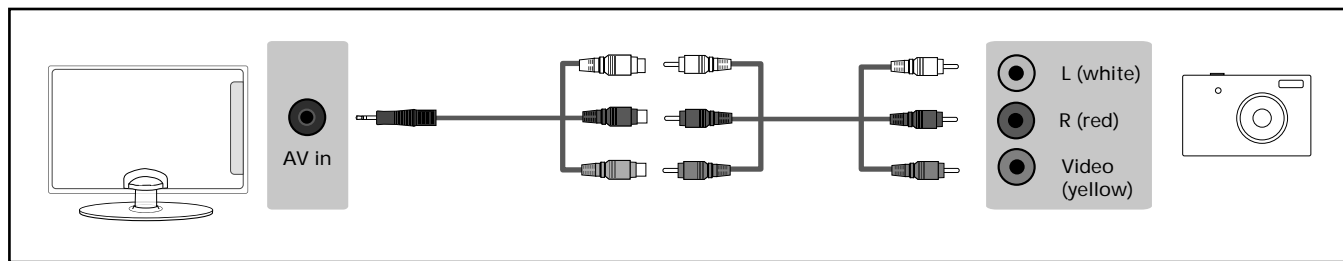

Connecting a DVD player/recorder, video recorder or cable/satellite box.

Source should be set to SCART..

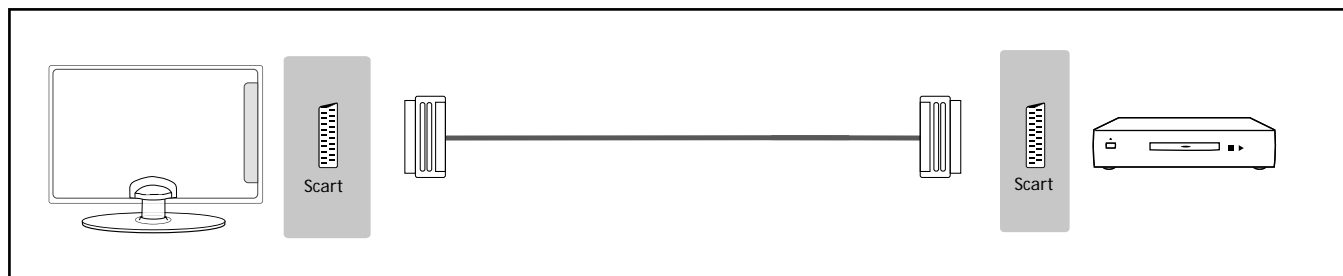

Connecting a High Definition (HD) Device Option 1 - via HDMI to HDMI cable

A HDMI cable can output both video and audio and enables you to enjoy digital-quality video and audio with minimal loss of quality.

TVs Source should be set to the corresponding HDMI Port (HDMI 1, HDMI 2, etc).

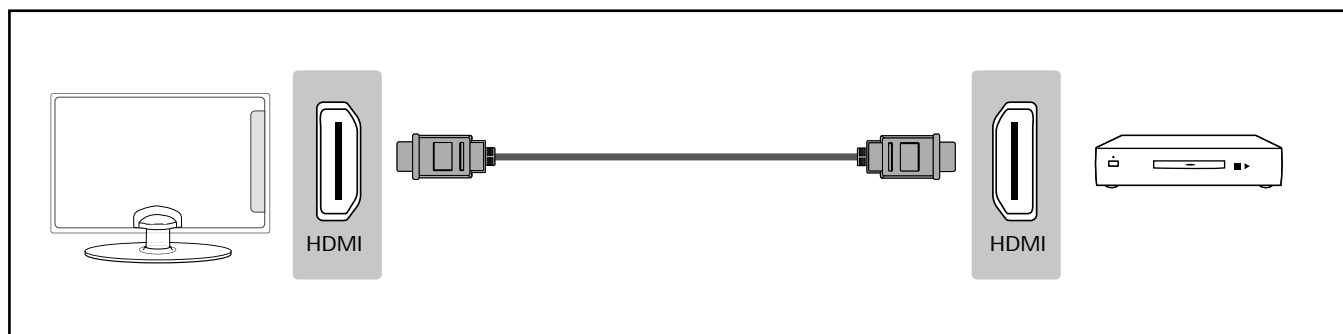

If you still require further assistance, call one of our experts on **0345 604 0105**. (Calls are charged at the standard rate of your network provider).

# Connections

Bringing it all together

## Connections

Connecting a High Definition (HD) Device Option 2 - via Component cable

If you are supplied with a cable from the device which has RED, GREEN, BLUE, RED & WHITE connectors you must connect via Component (for picture) and by phono cable (for sound).

TV Source should be set to Component/YPbPr.

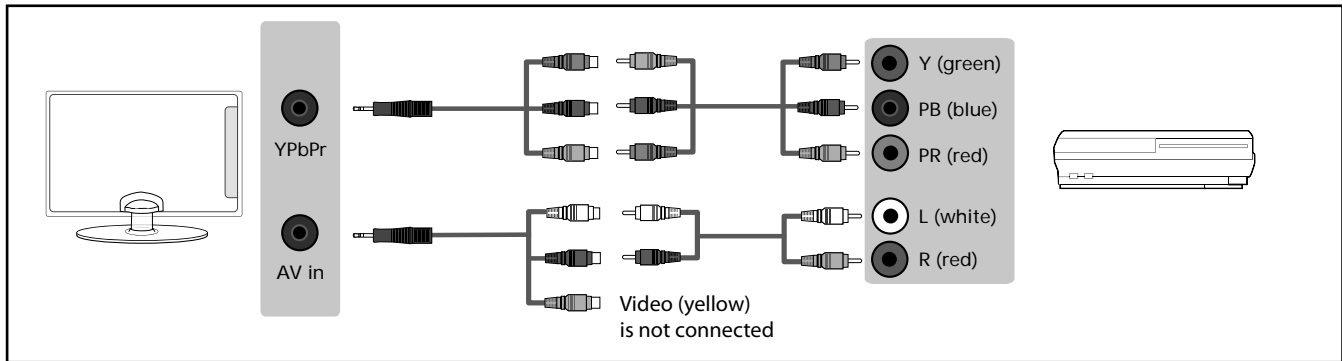

Connecting to an external audio device (Amplifiers, Surround Sound, Sound Bars etc)

When connecting via the TV's 3.5mm Earphone output, this will disable the TV speakers.

There are two options when connecting a device via the 3.5mm Earphone Output.

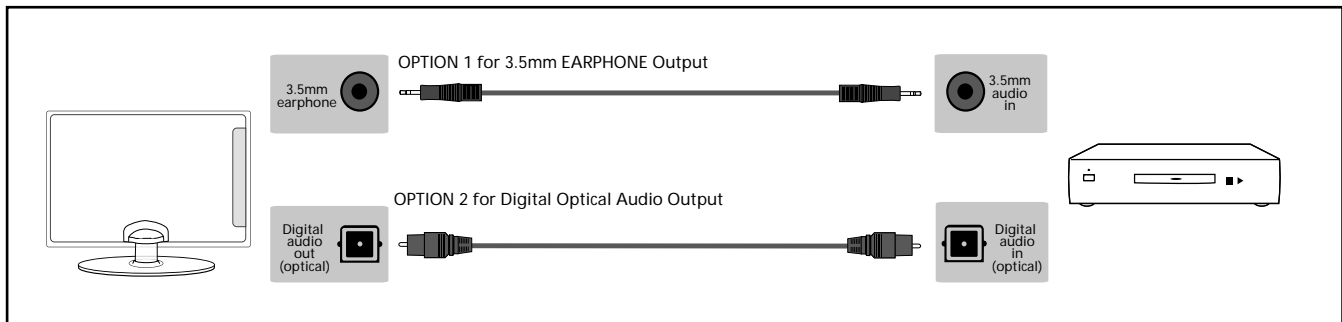

If you require any technical guidance or find that your TV is not operating as intended, a simple solution can often be found in the **Troubleshooting** section of these instructions.









# Standard features

# 4

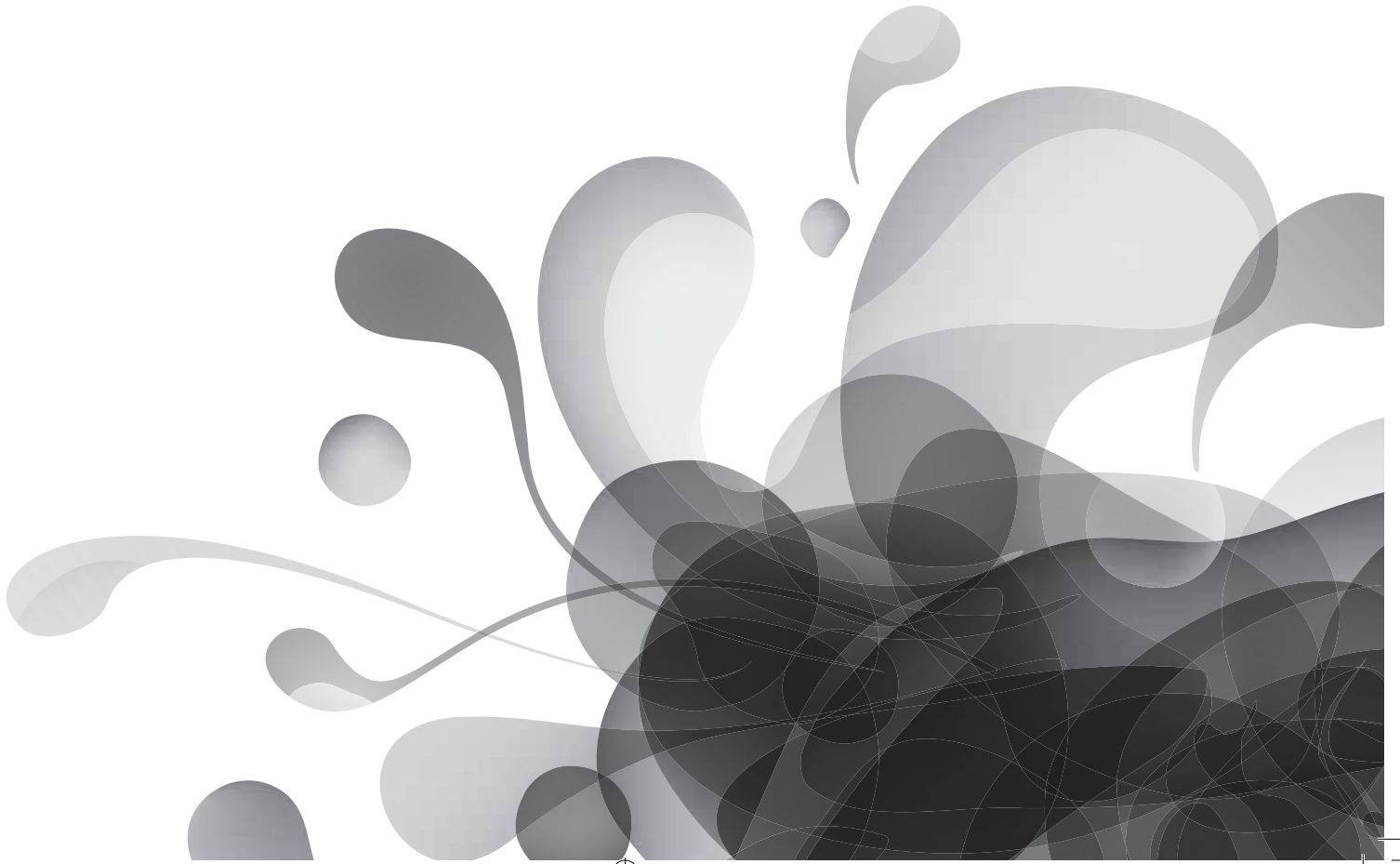

## Standard features

Simple everyday use

### How to navigate the menus

To access this menu, press [MENU] button on the remote control. To enter a menu press [OK]

If you wish to make changes to any of the default settings, use the scroll ▲▼▶◀ buttons. To confirm any settings press [OK] button.

To exit this menu at anytime, press [EXIT] button.



---

**Tip:** If you do not press any buttons for 30 seconds, the menu will automatically exit. You can change the length of time before the menu exits automatically - see 'OSD Timer' in the Time Menu.

---

If you require any technical guidance or find that your TV is not operating as intended, a simple solution can often be found in the **Troubleshooting** section of these instructions.

# Standard features

Simple everyday use

## Picture menu

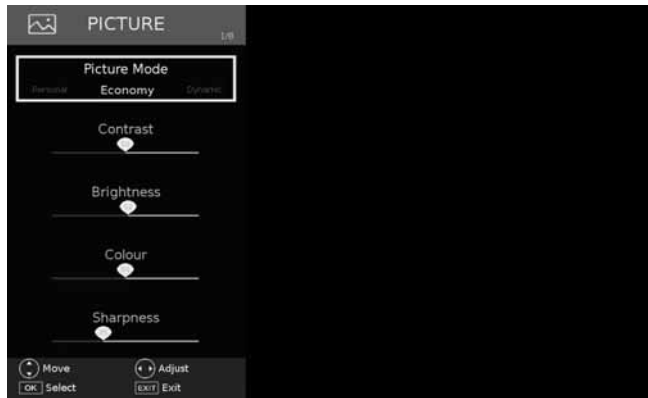

### Picture Mode

- **Dynamic** - Recommended settings for fast moving pictures.
- **Standard** - Default settings.
- **Movie** - Set to be lighter in colour and less bright.
- **Personal** - Lets you manually alter all the settings.
- **Economy** - Power saving mode which reduces the energy used by up to 25% (by reducing the power to the LED/LCD panel). In Economy mode, the TV will switch itself to Standby mode after 3-5 hours in the event that the TV buttons or remote control buttons are not pressed (change the picture mode to another setting to de-activate this function).

**Contrast** - Switch the balance between black and white.

**Brightness** - Increase or decrease the brightness of the picture.

**Colour** - Increases the colour from black and white.

**Tint** - Lets you increase or decrease the level of tint within the picture (only available in VGA/PC source mode).

**Sharpness** - Increase or decrease the sharpness of the picture.

### Colour Temperature

- **Normal** - Default settings.
- **Warm** - Increases red within the picture.
- **Cool** - Increases blue within the picture.

**Aspect Ratio** - Within the UK the picture format varies depending on the channel/broadcast. There are a number of different options to best meet your needs.

- **Auto** - Automatically displays the best picture format. So the picture is in the correct position. May have black lines at the top/bottom and/or sides.
- **Original** - Will display the picture from the broadcaster without any change
- **4:3** - Displays the 4:3 picture in its original size. Side bars are shown to fill the 16:9 screen.

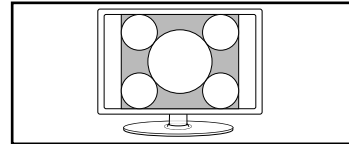

- **16:9** - Fills the screen with a regular 16:9 signal and 4:3 will stretch to fill the screen.

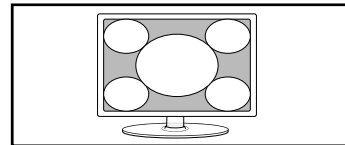

- **Zoom** - The picture is the correct proportion but zoomed in to fill the screen.

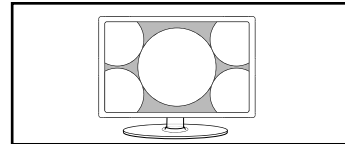

**Expert settings** - additional settings.

**Noise Reduction** - switch noise reduction ON/OFF.

**Active Contrast** - Automatically optimises the 'backlight' and 'contrast' of the picture according to the brightness of the screen. Choose one of the following presets: low, middle, high and Off.

If you still require further assistance, call one of our experts on 0345 604 0105. (Calls are charged at the standard rate of your network provider).

# Standard features

Simple everyday use

## Sound menu

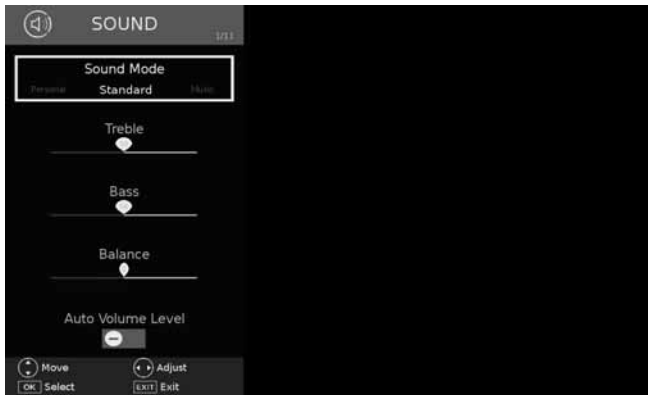

### Sound Mode

- **Standard** - Default settings.
- **Music** - Emphasises music over voices.
- **Movie** - Provides live and full sound for movies.
- **Sports** - Emphasises sound for sports.
- **Personal** - Selects your personal sound settings.

**Treble** - To adjust the amount of high frequency within the sound.

**Balance** - To switch the sound between the left and right speakers.

**Auto Volume Level (AVL)** - When 'on' is selected, the volume will stay at a constant level regardless of input/source.

### DTS TruSurround Sound

- **OFF** - Off.
- **ON** - TruSurround HD™ creates an immersive, feature-rich surround sound experience from two speakers, complete with rich bass, high frequency detail and clear dialog.

### Digital Output

- **Off** - Off.
- **Auto** - Selects the best settings automatically.
- **PCM** - Select this option if you are connecting to a Stereo Hi-fi via coax cable (Pulse-code modulation (PCM) is a digital representation of an analogue signal).

**Audio Description** - This allows the user to increase and decrease the AD (Audio Description) volume level. (Audio Description is a service available on certain programmes. It provides a description of what is happening during the selected programme for a person who is visually impaired).

**AD Volume** - This allows the user to increase and decrease the AD (Audio Description) volume level.

**Audio Delay (ms)** - Enables the user to adjust setting to sync picture and audio.

**SPDIF Delay** - Enables the user to adjust sound setting to sync picture and audio for external speakers connected via digital audio output.

---

Tip: Treble and bass levels can only be adjusted when the sound mode 'personal' is selected.

---



For DTS patents, see <http://patents.dts.com>. Manufactured under license from DTS Licensing Limited. DTS, the Symbol, & DTS and the Symbol together are registered trademarks, and DTS TruSurround is a trademark of DTS, Inc. © DTS, Inc. All Rights Reserved.

If you require any technical guidance or find that your TV is not operating as intended, a simple solution can often be found in the **Troubleshooting** section of these instructions.

# Standard features

Simple everyday use

## Channel menu

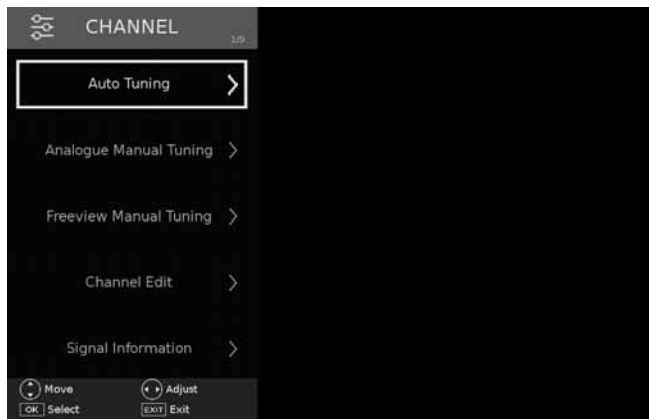

**Auto Tuning** - Allows you to retune the television for all digital channels, digital radio stations and analogue channels.

**Analogue Manual Tuning** - Allows you to manually tune your analogue signal.

**Freeview Manual Tuning** - Allows you to manually tune your digital signal.

**Channel Edit** - Allows you to delete, move, skip and add favourite channels.

**Signal Information** - Displays signal strength information.

**CI Information** - Pay per view services require a "smartcard" to be inserted into the TV. If you subscribe to a pay per view service the provider will issue you with a 'CAM' and a "smartcard". The CAM can then be inserted into the COMMON INTERFACE PORT (CI Card In).

**Record list** - Lists your recorded programmes.

**Schedule List** - Lists your programme reminders.

**OAD** - Switch on/off OAD (over air download) software updates.

**Tip:** If you do not press any buttons for 30 seconds, the menu will automatically exit. You can change the length of time before the menu exits automatically - see 'OSD Timer' in the Time Menu.

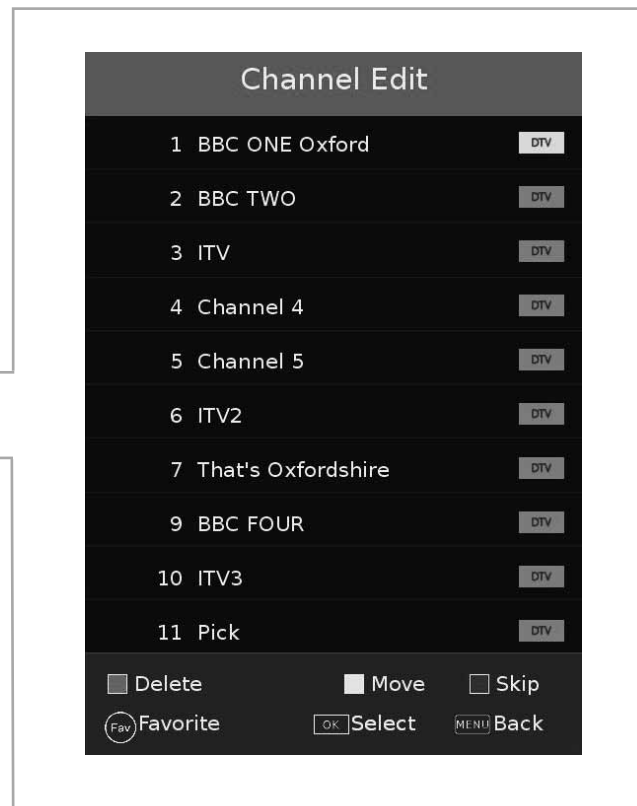

If you still require further assistance, call one of our experts on 0345 604 0105. (Calls are charged at the standard rate of your network provider).

# Standard features

Simple everyday use

## Time menu

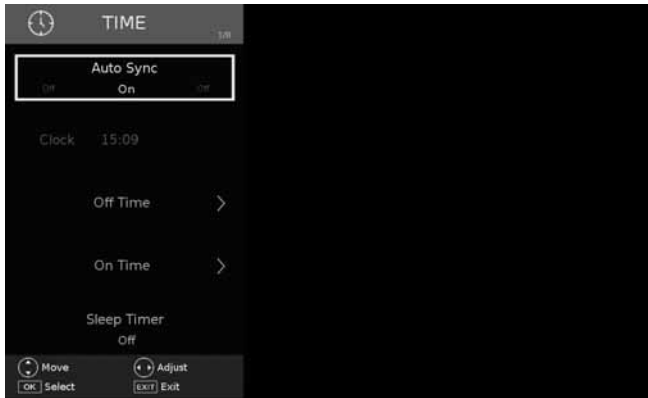

**Auto Sync** - ON/OFF - Automatically sets date and time.

**Clock** - Shows the date and time.

**Off Time** - Allows you to set a specific time for your TV to turn off.

**On Time** - Allows you to set a specific time for your TV to turn on, the channel it will then display, the source it will be on and also the volume. This function can then be toggled to repeat every day or a certain day.

**Sleep Timer** - Lets you set the sleep timer so the television automatically switches off after a set amount of time. Off -> 10min -> 20min -> 30min -> 60min -> 90min -> 120min -> 180min -> 240min.

**OSD Timer** - Lets you adjust the amount of time the On Screen Menu stays on the screen before disappearing.

**Auto standby** - Set Auto standby between 3 hours, 4 hours and 5 hours ( to turn off this function you must exit Home Mode in the Picture Menu).

**Time Zone** - Change your current time zone.

## System/Hotel lock menu

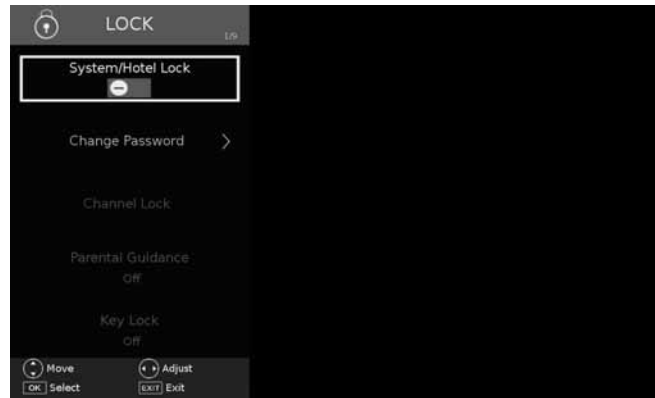

**System/Hotel Lock** - Allows you to lock or unlock the menu. You will be asked to enter a 4 digit password use the ◀ button to quit the password input. Use the ▶ button to clear. Default password is 0000.

**Change Password** - Allows you to change the password.

**Channel Lock** - Allows you to lock certain channels manually.

**Parental Guidance** - Allows you to set the rating to block certain content based on age information.

**Key Lock** - Allows you to lock the buttons on the side of the TV set.

**Default Source** - Allows the user to set the default source. The default source is the source the TV starts on when first switched on.

**Default Channel** - Allows the user to set a channel as the default channel on the Digital source. The default channel is the channel the TV starts on when first switched on.

**Max Volume** - Allows you to adjust and set the maximum volume.

**Source Lock** - Allows you to lock the source menu.

If you require any technical guidance or find that your TV is not operating as intended, a simple solution can often be found in the **Troubleshooting** section of these instructions.



# Standard features

Simple everyday use

## Settings menu

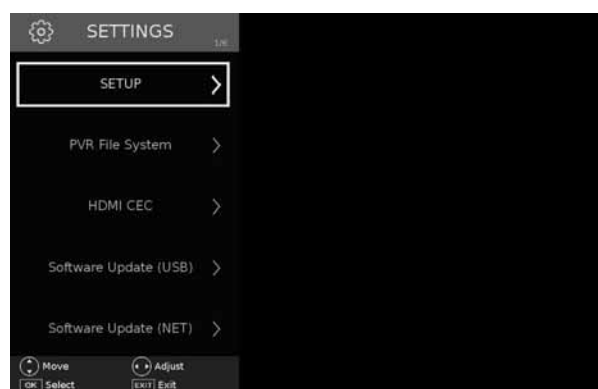

**SETUP menu** - select from the following options:

**Language** - Allows you to change the language of the menu.

**Audio language 1** - Select your preferred primary audio language.

**Audio language 2** - Select your preferred secondary audio language.

**Subtitle Language 1** - Select your preferred primary subtitle language

**Subtitle Language 2** - Select your preferred secondary subtitle language

**Hearing Impaired** - This allows the user to turn on the Hearing Impaired function, this produces subtitles on the screen which provide a description of what is happening during the selected program..

**Blue Screen** - Changes the background when there is no input between clear and a blue background (Only available on some sources).

**LED Status** - Allows the user to switch the LED Power indicator light ON or OFF, when the TV is being operated.(When this option is set to OFF the LED Power indicator light will flash when the remote control is used).

**First Time Installation** - Allows you to retune the television for all digital channels, digital radio stations and analogue channels.

**Reset TV** - This resets the menus to factory settings and will erase all TV channels stored on the television.

**NETWORK menu** - select from the following options:

**IP config** - Allows you to access LAN network connection settings. Choose from the following options:

**Auto:** Will automatically connect the TV to your home network (this is the default setting and is highly recommended).

**Manual:** Allows you to manually change the IP, Netmask, Gateway and DNS information.

**Network info** - Allows you to view Information about network settings.

**Network test** - Allows you to test the network connection.

**PVR File System** - Allows you to view the format and performance of a USB key.

**HDMI CEC (Consumer Electronic Control)** - Allows HDMI devices to control each other and allows the user to operate multiple devices with one remote control. (only available with compatible devices).

**Software Update (USB)** - This menu lets you install the new software/firmware onto the television. Further details of how to do this will be issued with the firmware. Contact the helpline or refer to the 'product support' section of the website.

**Software Update (NET)** - Allows you to update your TV with the newest software via your internet connection.

**Version Info** - Allows you to view the version/ information of the software installed on the TV set.

If you still require further assistance, call one of our experts on 0345 604 0105. (Calls are charged at the standard rate of your network provider).





# Advanced features 5

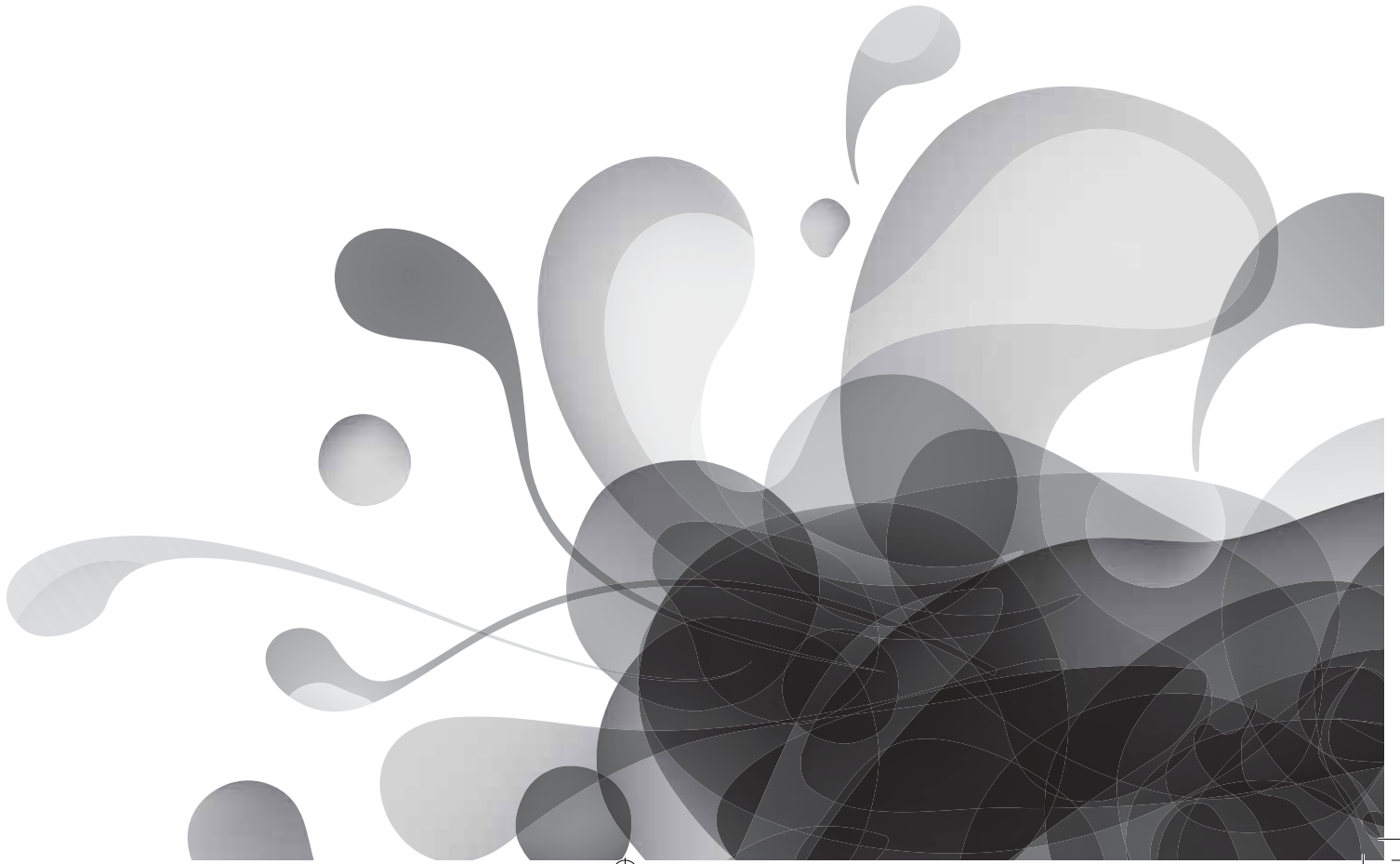

# Advanced features

## Getting the most from your TV

### 7 day TV guide and channel list

TV Guide is available in Digital TV mode. It provides information about forthcoming programmes (where supported by the freeview channel). You can view the start and end time of all programmes and on all channels for the next 7 days and set reminders.

1) Press [TV GUIDE]. The following 7 Day TV Guide will appear.

04:55 PM  
Thu 17/ 8/2017

### 3 ITV

**Tipping Point**  
04:00 PM - 05:00 PM Thu 17/08/2017  
Entertainment

## PROGRAMME GUIDE

	Now	5:00PM	5:30PM	6:00PM	6:30PM	7:00PM	
1	BBC ONE O...	Flog It!	Pointless	BBC News at ...	BBC Oxford ...	The One Show	
2	BBC TWO	Quo Vadis	Put Your Money Wher...	Eggheads	Royal Recipes	Celebrity ...	
3	ITV	Tipping Point	New: Cash Trapped	ITV News ...	ITV Evening ...	Emmerdale	
4	Channel 4	A Place in the...	Four in a Bed	Come Dine wi...	The Simpsons	Hollyoaks	Channel 4 News
5	Channel 5	After All Thes...	5 News At 5	Neighbours	Home and ...	5 News Tonight	All New Traffi...
6	ITV2	The Jeremy ...	Judge Rinder	You've Been Framed! Reloaded	You've Been ...		
7	That's Oxfo...	Talking Pictures TV		Oxfordshire Headline News	Oxfordshire ...		
9	BBC FOUR	This Is BBC Four				World News ...	

INFO Info    Freeview    Record    Remind    Prev Day    Next Day

2) Navigate through the menu using ▲▼▶◀

You can now:

Record a programme by pressing **RED**

View a previous day by pressing **GREEN**

View the next day by pressing **YELLOW**

Set a reminder by pressing **BLUE**

3) Press [EXIT] to exit the 7 day TV Guide.

If you require any technical guidance or find that your TV is not operating as intended, a simple solution can often be found in the **Troubleshooting** section of these instructions.

# Advanced features

## Getting the most from your TV

### USB media player

USB mode offers playback of various different types of content that you have saved on your USB Memory Stick.

On switching to USB source the menu screen will appear. The content will be divided into Photo, Music, Movie and Text based on file type.

- 1) You can navigate through the menus using the scroll ▲▼▶◀ buttons. To confirm the item you wish to play/view press [OK] button.
- 2) Select the drive you require. (If your drive only has 1 partition you will only see 1 item).
- 3) You can now access the item. Press OK to view.
- 4) While viewing you control the item using (Fig A). or by pressing ( i ) and using ▲▼▶◀ and (OK).

**Tip:** If you experience a playback issue, please ensure the files being used are the correct format (example - the picture plays but no sound)

**For the best performance, do not use USB extension cable. See technical specification page for compatible file types.**

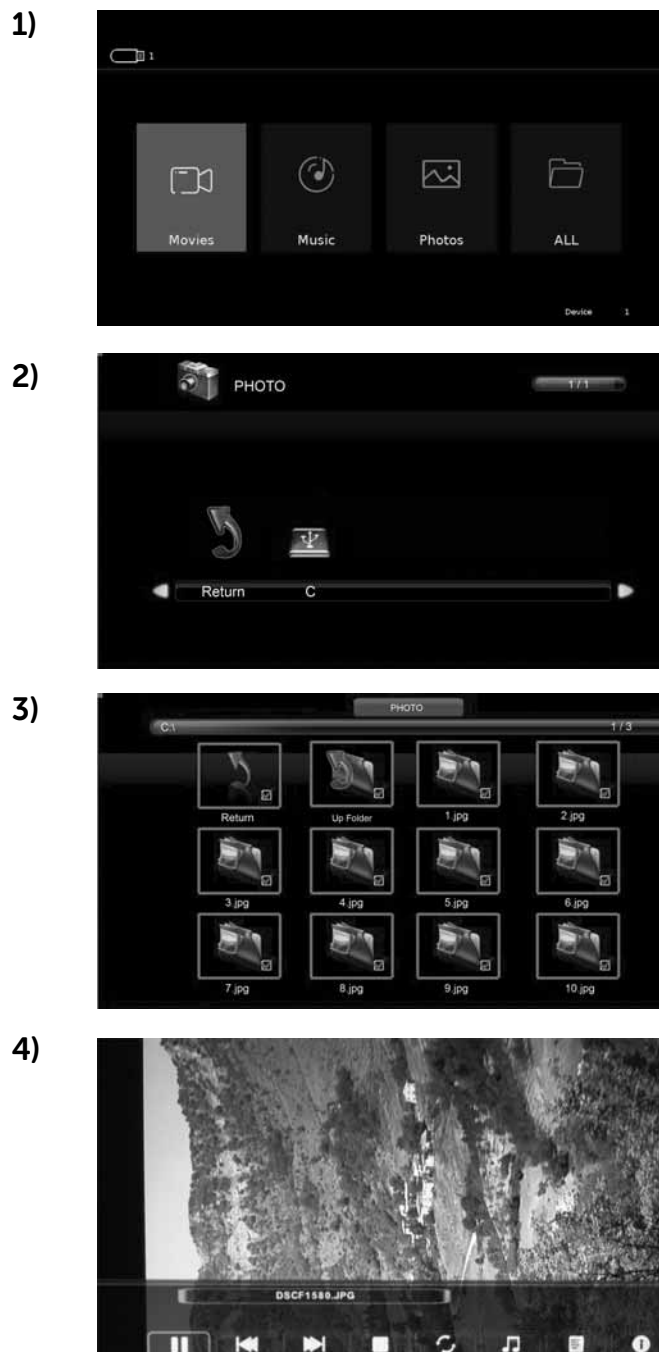

If you still require further assistance, call one of our experts on 0345 604 0105. (Calls are charged at the standard rate of your network provider).

# Advanced features

## Getting the most from your TV

### USB record - Freeview/Soarview mode

#### USB record – Freeview/Saorview mode

Built into this television is a USB record facility. This function is available in Freeview/Soarview mode when used in conjunction with a compatible USB memory stick or USB hard drive. The benefits of this are as follows:

- Pause live TV and then playback, fast forward and rewind (up to live TV)
- One button record, if you decide you want to record the current programme
- Easy programmable recording from the 7 day TV Guide

Due to the nature of the product, it is necessary to use a high speed USB memory stick (as the TV reads from and writes to the memory stick at the same time, some memory sticks may not be suitable). You can purchase high speed memory sticks from some computer stores, alternatively, we have a selection of tested and compatible memory sticks available to purchase directly from the helpline/web site.

#### Recommended Minimum Specification - USB Memory Stick

Read Speed: 20 Mb/s (MegaBit Per Second)

Write Speed: 6 Mb/s (MegaBit Per Second)

If you wish to use a USB portable hard drive larger than 32GB, please refer to the FAQ section at the rear of this user guide.

### Pause Live TV (Time Shift)

Pausing Live TV is very simple.



⏸ - Press the play/pause button and the television will pause and the live content will be recorded. To resume watching press play/pause again.

⏩ - Press fast forward to go forward in a recording (i.e. to skip adverts).

⏪ - Press fast rewind to go back in a recording (i.e. if you fast forwarded too far).

If you require any technical guidance or find that your TV is not operating as intended, a simple solution can often be found in the **Troubleshooting** section of these instructions.

# Advanced features

## Getting the most from your TV

---

**Tip:** When you switch the TV to standby or change channel the Time Shift memory is wiped. To restart time shift you must press play/pause button.

---

### One Button Record

At any point in time you may decide to record the current programme that you are watching. To do this you need to press the red button highlighted below.

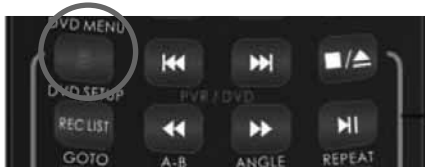

### Playback files from Record list

To playback recorded files you will be required to have the TV set to the Freeview/Saorview source mode. Once set to the correct source, access the recorded list by pressing the REC LIST (Recorded List) button on the remote control, the recorded list should now appear on the screen, press OK on the chosen file to start.

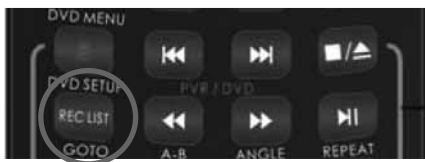

---

**Tip:** This television contains one TV tuner, therefore it can only record the channel you are watching or record one channel while the television is in standby mode.

Note: USB record function is only available in Digital/Freeview TV mode. Due to copyright laws and illegal copying/recording it is not possible to record to/from any other input/output source.

---

If you still require further assistance, call one of our experts on 0345 604 0105. (Calls are charged at the standard rate of your network provider).

# Advanced features

## Getting the most from your TV

### DVD setup

**TV Display** - Choose from the following options

4:3 Pan Scan	PS Traditional picture format, often used on old film
4:3 Letter Box	LB Traditional picture which has been adapted for widescreen
Wide	16:9 Widescreen picture format

**Speaker Setup** - Choose from the following options

LT/RT	Converts from multi-channel sound to mono
Stereo	Converts from multi-channel sound to Stereo

**Dual Mono** - Choose from the following options

Stereo	Outputs 2 channels of sound both left and right
Mono L	Outputs left side sound
Mono R	Outputs right side sound
Mix Mono	Outputs a single channel of sound but mix between right and left

**Dynamic Range** - This is the difference between the quietest and loudest sounds. This setting works only with DVD discs recorded in Dolby digital.

Full	Set this to listen with the range recorded on the disc
3/4	Set this to listen with a range equivalent to a normal television
1/2	Set this to listen with a smaller difference between the maximum and minimum volume
1/4	Set this to listen with a smaller difference between the maximum and minimum volume
Off	Set dynamic range to off

**TV Type** - Choose from the following options

PAL	For discs from UK/Europe, Asia, Australia etc
Multi	For both NTSC and PAL
NTSC	For discs from North America, Japan etc

**Default** - Choose from the following options

Reset	Resets all options in the 'DVD setup' menu back to the default settings
-------	---

**Tip:** This TV/DVD player is pre-set to play Region 2 DVDs. In the event you wish to use the TV/DVD in another country that uses different region discs, please visit [www.umc-uk.co.uk](http://www.umc-uk.co.uk). Select 'Product Support', 'Changing Region'.

If you require any technical guidance or find that your TV is not operating as intended, a simple solution can often be found in the **Troubleshooting** section of these instructions.









Product support

6

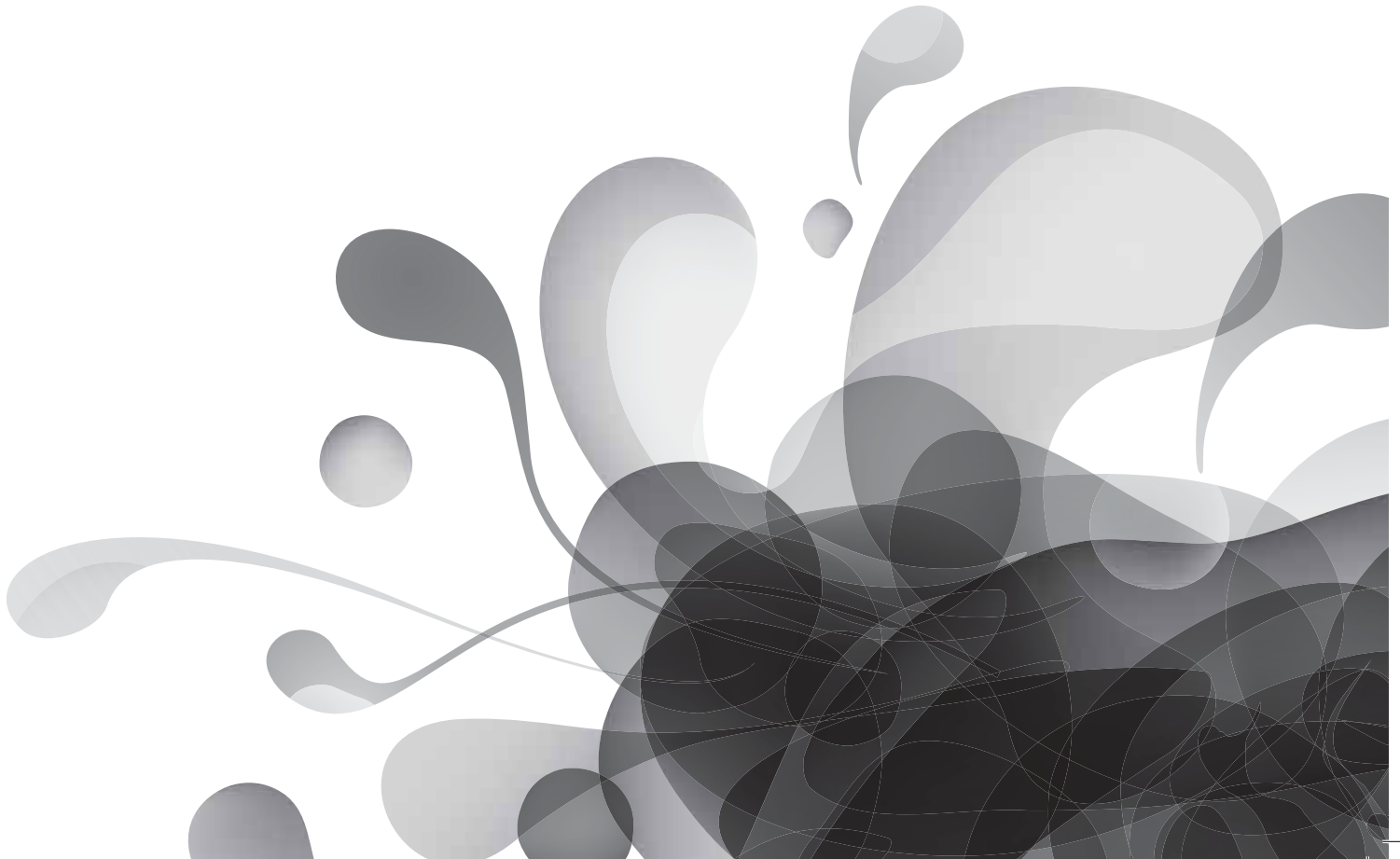

# Product support

Help is always at hand

## Connecting a sky digital set top box

### Using a Sky Remote or a Universal Remote to operate your TV

Sky Remote Control - If you wish to use your Sky remote to operate the basic functions of your TV, you need to program a 4 digit code into it. Please note - you will need a Sky Revision 9 remote control (or later). If you wish to upgrade/replace your existing Sky remote control to the latest version, you can do so on our website.

Universal Remote Control - If you wish to use a Universal remote control to operate your TV, please refer to the website for a full list of codes. (Please note we only have codes for One for All branded remote controls, if you have an alternative brand of Universal remote, please refer to the manufacturer for the code).

### Connecting your TV to your Sky box (when both the TV and Sky Box are located in the same room)

#### Option 1)

Depending on your Sky Box & TV model, connect either by SCART or HDMI cables (available separately).

If connecting by SCART, select the 'Input source' on the TV as SCART. If your TV model does not have SCART, please refer to the 'Connections' pages in this user guide for alternative ways to connect.

If connecting by HDMI, select the 'Input source' on the TV as HDMI (if the TV has more than 1 HDMI port, ensure you select the input source to match the HDMI numbered port on the rear of the TV).

If you wish to use your Sky remote to operate the TV's functions, you will need a Sky remote control (Revision 9 or later) and you will need to program a 4 digit code into it.

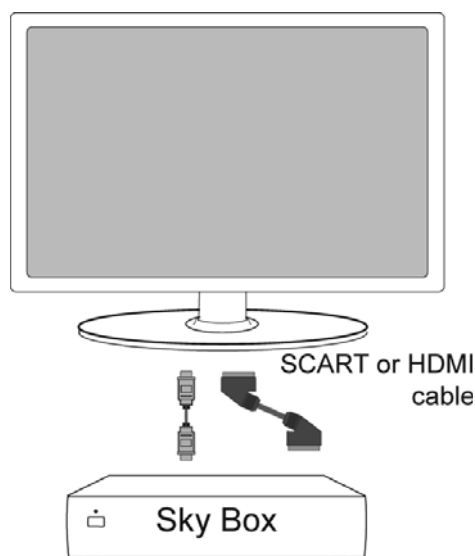

If you require any technical guidance or find that your TV is not operating as intended, a simple solution can often be found in the **Troubleshooting** section of these instructions.

# Product support

Help is always at hand

## Connecting your TV to your Sky box (when your Sky box is located in a different room to the TV)

### Option 2)

Please note, if you are adding a 'Magic Eye/TV Link' to your system so that you can use your Sky remote control to change the Sky channel in the room where the 2nd TV is located, please refer to the instructions included with the TV link/magic eye in order to ensure the RF or RF2 output on your Sky box is powered on. (The red LED light on the TV link/magic eye will light up if the RF/RF2 output is correctly set up) If you do not have the instructions that came with the TV link/magic eye, instructions on how to do it can be found on our website.

- 1)** To tune the TV to the Sky box, on the 2nd TV, select the 'Analogue' input source.
- 2)** Select the channel that you wish to store the Sky box/channel on. (If you do not use channels 1-5 because you no longer have analogue terrestrial channels after digital switchover, you may choose to select channel 1 to store the Sky box/channel, if you still have and use analogue channels 1-5, you may for example decide that channel 6 is the best option for you)
- 3)** Press the corresponding number on the remote control to select the desired analogue channel chosen as per point 2 above.
- 4)** On the TV remote control, press Menu. Now navigate through the menus to select Manual Tuning or Analogue Manual Tuning (refer to the Tuning/Channel menu section of this user guide if necessary)
- 5)** Manually tune in the channel (usually, the Sky box is at a frequency between 800Mhz and 850Mhz) once the Sky box/channel is found, press 'OK' to store it. If you wish to use your Sky remote to operate the TV's functions, you will need a Sky remote control (Revision 9 or later) and you will need to programme a 4 digit code into it.

If you wish to use your Sky remote to operate the TV's functions, you will need a Sky remote control (Revision 9 or later) and you will need to programme a 4 digit code into it.

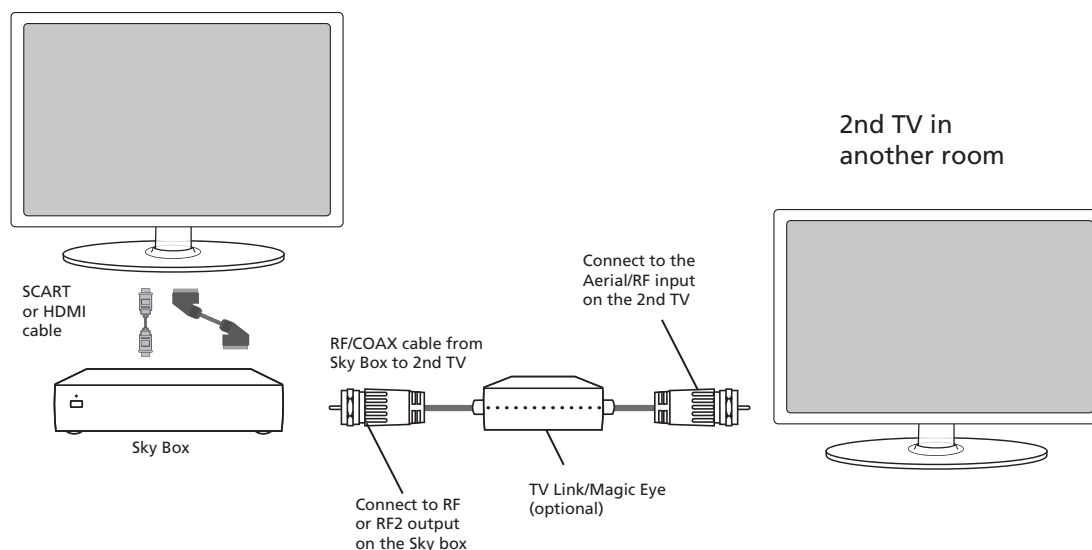

If you still require further assistance, call one of our experts on **0345 604 0105**. (Calls are charged at the standard rate of your network provider).

# Product support

Help is always at hand

## Frequently asked questions

General	I would like to have louder sound by connecting additional speakers.	1) Use the 3.5mm headphone output and a 3.5mm to phono cable (available separately) to connect to an amplifier/surround sound system. Please note this will deactivate the TV's built in speakers. 2) Connect a COAX cable from the TV's COAX output to your amplifier/surround systems COAX input.
General	Why are some options in the menu unavailable and greyed out.	Some options are only available in certain sources, i.e. HDMI. They are unavailable in the other sources where they have no affect.
General	Can I stop my TV automatically turning off after 4hrs?	Yes, in the 'Time' menu settings, scroll down to Auto standby and select OFF.
TV	I have tuned in Digital TV but I am not receiving any or all of the channels and/or the channels I receive are breaking up.	1) Check you are in an area that can receive Freeview/Saorview, visit <a href="http://www.freeview.co.uk">www.freeview.co.uk</a> or <a href="http://www.saorview.ie">www.saorview.ie</a> 2) Check you are using an aerial that is able to receive a good digital signal. In most cases, you will need an outdoor digital hi-gain/wideband aerial. In areas that have excellent digital coverage, you may be able to use a loft type aerial but it is highly likely that you will also need to connect a booster between the back of the TV and the TV aerial wall socket. Unfortunately, to receive a good enough digital signal, it is not possible to use a portable/indoor type aerial.
TV	I have re-tuned my television but when I switch it off it is not storing the channels.	If the TV does not save the channels when you power it off, it's likely the channel database has become corrupt. 1) Turn off the TV. 2) Remove the RF/Aerial cable from the rear of the TV and then turn the TV back on again. 3) Using the remote control, press Menu followed by 8-8-8-8 to enter the initial setup/first time installation menu. 4) Press OK (let the TV run the full tuning process). 5) Once completed, turn off the TV, reconnect the RF/Aerial cable then turn the TV back on again. 6) Repeat steps 3 & 4.
VCR/DVD Recorder	I have connected the TV to my VCR or DVD Recorder via SCART but it is not recording.	In addition to connecting via SCART, you should connect the aerial cable from the wall socket to your VCR/DVD Recorder and another aerial cable from the VCR/DVD Recorder to the TV.
Game Consoles	I have connected my Playstation/Xbox to the TV via HDMI, but I am not receiving any pictures or sound on my Television.	1) Ensure the TVs' source is set to HDMI. 2) Check your settings on your Playstation/Xbox are as per the Playstation/Xbox instruction manual.

If you require any technical guidance or find that your TV is not operating as intended, a simple solution can often be found in the **Troubleshooting** section of these instructions.

# Product support

Help is always at hand

## Frequently asked questions

Game Consoles	I have connected my Playstation/Xbox to the TV via Component cables (red, green & blue) but I am not receiving any sound.	Component cables only provide HD pictures. For the sound you will need to connect the red & white audio cables on the Playstation/Xbox to the red & white phono inputs (or mini AV input where fitted) on the rear of the TV. Please refer to the 'Connections' pages.
System Lock	I have changed the password on the television and now forgotten it.	There is a master password of 4711, to gain access to the TV menu and reset the normal password.
USB Mode	I have inserted a USB Memory Key, but the TV does not recognise it.	Ensure the USB Memory Key is formatted to type FAT32.
USB Mode	Using a USB portable hard drive / larger than 32GB.	If you wish to use a portable hard drive larger than 32GB, please note that it must be formatted to the FAT32 file system in order to operate on this TV. Windows XP/Vista computers are only capable of formatting up to 32GB, therefore, you will need a software programme/utility to format larger hard drives. Please refer to the website, <a href="http://www.umc-uk.co.uk">www.umc-uk.co.uk</a> , for more information.
DVD (For TV models with DVD only)	I have inserted a disc but it is not playing.	<ol style="list-style-type: none"><li>1) Ensure you have inserted the disc facing the correct way.</li><li>2) Ensure the disc is clean and is not scratched.</li><li>3) Some copied discs will not play.</li><li>4) Check the DVD is a region 2 disc – to change the region of the DVD player, refer to <a href="http://www.umc-uk.co.uk">www.umc-uk.co.uk</a>, select 'Changing DVD Region' in the 'Product Support' section</li></ol>
DVD (For TV models with DVD only)	I have pressed the eject button but the disc is not coming out.	To eject the disc hold the stop/eject button for 4 seconds.
USB Record (For TV models with USB record only)	I cannot change the channel, access the menu or use the red button.	During time shift you cannot change the channel, access the menu or use the red button.
USB Record (For TV models with USB record only)	When using the USB to record the picture 'breaks up' or experience loss of sound.	Check the USB memory stick meets the minimum read speed requirements. Standard definition channels require a read speed of 20 MB/s (Mega Byte per second) and a write Speed of 6 MB/s (Mega Byte per second) HD channels require the read speed of 80 MB/s (Mega Byte per second) and a write speed of 40 MB/s (Mega Byte per second). USB 3.0 sticks should be used where possible.

If you still require further assistance, call one of our experts on **0345 604 0105**. (Calls are charged at the standard rate of your network provider).

# Product support

Help is always at hand

## Technical specification

Product fiche

Trademark	Alba
Model ID	236/2070-GB-3B-EGDPS-UK 236/2070-GP-3P-EGDPS-UK 236/2070-GW-3W-EGDPS-UK
Energy efficiency class	A
Visible screen size (diagonal)	60 cm / 23.6 inches
On mode power consumption	25.0 W
Annual energy consumption *1	37 kWh
Standby power consumption *2	<0.50 W
Off mode power consumption	0 W
Screen resolution	1366 (H) x 768 (V)
*1: Energy consumption XYZ kWh per year, based on the power consumption of the television operating 4 hours per day for 365 days. The actual energy consumption will depend on how the television is used. *2: When the TV is turned off with the remote control/standby button and no function is active.	

Additional Technical Information	
RF	75 ohm Antenna / Analog / DVB
Video Inputs	2 x HDMI, 1 x SCART, 1 x USB, 1 x Mini Composite/Video, 1 x Mini Component/YpPr
Sound Inputs	1 x shared audio for Composite/Video & Component/YpPr
Sound Outputs	1 x 3.5mm headphone jack, 1 x Digital Optical Audio output
Speaker / Amplifier Watts (RMS)	2 x 5W / 2 x 3W
Dimensions including stand (mm)	560W x 386H x 140D
Net weight	4.3 kgs
Energy Consumption Info	
Voltage and power consumption	220-240V 50Hz 25 / 50W (ecomode/max) EEI - A (Energy Rating)
Wall mounting VESA	100 x 100 (mm)

If you require any technical guidance or find that your TV is not operating as intended, a simple solution can often be found in the **Troubleshooting** section of these instructions.



# Product support

Help is always at hand

## Technical specification

Compatible files in USB Mode

Media	File Ext.	Codec		Remark
		Video	Audio	
MOVIE	.mpg	MPEG-1, MPEG-2	MP3, AAC, AC3, PCM,	<b>Max Resolution:</b> 1920x1080 <b>Max Data Rate:</b> 40 Mbps
	.avi	Xvid, MJPEG		<b>Max Resolution:</b> 1920x1080 <b>Max Data Rate:</b> 20 Mbps
		MPEG-4 SP/ASP, H.263/H.264		
	.ts	MPEG-2, H.264, HEVC		
	.mov .mkv	MPEG-4 SP/ASP, H.263/H.264, HEVC		
	.dat	MPEG-1		
	.mp4	MPEG-4 SP/ASP, H.263/H.264, HEVC		
MPEG-1, MPEG-2				
.vob	MPEG-2	<b>Max Resolution:</b> 720x576 <b>Max Data Rate:</b> 40 Mbps		
MUSIC	.mp3	--	MP3	<b>Sample Rate:</b> 8K ~ 48KHz <b>Bit Rate:</b> 32K ~ 320Kbps
	.m4a/.aac	--	AAC	<b>Sample Rate:</b> 16K ~ 48KHz <b>Bit Rate:</b> 32K ~ 442Kbps <b>Channel:</b> Mono/Stereo
PHOTO	.jpg/	Progressive JPEG		<b>Max Resolution:</b> 1024x768
	.jpeg	Baseline JPEG		<b>Max Resolution:</b> 15360x8640
	.bmp	BMP		<b>Max Resolution:</b> 9600x6400 <b>Pixel Depth:</b> 1/4/8/16/24/32 bpp
		.png	Non-Interlaced	
Interlaced			<b>Max Resolution:</b> 1280x800	
SUBTITLE	.srt	SubRip		
	.ssa/.ass	SubStation Alpha		
	.smi	SAMI		
	.sub	SubViewer MicroDVD DVDSubtitleSystem SubIdx(VobSub)	SubViewer 1.0 & 2.0 Only	
		.txt	TMPlayer	

If you still require further assistance, call one of our experts on 0345 604 0105. (Calls are charged at the standard rate of your network provider).

## Product support

Help is always at hand

# ALBA

## Your Alba Guarantee

This product is guaranteed for twelve months from the date of original purchase. Any defect that arises due to faulty materials or workmanship will be repaired free of charge (or if applicable the product will be replaced or the purchase price refunded) where possible during this period by the dealer from who your purchased the unit.

### The guarantee is subject to the following provisions:

- The guarantee does not cover accidental damage, misuse, cabinet parts, knobs or consumable items.
- The product must be correctly installed and operated in accordance with the instructions contained in the manual.
- It must be used solely for domestic purposes. The guarantee will be rendered invalid if the product is re-sold or has been damaged by inexpert repair.
- Specifications are subject to change without notice.
- Alba disclaim any liability for loss or damage arising from the breakdown of the product.
- This guarantee is in addition to and does not diminish your statutory or legal rights.

Guarantor: Argos Limited - 489 - 499 Avebury Blvd. - Milton Keynes - MK9 2NW

If you require any technical guidance or find that your TV is not operating as intended, a simple solution can often be found in the **Troubleshooting** section of these instructions.



# ALBA

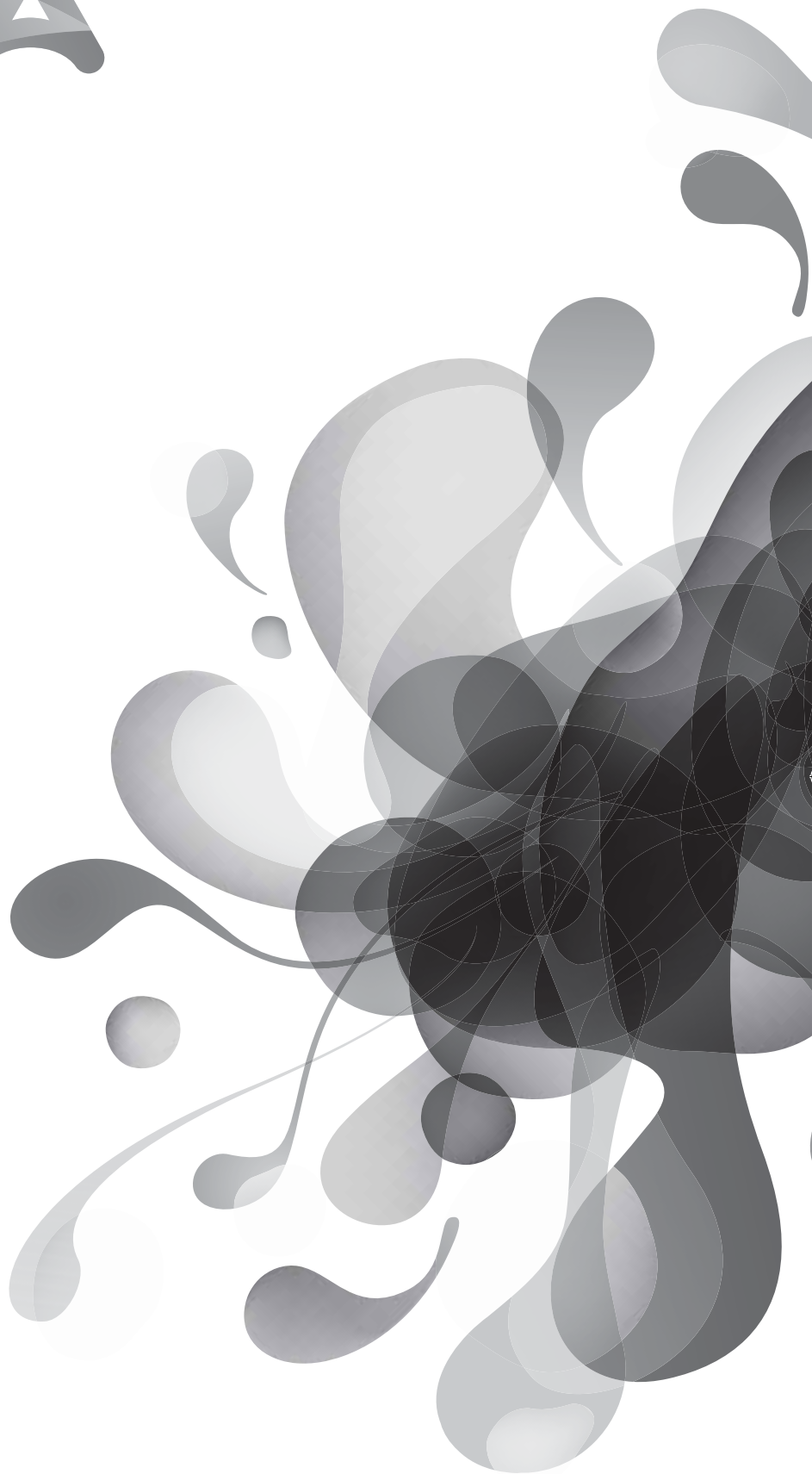

Contact:

Helpline: 0345 604 0105

