

IMPORTANT

- **WARNING:** if the door or door seals are damaged, the oven must not be operated until it has been repaired by a competent person;
- **WARNING:** it is hazardous for anyone other than a competent person to carry out any service or repair operation that involves the removal of a cover which gives protection against exposure to microwave energy;
- **WARNING:** liquids and other food must not be heated in a sealed container since they are liable to explode;
- **WARNING:** accessible parts may become hot during use. Young children should be kept away.

CAREFULLY RETAIN THESE INSTRUCTIONS

Contents

Safety Information	2-6
Materials you can use in microwave oven	7
Materials to avoid using in the microwave oven	7
Utensils	7
Setting Up your Oven	8
Oven components and accessories	8
Turntable installation	8
2 IN 1 grill stand.	9
Microwave cooking principles	9
Microwave Food Packaging Symbol	9
Accessories included	9
Installation	10-11
Please Note Electrical connection	10
Earthing installation	11
Operating your microwave oven	12-20
Clock Setting	12
Microwave Cooking	12
Grill Cooking	13
Combination Cooking	14
Multi-stage Cooking	15
Quick start Cooking	15
Pre-set Function	16
Defrost	17
Auto cook Function	17
Warming up, heating	19
Checking Stage of Cooking	20
Child Safety Lock Function	20
Cleaning your Microwave Oven	20
Troubleshooting and maintenance	21
Questions and Answers	22
Technical Specifications	23
Guarantee	24

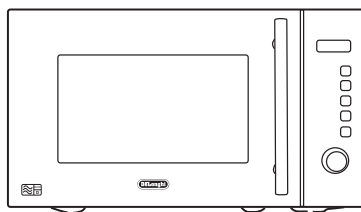

Safety Information

Important – Please read these instructions fully before installation

IMPORTANT SAFETY INSTRUCTIONS READ CAREFULLY AND KEEP FOR FUTURE REFERENCE

1. The temperature of accessible surfaces may get hot when the appliance is operating especially the metal top area and the warming rack if any.
2. This appliance is not intended for use by persons (including children) with reduced physical, sensory or mental capabilities, or lack of experience and knowledge, unless they have been given supervision or instruction concerning use of the appliance by a person responsible for their safety.
3. This appliance can be used by children aged from 8 years and above and persons with reduced physical, sensory or mental capabilities or lack of experience and knowledge if they have been given supervision or instruction concerning use of the appliance in a safe way and understand the hazards involved. Children shall not play with the appliance. Cleaning and user maintenance shall not be made by children unless they are older than 8 and supervised.
4. Keep the appliance and its cord out of reach of children less than 8 years.
5. Children should be supervised to ensure that they do not play with the appliance.

Safety Information

Important – Please read these instructions fully before installation

6. The appliance is not intended to be operated by means of an external timer or separate remote-control system.

7. The appliance is intended to be used in household and not in application such as :

- staff kitchen areas in shops, offices and other working environment;
- by clients in hotels, motels and other residential type environments;
- farm houses;
- bed and breakfast type environments.

8. **WARNING** : If the door or door seals are damaged, the oven must not be operated until it has been repaired by a competent person.

9. **WARNING** : It is hazardous for anyone other than a competent person to carry out any service or repair operation that involves the removal of a cover which gives protection against exposure to microwave energy.

10. **WARNING** : Liquids and other foods must not be heated in sealed containers since they are liable to explode.

11. A minimum clearance of 12inches (30cm) must be left above the top of the oven.

Safety Information

Important – Please read these instructions fully before installation

12. Only use utensils that are suitable for use in microwave ovens.

13. When heating food in plastic or paper containers, keep an eye on the oven due to the possibility of ignition.

14. If smoke is emitted, switch off or unplug the appliance and keep the door closed in order to stifle and flames.

15. Microwave heating of beverages can result in delayed eruptive boiling, therefore care must be taken when handling the container.

16. The contents of feeding bottles and baby food jars shall be stirred or shaken and the temperature checked before consumption, in order to avoid burns.

17. Eggs in their shell and whole hard-boiled eggs should not be heated in microwave ovens since they may explode, even after microwave heating has ended.

18. The oven should be cleaned regularly and any food deposits removed.

19. When cleaning door and oven surfaces use only mild, non-abrasive soaps or detergents applied with a sponge or soft cloth.

20. Failure to maintain the oven in a clean condition could lead to deterioration of the surface

Safety Information

Important – Please read these instructions fully before installation

which could adversely affect the life of the appliance and possibly result in a hazardous situation.

21. The microwave oven shall not be placed in a cabinet.

22. The rear surface of appliances shall be placed against a wall.

23. **WARNING** : The appliance and its accessible parts become hot during use. Care must be taken to avoid touching heating elements. Children less than 8 years of age shall be kept away unless continuously supervised.

24. Do not use harsh abrasive cleaners or sharp metal scrapers to clean the oven door glass since they can scratch the surface, which may result in shattering of the glass.

25. The appliance shall not be cleaned with a steam cleaner.

26. The microwave oven is intended for heating food and beverages. Drying of food or clothing and heating of warming pads, slippers, sponges, damp cloth and similar may lead to risk of injury, ignition or fire.

27. Metallic containers for food and beverages are not allowed during microwave cooking.

Safety Information

Important – Please read these instructions fully before installation

1. The oven must be placed on a level surface.
2. The turntable and turntable ring assembly must always be used in the oven during cooking. Place the cookware gently on the turntable and handle it carefully to avoid possible breakage.
3. Incorrect use of dish for browning food may cause turntable to break.
4. Use only the specified bag size when using pre-prepared popcorn.
5. The oven has several built-in safety switches to ensure that the power remains off when the door is open. Do not tamper with these switches.
6. Do not operate the microwave oven when empty. Operating the oven with no food or food that is extremely low in moisture can cause fire, charring or sparking.
7. Do not cook bacon directly on the turntable. Excessive local heating of the turntable may cause the turntable to break.
8. The contents of feeding bottles and baby food jars are to be stirred or shaken and the temperature should be carefully checked before consumption, in order to avoid burns.
9. Do not heat narrow-necked containers, such as syrup or sauce bottles.
10. Do not attempt to deep-fry in your microwave oven.
11. Do not attempt home canning in this microwave oven as it is impossible to be sure all contents of the jar have reached boiling temperature.
12. Do not use this microwave oven for commercial purpose. This microwave oven is made for household use only.
13. Caution : Stir the liquid prior to and during heating / reheating, let liquid stand for at least 10 seconds after cooking and always take care when adding ingredients to hot liquids. Microwave heating of beverages can result in delayed eruptive boiling, therefore care must be taken when handling the container.
14. Check the food in the microwave oven frequently to avoid burning due to overheating.
15. Failure to maintain the oven in a clean condition could lead to deterioration of the surface which could adversely affect the life of the appliance and possibly result in a hazardous situation.
16. Stand at arm's length when opening the door to avoid scalding when steam or hot air is released.
17. ALWAYS allow an appropriate standing time after the oven has switched off according to the food being cooked to allow heat to distribute evenly throughout the food.
18. Use oven gloves when removing any cookware from oven to reduce chance of being burned or scalded.
19. Read and follow the specific: "precautions for avoiding possible exposure to excessive microwave energy".
20. As with most cooking appliances, close supervision is necessary to reduce the risk of a fire in the oven cavity.
 - a. If a fire should start or smoke is observed:
 - a. Keep the oven door closed.
 - b. Turn the oven off and unplug the appliance.
21. Eggs in their shell and whole hard-boiled eggs should not be heated in microwave ovens since they may explode, even after microwave heating has ended.
22. Do not overcook food. Regularly observe the oven if paper, plastic, or other combustible materials are used in the oven.
23. Do not use the oven cavity for storage purposes. Do not store items such as bread, cookies, paper products, etc. inside the oven.
24. Remove wire twist-ties and metal handles from paper or plastic containers/bags before placing them in the oven.
25. This oven must be earthed. Connect only to properly earthed outlet. See "earthing installation".
26. Install or locate this oven in accordance with the installation instructions provided.
27. Use this appliance only for its intended uses as described in the manual. Do not use corrosive chemicals or vapours in this appliance. This oven is specifically designed to heat or cook food. It is not designed for industrial or laboratory use.
28. Never allow children to use the oven without supervision unless adequate instructions have been given so that the children are able to use the oven in a safe way and understand the hazards of improper use.
29. If the supply cord or plug is damaged, or if the oven is not working properly or has been dropped it must be replaced or repaired by the manufacturer or its service agent or a similarly qualified person in order to avoid a hazard.
30. This appliance should be serviced only by qualified service technicians. Contact the nearest authorised service facility for examination, repair or adjustment.
31. Do not cover or block any vents on the oven.
32. Do not store or use this appliance outdoors.
33. Do not use this oven near water, near a kitchen sink, in a wet basement or near a swimming pool.
34. Do not immerse cord or plug in water.
35. Keep cord away from heated surfaces.
36. Do not let cord hang over edge of table or counter.
37. When cleaning door and oven surfaces use only mild, non-abrasive soaps or detergents applied with a sponge or soft cloth.
38. Do not attempt to repair the oven yourself, please consult an authorised service agent.
39. Do not attempt to operate this oven with the door open since open-door operation can result in harmful exposure to microwave energy. It is important not to try an override or tamper with the safety interlocks.
40. Do not operate the oven if it is damaged. It is particularly important that the oven door closes properly and that there is no damage to the, (1) door (i.e. door is not bent or dented), (2) hinges and latches (broken or loosened), (3) door seals and sealing surfaces.
41. Utensils should be checked to ensure that they are suitable for use in microwave ovens.
42. The symbol  on the product or on its packaging indicates that this product may not be treated as household waste. Instead it shall be handed over to the applicable collection point for the recycling of electrical and electronic equipment. By ensuring this product is disposed of correctly, you will help prevent potential negative consequences for the environment and human health, which could otherwise be caused by inappropriate waste handling of this product. For more detailed information about recycling of this product, please contact your local city office, your household waste disposal service or the shop where you purchased the product.
43. The lamp holder must be serviced by an authorised service agent.
44. The oven should be cleaned regularly and any food deposits removed.
45. Do not use harsh abrasive cleaners or sharp metal scrapers to clean the oven door glass since they can scratch the surface, which may result in shattering of the glass.
46. Do not use steam cleaners inside the cavity.
47. During use the appliance becomes hot. Care should be taken to avoid touching heating elements inside the oven.
48. This appliance is not intended for use by persons (including children) with reduced physical, sensory or mental capabilities, or lack of experience and knowledge, unless they have been given supervision or instruction concerning use of the appliance by a person responsible for their safety.
49. The product is classified as a Group 2, Class B, ISM appliance. Group 2 includes all ISM (Industrial, Scientific or Medical) appliances in which radio frequencies are generated intentionally and/or used in the form of electromagnetic radiation to treat materials, together with electroerosion equipment. Class B includes equipment for domestic use or on premises directly connected to low voltage electricity supply for supplying buildings for residential use.
50. This appliance complies with EC directive 2014/30/EU on electromagnetic compatibility and European regulation no. 1935/2004 of 27/10/2004 on food contact materials.
51. Children should be supervised to ensure that they do not play with the appliance.
52. Material and accessories coming into contact with food conform to EC regulation 1935/2004.

MATERIALS YOU CAN USE IN MICROWAVE OVEN

Utensils	Remarks
Aluminium foil	Shielding only. Small smooth pieces can be used to cover thin parts of meat or poultry to prevent overcooking.
Arcing can occur if foil is too close to oven walls.	The foil should be a least 1 inch (2.5cm) away from oven walls.
Browning dish	Follow manufacturer's instructions. The bottom of browning dish must be at least 3/16 inch (5mm) above the turntable. Incorrect usage cause the turntable to break.
Dinnerware	Microwave-safe only. Follow manufacturer's instructions. Do not use cracked or chipped dishes.
Glass jars	Always remove lid. Use only to heat food until just warm. Most glass jars are not heat resistant and may break.
Glassware	Heat-resistant oven glassware only. Make sure there is no metallic trim. Do not use cracked or chipped dishes.
Oven cooking bags	Follow manufacturer's instructions. Do not close with metal tie. Make slits to allow steam to escape.
Paper plates and cups	Use for short-term cooking/warming only. Do not leave oven unattended while cooking.
Paper towels	Use to cover food for reheating and absorbing fat. Use with supervision for short-term cooking only.
Parchment paper	Use as a cover to prevent splattering or as a wrap during steaming.
Plastic	Microwave-safe only. Follow the manufacturer's instructions. Should be labelled "Microwave Safe". Some plastic containers soften as the food inside gets hot. "Boiling bags" and tightly closed plastic bags should be slit, pierced or vented as directed by package.
Plastic wrap	Microwave-safe only. Use to cover food during cooking to retain moisture. Do not allow plastic wrap to touch food.
Thermometers	Microwave-safe only (meat and sugar thermometers).
Wax paper	Use as a cover to prevent splattering and retain moisture.

MATERIALS TO AVOID USING IN THE MICROWAVE OVEN

Utensils	Remarks
Aluminium tray	May cause arcing. Transfer food into microwave-safe dish.
Food carton with metal handle	May cause arcing. Transfer food into microwave-safe dish.
Metal or metal-trimmed utensils	Metal shields the food from microwave energy. Metal trim may cause arcing.
Metal twist ties	May cause arcing and could cause a fire in the oven.
Paper bags	May cause a fire in the oven.
Plastic foam	Expanded polystyrene may melt or contaminate the liquid inside when exposed to high temperature.
Wood	Wood will dry out when used in the microwave oven and may split or crack.

UTENSILS

CAUTION

Personal Injury Hazard

Tightly-closed containers could explode. Closed containers should be opened and plastic pouches pierced before cooking.

See above for further instructions "Materials you can use in microwave oven or to be avoided in microwave oven." There may be certain non-metallic utensils that are not safe to use for microwaving. If in doubt, you can test the utensil in question by following the procedure below.

Utensil test:

1. Fill a microwave-safe container with 1 cup of cold water (250ml) along with the utensil in question.
2. Cook on maximum power for 1 minute.
3. Carefully feel the utensil. If the utensil is warm, do not use if for microwave cooking.
4. Do not exceed 1 minute cooking time.

Setting Up Your Oven

If you have damaged or missing parts, call the **Customer Helpline: 0345 640 3030**

OVEN COMPONENTS AND ACCESSORIES

Remove the oven and all materials from the carton.
Your oven comes with the following accessories:

Glass Tray	1
Turntable Ring Assembly	1
Instruction Manual	1
Recipe	1
Grill Stand	1

- (A) Control Panel
- (B) Turntable Shaft
- (C) Turntable Ring Assembly
- (D) Glass Turntable
- (E) Observation Window
- (F) Door Assembly
- (G) Safety Interlock System
- (H) Grill stand to be placed centred on the glass plate. (use for grilling only.)
- (I) Plug and Power Cord
- (J) Mica Cover

NOTE: Oven power turns off automatically if door is opened during operation.

fig. 1

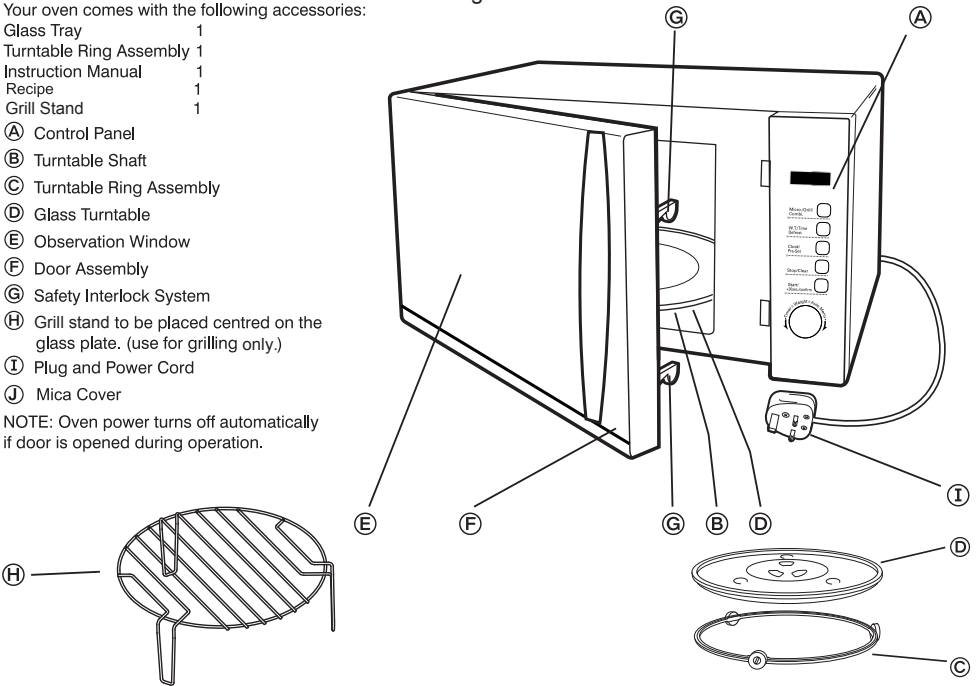

TURNTABLE INSTALLATION

- (A) Turntable Ring Assembly (C) .
To be placed in the centre of the oven to support the glass plate, (see Fig. 2)
 - (B) Hub. Rotates the glass plate (D) , (see Fig. 2)
 - (C) Glass Plate (D) . To be placed on the turntable ring with the centre fitting located on the hub. (see Fig. 2)
- a. Never place the glass turntable (D) upside down. The turntable should never be restricted in movement.
 - b. Both glass turntable (D) and turntable ring assembly (C) must always be used during cooking.
 - c. All food and containers of food should always be placed on the glass tray for cooking.
 - d. The glass turntable rotates clockwise or anti-clockwise randomly, this is normal.
 - e. If glass turntable or turntable ring assembly cracks or breaks, contact your nearest authorised service centre.

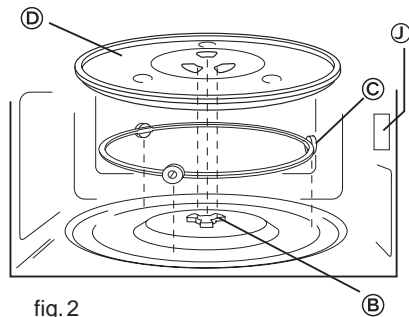

fig. 2

Warning : Do not remove the light brown Mica cover (J) that is attached to the oven cavity to protect the magnetron.

Setting Up Your Oven

GRILL STAND.

Set up for high position cooking - use for grilling only.

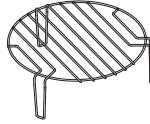

Microwave cooking principles

1. The microwaves generated by the magnetron are evenly distributed through the food as the glass turntable revolves. This ensures that the food is cooked uniformly.
2. The microwaves are absorbed by the food up to a depth of approximately 1 inch (2.5cm). Cooking continues as the heat is dissipated through the food.
3. Cooking times will vary according to the recipe and the density, weight and water content of the food. The cooking time will also vary according to the temperature at the start of cooking, i.e. depending on whether the food is frozen or not.

Microwave Food packaging Symbols

Microwave Symbols:

On the front of your oven there is a microwave symbol, as shown below. This symbol has been introduced for your benefit when cooking or reheating packaged food.

Packaged food is also increasingly using a microwave symbol similar to the one below.

When you see this symbol on food packaging the cooking instructions are based on either IEC Power Output Rating, on the Reheating Categories A,B,C,D or E.

A, B, C, D or E

MORE HEATING TIME

LESS HEATING TIME

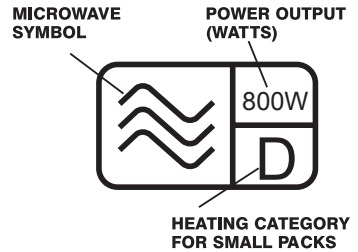

Accessories included

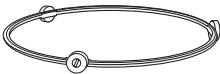

Turntable Ring Assembly



Glass Tray



Instruction



Recipe



grill stand

Installation

Please Note Electrical connection

The oven is fitted with a plug and must be only connected to a properly installed earthed socket. In accordance with the appropriate regulations, the socket must only be installed and the connecting cable must only be replaced by a qualified electrician. If the plug is no longer accessible following installation and all-pole isolating switch must be present on the installation side with a contact gap of at least 3mm.

1. Select a level surface that provide enough open space for the intake and/or outlet vents.

The rear surface of the appliance shall be placed against a wall.
One side must be open.

- (1) Leave a minimum clearance of 12 inches (30cm) above the oven.
 - (2) Do not remove the legs from the bottom of the oven.
 - (3) Blocking the intake and/or outlet openings can damage the oven.
 - (4) Place the oven as far away from radios and TV as possible.
Operation of microwave oven may cause interference to your radio or TV reception.
2. Plug your oven into a standard household outlet. Be sure the voltage and the frequency is the same as the voltage and the frequency on the rating label.

WARNING: Do not install oven over a range cooktop or other heat-producing appliance. If installed near or over a heat source, the oven could be damaged and the warranty would be void.

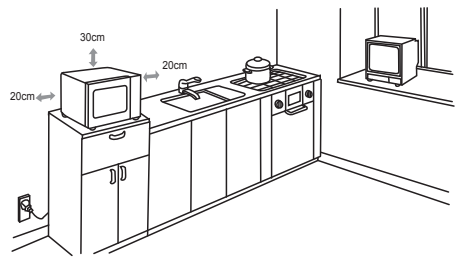

Installation

EARTHING INSTALLATION

DANGER

Electric Shock Hazard

Touching some of the internal components can cause serious personal injury or death.

Do not disassemble this appliance.

WARNING

Electric Shock Hazard

Improper earthing can result in electric shock.

Do not plug into an outlet until appliance is properly installed and earthed.

Three pin earthed plug Properly polarised and earthed outlet.

This appliance must be earthed. In the event of an electrical short circuit, grounding reduces the risk of electric shock by providing an escape wire for the electric current. This appliance is equipped with a cord having a grounding wire with an earthing plug. The plug must be plugged into an outlet that is properly installed and earthed.

Consult a qualified electrician or serviceman if the earthing instructions are not completely understood or if doubt exists as to whether the appliance is properly earthed. If it is necessary to use an extension cord, use only a 3-wire extension cord that has a 3 pin earthing plug, and a 3-slot socket which will accept the plug.

A short power-supply cord is provided to reduce the risks resulting from becoming entangled in or tripping over a longer cord.

Check that the voltage marked on the product corresponds with your supply voltage.

This product is fitted with a 13 A plug complying with BS1363. If this plug is unsuitable or needs to be replaced, please note the following:

Important: The wires in the mains lead are coloured in accordance with the following code:

GREEN / YELLOW – EARTH,

BLUE – NEUTRAL, BROWN – LIVE

For UK use only

Plug fitting details (where applicable):

As the colours of the wires in the mains lead of this appliance may not correspond with the coloured markings identifying the terminals in your plug proceed as follows:

The GREEN/YELLOW wire is the EARTH and must be connected to the terminal which is marked with the letter (E) or by the earth symbol or coloured GREEN or GREEN/YELLOW.

The BLUE wire is the NEUTRAL and must be connected to the terminal marked with the letter (N) or coloured BLACK.

The BROWN wire is the LIVE and must be connected to the terminal marked with the letter(L) or coloured RED.

Always ensure that the plug cord grip is fastened correctly.



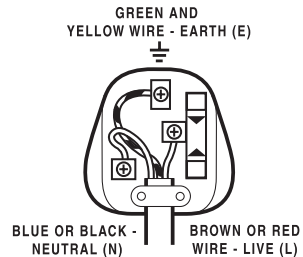

If a 13A (BS 1363) fused plug is used it must be fitted with a 13A fuse conforming to BS1362 and be ASTA approved.

If in doubt contact a qualified electrician.



1 . CLOCK SETTING

Your microwave oven is equipped with a clock. You must set the clock when you first install your oven or after a power failure.







- 1) Press "  " once, "0:00" will flash .
- 2) Turn "  " to adjust the hour figure (0 to 23 (24 hours)setting)
- 3) Press "  ", the minute figure will flash.
- 4) Turn "  " to adjust the minute figure.
- 5) When the right time is displayed,press "  " to start the clock.

Note: 1) ":" will flash when time has been set.

- 2) During the process of clock setting, if you press "  ", the oven will go back to the previous status .
- 3) Do not forget to reset the clock when you switch to and from summer or winter time.

2 . MICROWAVE COOKING

The following procedures explains how to cook the food.

- 1) Open the door,place the food in the center of the turntable and close the door.
- 2) Press "  " once to select the microwave cooking, then continue to press "  " or turn "  " to select required microwave power P100,P80,P50,P30,P10.
- 3) Press "  " to confirm.
- 4) Turn "  " to adjust the cooking time (The maximum setting time is 95 minutes.)
- 5) Press "  " to start cooking.
- 6) To stop the cooking process at anytime by pressing the "  " "
- 7) The oven will beep 5 times when the cooking process has finished

NOTE: The cooking time can be adjusted in the following increments:

- 0---1 min : 5 seconds
- 1---5 min : 10 seconds
- 5---10 min : 30 seconds
- 10---30 min : 1 minute
- 30---95 min : 5 minutes

Never switch the microwave on when it is empty.

The power level function enables you to adopt the amount of energy dissipated and thus the time required to cook or re-heat your food, according to its type and quantity. you can choose five power level

Microwave Power Chart

No. of time to press on

"  " button	Microwave Power Level		Display
1	100% Power	(800W)	P 100
2	80% Power	(640W)	P 80
3	50% Power	(400W)	P 50
4	30% Power	(240W)	P 30
5	10% Power	(80W)	P 10

3 . GRILL COOKING

This function enables you to hear and brown food quickly without microwave.

Open the door and place the food on the grill stand.

1) Press "  " once, the LED displays "P100"

2). Turn "  " to select required grill power.

"G" displays when grill is selected.

3) Press "  " to confirm

4) Turn "  " to set the cooking time. (The maximum setting time is 95 minutes.)

5) Press "  " to start the cooking.

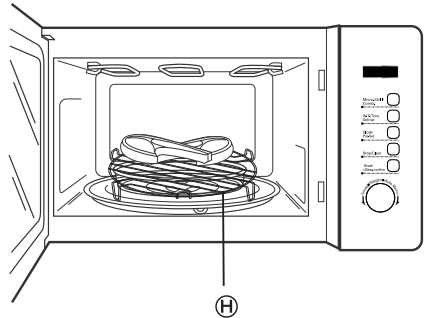

Note: the temperature of the grill cannot be set.

Note : When the cooking time is halfway through, the oven will produce two beep sounds to let you know. This is normal. If you want to turn the food over, you can open the door and oven will stop immediately. You can now turn the food over and close the door. Then press

"  " to continue the cooking. If you do not need to turn the food over, you can just leave it to continue to cook.

Note : Always use the grill stand for grill cooking.

4. COMBINATION COOKING

You can combine microwave cooking with the grill, to cook quickly and brown at the same time.



Always use microwave-safe and oven-proof cookware. Glass or ceramic dishes are ideal as they allow the microwaves to penetrate the food evenly.



Always use oven gloves when touching the recipients in the oven, as they will be very hot."

There are two cooking methods (C-1, C-2,) for you to select.

1) Open the door. Place the food on the grill stand best suited to the type of food to be cooked. Place the stand on the turntable. Close the door.

Press "  " once, "P100" will flash.

2) Select the appropriate power level by pressing "  " or turn "  " to select one of the combinations methods shown below.

Combination	LED Display	Microwave Power	Grill Power
1	 - 1	55%	45%
2	 - 2	36%	64%

3) Press "  " to confirm the combination .

4) Turn "  " to adjust the cooking time. The maximum cooking time is 95 minutes.







5) Press "  " to start cooking.

5 . MULTI-STAGE COOKING

Your microwave oven can be programmed to cook food in 2 stages. Example: You wish to power defrost food and cook it without having to reset the oven after defrost stage.

You can also cook with 100% power microwave for 10 minutes + Grill cooking for 5 minutes.

The steps are as following:

- 1) Press " " once to choose 100% microwave power;
- 2) Press " " to confirm.
- 3) Turn " " to adjust the cooking time of 10 minutes;
- 4) Press " " several times, "G" will flash;
- 5) Press " " to confirm;
- 6) Turn " " to adjust cooking time of 5 minutes;
- 7) Press " " to start cooking.

Note : (1) If one of the stages is defrosting, the defrost cooking will be started at the 1st stage automatically.

(2) The buzzer will ring once after each stage and the next stage will begin.

(3) Auto menu cannot apply to one of the stages of multi-stage cooking



6 . QUICK START COOKING

There are two ways to quick start the cooking.

- 1) Press " " button to cook with 100% power level for 30 seconds.

Each press on the same key can increase 30 seconds. The maximum cooking time is 95 minutes.

During Microwave, grill, Combi. and time defrost process, press " " to increase cooking time. Each press will increase 30 seconds.

- 2) Turn " " left to set cooking time with 100% microwave power, then press " " to start cooking.

Note: To stop the cooking process at anytime by pressing the " " .

When using the Defrost by weight function and Microwave auto function, the cooking time cannot be added by pressing " " .





7 . PRE-SET FUNCTION

You microwave oven will start working automatically when you are using this function,









1. You must set the clock first.
2. Set the function you like based on the previous procedures except not pressing the button  until the last step.

Note: Clock symbol will flash when setting.

3. Follow the below steps to set the Pre-set function.

- 1) Press "  " once, "0:00" will displayed .
- 2) Turn "  " to adjust the hour (0 to 23 for 24 hour setting)
- 3) Press "  ", the minute will flash.
- 4) Turn "  " to adjust the minute.
- 5) Finally, press "  " to confirm the timer.

Example: If you want to cook with 100% microwave power for 10 minutes at 15:00.

- 1) Press "  " once to choose 100% microwave power;
- 2) Press "  " to confirm.
- 3) Turn "  " to adjust the cooking time of 10 minutes;
- 4) Press "  " once to choose the preset time;
- 5) Turn "  " to adjust the hour until it displays "15:00";
- 6) Press "  ", the minutes will flash;
- 7) Turn "  " to adjust the minute until it displays "15:00";
- 8) Finally, press "  " to confirm the timer.



At 15:00, the microwave function will start automatically.

8 . DEFROST



The defrost function enables you to defrost meat, poultry, fish, etc. The defrost power level are set automatically, you simply select defrost by weight or by time. Use only containers that are microwave-safe.

Open the door, place the frozen food on a ceramic in the center of the turntable. Close the door and follow the below steps.

A. Defrost by weight

- 1) Press "  " button once, the oven will display "dEF1".
- 2) Turn "  " to select the weight of food. You can set the weight between 100 to 2000g.
- 3) Press "  " button to start defrosting.
- 4) After the defrosting is finished, the oven will beep five times.





B. Defrost by time

- 1) Press "  " button twice, the oven will display "dEF2".
- 2) Turn "  " to select the time of defrosting food. You can set the time between 0 to 95 mins.
- 3) Press "  " button to start defrosting.
- 4) After the defrosting is finished, the oven will beep five times.

9 . AUTO COOK FUNCTION

The Eight Auto Cook functions provide pre-programmed cooking times. You do not need to set either the cooking times or power level, simply adjust the size of the serving by turning the dial.

The Table in the next page shows the time taken to cook based on the food weight,

- 1). Turn "  " right to choose desire auto function i.e. A1 to A8.
- 2). Press "  " to confirm setting i.e. A1 to A8.
- 3). Turn "  " to select the weight / portion.
- 4). Press "  " to start cooking.

9 . AUTO COOK FUNCTION

Auto Cook Menu

Menu	Weight(g)	Display	Power
A-1 AUTO REHEAT	200	200	100%
	400	400	
	600	600	
A-2 VEGETABLE	200	200	100%
	300	300	
	400	400	
A-3 FISH	250	250	80%
	350	350	
	450	450	
A-4 MEAT	250	250	100%
	350	350	
	450	450	
A-5 PASTA	50(with water 450 g)	50	80%
	100(with water 800 g)	100	
A-6 POTATO	200	200	100%
	400	400	
	600	600	
A-7 PIZZA	200	200	100%
	400	400	
A-8 SOUP	200	200	80%
	400	400	



WARMING UP, HEATING

Times stated are approximate and can vary depending on the quality, size of the chopped pieces, storage temperature and moisture content of the foodstuff. It is advisable to set a shorter cooking time at first, and then if necessary continue the cooking process, until the food is cooked to your satisfaction.

Foodstuff	Quantity	Output	Level	Time (Mins)	Remarks
Liquids					
Milk, 1 cup	150g	P100 (=100%)		0.5 - 1	Caution: Stir the liquid prior to and during heating/reheating, let liquid stand for at least 10 seconds after cooking and always take care when adding ingredients to hot liquids.
Water/Coffee/Milk 1 cup	150g	P100 (=100%)		2 - 1	Caution: Stir the liquid prior to and during heating/reheating, let liquid stand for at least 10 seconds after cooking and always take care when adding ingredients to hot liquids.
Water	500g	P100 (=100%)		3 - 5	Caution: Stir the liquid prior to and during heating/reheating, let liquid stand for at least 10 seconds after cooking and always take care when adding ingredients to hot liquids.
One-course meals/ Ready-to-serve meals	450g	P100 (=100%)		4 - 6	Cover.
Soups	250g	P100 (=100%)		1 - 2	Stir.
Stews	500g	P100 (=100%)		3 - 5	Stir between times.
Meat / Poultry					
Roast	250g	P100 (=100%)		2 - 3	
Rissoles/Meatballs	500g	P100 (=100%)		3 - 4	
1/2 Chicken	450g	P100 (=100%)		3 - 4	Lightly brush with oil.
Vegetables					
Portion x 1	150g	P100 (=100%)		1 - 2	Cover, stir.
Portions x 2	300g	P100 (=100%)		2 - 4	Cover, stir.
Side Dishes					
Noodles	150g	P100 (=100%)		1 - 2	Dampen slightly beforehand, cover, stir.
Rice	150g	P100 (=100%)		1 - 2	Dampen slightly beforehand, cover, stir.
Potatoes	500g	P100 (=100%)		3 - 4	Cover.
Baby Food	approx, 200g	P100 (=100%)		1 - 2	Stir well, check the temperature.
Meat					
Beef, Pork in one piece	500g	P 80 (= 80%)		11 - 14	Cover, turn halfway through cooking, leave to stand for 3-5 minutes.
Lightly smoked pork loin	500g	P 80 (= 80%)		12 - 15	
Meatloaf		P100 (=100%)		12 - 15	
Sausages	200g	P 80 (= 80%)		2 - 3	Pierce skin with fork.
Poultry					
Chicken	1000g	P100 (=100%)		20 - 25	Cover, turn once, leave to stand for 5 minutes.
Pieces of Chicken	250g	P 80 (=80%)		4 - 5	
Fish					
Fresh fish	300g	P 80 (= 80%)		5 - 7	Cover, turn once, leave to stand for 3 minutes.
Fillet of fish	300g	P 80 (= 80%)		4 - 5	Cover, turn once, leave to stand for 3 minutes.
Frozen fish	400g	P100 (=100%)		8 - 10	Cover, leave to stand for 3 minutes.
Vegetables, fresh					
Cauliflower, broccoli, fennel	150g	P100 (=100%)		8 - 10	Chop vegetables into small pieces, cook with liquid, (3-5 tablespoons), stir in between times leave to stand for 3-5 minutes, add spices, (salt before serving).
French beans	500g	P100 (=100%)		10 - 12	
Potatoes, boiled potatoes	500g	P100 (=100%)		8 - 10	
Jacket potatoes	500g	P100 (=100%)		10 - 12	Prick the jacket for boiling potatoes.
Carrots	500g	P100 (=100%)		8 - 10	
Vegetables, deep frozen					
Leaf spinach	300g	P100 (=100%)		10 - 12	Take note of details on the packaging. Cover, add some liquid, stir in between times, leave to stand for 3 - 3 minutes.
Peas	300g	P100 (=100%)		7 - 9	
Leeks	200g	P100 (=100%)		10 - 12	
Carrots	200g	P100 (=100%)		6 - 8	
Brussel sprouts	250g	P100 (=100%)		6 - 8	
Spinach	150g	P100 (=100%)+ P 30 (= 30%)		3 - 4 20 - 22	
Deserts					
Pudding/Flummery	500g	P100 (=100%)		6 - 8	

10 . CHECK COOKING STAGE

If you would like to know the current power level of the oven cavity or time

- (1) You may press "  ", it will display the current power, e.g. P100, after three seconds, it will revert to the former time count down.
- (2) You may press "  ", it will display the current time, e.g. 15:12, after three seconds, it will revert to the former time count down.

11 . CHILD SAFETY LOCK FUNCTION

Your microwave oven is fitted with a special Child Safety Lock Function, which enables the oven to be "locked", to prevent the children or anyone who does not familiar with it can operate the microwave oven accidentally.

To Lock: Hold the button "  " for 3 seconds, a long "beep" will be heard denoting entering into the children-lock state and display **[- - -]**.

To Unlock: Hold the button "  " for 3 seconds, a long "beep" will be heard, denoting entering into the children-unlock state, then it can be unlocked.

CLEANING YOUR MICROWAVE OVEN

Attention

Your microwave oven should be cleaned regularly to prevent grease and food particles from building up on the inside surface. The accumulated grease / food particles may cause a fire hazard.

It is important to clean the interior of your microwave oven after each use.

To clean the oven interior, use a mild detergent solution, such as washing-up liquid, with warm water on a soft cloth.

It is suggested to place half a lemon in a bowl and add 300ml water inside the oven. Then heat it on 100% microwave power setting for 10 minutes. Wipe the oven clean with a soft, dry cloth.

IMPORTANT:

ALWAYS switch off oven and unplug from power supply.

ALWAYS use a branded cleaning spray, and for stubborn spots inside the oven, spray a small amount of cleaner onto a damp cloth.

DO NOT SPRAY DIRECTLY INSIDE THE OVEN.

Removable Parts

1. The turntable may be cleaned at the sink. Be careful not to chip or scratch the edges as this may cause the turntable to break during use.
2. The turntable roller rest should be cleaned regularly.
3. Do not immerse the turntable glass in cold water.

Special Care

For best performance and safety, the inner door panel and the oven front frame should be free of food residue. To prevent damage to the operating parts inside the oven, water should not be allowed to seep into the ventilation openings.

Troubleshooting and maintenance

NORMAL CONDITION

Microwave oven interfering with TV reception.

Radio and TV reception may be interfered with when microwave oven is in operation. It is similar to the interference of small electrical appliances such as food mixers, vacuum cleaners and electric fans. This is normal.

Oven light dim.

In low power microwave cooking, oven light may become dim. This is normal.

Steam accumulating on door, hot air out of vents.

In cooking, steam may come out of food. Most will come out from vents but some may condense on cool places such as the oven door. This is normal.

Oven started accidentally with no food in.

Although starting the oven with no food in it should be avoided, it does no damage to the oven provided it is only operated empty for a very short time. It is advised that a glass or microwave safe container of water is always left in the oven to absorb any heat should the oven be turned on accidentally.

MAINTENANCE

Troubleshooting

Check for problems by using the chart below. If the microwave oven still does not work properly, contact the nearest authorised service centre.

PROBLEM	POSSIBLE CAUSE
Oven will not start	a. Plug not secure in power socket, or not switched on. b. Door is open. c. Wrong operation is set.
Arcing or sparking	a. Materials which should be avoided in microwave oven are used. b. The oven is operated when empty. c. Spilled food remains in the cavity.
Unevenly cooked food	a. Materials which should be avoided in microwave oven are used. b. Food is not defrosted completely. c. Power setting for cooking time is incorrect. d. Food is not turned or stirred.
Overcooked food	Power setting for cooking time is incorrect.
Undercooked food	a. Materials to be avoided in microwave oven are used. b. Food is not defrosted completely. c. Oven ventilation ports are restricted. d. Power setting for cooking time is incorrect.
Incomplete defrosting	a. Materials to be avoided in microwave oven are used. b. Power setting for cooking time is incorrect. c. Food is not turned or stirred.
Noise comes from turntable when oven is turned on	a. Food residue exists between the turntable roller rest and cavity bottom.
Oven light does not glow	a. The light bulb has burned out, a new bulb must be fitted by a qualified service engineer. b. START has not been pressed.

Questions and Answers

- Q: When the oven is plugged into a wall outlet for the first time, it does not work properly. What's wrong?
A: The microcomputer used in the oven control may temporarily become scrambled and fail to function as programmed. Unplug the oven from the wall outlet and then plug it back in. The microcomputer will then reset for proper functioning.
- Q: Why is there noise coming from the oven when using a lower power level?
A: When cooking with power other than 100%, the oven automatically switches on and off to obtain the correct power output. The clicking noise can be heard when the oven switches on and off. This is normal.
- Q: Why is there steam coming out of the air exhaust vent?
A: Steam is produced during cooking. The microwave oven has been made to vent this steam.
- Q: What is wrong when the oven light will not glow?
A: There may be several reasons why the oven light will not glow. The light bulb has burned out or START has not been pressed.
- Q: Why do eggs sometimes burst?
A: The egg yolk may burst because of steam build-up inside the membrane. Pierce the membrane with a toothpick before cooking it. Never microwave eggs in the shell as they may explode.
- Q: How is boiling over avoided?
A: Use a larger utensil than usual for cooking. If you open the oven door or touch STOP/CLEAR, the food will stop boiling.

IMPORTANT NOTES

1. Before first using this oven please read this instruction manual and keep it carefully.
2. Do not attempt to repair the oven yourself, please consult a service agent.
3. The contents of feeding bottles and baby food jars are to be stirred or shaken and the temperature should be carefully checked before consumption, in order to avoid burns.
4. Check the oven and the cable regularly for damage. If there is any kind of damage, the oven should not be used.

Warning:

- a. It is hazardous for anyone other than a service agent to carry out any service or repair operation which involves the removal of any cover which gives protection against exposure to microwave energy.
- b. Never allow children to use the oven without supervision unless adequate instructions have been given so that the children are able to use the oven in a safe way and understand the hazards of improper use.
- c. If the supply cord is damaged, it must be replaced by the manufacturer or its service centre or a similarly qualified person in order to avoid a hazard.

NOTE

- Do not attempt to operate this oven with the door open since open-door operation can result in harmful exposure to microwave energy. It is important not to try and override or tamper with the safety interlocks.
- Carefully clean door seals and sealing surfaces.
- Do not operate the oven if it is damaged. It is particularly important that the oven door closes properly and that there is no damage to the, (1) door (i.e. door is not bent or dented), (2) hinges and latches (broken or loosened), (3) door seals and sealing surfaces.
- Utensils should be checked to ensure that they are suitable for use in microwave ovens.
- When heating food in plastic or paper containers, check the oven frequently to avoid any possibility of ignition.
- Microwave heating of beverages can result in delayed eruptive boiling, therefore care has to be taken when handling the container.
- If smoke is observed, switch off or unplug the appliance immediately and keep the door closed in order to stifle any flames.
- Eggs in their shells and whole hard-boiled eggs should not be heated in microwave ovens since they may explode.
- If the door or door seals are damaged the oven must not be operated until it has been repaired by a service agent.
- Liquids or other foods must not be heated in sealed containers since they are liable to explode.
- Warning: Children should only use this oven under adult supervision.
- When heating food in plastic or paper containers, keep an eye on the oven due to the possibility of ignition.
- The temperature of accessible surfaces may be high when the appliance is operating. The surfaces are liable to get hot during use. Keep cord away from heated surface, and do not cover any events on the oven.
- Children should be supervised to ensure that they do not play with the appliance.
- The appliances are not intended to be operated by means of an external timer or separate remote-control system.

BULB REPLACEMENT

If the interior light bulb fails, it can be easily replaced by a qualified service engineer. Do not attempt to remove the outercasing, as this will expose live components. Please consult a qualified service engineer.

Technical Specifications

Model	AG820CMF
Power Source:	230-240V~ 50Hz
Microwave Power Consumption:	1200-1270 W
Maximum Output:	750-800 W
Grill Power Consumption:	950-1000 W
Oven Capacity:	20litres
Turntable Diameter:	Ø 255mm
External Dimensions (L x W x H):	440 mm x328 mm x 259 mm
Net Weight:	Approx. 11.85 kg

We apologise for any inconvenience caused by any minor inconsistencies in these instructions, which may occur as a result of product improvements and development.

For future help please call the Customer Helpline: 0345 640 3030



PRODUCT GUARANTEE

This product is guaranteed against manufacturing defects for a period of



Year

This product is guaranteed for twelve months from the date of original purchase.

Any defect that arises due to faulty materials or workmanship will either be replaced, refunded or repaired free of charge where possible during this period by the dealer from whom you purchased the unit.

The guarantee is subject to the following provisions:

- The guarantee does not cover accidental damage, misuse, cabinet parts, knobs or consumable items.
- The product must be correctly installed and operated in accordance with the instructions contained in this manual.
- It must be used solely for domestic purpose.
- The guarantee will be rendered invalidated if the product is re-sold or has been damaged by inexpert repair.
- Specifications are subject to change without notice.
- The manufacturer disclaims any liability for the incidental or consequential damages.
- The guarantee is in addition to, and does not diminish your statutory or legal rights.
- In the event of a problem with the product within the guarantee period call the Customer Helpline on 0345 640 3030.

Guarantor: Argos Ltd
489 - 499 Avebury Boulevard
Central Milton Keynes
MK9 2NW

