

## Contents

Support.....	7
Environmental Information.....	8
Features .....	8
Accessories Included.....	8
Standby Notifications.....	8
TV Control Switch & Operation.....	9
Inserting the Batteries into the Remote .....	9
Connect Power .....	9
Antenna Connection.....	9
License Notification .....	9
Disposal information.....	10
Specification .....	10
Remote Control .....	12
Connections.....	13
Switching On/Off.....	14
First Time Installation.....	14
Media Playback via USB Input .....	14
Media Browser Menu.....	15
FollowMe TV (if available) .....	15
CEC and CEC RC Passthrough.....	15
TV Menu Contents.....	16
General TV Operation .....	20
Using the Channel List .....	20
Configuring Parental Settings.....	20
Electronic Programme Guide (EPG) .....	20
Teletext Services .....	21
Software Upgrade.....	21
Troubleshooting & Tips.....	21
PC Input Typical Display Modes.....	23
AV and HDMI Signal Compatibility .....	23
Supported Video File Formats for USB Mode .....	24
Supported Picture File Formats for USB Mode .....	24
Supported Audio File Formats for USB Mode .....	25
Supported Subtitle File Formats for USB Mode .....	26
Supported DVI Resolutions .....	27
Internet Portal .....	31
Freeview Play Platform.....	31
Integrated Catch-Up Services .....	32
Internet Browser .....	32
Smart Center .....	33
DVB-T functionality information .....	35
Internet Portal functionality information .....	35
Guarantee.....	36

## Important safety precautions

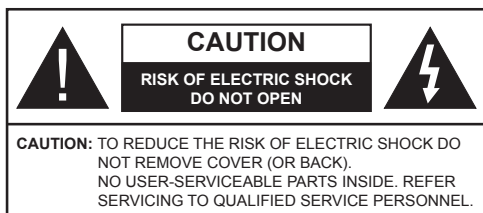

**Don't operate your TV in extreme ambient conditions as this may cause damage to your TV.**



The lightning flash with arrowhead symbol, within an equilateral triangle, is intended to alert the user to the presence of uninsulated "dangerous voltage" within the product's enclosure that may be of sufficient magnitude to constitute a risk of electric shock of persons.



The exclamation point within an equilateral triangle is intended to alert the user to the presence of important operating and maintenance (servicing) instructions in the literature accompanying the appliance.

*Note: Follow the on screen instructions for operating the related features.*

## **IMPORTANT - Please read these instructions fully before installing or operating**

### Preparation

Place the device on a solid even surface. For ventilation, leave a free space of at least 10 cm all around the set. To prevent any fault and unsafe situations, do not place any objects on top of the set. Use this device in moderate climates.

**Operation temperature and operation humidity:** 0°C up to 40°C, 85% rel. humidity max. (not blocking ventilation openings).

### Intended Use

This device is used to receive and display TV programmes. The different connection options make an additional expansion of the reception and display sources possible (various external devices). This device is only suitable for dry interior use. This appliance is intended solely for private domestic use and may not be used for industrial and commercial purposes. We exclude liability in principle, if the device is not used as intended, or unauthorized modifications have been made. To operate your TV in extreme ambient conditions may cause the damage of the device.

**This appliance is not intended for use by persons (including children) with reduced physical, sensory or mental capabilities, or lack of experience and knowledge, unless they have been given supervision or instructions concerning use of the appliance by a person responsible for their safety. Children should be supervised to ensure that they do not play with the appliance.**

**Children may not recognize dangers. The swallowing of batteries can be fatal. Keep batteries always out of reach of small children. If a battery is swallowed, seek immediate medical attention. Keep the packaging films out of reach of children, there is a risk of suffocation.**

Use this TV set at an altitude of less than 2000 meters above the sea level, in dry locations and in regions with moderate or tropical climates.

To avoid danger of suffocation, keep plastic bags out of the reach of the babies, children and domestic animals.

Carefully attach the stand to the TV. If the stand is provided with screws, tighten the screws firmly to prevent the TV from tilting. Do not over-tighten the screws and mount the stand rubbers properly.

\*\*\*\*\*

**Please read the following recommended safety precautions carefully for your safety.**

### **SOME DO'S AND DON'TS ON THE SAFE USE OF EQUIPMENT**

This equipment has been designed and manufactured to meet international safety standards but, like any electrical equipment, care must be taken if you are to obtain the best results and safety is to be assured.

\*\*\*\*\*

**DO** read the operating instructions before you attempt to use the equipment.

**DO** ensure that all electrical connections (including the mains plug, extension leads and inter-connections between the pieces of equipment) are properly made and in accordance with the manufacturer's instructions. Switch off and withdraw the mains plug before making or changing connections.

**DO** consult your dealer if you are ever in doubt about the installation, operation or safety of your equipment.

**DO** be careful with glass panels or doors on equipment.

**DO** route the mains lead so that it is not likely to be walked on, crushed, chafed, or subjected to excessive wear and tear or heat.

\*\*\*\*\*

**DON'T** remove any fixed cover as this may expose dangerous voltages.

**DON'T** obstruct the ventilation openings of the equipment with items such as newspapers, tablecloths, curtains, etc. Overheating will cause damage and shorten the life of the equipment.

**DON'T** allow electrical equipment to be exposed to dripping or splashing, or objects filled with liquids, such as vases, to be placed on the equipment.

**DON'T** place hot objects or naked flame sources such as lighted candles or nightlights on, or close to equipment. High temperatures can melt plastic and lead to fires.

**DON'T** use makeshift stands and **NEVER** fix legs with wood screws - to ensure complete safety always fit the manufacturer's approved stand or legs with the fixings provided according to the instructions.

**DON'T** listen to headphones at high volume, as such use can permanently damage your hearing.

**DON'T** leave equipment switched on when it is unattended unless it is specifically stated that it is designed for unattended operation or has a stand-by mode. Switch off using the switch, on the equipment and make sure that your family know how to do this. Special arrangements may need to be made for infirm or handicapped people.

**DON'T** continue to operate the equipment if you are in any doubt about it working normally, or if it is damaged in any way - switch off, withdraw the mains plug and consult your dealer.

#### **ABOVE ALL**

**--- NEVER let anyone especially children push anything into holes, slots or any other opening in the case - this could result in a fatal electrical shock;**

**--- NEVER guess or take chances with electrical equipment of any kind**

**--- It is better to be safe than sorry!**

#### **Power source**

- The TV should be operated only from a 220-240 V AC, 50 Hz outlet.

**⚠ WARNING: Do not leave your TV in standby or operating mode when you leave your house.**

#### **Positioning the TV**

- For ventilation, please leave a clear space of at least 10cm all around the TV.

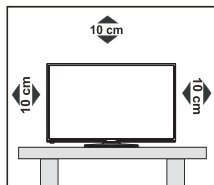

- **Do not** block the ventilation openings.
- **Do not** place the TV on sloping or unstable surfaces, the TV may tip over.
- To prevent damage to the TV, **do not** place any objects on top of the TV.

#### **Power cord and plug**

- Do not place the set, a piece of furniture, etc. on the power cord (mains lead) or pinch the cord. Handle the power cord by the plug. Do not pull the plug by holding its neck, as this could result in damage to the plug. Do not unplug the appliance by pulling from the power cord and never touch the power cord with wet hands as this could cause a short circuit or electric shock. Never make a knot in the cord or tie it with other cords. The power cords should be placed in such a way that they are not likely to be stepped on. A damaged power cord can cause fire or give you an electric shock. When it is damaged and needs to be replaced, it should be done by qualified personnel.
- This TV receiver is supplied with a moulded mains plug. The mains plug must not be cut off, as it may contain a special radio interference filter, the removal of which could lead to impaired performance. If you wish to extend the lead, obtain an appropriate safety approved extension lead or consult your dealer.
- Observe the manufacturers instructions when connecting extension leads to the set. Check the fuse rating on the new plug; this should be fitted with a 5 Amp fuse which conforms to either ASTA or BSI (BS1362) approvals, these are easily identifiable by either the ⚡ or ⚡ symbols. If you are in any doubt about the installation of an extension lead, please consult a competent electrician.

#### **Moisture and Water**

- **Do not** use this TV in a humid or damp place (avoid bathrooms, the sink in the kitchen, and near the washing machine).
- **Do not** expose this TV to rain or water.
- **Do not** place objects filled with liquids, such as flower vases, on top of the TV. Avoid from dripping or splashing.
- If any solid object or liquid falls into the cabinet, unplug the TV and have it checked by qualified personnel before operating it any further.

#### **Ventilation**

- The slots and openings on the TV set are intended for ventilation and to ensure reliable operation.
- To prevent overheating, these openings must not be blocked or covered in anyway.

#### **Heat sources and Flames**

- **Do not** expose the TV to direct sunlight or other heat sources.

- The TV should not be placed near to open flames and sources of intense heat such as an electric heater.

- Ensure that no open flame sources, such as lit candles, are placed on top of the TV.



## Headphone Volume

- Excessive sound pressure from earphones and headphones can cause hearing loss, please take care.



## Wall Mounting (optional)

- To prevent injury, this TV must be securely attached to the wall in accordance with the installation instructions (if the option is available).

## LCD Screen

- Occasionally, a few non-active pixels may appear on the screen as a fixed blue, green or red point. Please note that this does not affect the performance of your product.
- Take care not to scratch the screen with fingernails or other hard objects.

## Cleaning

- Before cleaning, unplug the TV from the wall socket.
- **Do not** use liquid or aerosol cleaners. Only use a soft, dry cloth.

## Batteries

**! WARNING:** *Incorrect installation of batteries may cause battery leakage and corrosion, resulting in damage to the remote control.*

- **Do not** mix old and new batteries, or batteries of different types.
- **Do not** dispose of batteries in a fire.
- **Do not** dispose of batteries with normal household waste, take to a local recycling centre.



**! CAUTION:** *Insert the batteries / rechargeable batteries in the correct polarity. Don't try to recharge non rechargeable batteries and under no circumstances throw them into fire. Danger of explosion. Do not use unequal batteries (old and new, Alkaline and carbon, etc.) simultaneously. If you will not use the device for a long time, remove the batteries and store the device in a dry and dust free place. Improper use of batteries may cause an explosion or leakage. If the batteries have leaked, use gloves and clean the appliance thoroughly with a dry cloth! Batteries should not be exposed to heat, such as sunshine, fire or the like.*

## Replacement Parts

When replacement parts are required, make sure that the service technician has used replacement parts, which are specified by the manufacturer or have the

same specifications as the original one. Unauthorised substitutions may result in fire, electrical shock or other hazards.

## Taking out of service and storing

Unplug the TV from the mains and pack the TV in an appropriate cardboard box. Remove the batteries from the remote control and pack the remote control with the TV set.



**NOTE:** *The TV set should be stored in a dry and dust-free room.*

## Connection to a Television Distribution System (Cable TV etc.) from Tuner

Device connected to the protective earthing of the building installation through the mains connection or through other apparatus with a connection to protective earthing-and to a television distribution system using coaxial cable, may in some circumstances create a fire hazard.

Connection to a cable distribution system has therefore to be provided through a device providing electrical isolation below a certain frequency range (galvanic isolator, see EN 60728-11).



## CAUTION

Do not put your fingers in the middle between the TV and stand, especially when you carry the TV, as they may be injured.

## WARNING

Do not ingest the battery, Chemical Burn Hazard  
This product or the accessories supplied with the product may contain a coin/button cell battery. If the coin/button cell battery is swallowed, it can cause severe internal burns in just 2 hours and can lead to death.

Keep new and used batteries away from children. If the battery compartment does not close securely, stop using the product and keep it away from children.

If you think batteries might have been swallowed or placed inside any part of the body, seek immediate medical attention.

## WARNING

Never place a television set in unstable or inclined locations. A television set may fall, causing serious personal injury or death. Many injuries, particularly to children, can be avoided by taking simple precautions such as;

- Using cabinets or stands recommended by the manufacturer of the television set.
- Only using furniture that can safely support the television set.
- Ensuring the television set is not overhanging the edge of the supporting furniture.
- Not placing the television set on tall furniture (for example, cupboards or bookcases) without anchoring both the furniture and the television set to a suitable support.
- Not standing the television set on cloth or other materials placed between the television and supporting furniture.
- Educating children about the dangers of climbing on furniture to reach the television set or its controls. If your existing television set is being retained and relocated, the same considerations as above should be applied.

## WALL MOUNTING WARNINGS

- Read the instructions before mounting your TV on the wall.
- The wall mount kit is optional. You can obtain from your local dealer, if not supplied with your TV.
- Do not install the TV on a ceiling or on an inclined wall.
- Use the specified wall mounting screws and other accessories.
- Tighten the wall mounting screws firmly to prevent the TV from fall. Do not over-tighten the screws.

## WARNING

Apparatus connected to the protective earthing of the building installation through the MAINS connection or through other apparatus with a connection to protective earthing – and to a television distribution system using coaxial cable, may in some circumstances create a fire hazard. Connection to a television distribution system has therefore to be provided through a device providing electrical isolation below a certain frequency range (galvanic isolator, see EN 60728-11)

## Symbols in this Instruction Book

The following symbols are used in the Instruction Book as a marker for restrictions and precautions and safety instructions. Note such information for security reasons.

### **WARNING**

If you do not pay attention to such a marked warning, it can cause serious injury or death. Note these warnings strictly, in order to ensure a safe operation.

### **CAUTION**

Such a precaution is marked, you should take up or note, to avoid injury or property damage. Note these instructions strictly, in order to ensure a safe operation.

### **IMPORTANT**

Warnings on the appliance and restrictions are displayed like this. Read this information strictly in order to operate the system correctly and avoid damage.

### **NOTE**

Information about the operation and additional explanations are marked like this. To be aware of such information is recommended to ensure that the functions can be used optimally.

## Markings on the Product

The following symbols are used **on the product** as a marker for restrictions and precautions and safety instructions. Each explanation shall be considered where the product bears related marking only. Note such information for security reasons.



**Class II Equipment:** This appliance is designed in such a way that it does not require a safety connection to electrical earth.



**Class II Equipment With Functional Earthing:** This appliance is designed in such a way that it does not require a safety connection to electrical earth, the earth connection is used for functional purposes.



**Protective Earth Connection:** The marked terminal is intended for connection of the protective earthing conductor associated with the supply wiring.



**Hazardous Live Terminal:** The marked terminal(s) is/are hazardous live under normal operating conditions.



**Caution, See Operating Instructions:** The marked area(s) contain(s) user replaceable coin or button cell batteries.



**Class 1 Laser Product:** This product contains Class 1 laser source that is safe under reasonably foreseeable conditions of operation.

The illustrations and the OSD in this operation manual are for explanation purposes and may vary slightly from the actual operations.

Technical experts are available 7 days a week

- **Simple help and advice on setting up your digital equipment (image).**
- **Guidance on connecting other devices to your television such as a DVD player, Sky, home cinema system or a games console.**
- **Order spare parts, including that lost remote control.**
- **Any other technical issues you may need assistance with.**

**Call us today: 0 345 604 0105**

Local call rates applies\*

**Lines open 9am-8pm Monday to Saturday and 10am-4pm Sunday**

\*Calls to Argos enquiry lines may attract a charge and set up fee from residential lines depending on your call plan/tariff. Mobile and other providers costs may vary, see [www.bt.com/pricing](http://www.bt.com/pricing) for details.

For Security and training purposes, telephone calls to and from customer service centres maybe recorded and monitored. Calls from Republic of Ireland will attract international call charges.

For online detailed guides and further assistance please use the link below  
<https://www.argos-support.co.uk/8043090>

## Environmental Information

This television is designed to be environment friendly. To reduce energy consumption, you can follow these steps:

If you set the **Energy Saving** to **Minimum**, **Medium**, **Maximum** or **Auto** the TV will reduce the energy consumption accordingly. If you like to set the **Backlight** to a fixed value set as **Custom** and adjust the **Backlight** (located under the **Energy Saving** setting) manually using Left or Right buttons on the remote. Set as **Off** to turn this setting off.

*Note: Available **Energy Saving** options may differ depending on the selected **Mode** in the **Picture** menu.*

The **Energy Saving** settings can be found in the **Picture** menu. Note that some picture settings will be unavailable to be changed.

If pressed Right button while **Auto** option is selected or Left button while **Custom** option is selected, "**Screen will be off in 15 seconds.**" message will be displayed on the screen. Select **Proceed** and press **OK** to turn the screen off immediately. If you don't press any button, the screen will be off in 15 seconds. Press any button on the remote or on the TV to turn the screen on again.

*Note: **Screen Off** option is not available if the Mode is set to **Game**.*

When the TV is not in use, please switch off or disconnect the TV from the mains plug. This will also reduce energy consumption.

## Features

- TV supports Ultra HD (Ultra High Definition - also known as 4K) which provides resolution of 3840 x 2160 (4K:2K). It equals 4 times the resolution of Full HD TV by doubling the pixel count of the Full HD TV both horizontally and vertically. Ultra HD contents are supported from HDMI, USB inputs and over DVB-T2 and DVB-S2 broadcasts.
- Remote controlled colour TV
- Fully integrated digital terrestrial TV (DVB-T-T2)
- HDMI inputs to connect other devices with HDMI sockets
- USB input
- OSD menu system
- Stereo sound system
- Teletext
- Headphone connection
- Automatic programming system
- Manual tuning
- Automatic power down after up to eight hours.
- Sleep timer
- Child lock
- Automatic sound mute when no transmission.

- NTSC playback
- AVL (Automatic Volume Limiting)
- PLL (Frequency Search)
- PC input
- Game Mode (Optional)
- Picture off function
- Ethernet (LAN) for Internet connectivity and service
- 802.11 a/b/g/n WIFI Support via USB dongle (not supplied)
- Audio Video Sharing

**High Dynamic Range (HDR) / Hybrid Log-Gamma (HLG):** Using this feature the TV can reproduce greater dynamic range of luminosity by capturing and then combining several different exposures. HDR/HLG promises better picture quality thanks to brighter, more realistic highlights, more realistic color and other improvements. It delivers the look that filmmakers intended to achieve, showing the hidden areas of dark shadows and sunlight with full clarity, colour and detail. HDR/HLG contents are supported via native and portal applications, HDMI, USB inputs and over DVB-S broadcasts. Set the related HDMI source input as **Enhanced** from the **Sources** option in the **Settings** menu in order to watch HDR/HLG images, if the HDR/HLG content is received through an HDMI input. The source device should also be at least HDMI 2.0a compatible in this case.

## Accessories Included

- Remote Control
- Batteries: 2 x AAA
- Instruction Book
- Quick Start Guide

## Standby Notifications

If the TV does not receive any input signal (e.g. from an aerial or HDMI source) for 3 minutes, it will go into standby. When you next switch-on, the following message will be displayed: "**TV switched to stand-by mode automatically because there was no signal for a long time.**" Press **OK** to continue.

The **Auto TV OFF** option (in the **System**>**Settings**>**More** menu) may be set to a value between 1 and 8 hours by default. If this setting is not set as **Off** and the TV has been left on and not been operated during the set time, it will switch into standby mode after the set time has expired. When you next switch-on the TV, the following message will be displayed. "**TV switched to stand-by mode automatically because no operation was made for a long time.**" Press **OK** to continue.



## TV Control Switch & Operation

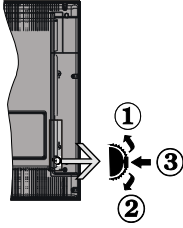

1. Up direction
2. Down direction
3. Volume / Info / Sources List selection and Standby-On switch

The Control button allows you to control the Volume / Programme / Source and Standby-On functions of the TV.

**To change volume:** Increase the volume by pushing the button up. Decrease the volume by pushing the button down.

**To change channel:** Press the middle of the button in, the information banner will appear on the screen. Scroll through the stored channels by pushing the button up or down.

**To change source:** Press the middle of the button in twice (for the second time in total), the source list will appear on the screen. Scroll through the available sources by pushing the button up or down.

**To turn the TV off:** Press the middle of the button in and hold it down for a few seconds, the TV will turn into standby mode.

**To turn on the TV:** Press the middle of the button in, the TV will turn on.

### Notes:

- If you turn the TV off, this circle starts again beginning with the volume setting.
- Main menu OSD cannot be displayed via control button.

### Operation with the Remote Control

Press the **Menu** button on your remote control to display main menu screen. Use the directional buttons to select a menu tab and press **OK** to enter. Use the directional buttons again to select or set an item. Press **Return/Back** or **Menu** button to quit a menu screen.

### Input Selection

Once you have connected external systems to your TV, you can switch to different input sources. Press the **Source** button on your remote control consecutively to select the different sources.

### Changing Channels and Volume

You can change the channel and adjust the volume by using the **Volume +/-** and **Programme +/-** buttons on the remote.

## Inserting the Batteries into the Remote

Remove the back cover to reveal the battery compartment. Insert two size **AAA** batteries. Make sure the (+) and (-) signs match (observe correct polarity). Do not mix old and new batteries. Replace only with same or equivalent type. Place the cover back on.

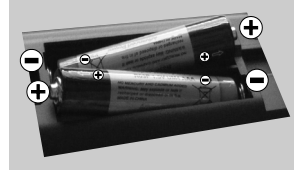

## Connect Power

**IMPORTANT:** The TV set is designed to operate on **220-240V AC, 50 Hz** socket. After unpacking, allow the TV set to reach the ambient room temperature before you connect the set to the mains. Plug the power cable to the mains socket outlet.

## Antenna Connection

Connect the aerial plug to the **AERIAL INPUT (ANT)** socket located on the rear side of the TV.

## Rear side of the TV

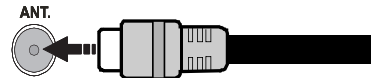

## License Notification

The terms HDMI and HDMI High-Definition Multimedia Interface, and the HDMI Logo are trademarks or registered trademarks of HDMI Licensing Administrator, Inc. in the United States and other countries.

**HDMI**<sup>™</sup>  
HIGH-DEFINITION MULTIMEDIA INTERFACE

Manufactured under license from Dolby Laboratories. Dolby, Dolby Audio and the double-D symbol are trademarks of Dolby Laboratories.

For DTS patents, see <http://patents.dts.com>. Manufactured under license from DTS Licensing Limited. DTS, the Symbol, & DTS and the Symbol together are registered trademarks, and DTS TruSurround is a trademark of DTS, Inc.® DTS, Inc. All Rights Reserved.

  
TruSurround

For DTS patents, see <http://patents.dts.com>. Manufactured under license from DTS Licensing Limited. DTS, DTS-HD, the Symbol, & DTS or DTS-HD and the Symbol together are registered trademarks of DTS, Inc.® DTS, Inc. All Rights Reserved.

  
DTS-HD

This product contains technology subject to certain intellectual property rights of Microsoft. Use or distribution of this technology outside of this product is prohibited without the appropriate license(s) from Microsoft.

Content owners use Microsoft PlayReady™ content access technology to protect their intellectual property, including copyrighted content. This device uses PlayReady technology to access PlayReady-protected content and/or WMDRM-protected content. If the device fails to properly enforce restrictions on content usage, content owners may require Microsoft to revoke the device's ability to consume PlayReady-protected content. Revocation should not affect unprotected content or content protected by other content access technologies. Content owners may require you to upgrade PlayReady to access their content. If you decline an upgrade, you will not be able to access content that requires the upgrade.

## Specification

<b>TV Broadcasting</b>	PAL BG/I/DK/LL' SECAM BG/DK
<b>Receiving Channels</b>	VHF (BAND I/III) - UHF (BAND U) - HYPERBAND
<b>Digital Reception</b>	Fully integrated digital terrestrial TV (DVB-T) (DVB-T2 compliant)
<b>Number of Preset Channels</b>	1.000
<b>Channel Indicator</b>	On Screen Display
<b>RF Aerial Input</b>	75 Ohm (unbalanced)
<b>Operating Voltage</b>	220-240V AC, 50Hz.
<b>Audio</b>	DTS TruSurround HD
<b>Audio Output Power (WRMS.) (10% THD)</b>	2 x 12
<b>Power Consumption (W)</b>	260
<b>Networked Standby (W)</b>	< 3
<b>TV Dimensions DxLxH (with foot) (mm)</b>	370 x 1684 x 1026
<b>TV Dimensions DxLxH (without foot) (mm)</b>	73 x 1684 x 967
<b>Display</b>	75"
<b>Operation temperature and operation humidity</b>	0°C up to 40°C, 85% humidity max

## Disposal information

### Instructions for waste disposal:

Packaging and packaging aids are recyclable and should principally be recycled. Packaging materials, such as foil bag, must be kept away from children. Batteries, including those which are heavy metal-free, should not be disposed of with household waste. Please dispose of used battery in an environment friendly manner. Find out about the legal regulations which apply in your area.

Don't try to recharge batteries. Danger of explosion. Replace batteries only with the same or equivalent type.

### Information for Users in European Union Countries

The mark shown on the right is in compliance with the Waste Electrical and Electronic Equipment Directive 2012/19/EU (WEEE). The mark indicates the requirement NOT to dispose the equipment including any spent or discarded batteries as unsorted municipal waste, but use the return and collection systems available. If the batteries or accumulators included with this equipment display the chemical symbol Hg, Cd, or Pb, then it means that the battery has a heavy metal content of more than 0.0005% Mercury, or more than 0.002% Cadmium or more than, 0.004% Lead.



## Wireless LAN Transmitter Specifications

Frequency Ranges	Max Output Power
2400 - 2483,5 MHz (CH1-CH13)	< 100 mW
5150 - 5250 MHz (CH36 - CH48)	< 200 mW
5250 - 5350 MHz (CH52 - CH64)	< 200 mW
5470 - 5725 MHz (CH100 - CH140)	< 200 mW

### Country Restrictions

This device is intended for home and office use in all EU countries (and other countries following the relevant EU directive) without any limitation except for the countries mentioned below.

Country	Restriction
Bulgaria	General authorization required for outdoor use and public service
France	In-door use only for 2454-2483.5 MHz
Italy	If used outside of own premises, general authorization is required
Greece	In-door use only for 5470 MHz to 5725 MHz band
Luxembourg	General authorization required for network and service supply(not for spectrum)
Norway	Radio transmission is prohibited for the geographical area within a radius of 20 km from the centre of Ny-Ålesund
Russian Federation	In-door use only

The requirements for any country may change at any time. It's recommended that user checks with local authorities for the current status of their national regulations for both 2.4 GHz and 5 GHz wireless LAN's.

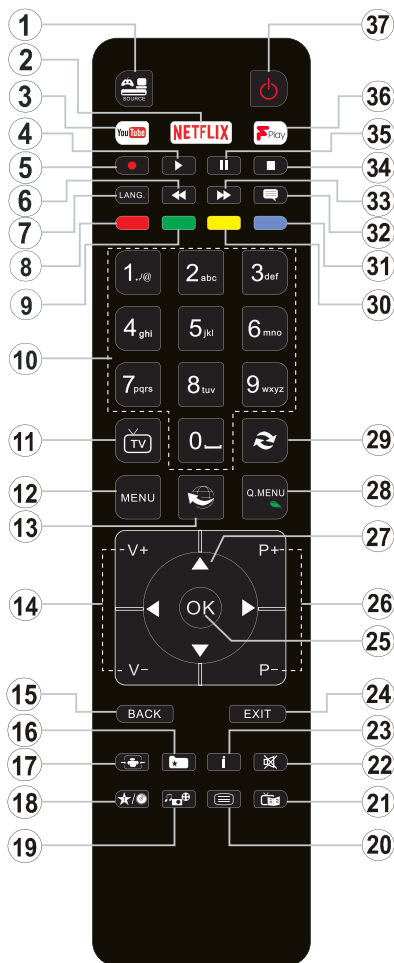



















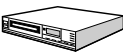





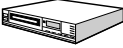



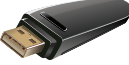
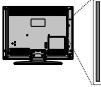

## (\*) MY BUTTON:

This button may have a default function depending on the model. However you can set a special function to this button by pressing on it for five seconds when on a desired source or channel. A confirmation message will be displayed on the screen. Now the MY BUTTON is associated with the selected function.

Note that if you perform **First Time Installation**, MY BUTTON will return to its default function.

1. **Source:** Shows all available broadcast and content sources
2. **Netflix:** Launches the Netflix application.
3. **YouTube:** Launches the YouTube application
4. **Play:** Starts to play selected media
5. **No Function**
6. **Rapid reverse:** Moves frames backwards in media such as movies
7. **Language:** Displays and changes audio/subtitle language (digital TV, where available)
8. **Red button**
9. **Green button**
10. **Numeric buttons:** Switches the channel, enters a number or a letter in the text box on the screen
11. **TV:** Switches to TV Source
12. **Menu:** Displays TV menu
13. **Internet:** Opens the portal page, where you can reach many web based applications
14. **Volume +/-**
15. **Back/Return:** Returns to previous screen, opens index page (in TXT mode)
16. **Favourites:** Displays user specified favourite channels
17. **Screen:** Changes the aspect ratio of the screen
18. **My button 1 (\*)**
19. **Media browser:** Opens the media browsing screen
20. **Text:** Displays teletext (where available), press again to superimpose the teletext over a normal broadcast picture (mix)
21. **EPG (Electronic programme guide):** Displays the electronic programme guide
22. **Mute:** Completely turns off the volume of the TV
23. **Info:** Displays information about on-screen content
24. **Exit:** Closes and exits from displayed menus or returns to previous screen
25. **OK:** Confirms user selections, holds the page (in TXT mode), views channel list (DTV mode)
26. **Programme +/-**
27. **Directional buttons:** Helps navigate menus, content etc. and displays the subpages in TXT mode when pressed Right or Left
28. **Quick Menu:** Displays a list of menus for quick access
29. **Swap:** Quickly cycles between previous and current channels or sources
30. **Yellow button**
31. **Blue button**
32. **Subtitles:** Turns subtitles on and off (where available)
33. **Rapid advance:** Moves frames forward in media such as movies
34. **Stop:** Stops the media being played
35. **Pause:** Pauses the media being played
36. **Freeview Play:** Connects to the Freeview Play platform where you can access available catch-up TV services
37. **Standby:** Switches On / Off the TV

## Connections

Connector	Type	Cables	Device
	VGA Connection (back)		
	PC/YPbPr Audio Connection (back)	 YPbPr/PC Audio Cable	
	HDMI Connection (side&back)		
	SPDIF (Optical Out) Connection (back)		
	Back AV (Audio/Video) Connection (back)	 Audio Video Cable	
	Headphone Connection (side)		
	YPbPr Video Connection (back)	 PC to YPbPr Connection Cable	
	USB Connection (side)		
	CI Connection (side)		
	Ethernet Connection (bottom)	 LAN / Ethernet Cable	
	Subwoofer Connection (back)(*)		

**NOTE:** When connecting a device via the YPbPr or Back AV inputs, you must use the connection cables to enable connection. See the illustrations on the left side. | You can use YPbPr to VGA cable to enable YPbPr signal via VGA input. | You cannot use VGA and YPbPr at the same time. | To enable PC/YPbPr audio, you will need to use the back audio inputs with a YPbPr/PC audio cable for audio connection. | When using the wall mounting kit (available from third party in the market, if not supplied), we recommend that you plug all your cables into the back of the TV before mounting on the wall. | Insert or remove the CI module only when the TV is SWITCHED OFF. You should refer to the module instruction manual for details of the settings. | The/Each USB input of your TV supports devices up to 500mA. Connecting devices that have current value above 500mA may damage your TV. | By connecting an HDMI cable to your TV, you have to use only a shielded (high grade) HDMI cable to guarantee a sufficient immunity against parasitic frequency radiation. And make sure to use a High-Speed HDMI cable that can transmit high definition signals, such as 4K contents, for trouble-free transmission.

(\*) For external subwoofer connection



If you want to connect a device to the TV, make sure that both the TV and the device are turned off before making any connection. After the connection is done, you can turn on the units and use them.

## Switching On/Off

### To Switch the TV On

Connect the power cord to a power source such as a wall socket (220-240V AC, 50 Hz).

To switch on the TV from standby mode either:

- Press the “

### To Switch the TV Off

Press the “

**To power down the TV completely, unplug the power cord from the mains socket.**

*Note: When the TV is switched into standby mode, the standby LED can blink to indicate that features such as Standby Search, Over Air Download or Timer is active. The LED can also blink when you switch on the TV from standby mode.*

## First Time Installation

When turned on for the first time, the language selection screen is displayed. Select the desired language and press **OK**.

On the next screen, set your preferences using the directional buttons.

*Note: Depending on the Country selection you may be asked to set and confirm a PIN at this point. The selected PIN cannot be 0000. You have to enter it if you are asked to enter a PIN for any menu operation later.*

### About Selecting Broadcast Type

**Digital Aerial:** If **Digital Aerial** broadcast search option is turned on, the TV will search for digital terrestrial broadcasts after other initial settings are completed.

Additionally you can set a broadcast type as your favourite one. Priority will be given to the selected broadcast type during the search process and the channels of it will be listed on the top of the **Channel List**. When finished, press **OK** to continue.

You can activate **Store Mode** option at this point. This option will configure your TV's settings for store environment and depending on the TV model being used, the supported features of it may be displayed on the top of the screen as an info banner. This option is intended only for store use. It is recommended to select **Home Mode** for home use. This option will be available in **Settings>More** menu and can be turned off/on later.

Depending on the model of your TV and the country selection **Privacy Settings** menu may appear at this point. Using this menu you can set your privacy

privileges. Highlight a feature and use Left and Right directional buttons to enable or disable. Read the related explanations displayed on the screen for each highlighted feature before making any changes. You can use **Programme +/-** buttons to scroll up and down to read the entire text. You will be able to change your preferences at any time later from the **Settings>Privacy Settings** menu. If the **Internet Connection** option is disabled **Network/Internet Settings** screen will be skipped and not displayed.

Press **OK** button on the remote control to continue and the **Network/Internet Settings** menu will be displayed, if you confirm the previously displayed message asking whether you want to do the network settings. Please refer to **Connectivity** section to configure a wired or a wireless connection. After the settings are completed press **OK** button to continue. To skip to the next step without doing anything select **No** and press the **OK** button when the message is displayed asking whether you want to do the network settings.

On the next screen you need to agree to the terms and conditions of Freeview Play to make use of the related services. Scroll the page to read the entire text using the up/down directional buttons or **Programme +/-** buttons. Highlight **Yes** and press **OK** on the remote to confirm and proceed. Highlight **No** and press **OK** to proceed without confirmation. For further requirements for Freeview Play services refer to the **Freeview Play Platform** section.

After the initial settings are completed TV will start to search for available broadcasts of the selected broadcast types.

After all the available stations are stored, scan results will be displayed. Press **OK** to continue. The **Edit Channel List** menu will be displayed next. You can edit the channel list according to your preferences or press the **Menu** button to quit and watch TV.

While the search continues a message may appear, asking whether you want to sort channels according to the LCN(\*). Select **Yes** and press **OK** to confirm.

(\* LCN is the Logical Channel Number system that organizes available broadcasts in accordance with a recognizable channel number sequence (if available).

*Note: Do not turn off the TV while initializing first time installation. Note that, some options may not be available depending on the country selection.*

## Media Playback via USB Input

*You can connect 2.5" and 3.5" inch (hdd with external power supply) external hard disk drives or USB memory stick to your TV by using the USB inputs of the TV.*

**IMPORTANT!** Back up the files on your storage devices before connecting them to the TV. Manufacturer will not be responsible for any file damage or data loss. Certain types of USB devices (e.g. MP3 Players) or USB hard disk drives/memory sticks may not be

compatible with this TV. The TV supports FAT32 and NTFS disk formatting.

Wait a little while before each plugging and unplugging as the player may still be reading files. Failure to do so may cause physical damage to the USB player and the USB device itself. Do not pull out your drive while playing a file.





You can use USB hubs with your TV's USB inputs. External power supplied USB hubs are recommended in such a case.

It is recommended to use the TV's USB input(s) directly, if you are going to connect a USB hard disk.

**Note:** When viewing image files the **Media Browser** menu can only display 1000 image files stored on the connected USB device.

### Media Browser Menu

You can play photo, music and movie files stored on a USB disk by connecting it to your TV. Connect a USB disk to one of the USB inputs located on the side of the TV. Pressing the **Menu** button while in the **Media Browser** mode will access the **Picture**, **Sound** and **Settings** menu options. Pressing the **Menu** button again will exit from this screen. You can set your **Media Browser** preferences by using the **Settings** menu.

Loop/Shuffle Mode Operation	
Start playback with the <b>Play</b> button and activate 	All files in the list will be continuously played in original order
Start playback with the <b>OK</b> button and activate 	The same file will be played continuously (repeat)
Start playback with the <b>Play</b> button and activate 	All files in the list will be played once in random order
Start playback with the <b>Play</b> button and activate  	All files in the list will be continuously played in the same random order.

### FollowMe TV (if available)

With your mobile device you can stream the current broadcast from your smart TV using the **FollowMe TV** feature. Install the appropriate Smart Center application to your mobile device. Start the application. For further information on using this feature refer to the instructions of the application you use.

**Note:** This application may not be compatible with all mobile devices. Both of the devices must be connected to the same network.

### CEC and CEC RC Passthrough

This function allows to control the CEC-enabled devices, that are connected through HDMI ports by using the remote control of the TV.

The **CEC** option in the **Settings>More** menu should be set as **Enabled** at first. Press the **Source** button and select the HDMI input of the connected CEC device from the **Sources List** menu. When new CEC source device is connected, it will be listed in source

menu with its own name instead of the connected HDMI ports name (such as DVD Player, Recorder 1 etc.).

The TV remote is automatically able to perform the main functions after the connected HDMI source has been selected.

To terminate this operation and control the TV via the remote again, press **Quick Menu** button on the remote, highlight the **CEC RC Passthrough** and set as **Off** by pressing Left or Right button. This feature can also be enabled or disabled under the **Settings>More** menu.

The TV supports also ARC (Audio Return Channel) feature. This feature is an audio link meant to replace other cables between the TV and the audio system (A/V receiver or speaker system).

When ARC is active, TV does not mute its other audio outputs automatically. So you need to decrease TV volume to zero manually, if you want to hear audio from connected audio device only (same as other optical or co-axial digital audio outputs). If you want to change connected device's volume level, you should select that device from the source list. In that case volume control keys are directed to connected audio device.

**Note:** ARC is supported only via the HDMI2 input.

### System Audio Control

Allows an Audio Amplifier/Receiver to be used with the TV. The volume can be controlled using the remote control of the TV. To activate this feature set the **Speakers** option in the **Settings>More** menu as **Amplifier**. The TV speakers will be muted and the sound of the watched source will be provided from the connected sound system.

**Note:** The audio device should support System Audio Control feature and **CEC** option should be set as **Enabled**.

## TV Menu Contents

### Picture Menu Contents

<b>Mode</b>	You can change the picture mode to suit your preference or requirements. Picture mode can be set to one of these options: <b>Cinema</b> , <b>Game</b> (optional), <b>Sports</b> , <b>Dynamic</b> and <b>Natural</b> .
<b>Contrast</b>	Adjusts the light and dark values on the screen.
<b>Brightness</b>	Adjusts the brightness values on the screen.
<b>Sharpness</b>	Sets the sharpness value for the objects displayed on the screen.
<b>Colour</b>	Sets the colour value, adjusting the colours.
<b>Energy Saving</b>	For setting the <b>Energy Saving</b> to <b>Custom</b> , <b>Minimum</b> , <b>Medium</b> , <b>Maximum</b> , <b>Auto</b> , <b>Screen Off</b> or <b>Off</b> . <b>Note:</b> Available options may differ depending on the selected <b>Mode</b> .
<b>Backlight</b>	This setting controls the backlight level. The backlight function will be inactive if the <b>Energy Saving</b> is set to an option other than <b>Custom</b> .
<b>Advanced Settings</b>	
<b>Dynamic Contrast</b>	You can change the dynamic contrast ratio to desired value.
<b>Noise Reduction</b>	If the signal is weak and the picture is noisy, use the <b>Noise Reduction</b> setting to reduce the amount of noise.
<b>Colour Temp</b>	Sets the desired colour temperature value. <b>Cool</b> , <b>Normal</b> , <b>Warm</b> and <b>Custom</b> options are available.
<b>White Point</b>	If the <b>Colour Temp</b> option is set as <b>Custom</b> , this setting will be available. Increase the 'warmth' or 'coolness' of the picture by pressing Left or Right buttons.
<b>Picture Zoom</b>	Sets the desired image size format.
<b>Film Mode</b>	Films are recorded at a different number of frames per second to normal television programmes. Turn this feature on when you are watching films to see the fast motion scenes clearly.
<b>Skin Tone</b>	Skin tone can be changed between -5 and 5.
<b>Colour Shift</b>	Adjust the desired colour tone.
<b>HDMI Full Range</b>	While watching from a HDMI source, this feature will be visible. You can use this feature to enhance blackness in the picture.
<b>PC Position</b>	
<b>Autoposition</b>	Automatically optimizes the display. Press OK to optimize.
<b>H Position</b>	This item shifts the image horizontally to the right hand side or left hand side of the screen.
<b>V Position</b>	This item shifts the image vertically towards the top or bottom of the screen.
<b>Dot Clock</b>	Dot Clock adjustments correct the interference that appear as vertical banding in dot intensive presentations like spreadsheets or paragraphs or text in smaller fonts.
<b>Phase</b>	Depending on the input source(computer etc.) you may see a hazy or noisy picture on the screen. You can use phase to get a clearer picture by trial and error.
<b>Reset</b>	Resets the picture settings to factory default settings (except <b>Game</b> mode).
<i>While in VGA (PC) mode, some items in <b>Picture</b> menu will be unavailable. Instead, VGA mode settings will be added to the <b>Picture Settings</b> while in PC mode.</i>	



Sound Menu Contents	
<b>Volume</b>	Adjusts the volume level.
<b>Equalizer</b>	Selects the equalizer mode. Custom settings can be made only when in <b>User</b> mode.
<b>Balance</b>	Adjusts whether the sound comes from the left or right speaker.
<b>Headphone</b>	Sets headphone volume. Please ensure before using headphones that the headphone volume is set to a low level, to prevent damage to your hearing.
<b>Sound Mode</b>	You can select a sound mode (If the viewed channel supports).
<b>AVL (Automatic Volume Limiting)</b>	Sets the sound to obtain fixed output level between programmes.
<b>Headphone/Lineout</b>	When you connect an external amplifier to your TV using the headphone jack, you can select this option as <b>Lineout</b> . If you have connected headphones to the TV, set this option as <b>Headphone</b> . Please ensure before using headphones that this menu item is set to <b>Headphone</b> . If it is set to <b>Lineout</b> , the output from the headphone socket will be set to maximum which could damage your hearing.
<b>Dynamic Bass</b>	Enables or disables the Dynamic Bass.
<b>DTS TruSurround HD</b>	Enables or disables the <b>DTS TruSurround HD</b> .
<b>Digital Out</b>	Sets digital out audio type.

Settings Menu Contents	
<b>Conditional Access</b>	Controls conditional access modules when available.
<b>Language</b>	You may set a different language depending on the broadcaster and the country.
<b>Privacy Settings (*)</b>	Manage your privacy privileges for smart TV related applications. Press <b>OK</b> to enter the menu and set according to your preferences.
<b>Parental</b>	Enter correct password to change parental settings. You can easily adjust <b>Menu Lock</b> , <b>Maturity Lock</b> , <b>Child Lock</b> or <b>Guidance</b> in this menu. You can also set a new <b>PIN</b> or change the <b>Default CICAM PIN</b> using the related options. <i>Note: Some menu options may not be available depending on the country selection in the <b>First Time Installation</b>. Default PIN can be set to 0000 or 1234. If you have defined the PIN(is requested depending on the country selection) during the <b>First Time Installation</b> use the PIN that you have defined.</i>
<b>Timers</b>	Sets sleep timer to turn off the TV after a certain time. Sets timers for selected programmes.
<b>Date/Time</b>	Sets date and time.
<b>Sources</b>	Enables or disables selected source options. There are <b>Regular</b> , <b>Enhanced</b> and <b>Disabled</b> options available for HDMI sources. <b>Regular</b> and <b>Enhanced</b> options are affecting the colour settings of the selected HDMI source. To be able to watch 4K or HDR/ HLG images from an HDMI source related source setting should be set as <b>Enhanced</b> if the connected device is compatible with HDMI 2.0 and subsequent versions. Set as <b>Regular</b> if the connected device is HDMI 1.4 compatible. Set accordingly or disable the related HDMI source by setting as <b>Disabled</b> .
<b>Network/Internet Settings</b>	Displays network/internet settings.
<b>Accessibility</b>	Displays accessibility options of the TV.
<b>Hard of Hearing</b>	Enables any special feature sent from the broadcaster.
<b>Audio Description</b>	A narration track will be played for the blind or visually impaired audience. Press <b>OK</b> to see all available <b>Audio Description</b> menu options. This feature is available only if the broadcaster supports it.
<b>Netflix</b>	If this feature is supported by your TV, you can view your ESN(*) number and deactivate Netflix. <i>(*) ESN number is an unique ID number for Netflix, created especially to identify your TV.</i>
<b>More</b>	Displays other setting options of the TV.
<b>Menu Timeout</b>	Changes timeout duration for menu screens.
<b>Standby LED</b>	If set as <b>Off</b> the standby LED will not light up when the TV is in standby mode.
<b>Software Upgrade</b>	Ensures that your TV has the latest firmware. Press <b>OK</b> to see the menu options.
<b>Application Version</b>	Displays current software version.
<b>Subtitle Mode</b>	This option is used to select which subtitle mode will be on the screen ( <b>DVB</b> subtitle / <b>Teletext</b> subtitle) if both is available. Default value is <b>DVB</b> subtitle. This feature is available only for the country option of Norway.
<b>Auto TV OFF</b>	Sets the desired time for the TV to automatically go into standby mode when not being operated. This option can be set from 1 to 8 hours in steps of 1 hour. You can also disable this option by setting as <b>Off</b> .
<b>Store Mode</b>	Select this mode for store display purposes. Whilst <b>Store Mode</b> is enabled, some items in the TV menu may not be available.

<b>Audio Video Sharing</b>	<b>Audio Video Sharing</b> feature allows you to share files stored on your smartphone or tablet pc. If you have a compatible smartphone or tablet pc and the appropriate software is installed, you can share/play photos on your TV. See instructions of your sharing software for more information. <b>Audio Video Sharing</b> mode will not be available with internet portal feature.
<b>Power Up Mode</b>	This setting configures the power up mode preference. <b>Last State</b> and <b>Standby</b> options are available.
<b>Virtual Remote</b>	Enable or disable the virtual remote feature.
<b>CEC</b>	With this setting you can enable and disable CEC functionality completely. Press Left or Right button to enable or disable the feature.
<b>CEC Auto Power On</b>	This function allows the connected HDMI-CEC compatible device to turn on the TV and switch to its input source automatically. Press <b>Left</b> or <b>Right</b> button to enable or disable the feature.
<b>Speakers</b>	To hear the TV audio from the connected compatible audio device set as <b>Amplifier</b> . You can use the remote control of the TV to control the volume of the audio device.
<b>Show All Cookies (*)</b>	Displays all saved cookies.
<b>Delete All Cookies (*)</b>	Deletes all saved cookies.
<b>OSS</b>	Displays Open Source Software license information.

(\*) These features may not be available depending on the model of your TV and the selected country in the First Time Installation.

<b>Installation Menu Contents</b>	
<b>Automatic channel scan (Retune)</b>	Displays automatic tuning options. <b>Digital Aerial:</b> Searches and stores aerial DVB stations.
<b>Manual channel scan</b>	This feature can be used for direct broadcast entry.
<b>Network channel scan</b>	Searches for the linked channels in the broadcast system. <b>Digital Aerial:</b> Searches for aerial network channels. <b>Digital Cable:</b> Searches for cable network channels.
<b>First time installation</b>	Deletes all stored channels and settings, resets TV to factory settings.

## General TV Operation

### Using the Channel List

The TV sorts all stored stations in the **Channel List**. You can edit this channel list, set favourites or set active stations to be listed by using the **Channel List** options. Press the **OK/TV** button to open the **Channel List**. You can filter the listed channels by pressing the **Blue** button or open the **Edit Channel List** menu by pressing the **Green** button in order to make advanced changes in the current list.

### Managing the Favourite Lists

You can create four different lists of your favourite channels. Enter the **Channel List** in the main menu or press the **Green** button while the **Channel List** is displayed on the screen in order to open the **Edit Channel List** menu. Select the desired channel on the list. You can make multiple choices by pressing the **Yellow** button. Then press the **OK** button to open the **Channel Edit Options** menu and select **Add/Remove Favourites** option. Press the **OK** button again. Set the desired list option to **On**. The selected channel/s will be added to the list. In order to remove a channel or channels from a favourite list follow the same steps and set the desired list option to **Off**.

You can use the **Filter** function in the **Edit Channel List** menu to filter the channels in the **Channel list** permanently according to your preferences. Using this **Filter** option, you can set one of your four favourite lists to be displayed everytime the **Channel list** is opened. The filtering function in the **Channel list** menu will only filter the currently displayed **Channel list** in order to find a channel and tune in to it. These changes will not remain the next time the **Channel list** is opened if you don't save them. To save the changes on the list press the **Red** button after filtering while the **Channel list** is displayed on the screen.

### Configuring Parental Settings

The **Parental Settings** menu options can be used to prohibit users from viewing of certain programmes, channels and using of menus. These settings are located in the **Settings>Parental** menu.

To display parental lock menu options, a PIN number should be entered. After coding the correct PIN number, **Parental Settings** menu will be displayed.

**Menu Lock:** This setting enables or disables access to all menus or installation menus of the TV.

**Guidance:** This setting enables or disables access some of the MHEG applications. Disabled applications can be released by entering the right PIN.

**Set PIN:** Defines a new PIN number.

**Default CICAM PIN:** This option will appear as greyed out if no CI module is inserted into the CI slot of the

TV. You can change the default PIN of the CI CAM using this option.

**Note:** *Default PIN can be set to 0000 or 1234. If you have defined the PIN (is requested depending on the country selection) during the **First Time Installation** use the PIN that you have defined.*

*Some options may not be available depending on the country selection in the **First Time Installation**.*

### Electronic Programme Guide (EPG)

Some channels send information about their broadcast schedules. Press the **Epg** button to view the **Programme Guide** menu.

There are 3 different types of schedule layouts available, **Timeline Schedule**, **List Schedule** and **Now/Next Schedule**. To switch between them follow the instructions on the bottom of the screen.

#### Timeline Schedule

**Zoom (Yellow button):** Press the **Yellow** button to see events in a wider time interval.

**Filter (Blue button):** Views filtering options.

**Highlight Genre (Subtitles button):** Displays **Highlight Genre** menu. Using this feature, you can search the programme guide database in accordance with the genre. Info available in the programme guide will be searched and results matching your criteria will be highlighted.

**Options (OK button):** Displays event options.

**Event Details (Info button):** Displays detailed information about selected programmes.

**Next/Prev Day (Programme +/- buttons):** Displays the programmes of previous or next day.

**Search (Text button):** Displays **Guide Search** menu.

**Now (Source button):** Displays current event of the highlighted channel.

#### List Schedule(\*)

*(\*) In this layout option, only the events of the highlighted channel will be listed.*

**Prev. Time Slice (Red button):** Displays the programmes of previous time slice.

**Next/Prev Day (Programme +/- buttons):** Displays the programmes of previous or next day.

**Event Details (Info button):** Displays detailed information about selected programmes.

**Filter (Text button):** Views filtering options.

**Next Time Slice (Green button):** Displays the programmes of next time slice.

**Options (OK button):** Displays event options.

#### Now/Next Schedule

**Options (OK button):** Displays event options.

**Event Details (Info button):** Displays detailed information about selected programmes.

**Filter (Blue button):** Views filtering options.

## Programme Options

Use the directional buttons to highlight a programme and press **OK** button to display **Event Options** menu. The following options are available.

**Select Channel:** Using this option, you can switch to the selected channel.

**Set Timer on Event / Delete Timer on Event:** After you have selected a programme in the EPG menu, press the **OK** button. Select **Set Timer on Event** option and press the **OK** button. You can set a timer for future programmes. To cancel an already set timer, highlight that programme and press the **OK** button. Then select **Delete Timer on Event** option. The timer will be cancelled.

**Notes:** You cannot switch to any other channel while there is an active timer on the current channel.

It is not possible to set timer for two or more individual events at the same time interval.

## Integrated Catch-Up Services

You can enjoy Freeview Play catch-up TV services that work directly through the electronic programme guide (EPG). Whilst you are on a channel use the directional buttons to scroll back in time through the timeline-based EPG. You will see contents from last few days. Available catch-up contents may change according to broadcasters and will be marked with a play icon. Highlight the content you want to play back and press the **OK** button.

Make sure that your TV is connected to your home network in order to use the catch-up services. For further information regarding this matter and other requirements for Freeview Play services refer to the **Connectivity** and **Freeview Play Platform** sections.

## Teletext Services

Press the **Text** button to enter. Press again to activate mix mode, which allows you to see the teletext page and the TV broadcast at the same time. Press once more to exit. If available, sections in the teletext pages will become colour-coded and can be selected by pressing the coloured buttons. Follow the instructions displayed on the screen.

## Digital Teletext

Press the **Text** button to view digital teletext information. Operate it with the coloured buttons, cursor buttons and the **OK** button. The operation method may differ depending on the contents of the digital teletext. Follow the instructions displayed on the digital teletext screen. When the **Text** button is pressed again, the TV returns to television broadcast.

## BBC Red Button+ (RB+)

While watching BBC channels, press the **Red** button to access Red Button+ services provided by the BBC. On the opening page you can access to BBC's main services such as BBC iPlayer, BBC News, BBC Sport and many others. There are also links to the home pages of the related applications available. Use the navigation

buttons on the TV's remote control to move through the application. Press **Exit** button to close and exit.

## Software Upgrade

Your TV is capable of finding and updating the firmware automatically via the broadcast signal or via Internet.

## Software upgrade search via user interface

On the main menu select **Settings** and then **More**. Navigate to **Software upgrade** and press the **OK** button. In **Upgrade options** menu select **Scan for upgrade** and press **OK** button to check for a new software upgrade.

If a new upgrade is found, it starts to download the upgrade. After the download is completed confirm the question asking about rebooting the TV by pressing the **OK** to continue with the reboot operation.

## 3 AM search and upgrade mode

Your TV will search for new upgrades at 3:00 o'clock if **Automatic scanning** option in the **Upgrade options** menu is set to **Enabled** and if the TV is connected to an aerial signal or to Internet. If a new software is found and downloaded successfully, it will be installed at the next power on.

**Note:** Do not unplug the power cord while led is blinking during the reboot process. If the TV fails to come on after the upgrade, unplug, wait for two minutes then plug it back in.

## Troubleshooting & Tips

### Tv will not turn on

Make sure the power cord is plugged in securely to wall outlet. Check if batteries are exhausted. Press the Power button on the TV.

### Poor picture

- Check if you have selected the correct TV system.
- Low signal level can cause picture distortion. Please check antenna access.
- Check if you have entered the correct channel frequency if you have done manual tuning.
- The picture quality may degrade when two devices are connected to the TV at the same time. In such a case, disconnect one of the devices.

### No picture

- This means your TV is not receiving any transmission. Make sure the correct source has been selected.
- Is the antenna connected properly?
- Is the antenna cable damaged?
- Are suitable plugs used to connect the antenna?
- If you are in doubt, consult your dealer.

## **No sound**

- Check if the TV is muted. Press the **Mute** button or increase the volume to check.
- Sound may be coming from only one speaker. Check the balance settings from **Sound** menu.

## **Remote control - no operation**

- The batteries may be exhausted. Replace the batteries.

## **Input sources - can not be selected**

- If you cannot select an input source, it is possible that no device is connected. If not;
- Check the AV cables and connections if you are trying to switch to the input source dedicated to the connected device.

## PC Input Typical Display Modes

The following table is an illustration of some of the typical video display modes. Your TV may not support all resolutions.

Index	Resolution	Frequency
1	640x350	85Hz
2	640x480	60Hz
3	640x480	72Hz
4	640x480	75Hz
5	800x600	56Hz
6	800x600	60Hz
7	800x600	72Hz
8	800x600	75Hz
9	1024x768	60Hz
10	1024x768	70Hz
11	1024x768	75Hz
12	1024x768	85Hz
13	1152x864	75Hz
14	1280x768	60Hz
15	1280x768	75Hz
16	1280x960	60Hz
17	1280x960	75Hz
18	1280x1024	60Hz
19	1280x1024	75Hz
20	1360x768	60Hz
21	1366x768	60Hz
22	1400x1050	59Hz
23	1400x1050	60Hz
24	1400x1050	75Hz
25	1440x900	60Hz
26	1440x900	75Hz
27	1600x1200	60Hz
28	1680x1050	59Hz
29	1680x1050	60Hz
30	1920x1080	60Hz

## AV and HDMI Signal Compatibility

Source	Supported Signals	Available
Back AV	PAL	O
	SECAM	O
	NTSC4.43	O
	NTSC3.58	O
YPbPr	480i, 480p	60Hz O
	576i, 576p	50Hz O
	720p	50Hz,60Hz O
	1080i	50Hz,60Hz O
HDMI	480i	60Hz O
	480p	60Hz O
	576i, 576p	50Hz O
	720p	50Hz,60Hz O
	1080i	50Hz,60Hz O
	1080p	24Hz, 25Hz, 30Hz, 50Hz, 60Hz O
	3840x2160p	24Hz, 25Hz, 30Hz, 50Hz, 60Hz O
	4096x2160p	24Hz, 25Hz, 30Hz, 50Hz, 60Hz O

(X: Not Available, O: Available)

In some cases a signal on the TV may not be displayed properly. The problem may be an inconsistency with standards from the source equipment (DVD, Set-top box, etc. ). If you do experience such a problem please contact your dealer and also the manufacturer of the source equipment.

## Supported Video File Formats for USB Mode

Video Codec	Resolution	Bit Rate	Container
MPEG1/2	1080Px2@30fps, 1080P@60fps	40Mbps	MPEG program stream (.DAT, .VOB, .MPG, .MPEG), MPEG transport stream (.ts, .trp, .tp), MP4 (.mp4, .mov), 3GPP (.3gpp, .3gp), AVI (.avi), MKV (.mkv), ASF (.asf)
MPEG4			MPEG program stream (.MPG, .MPEG), MP4 (.mp4, .mov), 3GPP (.3gpp, .3gp), AVI (.avi), MKV (.mkv), ASF (.asf)
XviD			MP4 (.mp4, .mov), AVI (.avi), MKV (.mkv), ASF (.asf)
Sorenson H.263			FLV (.flv), AVI (.avi), SWF(.swf)
H.263			MP4 (.mp4, .mov), 3GPP (.3gpp, .3gp), AVI (.avi), MKV (.mkv)
H.264	3840x2160@30fps, 1080P@60fps	135Mbps	FLV (.flv), MP4 (.mp4, .mov), 3GPP (.3gpp, .3gp), MPEG transport stream (.ts, .trp, .tp), ASF (.asf), AVI (.avi), MKV (.mkv)
Motion JPEG	720P@30fps	10Mbps	AVI (.avi), 3GPP (.3gpp, .3gp), MP4 (.mp4, .mov), MKV (.mkv), ASF (.asf)
VP8	1080P@30fps	20Mbps	MKV (.mkv), WebM (.webm)
HEVC/H.265	4K2K@60fps	100Mbps	MP4 (.mp4, .mov), MKV (.mkv), MPEG transport stream (.ts, .trp, .tp)
	1080P@60fps	50Mbps	MP4 (.mp4, .mov), MKV (.mkv), MPEG transport stream (.ts, .trp, .tp), 3GPP (.3gpp, .3gp)
VP9	4K2K@30fps	100Mbps	MKV (.mkv), WebM (.webm)

## Supported Picture File Formats for USB Mode

Image	Photo	Resolution (width x height)	Remark
JPEG	Base-line	15360x8640	The limit for max resolution depends on DRAM size
	Progressive	1024x768	
PNG	non-interlace	9600x6400	
	interlace	1200x800	
BMP		9600x6400	



## Supported Audio File Formats for USB Mode

Audio Codec	Sample rate	Bit Rate	Container
MPEG1/2 Layer1	16KHz ~ 48KHz	32Kbps ~ 448Kbps	MP3 (.mp3), AVI (.avi), ASF (.asf), Matroska (.mkv, .mka), MPEG transport stream (.ts, .trp, .tp), MPEG program stream (.DAT, .VOB, .MPG, .MPEG), WAV (.wav)
MPEG1/2 Layer2	16KHz ~ 48KHz	8Kbps ~ 384Kbps	MP3 (.mp3), AVI (.avi), ASF (.asf), Matroska (.mkv, .mka), MPEG transport stream (.ts, .trp, .tp), MPEG program stream (.DAT, .VOB, .MPG, .MPEG), WAV (.wav)
MPEG1/2 Layer3	16KHz ~ 48KHz	8Kbps ~ 320Kbps	MP3 (.mp3), AVI (.avi), ASF (.asf), Matroska (.mkv, .mka), 3GPP (.3gpp, .3gp), MP4 (.mp4, .mov, m4a), MPEG transport stream (.ts, .trp, .tp), MPEG program stream (.DAT, .VOB, .MPG, .MPEG), FLV (.flv), WAV (.wav), SWF (.swf)
AC3	32KHz, 44.1KHz, 48KHz	32Kbps ~ 640Kbps	AC3 (.ac3), AVI (.avi), Matroska (.mkv, .mka), 3GPP (.3gpp, .3gp), MP4 (.mp4, .mov, m4a), MPEG transport stream (.ts, .trp, .tp), MPEG program stream (.DAT, .VOB, .MPG, .MPEG)
EAC3	32KHz, 44.1KHz, 48KHz	32Kbps ~ 6 Mbps	EAC3 (.ec3), 3GPP (.3gpp, .3gp), MP4 (.mp4, .mov, m4a), MPEG transport stream (.ts, .trp, .tp), MPEG program stream (.DAT, .VOB, .MPG, .MPEG)
AAC, HEAAC	8KHz ~ 48KHz		AAC (.aac), AVI (.avi), Matroska (.mkv, .mka), 3GPP (.3gpp, .3gp), MP4 (.mp4, .mov, m4a), MPEG transport stream (.ts, .trp, .tp), MPEG program stream (.DAT, .VOB, .MPG, .MPEG), FLV (.flv), RM (.ra)
WMA	8KHz ~ 48KHz	128bps ~ 320Kbps	ASF (.wma, .asf), AVI (.avi), Matroska (.mkv, .mka)
WMA 10 Pro M0	48KHz	< 192kbps	
WMA 10 Pro M1	48KHz	< 384kbps	
WMA 10 Pro M2	96KHz	< 768kbps	
G711 A/mu-law	8KHz	64Kbps ~ 128Kbps	WAV (.wav), AVI (.avi), Matroska (.mkv, .mka), 3GPP (.3gpp, .3gp), MP4 (.mp4, .mov, m4a)
LBR (cook)	8KHz, 11.025KHz, 22.05KHz, 44.1KHz	6Kbps ~ 128Kbps	RM (.ra)
FLAC	8KHz~96KHz	< 1.6Mbps	Matroska (.mkv, .mka)

**Supported Subtitle File Formats for USB Mode**

<b>Internal Subtitles</b>		
<b>Extension</b>	<b>Container</b>	<b>Subtitle Code</b>
dat, mpg, mpeg, vob	MPG, MPEG	DVD Subtitle
ts, trp, tp	TS	DVB Subtitle
mp4	MP4	DVD Subtitle UTF-8 Plain Text
mkv	MKV	ASS SSA UTF-8 Plain Text VobSub DVD Subtitle
avi	AVI (1.0, 2.0), DMF0,1, 2	XSUB XSUB+

<b>External Subtitles</b>		
<b>Extension</b>	<b>Subtitle Parser</b>	<b>Remark</b>
.srt	Subrip	
.ssa/ .ass	SubStation Alpha	
.smi	SAMI	
.sub	SubViewer MicroDVD DVDSubtitleSystem SubIdx (VobSub)	SubViewer 1.0 & 2.0 Only
.txt	TMPlayer	

## Supported DVI Resolutions

When connecting devices to your TV's connectors by using DVI converter cable(DVI to HDMI cable - not supplied), you can refer to the following resolution information.

	56Hz	60Hz	66Hz	70Hz	72Hz	75Hz
640x480		<input checked="" type="checkbox"/>				<input checked="" type="checkbox"/>
800x600	<input checked="" type="checkbox"/>	<input checked="" type="checkbox"/>				<input checked="" type="checkbox"/>
1024x768		<input checked="" type="checkbox"/>		<input checked="" type="checkbox"/>		<input checked="" type="checkbox"/>
1280x768		<input checked="" type="checkbox"/>				<input checked="" type="checkbox"/>
1280x960		<input checked="" type="checkbox"/>				
1360x768		<input checked="" type="checkbox"/>				
1366x768		<input checked="" type="checkbox"/>				
1280x1024		<input checked="" type="checkbox"/>		<input checked="" type="checkbox"/>		<input checked="" type="checkbox"/>
1400x1050		<input checked="" type="checkbox"/>				
1600x900		<input checked="" type="checkbox"/>				
		<input checked="" type="checkbox"/>				

# Connectivity

## Wired Connectivity

### To Connect to a Wired Network

- You must have a modem/router connected to an active broadband connection.
- Connect your TV to your modem/router via an ethernet cable. There is a LAN port at the rear (back) of your TV.

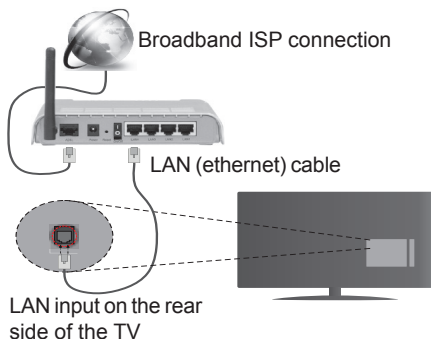

To configure wired settings please refer to the **Network/Internet Settings** section in the **Settings Menu**.

- You might be able to connect your TV to your LAN depending on your network's configuration. In such a case, use an ethernet cable to connect your TV directly to the network wall outlet.

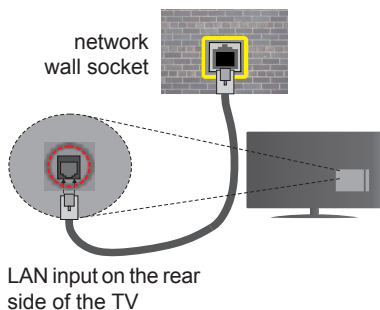

### Configuring Wired Device Settings

#### Network Type

The **Network Type** can be selected as **Wired Device**, **Wireless Device** or **Disabled**, in accordance with the active connection to the TV set. Select this as **Wired Device** if you are connecting via an ethernet cable.

#### Internet Speed Test

Highlight **Internet Speed Test** and press the **OK** button. TV will check the internet connection bandwidth and display the result when complete.

## Advanced Settings

Highlight **Advanced Settings** and press the **OK** button. On the next screen you can change the IP and DNS settings of the TV. Highlight the desired one and press Left or Right button to change the setting from **Automatic** to **Manual**. Now you can enter the **Manual IP** and / or **Manual DNS** values. Select the related item in the drop down menu and enter the new values using the numeric buttons of the remote. Press the **OK** button to save settings when complete.

## Wireless Connectivity

### To Connect to a Wireless Network

The TV cannot connect to the networks with a hidden SSID. To make your modem's SSID visible, you should change your SSID settings via the modem's software.

**To Connect to a wireless LAN, you should perform the following steps:**

38. To configure your wireless settings please refer to the **Network/Internet Settings** section in the **Settings Menu**.



A Wireless-N router (IEEE 802.11a/b/g/n) with simultaneous 2.4 and 5 GHz bands is designed to increase bandwidth. These are optimized for smoother and faster HD video streaming, file transfers and wireless gaming.

- The frequency and channel differ depending on the area.
- The transmission speed differs depending on the distance and number of obstructions between the transmission products, the configuration of these products, the radio wave conditions, the line traffic and the products that you use. The transmission may also be cut off or may get disconnected depending on the radio wave conditions, DECT phones or any other WiFi 11b appliances. The standard values of the transmission speed are the theoretical maximum values for the wireless standards. They are not the actual speeds of data transmission.
- The location where the transmission is most effective differs depending on the usage environment.

- The Wireless feature of the TV supports 802.11 a,b,g & n type modems. It is highly recommended that you should use the IEEE 802.11n communication protocol in order to avoid any possible problems while watching videos.
- You must change your modem's SSID when there are any other modems around with the same SSID. You can encounter connection problems otherwise. Use a wired connection if you experience problems with a wireless connection.

## Configuring Wireless Device Settings

Open the **Network/Internet Settings** menu and select **Network Type** as **Wireless Device** to start connection process.

The TV will scan the wireless networks automatically. A list of available networks will be displayed. Please select your desired network from the list.

**Note:** If the modem supports N mode, you should set N mode settings.

If the selected network is protected with a password, please enter the correct key by using the virtual keyboard. You can use this keyboard via the directional buttons and the **OK** button on the remote control.

Wait until the IP address is shown on the screen.

This means that the connection is now established. To disconnect from a wireless network, highlight **Network Type** and press Left or Right buttons to set as **Disabled**.

Highlight **Internet Speed Test** and press the **OK** button to check your internet connection speed. Highlight **Advanced Settings** and press the **OK** button to open the advanced setting menu. Use directional and numeric buttons to set. Press the **OK** button to save settings when complete.

## Other Information

The status of the connection will be displayed as **Connected** or **Not Connected** and the current IP address, if a connection is established.

## Connecting to your mobile device via WiFi

- If your mobile device has WiFi feature, you can connect it to your TV via a router, in order to access the content in your device. For this, your mobile device must have an appropriate sharing software.
- Connect to your router following the steps stated above in the **Wireless Connectivity** section.
- Afterwards, engage your mobile device with the router and then activate the sharing software on your mobile device. Then, select files that you want to share with your TV.
- If the connection is established correctly, you will be able to access the shared files from your mobile device via the **Media Browser** of your TV.

- Enter the **Media Browser** menu and the playback device selection OSD will be displayed. Select your mobile device and press the **OK** button to continue.
- If available, you can download a virtual remote controller application from the server of your mobile device application provider.

 **Note:** This feature may not be supported on all mobile devices.

## Wake ON

Wake-on-LAN (WoL) and Wake-on-Wireless LAN (WoWLAN) are standards that allow a device to be turned on or woken up by a network message. The message is sent to the device by a program executed on a remote device connected to the same local area network, such as a smartphone.

Your TV is WoL and WoWLAN compatible. To enable this feature set the **Wake On** option in the **Network/Internet Settings** menu as **On**. It is necessary that both the device, from which the network message will be sent to the TV, and the TV are connected to the same network. Wake On feature is only supported for Android OS devices and can only be used via YouTube and Netflix applications.

In order to use this feature the TV and the remote device should be connected at least once while the TV is on. If the TV is powered off, the connection should be reestablished, the next time it is switched on. Otherwise this feature will be unavailable. This does not apply, when the TV is switched into the standby mode.

## Wireless Display

Wireless Display is a standard for streaming video and sound content by Wi-Fi Alliance. This feature provides the ability to use your TV as wireless display device.

## Using with mobile devices

There are different standards which enable sharing of screens including graphical, video and audio content between your mobile device and TV.

Plug the wireless USB dongle to TV first, if the TV doesn't have internal WiFi feature.

Then press the **Source** button on the remote and switch to **Wireless Display** source.

A screen appears stating that the TV is ready for connection.

Open the sharing application on your mobile device. These applications are named differently for each brand, please refer to the instruction manual of your mobile device for detailed information.

Scan for devices. After you select your TV and connect, the screen of your device will be displayed on your TV.

**Note:** This feature can be used only if the mobile device supports this feature. Scanning and connecting processes

differ according to the programme you use. Android based mobile devices should have the software version V4.2.2 and above.

## Connectivity Troubleshooting

### Wireless Network Not Available

- Ensure that any firewalls of your network allow the TV wireless connection.
- Try searching for wireless networks again, using the **Network/Internet Settings** menu screen.

If the wireless network does not function properly, try using the wired network in your home. Refer to the **Wired Connectivity** section for more information on the process.

If the TV does not function using the wired connection, check the modem (router). If the router does not have a problem, check the internet connection of your modem.

### Connection is Slow

See the instruction book of your wireless modem to get information on the internal service area, connection speed, signal quality and other settings. You need to have a high speed connection for your modem.

### Disruption during playback or slow reactions

You could try the following in such a case:

Keep at least three meters distance from microwave ovens, mobile telephones, bluetooth devices or any other Wi-Fi compatible devices. Try changing the active channel on the WLAN router.

### Internet Connection Not Available / Audio Video Sharing Not Working

If the MAC address (a unique identifier number) of your PC or modem has been permanently registered, it is possible that your TV might not connect to the internet. In such a case, the MAC address is authenticated each time when you connect to the internet. This is a precaution against unauthorized access. Since your TV has its own MAC address, your internet service provider cannot validate the MAC address of your TV. For this reason, your TV cannot connect to the internet. Contact your internet service provider and request information on how to connect a different device, such as your TV, to the internet.

It is also possible that the connection may not be available due to a firewall problem. If you think this causes your problem, contact your internet service provider. A firewall might be the reason of a connectivity and discovery problem while using the TV in Audio Video Sharing mode or while browsing via Audio Video Sharing feature.

### Invalid Domain

Ensure that you have already logged on to your PC with an authorized username/password and also

ensure that your domain is active, prior to sharing any files in your media server program on your PC. If the domain is invalid, this might cause problems while browsing files in Audio Video Sharing mode.

## Using Audio Video Sharing Network Service

Audio Video Sharing feature uses a standard that eases the viewing process of digital electronics and makes them more convenient to use on a home network.

This standard allows you to view and play photos, music and videos stored in the media server connected to your home network.

### 1. Server Software Installation

The Audio Video Sharing feature cannot be used if the server programme is not installed onto your PC or if the required media server software is not installed onto the companion device. Please prepare your PC with a proper server programme.

### 2. Connect to a Wired or Wireless Network

See the **Wired/Wireless Connectivity** chapters for detailed configuration information.

### 3. Play Shared Files via Media Browser

Select **Media Browser** by using the **directional** buttons from the main menu and press **OK**. The media browser will then be displayed.

## Audio Video Sharing

Select the desired media type on the main media browser menu and press **OK**. If sharing configurations are set properly, **Device Selection** screen will be displayed after selecting the desired media type. If available networks are found, they will be listed on this screen. Select media server or network that you want to connect to using the Up or Down buttons and press **OK**. If you want to refresh the device list, press the **Green** button. You can press **Menu** to exit.

If you select the media type as **Videos** and choose a device from the selection menu. Then select the folder with video files in it on the next screen and all the available video files will be listed.

To play other media types from this screen, you can go back to main **Media Browser** screen and select the media type as desired and then perform the network selection again. Or press the **Blue** button to switch to next media type quickly without changing the network. Refer to the **Media Browser** menu section for further information on file playback.

If a problem occurs with the network, please switch your television off at the wall socket and back on again. Trick mode and jump are not supported with the Audio Video Sharing feature.

PC/HDD/Media Player or any other devices that are compatible should be used with a wired connection for higher playback quality.

Use a LAN connection for quicker file sharing between other devices like computers.

**Note:** There may be some PC's which may not be able to utilize the Audio Video Sharing feature due to administrator and security settings (such as business PC's).

## Internet Portal

**HINT:** A broadband internet connection is required for high quality viewing. For 4K video streaming, a minimum 25Mb/s internet connection speed is required – For an example of the requirements for streaming 4K content you may find more information on the Netflix website (<https://help.netflix.com/en/node/13444>). When you start to stream video content via the internet the quality of your connection will be analysed and the full HD or 4K quality may take a short time to be realised, or in the event of a slow connection not be possible. You should check your internet capabilities with your internet provider if you are at all unsure. You must set the country option accordingly in the **First Time Installation** for proper operation of the internet portal.

Portal feature adds your TV a feature that allows you to connect a server on the Internet and view the content provided by this server over your Internet connection. Portal feature allows you to view the music, video, clip or web content with defined short-cuts. Whether you can view this content without interruption depends on the connection speed provided by your internet service provider.

Press the **Internet** button on your remote control to open internet portal page. You will see icons of the available applications and services on the portal screen. Use the directional buttons on your remote to select the desired one. You may view the desired content by pressing **OK** after selecting. Press **Back/Return** button to return back to the previous screen.

Moreover, you can access some features using the short-cut feature defined for the coloured or numeric buttons of your remote.

Press the **Exit** button to quit the Internet portal mode.

### PIP Window (depending on portal service)

Current source content will be displayed in the PIP window, if you switch to portal mode while on any active source.

If you switch to portal mode while watching TV channels, current programme will be displayed in the PIP window. You can change channels using **Programme +/-** buttons.

#### Notes:

*Possible application dependent problems may be caused by the content service provider.*

*Portal service content and the interface may be changed at any time without prior notice.*

*Third party internet services may change, be discontinued or restricted at any time.*

## iPlayer Application

You can access BBC iPlayer using your TV. Select BBC iPlayer application among the portal options.

Press the **OK** button on your remote control to start the BBC iPlayer application.

**Note:** Broadband internet connection (minimum 2mbps) is required for high quality viewing.

### Playing a Programme via iPlayer

Select a programme and press **OK** button. The programme playback will begin.

You can press the **Pause** button to pause playback. Press the **Play** button to resume the playback.

Use the **Stop** button to stop the playback.

Press the **Exit** button to exit iPlayer. Press the **Return/Back** button for going back to the previous screen.

**Note:** "Episode is unavailable" message may be displayed on the screen if a problem occurs during the playback.

### Searching a Programme

Highlight the **Search** tab using the navigation buttons and press the **OK** button. Use the virtual keyboard to type the letters. Select letters and press the **OK** button. The results will be listed below. Highlight the desired one and wait until the related videos appear. Select one among the videos using the directional buttons and press the **OK** button to start the playback.

**Note:** There are also some other BBC applications such as Sport and News available on the portal.

## Freeview Play Platform

Freeview Play platform provides catch-up TV and On Demand services. Simply press the **Freeview Play** button on your remote control to connect to the Freeview Play platform.

The Freeview Play platform can also be accessed from the main menu or internet portal. Press **Menu** button and select **Internet**. Then highlight **Freeview Play** and press the **OK** button. Or open the internet portal of the TV and select the **Freeview Play** among available applications. Then press the **OK** button.

You will have to agree to the terms and conditions for Freeview Play services first if you did not agree them during the **First Time Installation**. Highlight **Yes** and press **OK** on the remote to confirm and proceed.

Integrated TV Player applications will be displayed. Select one and press the **OK** button. Then select a content that you want to play back and press the **OK** button to watch.

Catch-up contents can also be accessed and played back directly from the TV Guide. Refer to the section **Electronic Programme Guide (EPG)** for more information.

### Requirements

The Freeview Play services may only be used if the following requirements are fulfilled:

- Connecting the TV to the internet. A minimum broadband speed of 2Mbps is required for proper operation of catch up and on demand services.
- Agreeing to the terms and conditions of Freeview Play

**Note:** Freeview Play platform usage will count towards any monthly broadband data allowance. Only selected channels provide 7-day catch up.

### Integrated Catch-Up Services

**Note:** Before connecting to the Freeview Play platform, make sure that you follow the steps below, otherwise you will not be able to access the Freeview Play platform:

- Connect aerial to the back of TV and carry out digital channel scan
- Connect TV to the internet (via WiFi or Ethernet)
- Accept the T&Cs to enable Freeview Play services
- A minimum broadband speed of 2Mbps is required to watch catch up and on demand services

This will count towards any monthly broadband data allowance. Only selected channels provide 7-day catch up.

Without the Aerial and internet connection you will not be able to access the Freeview Play platform.

### Accessing Freeview Play catch-up TV services

#### 1. Freeview Play via the Electronic Programme Guide (EPG)

Simply scroll backwards in your programme guide to access Freeview Play. Available catch-up content will be marked with a Play icon. Highlight the content and press the OK button and select playback option.

**Note:** The content available on EPG is driven by TV channels themselves and will only display if the channel content is available. When you select a programme, Freeview Play will directly launch the catch up service. If you wish to watch Demand 5 on Freeview Play, please use the other options listed below to access the catch up service.

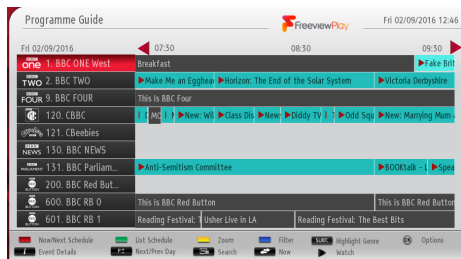

#### 2. Freeview Play via the 'FPlay button'

Click Freeview Play button on your remote control.

This will bring up the Freeview Play portal, where you can choose the channel and programme to watch with ease.



#### 3. Freeview Play via the TV's Smart Portal

Bring up the Smart Portal on your TV, Freeview Play will be one of the applications displayed on the first page. Once the Freeview play app is selected it will direct you to the same Freeview play portal seen above, where you can choose what programme you'd like to watch.

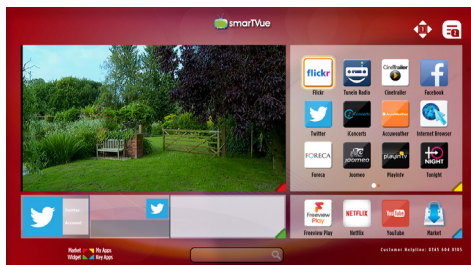

#### Internet Browser

To use the internet browser, enter the portal first. Then launch the **Internet** application on the portal.

(\*) The appearance of the internet browser logo may change

In the initial screen of the browser, the thumbnails of the predefined (if any) links to web sites available will be displayed as **Speed Dial** options along with the **Edit Speed Dial** and the **Add to Speed Dial** options.

To navigate the web browser, use the directional buttons on the remote or a connected mouse. To see the browser options bar, move the cursor to the top of the page or press the **Back/Return** button. **History**, **Tabs** and **Bookmarks** options and the browser bar which contains previous/next buttons, the refresh button, the address/search bar, the **Speed Dial** and the **Opera** buttons are available.

To add a desired website to the **Speed Dial** list for quick access, move the cursor to the top of the page or press the **Back/Return** button. The browser bar will appear. Highlight the **Speed Dial** button and press the **OK** button. Then select **Add to Speed Dial** option and press the **OK** button. Fill in the blanks for



**Name** and **Address**, highlight **OK** and press the **OK** button to add. Whilst you are on the site you wish to add to the **Speed Dial** list, highlight the **Opera- O** button and press the **OK** button. Then highlight **Add to Speed Dial** option in the submenu and press the **OK** button again. **Name** and **Address** will be filled automatically according to the site you are visiting. Highlight **OK** and press the **OK** button to add.

You can also use the **Opera** menu options to manage the browser. Highlight the **Opera- O** button and press the **OK** button to see available page specific and general options.

There are various ways to search or visit websites using the web browser.

Enter the address of a website(URL) into the search/address bar and highlight the **Submit** button on the virtual keyboard and press the **OK** button to visit the site.

Enter keyword/s into the search/address bar and highlight the **Submit** button on the virtual keyboard and press the **OK** button to start a search for the related websites.

Highlight a Speed Dial thumbnail and press the **OK** button to visit the related website.

Your TV is compatible with USB mice. Plug your mouse or wireless mouse adaptor into the USB input of your TV for easier and quicker navigation.

Some web pages include flash content. These are not supported by the browser.

Your TV does not support any download processes from the internet via the browser.

All sites on the internet might not be supported. According to the site; content problems may occur. In some circumstances video contents might not be able to be played.

### Smart Center

Smart Center is a mobile application running on iOS and Android platforms. With your tablet or phone, you can easily stream your favourite live shows and programmes from your smart TV. Also; you can launch your portal applications, use your tablet as a remote control for your TV and share media files.

**Note:** Being able to use all functions of this application depends on the features of your TV.

### Getting Started

To use Smart Center features, connections have to be done properly. To get connected to your network wirelessly, plug in the Wi-Fi dongle to one of the USB ports if your TV doesn't have internal wifi feature. To be able to use internet based features, your modem/router must be connected to the internet.

**IMPORTANT:** Make sure the TV and mobile device are connected to the same network.

For media sharing feature **Audio Video Sharing** option should be enabled(if available). Press the **Menu** button on the remote, select **Settings>More** menu and press **OK**. Highlight **Audio Video Sharing** and change as **Enabled**. Your TV is ready to connect to your mobile device now.

Install the **Smart Center** application onto your mobile device.

Start the smart center application. If all connections are configured properly, you will see your TV's name on your mobile device. If your TV's name doesn't appear on the list, wait a while and tap on the **Refresh** widget. Select your TV from the list.

### Mobile Device screen

On the main screen you can find tabs to access various features.

The application retrieves actual channel list from TV first when it starts.

**MY CHANNELS:** The programmes of first four channels from the channel list retrieved from the TV are shown. You can change the listed channels. Press on the channel thumbnail and hold. A list of channels will be displayed and you can choose your desired channel to be replaced.

**TV:** You can watch content through the TV tab. In this mode you can navigate through the channel list retrieved from your TV and click on thumbnails to view the detail pages.

**RECORDINGS:** You can view your active recordings(if available) and reminders through this tab. To delete any item, simply press on the delete icon found on each row.

**EPG:** You can view the broadcast schedules of selected channel lists through this tab. You can also navigate through channels by pressing on the selected channel on the EPG grid. Please note that updating / refreshing the EPG information may take a while depending on your network and web service quality.

**Note:** Internet connection is required for WEB based EPG informations.

**PORTAL:** This tab displays the Portal applications in scrollable view. Unless **FollowMeTV** (if available) is active, the selected application will be displayed on your TV screen.

**Note:** Internet connection is required. This tab is enabled if a portal page is in use.

**SETTINGS:** Configure the application to your liking. You can change;

**Auto-lock (Only in IOS):** The screen of the device automatically turns off after a certain amount of time. Default is off, which means the screen will always stay on.

**Auto-enable FollowMeTV:** FollowMeTV function (if available) will start automatically when this setting is enabled. Default is disabled.

**Auto-connection to TV:** When enabled, your mobile device will automatically connect to last connected TV and skips the TV search screen.

**Change TV (Only in IOS):** Shows the currently connected TV. You can press on this setting to go to the “TV search” screen and change to a different TV.

**Edit custom channel list:** You can edit your custom channel list using this setting.

**Choose channel list source:** You can choose the channel list source to be used in the application. The options are “TV List” and “Custom List”. Additionally you can activate “Remember my choice” option to set the selected channel list source as a constant choice. In this case if the selected source is available it will be used in the application.

**Version No:** Displays the current version of the application.

## Detail Page

To open detail page tap on a programme. On the detail page screen you can get detailed information of the programmes you select. There are “Details”, “Cast&Crew” and “Videos” tabs to find on this page.

**DETAILS:** This tab provides summary and information about the selected programme. Also there are links to facebook and twitter pages of the programme selected.

**CAST&CREW:** Shows all the people contributed to the current programme.

**VIDEOS:** Provides videos on Youtube related to the selected programme.

**Note:** For some functions an internet connection may be required.

## FollowMe TV Feature (if available)

Tap on the **FOLLOW ME TV** widget located at the bottom left of the screen of your mobile device to change the layout for **FollowMe TV** feature.

Tap the play icon to start streaming of the content from the TV to your mobile device. Available if your device is in your routers operation range.

## Mirror Mode

This mode of FollowMe TV feature is enabled by default and allows streaming the content from any other selected TV sources and Media Browser.

### Notes:

Note that only digital(DVB-T/C/S) SD and HD channels are supported.

Multilanguage audio support and subtitle on/off features are not functional.

The streaming performance may change depending on the quality of your connection.

## Media Share Page

To access the **Media Share** widget tap on the **Up-arrow** on the bottom left side of the screen.

If the Media Share widget is pressed, a screen is displayed where you can select the media file type to share with your TV.

**Note:** Not all image file formats are supported. This function will not work if Audio Video Sharing feature is not supported.

## Portal Launcher

To access the **Portal Launcher** widget tap on the **Up-arrow** on the bottom left side of the screen.

You can access the portal page by tapping on the **Portal Launcher** widget.

**Note:** Internet connection is required. This function will not work if a portal page is not in use.

## Smart Remote Feature

You can use your mobile device as a remote control for your TV once it has connected to the TV. To use smart remote's full features tap on the **Up-arrow** on the bottom left side of the screen.

## Voice Recognition

You can tap on the **Microphone** widget and manage your application, giving voice commands such as “Portal!”, “Volume Up/Down!”, “Programme Up/Down!”.

**Note:** This feature is only for android based devices available.

## Keyboard Page

The keyboard page can be opened in two ways; by pressing the **Keyboard** widget on the application screen or automatically by receiving a command from the TV.

## Requirements

1. Smart TV
2. Network connection
3. Mobile Device based on Android or iOS platform (Android OS 4.0 or higher; IOS 6 or higher version)
4. Smart Center app.(to be found on online application stores based on Android and iOS platforms)
5. Router modem
6. USB storage device in FAT32 format (required for PVR feature, if available)

### Notes:

For Android devices, Normal(mdpi), Large(hdpi) and Extra Large(xhdpi) screen sizes are supported. Devices with 3” or smaller screen sizes are not supported.

For iOS devices, all screen sizes are supported.

User interface of the Smart Center application is subject to change according to version installed on your device.

### **DVB-T functionality information**

This DVB receiver is only suitable for use in the country which it was designed to be used in.

Although this DVB receiver conforms to the latest DVB specifications at the time of manufacture, we cannot guarantee compatibility with future DVB transmissions due to changes that may be implemented in broadcast signals and technologies.

Some digital television functions may not be available in all countries.

We continually strive to improve our products; therefore, specifications may change without prior notice.

For advice on where to purchase accessories, please contact the store where you purchased your equipment.

### **Internet Portal functionality information**

The content and services available through the SmarTVue portal are provided by third-party providers and may be altered, suspended or discontinued at any time without notice.

Hitachi is not responsible for any of the content or services and does not warrant the availability of or access to such content or services.

For information on a particular service or on any content, please visit the service/content provider's website. If you have any questions concerning, or problems with, any content or services then please contact the relevant service/content provider directly. Hitachi is not responsible for providing customer service in relation to content or services and accepts no liability in this regard.



## Product Guarantee

This product is guaranteed against manufacturing defects for a period of



This product is guaranteed for twelve months from the date of original purchase. Any defect that arises due to faulty materials or workmanship will either be replaced, refunded or repaired free of charge where possible during this period by the dealer from whom you purchased the unit.

The guarantee is subject to the following provisions:

- The guarantee does not cover accidental damage, misuse, cabinet parts, knobs or consumable items.
- The product must be correctly installed and operated in accordance with the instructions contained in this manual.
- It must be used solely for domestic purpose.
- The guarantee will be rendered invalidated if the product is re-sold or has been damaged by inexpert repair.
- Specifications are subject to change without notice.
- The manufacturer disclaims any liability for the incidental or consequential damages.
- The guarantee is in addition to, and does not diminish your statutory or legal rights.
- In the event of a problem with the product within the guarantee period call the **Customer Helpline: 0345 604 0105**

Guarantor: Argos Ltd  
489 - 499 Avebury Boulevard  
Central Milton Keynes  
MK9 2NW

For online detailed guides and further assistance please use the link below  
<https://www.argos-support.co.uk/8043090>

## Product fiche

### Commercial Brand: HITACHI

Product No.	10113646
Model No.	75HL16T64U
Energy efficiency class	A+
Visible screen size (diagonal,approx.) (inch/cm)	75 inches /190 cm
On mode average power consumption (Watt)	160 W
Annual energy consumption (kWh/annum)	233 kWh
Standby power consumption (Watt)	0,5 W
Off mode power consumption (Watt)	0 W
Display resolution (px)	3840 x 2160

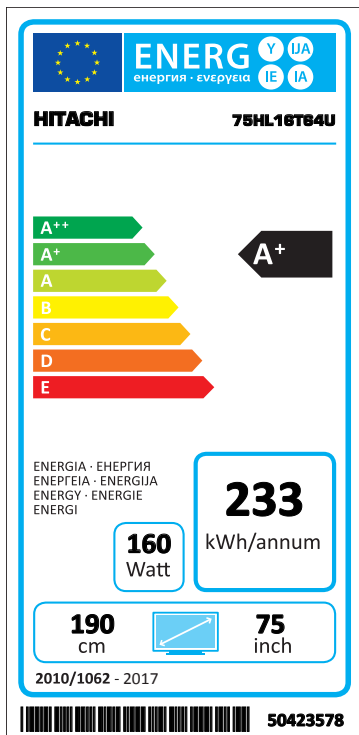

Standby Power Consumption (approx.)	0,5 W
Screen Resolution	3840 x 2160

*Hereby, HITACHI Europe Ltd., declares that the radio equipment type TV is in compliance with Directive 2014/53/EU. The full text of the EU declaration of conformity is available at the following internet address: <https://estadoc.hitachi.eu/estadoc/index.htm>  
Hitachi Europe Ltd. Whitebrook Park, Lower Cookham Road, Maidenhead, Berkshire.  
SL6 8YA. UK*

## Unboxing, Carrying the TV and Installing the Stands

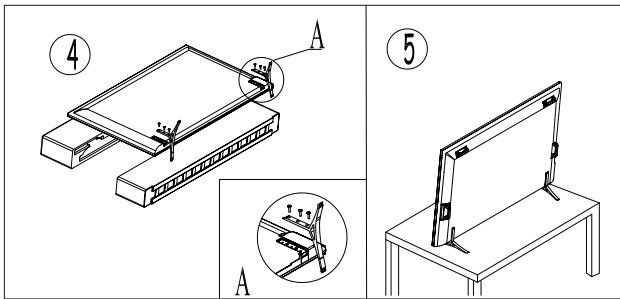
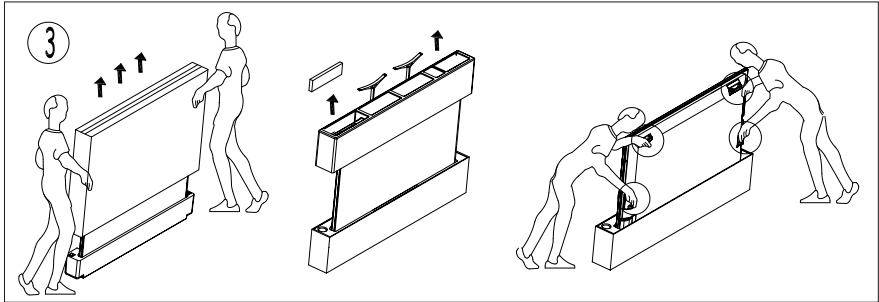
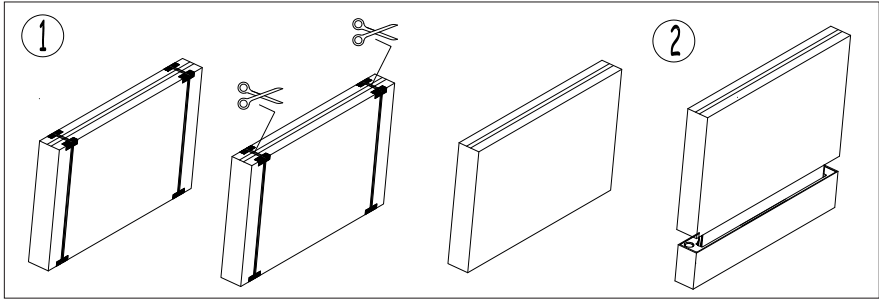

## Removing the Carry Handles

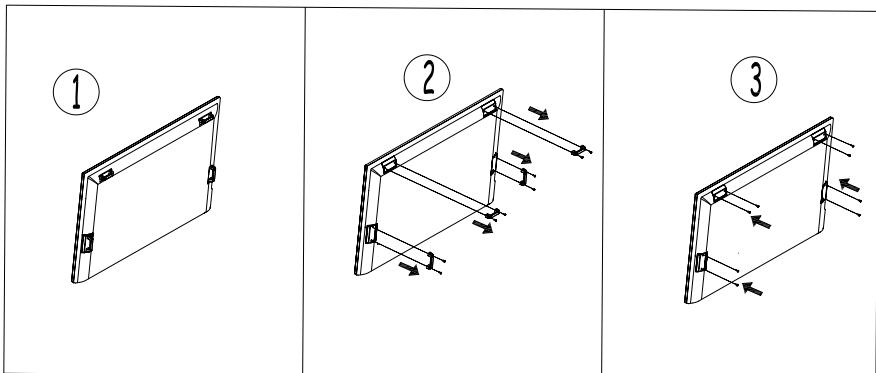

VESA WALL MOUNT MEASUREMENTS			
<b>A</b>			
<b>B</b>	<b>Hole Pattern Sizes (mm)</b>	<b>W</b>	<b>H</b>
		600	400
<b>C</b>	<b>Screw Sizes</b>		
<b>D</b>	<b>Length (X)</b>	min. (mm)	15
		max. (mm)	20
<b>E</b>	<b>Thread (Y)</b>	M8	

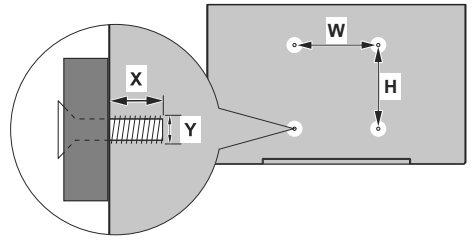

	A	B	C	D	E
<b>English</b>	VESA WALL MOUNT MEASUREMENTS	Hole Pattern Sizes (mm)	Screw Sizes	Length (X)	Thread (Y)
<b>Deutsch</b>	MASSANGABEN FÜR VESA-WANDMONTAGE	Lochmustergrößen (mm)	Schraubengrößen	Länge (X)	Gewinde (Y)
<b>Français</b>	DIMENSIONS DU SUPPORT DE FIXATION MURALE VESA	Dimensions des modèles de trous de montage (mm)	Dimensions des vis	Longueur (X)	Filetage (Y)
<b>Italiano</b>	Misurazioni installazione a parete VESA	Dimensioni schema foro (mm)	Dimensioni vite	Lunghezza (X)	Filettatura (Y)
<b>Português</b>	MEDIÇÕES DE MONTAGEM MURAL VESA	Dimensões do molde de furação (mm)	Tamanhos do parafuso	Comprimento (X)	Rosca (Y)
<b>Español</b>	MEDIDAS DEL MONTAJE DE PARED VESA	Tamaños de patrón para agujero (mm)	Tamaños de tornillo	Longitud (X)	Rosca (Y)
<b>Türkçe</b>	VESA DUVARA MONTAJ APARATI ÖLÇÜLERİ	Açılacak Delik Ölçüleri (mm)	Vida Ölçüleri	Uzunluk (X)	Yüzey (Y)
<b>Ελληνικ</b>	ΔΙΑΤΑΞΕΙΣ ΒΑΣΗΣ ΤΟΙΧΟΥ VESA	Μεγέθη οχημάτων οτάν (mm)	Μεγέθη βιδών	Μήκος (X)	Στερέωση (Y)
<b>Polski</b>	WYMIARY DO MONTAŻU NAŚCIENNEGO VESA	Rozmiary szablonu otworów (mm)	Rozmiary wkrętów	Długość (mm)	Gwint (Y)
<b>Čeština</b>	ROZMĚRY DRŽÁKU NA ZĚD VESA	Rozměry velikosti děr (mm)	Rozměry šroubů	Délka (X)	Závit (Y)
<b>Magyar</b>	VESA FALI TARTÓ MÉRLETEK	Lyukak méretének nagysága (mm)	Csavar méret	Hossz (X)	Menet (Y)
<b>Română</b>	MĂSURĂTORI SUPTOR PERETE VESA	Dimensiuni tipar gaură (mm)	Dimensiuni suruburi	lungime (X)	Filet (Y)
<b>Svenska</b>	VESA VÄGGMONTERINGSMÅTT	Hålmonsterstorlekar (mm)	Skruvstorlekar	Längd (X)	Tråd (Y)
<b>Nederlands</b>	VESA WANDMONTAGE METINGEN	Grootte booropening (mm)	Schroefgrootte	Lengte (X)	Draad (Y)
<b>Suomi</b>	VESA SEINÄASENNUKSEN MITAT	Reikäkuivion koot (mm)	Ruuvinkoot	Pituus (X)	Kierre (Y)
<b>Norsk</b>	VESA VEGGMONTERINGSMÅL	Hullmønster størrelser (mm)	Skruestørrelser	Lengde (X)	Tråd (Y)
<b>Dansk</b>	VESA VÆGGMONTERINGS-MÅL	Hullmønster-størrelser (mm)	Skruestørrelser	Længde(X)	Tråd (Y)
<b>Русский</b>	РАЗМЕРЫ НАСТЕННОГО КРЕПЛЕНИЯ VESA	Размеры системы отверстий	Размеры винтов	Длина(X)	Резьба (Y)
<b>Българска</b>	РАЗМЕРИ НАСТЕННАТА МАЛАННАНА VESA	Размери системи отвори	Размери винтове	Дължина (X)	Резба (Y)
<b>македонски</b>	МЕРКИ ЗА МОНТИРАЊЕ НА СИД ЗА „VESA“	Шема на големини на дупката (mm)	Големина на шрафот	Должина (X)	Навој (Y)
<b>український</b>	РОЗМІРИ НАСТІННОГО КРЕПЛЕННЯ VESA	Відстань між кріпильними отворами, мм	Розміри гвинтів	Довжина (X)	Діаметр різьби (Y)
<b>Srpski</b>	DIMENZIJE VESA ZIDNOG NOSAČA	Dimenzije šablona za bušenje	Dimenzije zavrtanje	Dužina (X)	Navoj (Y)
<b>Slovenčina</b>	ROZMERY DRŽAKA NA STENU VESA	Rozměry velikosti děr (mm)	Rozměry škrutiek	Dĺžka (X)	Závit (Y)
<b>Slovensčina</b>	MERE STENSKEGA NOSILCA VESA	Velikosti vzorca luknji (mm)	Velikosti vijakov	Dolžina (X)	Navoj (Y)
<b>Hrvatski</b>	VESA MIERE ZIDNOG DRŽAČA	Većičine uzorka otvora (mm)	Većičine vijaka	Dužina (X)	Navoj (Y)
<b>Bosanski</b>	DIMENZIJE VESA ZIDNOG NOSAČA	Dimenzije šablona za bušenje	Dimenzije vijaka	Dužina (X)	Navoj (Y)
<b>Български</b>	РАЗМЕРИ ЗА КОМПЛЕКТ ЗА МОНТАЖ НА СТЕНА VESA	Размери на отвора (mm)	Размер на болта	Дължина (X)	Резба (Y)
<b>Lietuvių</b>	VESA TVIRTINIMO PRIE SIENOS MATAVIMAI	Angos šablono dydis (mm)	Varižtu dydis	Ilgis (X)	Sriegis (Y)
<b>Latviešu</b>	VESA SIENAS STIPRIŅĀJUMA IZMĒRI	Sauruma šablona izmērs (mm)	Skrūvju izmēri	Garums (X)	Vītne (Y)
<b>Eesti</b>	VESA SEINALE KINNITAMISE MÕÕDUD	Kruvi saurus mõõli (mm)	Kruvi saurus	Kõrgus(X)	Keete (Y)
<b>Shqip</b>	PERMASAT E NJËSISË SË MONTIMIT NË MUR VESA	Madhësitë modele të vrimave (mm)	Madhësitë e vidhave	Gjatësia (X)	Filetimi (Y)
<b>عربی</b>	مقاسات تثبيت على الحائط VESA	مقاسات النظام على الحائط (مم)	مقاسات البراغي (مم)	الطول (X)	النسب (Y)
<b>עברית</b>	VESA מוסך התלייה על הדיור (מ"מ)	גודל תבנית החורים (מ"מ)	גודל הברגים	אורך (X)	תבנית (Y)
<b>فارسی</b>	اندازه گیری نصب دیواری VESA	اندازه های الگوی سوراخ (میلی متر)	اندازه های پیچ	طول (X)	رشته (Y)