

技术要求:

- 1.材质: 铜版纸, 材质符合ROHS标准, 纸张克重 80gsm;
- 2.尺寸: A4大小;
- 3.彩色印刷, 印刷字迹清晰明了.

						名称 英国ARGOS F965TMSE86 & F965TMSE86-SB BRCNB90SPSS & BRCNB90SPBK说明书	图号 KSMS-ARGOS-01-002	
①	1	1	P18ZK073		2018.6.12	品号 40400400188	材料 铜版纸	
设计		2018.6.12	标准化			阶段标记		数量
校对							1	
审核								
工艺			批准			共 1 张 第 1 张	浙江安德电器有限公司	

BUSH

Instruction manual

Freestanding Cookers

BRCNB90SPSS

BRCNB90SPBK



You'll soon be enjoying your new Freestanding Cooker

It all begins here, with your instructions. Don't worry, there's nothing too technical coming up. Just simple, step-by-step guidance to get you up and running quickly. Sound good? Then let's get started.

Help and Guidance

We're here to help you get the most from your Freestanding Cooker. Should you require any guidance, a simple solution can often be found online at:

www.bush-support.co.uk

If you still require further assistance, call one of our experts on **01759 487838**.

Contents

1 Safety information

Safety information 6

2 Getting to know your Freestanding Cooker

Ready? Let's begin 10

Accessories 11

3 Installing your Freestanding Cooker

Installation requirements 14

Data Label 14

First Use 14

Unpacking 14

Technical Data 14

Connections (electrical, water, gas) 15

Surfaces 15

Installation details 16

Gas Conversion 19

4 Using your Freestanding Cooker

Controls 22

Using the cooktop burners 22

Using the oven 23

Cooking modes 25

Using the digital clock 26

Practical advice 27

Cooking guides 28

5 Care and Maintenance

Cleaning 32

Removing the door 33

Replacing the lamps 33

Maintenance 34

Technical specifications 35

6 Product support

Troubleshooting 38

Help and assistance 39

Declaration of conformance to product standards 40

Disposal 40

Guarantee 41

Safety information

1





Safety information

Important - Please read these instructions fully before installing or operating

INSTALLATION WARNINGS

IMPORTANT: This product **MUST** be installed by a qualified Gas Safe registered installer in accordance with local regulations. Particular attention should be given to the ventilation requirements.

IMPORTANT: Prior to Installation ensure that the local supply conditions (gas type and pressure, electricity voltage and frequency) are compatible with the requirements of your cooker.

IMPORTANT: Carefully unpack and examine the appliance for any damage. If you think there is a defect, do not use the appliance and contact Bush Product Support on 01759 487838. Packaging materials should be collected together and disposed of immediately as they may be harmful to children.

IMPORTANT: Keep the electrical cable (not supplied) of your cooker away from the hot areas of your cooker; do not let the cable touch the appliance. Keep the cable away from sharp edges and heated surfaces.

IMPORTANT: Ensure that the electric supply cable is not trapped or damaged during installation.

IMPORTANT: In the event that the cable connecting your cooker becomes damaged, it must be replaced by a suitably qualified person. This cable must not be replaced by an unauthorised person.

IMPORTANT: Protect your cooker against atmospheric effects. Do not expose your cooker to effects such as sun, rain, snow etc.

IMPORTANT: The materials surrounding the appliance (cabinets) must be able to withstand a minimum temperature of 100°C.

IMPORTANT: When using your oven for the first time your cooker may give off an unusual odour from the heating elements and insulation materials. This is normal for new cookers. To eliminate this odour run the oven at 250 degrees for 40-60 mins with the oven empty.

WARNING: Before obtaining access to terminals, all supply circuits must be disconnected.

DURING USAGE

IMPORTANT: This appliance can be used by children aged from 8 years and above and persons with reduced physical, sensory or mental capabilities or lack of experience and knowledge if they have been given supervision or instruction concerning use of the appliance in a safe way and understand the hazards involved. Children shall not play with the appliance. Cleaning and user maintenance shall not be made by children without supervision.

WARNING: The appliance and its accessible parts become hot during use. Care should be taken to avoid touching heating elements. Children less than 8 years of age shall be kept away unless continuously supervised.

WARNING: Cooking on a hob with fat or oil can be dangerous and should not be left unattended.

WARNING: NEVER try to extinguish a cooking fire with water. Instead switch off the appliance and cover flame e.g. with a lid or a fire blanket.

CAUTION: Cookers may topple forward if a child climbs onto the cooker door. Children should be supervised in the kitchen at all times and this cooker must be secured to the wall using the fixing kit (included) to prevent accidents.

CAUTION: Do not allow children in the kitchen when cooking or while cooker parts may still be hot. Many parts of the cooker will become hot and present a considerable hazard to children.

CAUTION: When the oven is hot never touch the oven glass by hand or with tools.

CAUTION: Before starting to use your appliance, ensure curtains, paper or flammable items are kept away from your appliance. Do not keep flammable materials inside of or around your cooker.

CAUTION: Take care when closing the oven door that there is nothing obstructing it from closing as this may break the glass door.

IMPORTANT: When using the grill the oven door must be kept closed.

If you require any technical guidance or find that your product is not operating as intended, a simple solution can often be found in the **Troubleshooting** section of these instructions.



Safety information

Important - Please read these instructions fully before installing or operating

IMPORTANT: Position pans over the centre of the burners and turn handles to a safe position where they can not be knocked or grabbed.

IMPORTANT: Make sure the cooker control knobs are all in the off position when not in use.

IMPORTANT: If you do not intend to use your cooker for a long period of time turn off the gas and electric supply to the cooker.

CAUTION: Using gas cooking appliances results in the production of heat, moisture and the products of combustion. Ensure that the room where your cooker is installed is well ventilated particularly while the cooker is in use. Keep natural ventilation holes open or install a mechanical ventilation device (extractor hood) Prolonged intensive use of your cooker may call for additional ventilation (by opening a window) or by increasing the level of mechanical ventilation where present.

GENERAL SAFETY WARNINGS

IMPORTANT: This appliance has been designed for non-professional, domestic use only. Do not use this cooker for commercial use or any other application e.g. room heating.

WARNING: Danger of fire: do not store flammable items on or near the cooking surfaces or inside the oven.

IMPORTANT: Do not try to lift or move this cooker by pulling on the door handle.

WARNING: Ensure that the appliance is switched off before replacing the lamp to avoid the possibility of electric shock.

IMPORTANT: Your appliance is produced in accordance with all applicable local and international standards and regulations.

IMPORTANT: Maintenance and repair work must only be performed by authorised service technicians. Installation and repair work that is carried out by unauthorised technicians is dangerous and could invalidate your guarantee.

IMPORTANT: When the door of the oven is open, do not hang or lean anything on it. You may unbalance your appliance or damage the door or door hinges.

IMPORTANT: Do not hang towels, dishcloths or clothes from the cooker or its handles.

CLEANING AND MAINTENANCE

IMPORTANT: Always turn the appliance off before operations such as cleaning or maintenance. You can do this by switching the cooker off using cooker isolation switch.

IMPORTANT: Do not remove the control knobs to clean the control panel.

WARNING: Do not use harsh abrasive cleaners or sharp metal scrapers to clean the oven door glass since they can scratch the surface, which may result in shattering of the glass.

TO MAINTAIN THE EFFICIENCY AND SAFETY OF YOUR APPLIANCE, WE RECOMMEND YOU ALWAYS USE OUR AUTHORISED SERVICE AGENTS AND ORIGINAL SPARE PARTS.

FOR ASSISTANCE CALL BUSH PRODUCT SUPPORT 01759 487838.

Getting to know your Freestanding Cooker

2



Getting to know your Freestanding Cooker

You'll be up and running in no time

Ready? Let's begin...

Please read these instructions carefully. They contain important information which will help you get the best from your Freestanding Cooker and ensure safe and correct installation and operation.

If you require any further assistance, our technical experts are happy to help. For full details, refer to the product support section at the end of these instructions.

If you require any technical guidance or find that your product is not operating as intended, a simple solution can often be found in the **Troubleshooting** section of these instructions,

Getting to know your Freestanding Cooker

You'll be up and running in no time



1. Timer Controls
2. Oven Door
3. Rapid Burner
4. Semi-rapid Burner
5. Wok Burner
6. Auxiliary Burner
7. Semi-rapid Burner
8. Trivets
9. Burner Control Knobs
10. Oven Controls Knobs
11. Wire Shelves
12. Oven

or online at www.bush-support.co.uk If you still require further assistance, call one of our experts on 01759 487838

Getting to know your Freestanding Cooker

You'll be up and running in no time

Accessories

1. Grill pan & handle set
2. Two wire shelves
3. Gas Elbow
4. Fixing Assembly
5. LPG Nozzles
6. Non-slip Feet



Oven & Accessories

The oven is supplied with chrome wire Shelf Supports and a range of shelf options as shown below. There are four shelf positions on the oven.

Installing your Freestanding Cooker

3



Installing your Freestanding Cooker

Bringing it all together

Installation requirements

THIS COOKER MUST BE INSTALLED ACCORDING TO BS 6172: 2010 BY A SUITABLY QUALIFIED GAS SAFE REGISTERED INSTALLER



- **IMPORTANT: CONTACT AN AUTHORISED SERVICE AGENT FOR INSTALLATION OF YOUR OVEN!**

Data Label

The Data Label is located on the rear of the appliance. A duplicate Data Label is supplied to adhere in an accessible area next to the appliance. This appliance is suitable for Natural Gas and Universal LPG; ensure that the available gas supply matches the Data Label and the gas type label.

First Use

IMPORTANT: When using your oven for the first time your cooker may give off an unusual odour from the heating elements and insulation materials. This is normal for new cookers. To eliminate this odour run the oven at 250 degrees for 40-60 mins with the oven empty.

Unpacking

Carefully unpack and examine the appliance for any damage. If you think there is a defect, do not use the appliance and contact Product Support on 01759 487838.

Packaging materials should be collected together and disposed of immediately as they may be harmful to children.

Levelling feet

The height and level of the appliance can be adjusted by rotating the feet located underneath the appliance at each corner. Rotate in a clockwise direction to decrease the height and anti clockwise to increase the height. The levelling feet need to be installed on the bottom of the cooker in the first instance before cooker can be adjusted for balancing.

Technical Data

Inner dimensions of the oven

Width: 69cm Depth: 43cm Height: 38cm

Inner Volume of the oven: 105 litres.

Voltage & Frequency of power supply: 240V – 50Hz

Electrical features:

Oven Light: 2x25W

Spit motor : 4W

Top inner heating element: 2900W

Top outer heating element: 2200W

Bottom heating element: 1800W

Rear heating element: 1950W

Motor Ventilator: 2x20W

Cooling fan: 18W

If you require any technical guidance or find that your product is not operating as intended, a simple solution can often be found in the **Troubleshooting** section of these instructions.

Installing your Freestanding Cooker

Bringing it all together

Installation of Cooker

Gas

This modern cooker was manufactured with parts and materials of the highest quality and was designed to meet your cooking needs. You should read this manual so that you are able to use the cooker correctly and to avoid any potential problems with using the cooker. The following information outlines the required rules for correct installation and service of your cooker. This is particularly important for the technician who will install the appliance.

CONTACT AN AUTHORISED SERVICE AGENT FOR INSTALLATION OF YOUR OVEN!

VENTILATION REQUIREMENTS

For rooms with a volume of less than 5 m³ - permanent ventilation of 100 cm² is required see figure 1 and 2 for an example.

For rooms with a volume of between 5 m³ and 10m³ a permanent ventilation of 50 cm² will be required unless the room has a door which opens directly to the outside, in which case no permanent ventilation is required.

For rooms with a volume greater than 10 m³ - no permanent ventilation is required.

Attention: Regardless of room size, all rooms containing the appliance must have direct access to the outside air via an openable window or equivalent. The room containing the cooker should have an air supply in accordance with BS 5440: Part 2.

Environment where your appliance will be installed

Your cooker must be set up and used in a place where it will always have ventilation. While operating, this appliance needs 2m³/h air per kw input.

There must be enough natural ventilation to provide the gas to be used in the environment. The average air flow must directly come in through ventilation from the outside.

Emptying of the Burned Gases from Environment

For cooking appliances that operate with gas, burned gas wastes are exhausted directly to the outside or through cooker hoods that are connected to a chimney that opens directly to the outside. If it is not possible to install a cooker hood, it is required to set an electric fan on the window or wall that has access to fresh air. This electric fan must have the capacity to change the volume of air in the kitchen environment 4-5 times per hour.

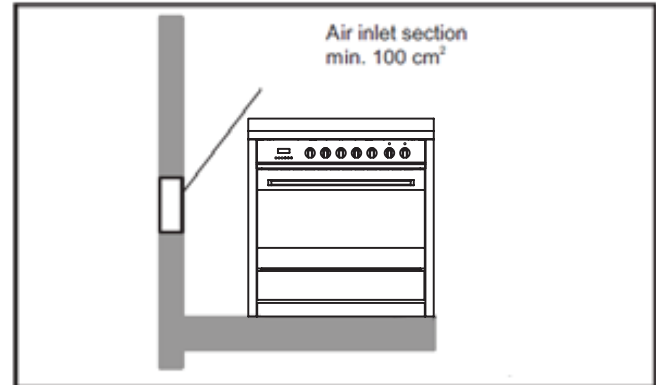

Figure 1

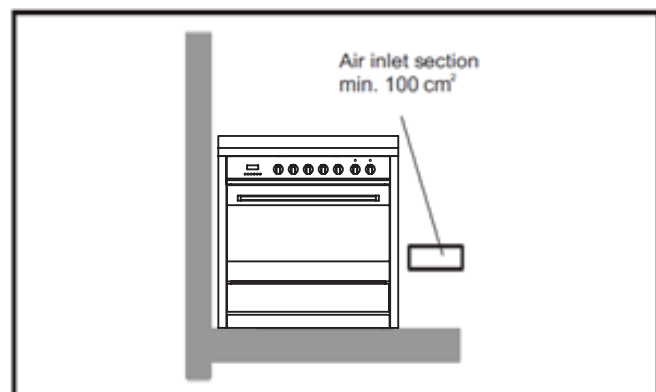

Figure 2

Installing your Freestanding Cooker

Bringing it all together

Gas Connection

IMPORTANT - All Gas installations must be carried out by a suitably qualified person. For information on choosing a gas installer contact the 'Gas Safe Register'.

www.gassaferegister.co.uk

The appliance can be placed close to other furniture on condition that the furniture's height does not exceed the height of the cooker panel. Make sure that there are no combustible or flammable materials, such as curtains, in the vicinity of the installation.

There must be at least 2cm of free space between the back wall and the rear of the appliance to allow for ventilation and air circulation.

Positioning

The furniture close to the cooker must be manufactured resistant to temperatures up to 100°C.

If the kitchen furniture are higher than the hob plate of the cooker, it must be at least 10cm away from the cooker's side.

Surrounding furniture, cabinets and extractor fans should be positioned in accordance with the diagram shown in figure 3. If fitted, the extractor fan must be at least 65cm above the hob.

If no fan is fitted the minimum distance between the hob and any cabinet or other structure must be 70cm.

Adjustment of feet

The height and level of the appliance can be adjusted by rotating the feet located underneath the appliance at each corner. Rotate in a clockwise direction to decrease the height and anti clockwise to increase the height.

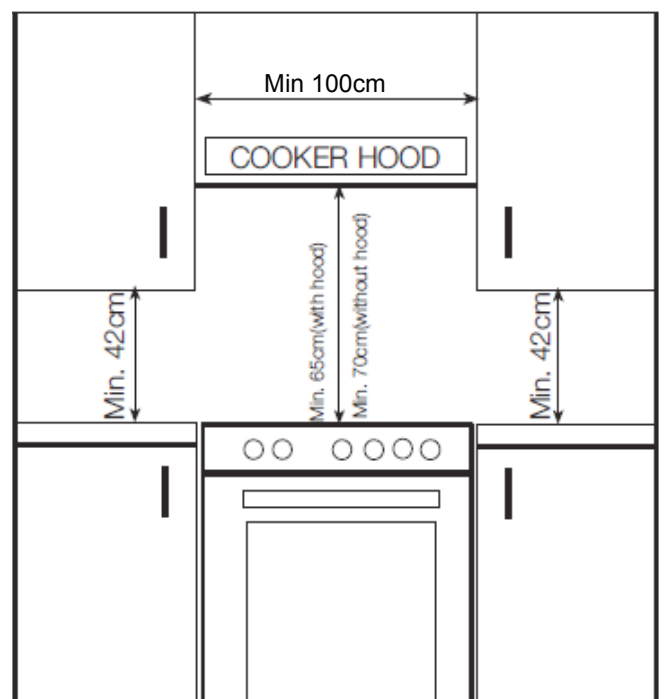

Figure 3

If you require any technical guidance or find that your product is not operating as intended, a simple solution can often be found in the **Troubleshooting** section of these instructions,

Installing your Freestanding Cooker

Bringing it all together

Anti-tilting chain

The cooker is supplied with an anti-tilting chain to prevent the appliance from tilting forward and causing accidental damage to the gas pipe. Make a hole in the wall behind, at the same height as the fixing chain. Using the fixing assembly (page 12 fig.4) insert the plug into the hole and then screw in the hook until it is firmly fixed to the wall. Fix the chain to the hook. You can adjust to the level of the cooker by inserting the feet provided.

Installing your Freestanding Cooker

Bringing it all together

Electrical connection

IMPORTANT: Electrical connections must be carried out by a suitably qualified person and in accordance with all relevant local building and installation regulations.

The electrical cable (not supplied) should not be routed through any area that may be affected by heat from the oven, especially the area directly behind the oven.

1. See the rating label at the rear of the product for the appliance's load rating.
2. The cooker must be connected to a dedicated circuit suitably rated for the load of the appliance (see rating label at rear of appliance) as shown in the wiring diagrams below. It must be connected via a suitably rated cable to a double pole isolator cooker switch also suitably rated for the appliance.
3. The electrical cable should not touch the hot parts of the appliance. .

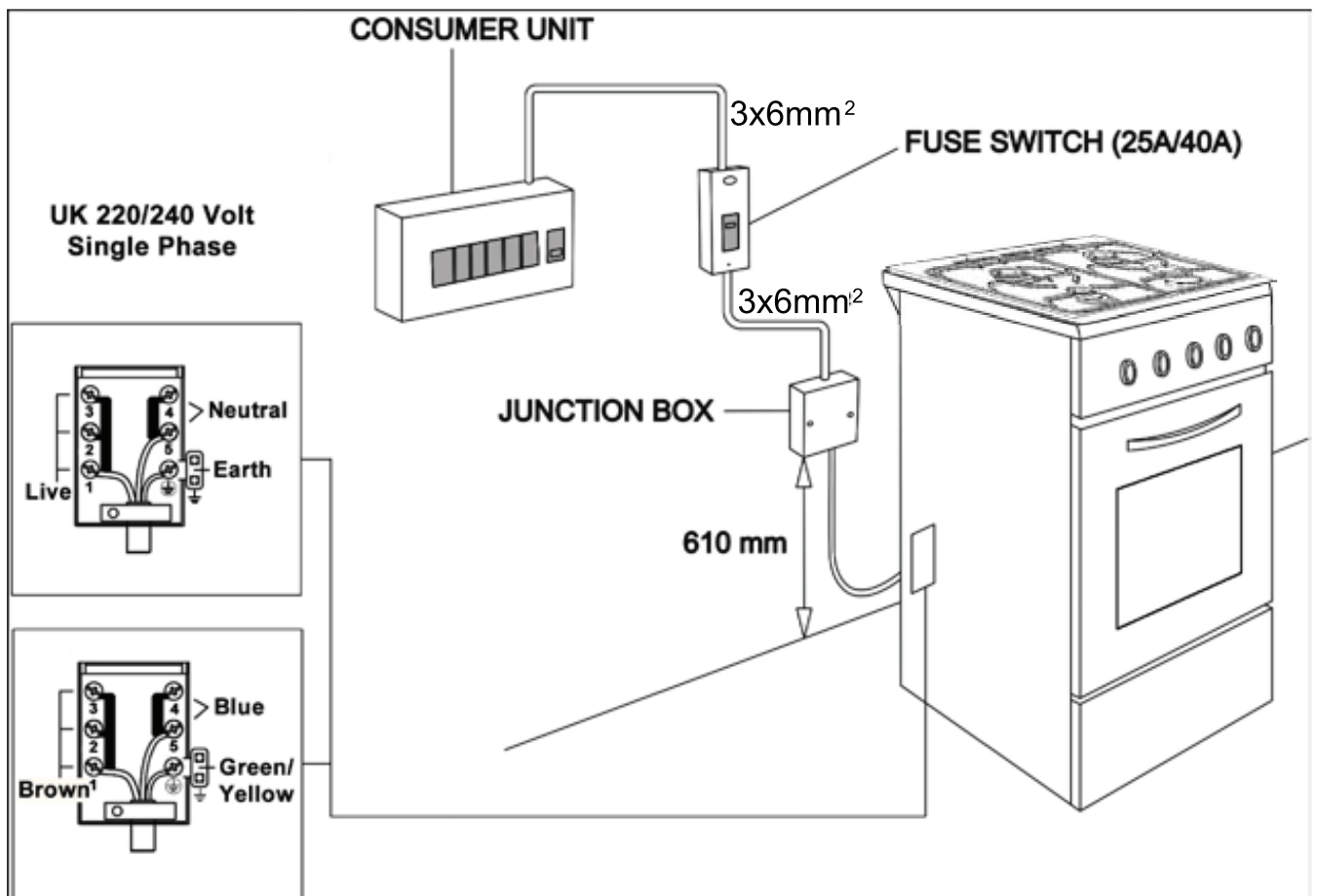

If you require any technical guidance or find that your product is not operating as intended, a simple solution can often be found in the **Troubleshooting** section of these instructions.

Installing your Freestanding Cooker

Bringing it all together

Gas Conversion (NG to U-LPG)

Parts needed

- Test Point Assembly
- Auxiliary Jet 00.53mm
- Wok Jet 01.00mm
- ULPG Gas Type label
- Semi-Rapid Jet 00.68mm
- Rapid / Fish Jet 00.88mm

Converting to a different gas type

CONVERSION TO A DIFFERENT GAS TYPE MUST BE CARRIED OUT BY A SUITABLY QUALIFIED GAS SAFE REGISTERED INSTALLER

Changing the jets

1. Remove pan supports, burner heads and caps.
2. Use a size 7 socket wrench to unscrew and remove the jets, replacing them with those supplied in the conversion kit. Ensure you use the correct jet for the corresponding burner.
3. Reassemble the burner heads, caps and pan supports.
4. Fit the Gas type label supplied in the conversion kit next to the gas connection point and remove the existing label.



Setting the minimum level

1. Light one of the burners and turn the tap to minimum flame.
2. Remove the corresponding control knob.
3. Use a thin blade screwdriver to turn the by-pass screw located above left of the gas valve shaft as shown right. Turn the by-pass screw fully clockwise. The result should be a small, stable flame which is uniform around the entire burner ring. If not, turn the by-pass screw anti-clockwise until satisfied with the flame.
4. Check that the burner does not go out when the tap is turned quickly from the maximum to the minimum position.
5. Repeat for each burner.



Using your Freestanding Cooker

4



Using your Freestanding Cooker

Getting the most from your appliance

Controls

Digital Automatic Clock

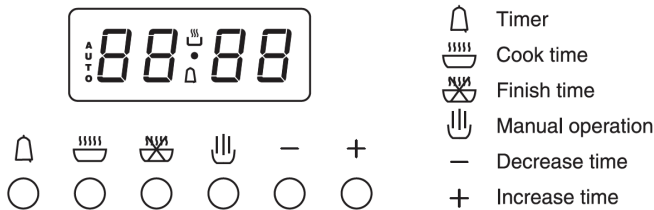

Control knob (Cooktop Burners)

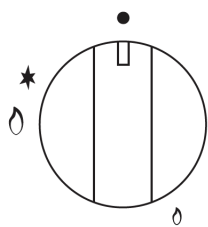

Cooking Temperature Selection Knob

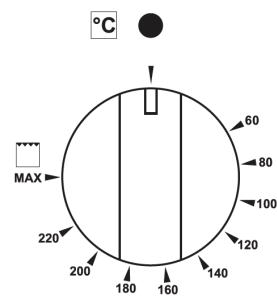

Cooking Mode/Selection Knob

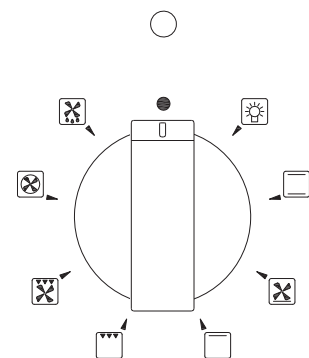

Instructions for use (cooktop burners)

The symbols on the control knobs mean the following:

- No gas flow or 'Off'
- ★ Maximum gas flow or 'high' flame and lighting position
- 🔥 Minimum gas flow or 'low' flame

All operating positions must be set between the maximum and minimum flow settings, and never between the maximum setting and the closed position.

Gas Burner Components

- A Burner cap
- B Burner Head
- C Burner Bowl
- D Thermocouple (where fitted)
- E Electrode

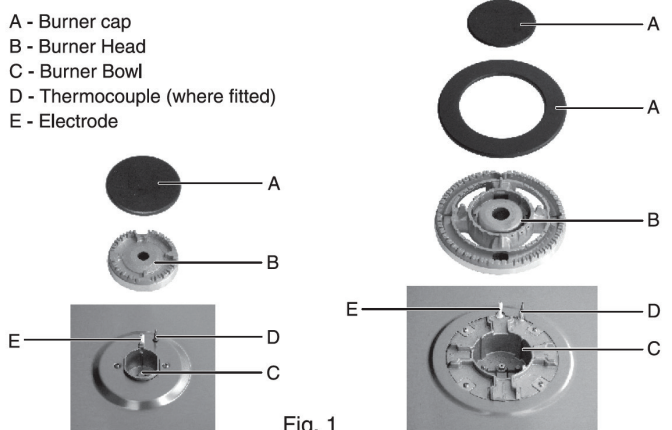

Fig. 1

These parts can be removed for cleaning periodically. After cleaning, they must be well dried and correctly replaced. It is important to check that the burner bowl and cap have been correctly positioned. Failure to do so can cause serious problems.

If you require any technical guidance or find that your product is not operating as intended, a simple solution can often be found in the **Troubleshooting** section of these instructions.

Using your Freestanding Cooker

Getting the most from your appliance

To light the cooktop burners

To light the burner, press the control knob fully down and hold the knob down before rotating anti clockwise to the High Flame position. The ignition device is integrated into the control knob and is automatically activated by pushing down on the control knob.

After lighting the flame, keep the knob pressed for about 10 seconds: this time is necessary to heat up the thermocouple and activate the safety valve, which would otherwise cut off the gas flow. This step only applies where flame failure device is fitted.

In the instance of a power failure, place a lit match near the burner and proceed as described above. If the flame does not light after the first attempt, wait 5 minutes for the gas to dissipate before attempting to re-light the burner.

Once lit, check that the flame is even and turn the control knob to adjust the flame as required. If the flame is uneven, check that the 'burner head/skirt' and 'burner cap' are correctly positioned. To turn off the flame, turn the control knob clockwise to the off position (● symbol) Before removing pots or pans from the burners, always turn off the flame.

For correct use of the cooktop

For lower gas consumption and better efficiency, use only flat-bottomed pan of dimensions suitable for the burners, as shown in the table below. Also as soon as a liquid comes to the boil take care to turn the flame down to a level that will just keep it boiling.

The use of pans in excess of the maximum diameter recommended in the table above can result in over heating/discoloration of hob surface. During cooking processes involving fats and oils, watch your foods carefully because these substances may catch fire if overheated.

How to use your oven

This multi-function oven combines the advantages of traditional convection ovens with modern fan assisted ovens in a single appliance. It is an extremely versatile appliance that allows you to choose easily and safely between different cooking modes. The various cooking modes are selected by means of a cooking mode selection knob, located on the control panel.

To operate the oven:

- Ensure that manual mode is selected (page 26)
- Turn the cooking mode selection knob to the desired cooking mode (explanation of cooking modes on page 25)
- Turn the cooking temperature selection knob to the desired temperature (cooking guide is on pages 29) or to 'MAX' if grilling.

The first time you use your appliance, we recommend that you set the thermostat to the highest setting, set the cooking mode selection knob to a cooking mode and leave the oven on for about half an hour with nothing in it and the oven door shut. Then, open the oven door and allow the oven to cool. Any odour that may be detected during this initial use is due to the evaporation of substances used to protect the oven during storage.

Burner	Min. Diameter	Max. Diameter
Large (rapid)	150mm	260mm
Medium (semi-rapid)	130mm	180mm
Small (Auxiliary)	90mm	160mm
Triple Flame (Wok)	210mm	270mm

Using your Freestanding Cooker

Getting the most from your appliance

Positioning the oven trays & shelves

The Baking Tray, Grill Tray or Oven Shelf can be located in any of the five height positions in the oven if your oven does not have Telescopic Shelf Supports. Oven Shelves cannot be fitted to the Telescopic Support. Only fit the Baking Tray or Grill Tray to the Telescopic Support.

When fitting the trays or shelves, ensure they are fitted between the two wires that are closest together as shown below. Oven Shelves have a stop so that they are not fully withdrawn by accident. To fully remove the Oven Shelves, lift the front of the shelf slightly and withdraw fully from the oven. Note that the Grill Tray and Baking Tray do not have a stop position and can be fully withdrawn without interruption, so be careful not to accidentally fully withdraw the trays.



Fit Trays and Shelves between bars as shown below.

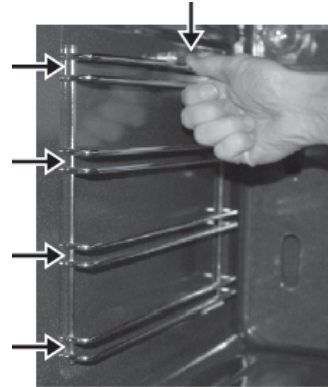

To remove the Oven Shelf Support, push down on the wire below the locking pin, pull away from the oven wall until you can release the bottom of the support from the holes in the oven wall. Replace in reverse procedure.



Above: Fitting the oven shelf to the chromed shelf supports

Note: Place the Baking Tray provided on the bottom shelf position of the oven to prevent any spillages from dripping onto the bottom of the oven. **Never place anything (including foil and oven trays) on the bottom of the oven when it is in operation because this could damage the enamel.** Only place your cookware (dishes, trays, aluminium foil, etc.) on the Oven Shelves provided with the appliance.

If supplied, use the chrome wire handle shown below when removing the trays from the oven.

If you require any technical guidance or find that your product is not operating as intended, a simple solution can often be found in the **Troubleshooting** section of these instructions,

Using your Freestanding Cooker

Getting the most from your appliance

COOKING MODES



Defrost mode

When set to 'Defrost' mode, the fan located at the back of the oven circulates room temperature air around the food. This is recommended for the defrosting of all types of food, but in particular for delicate types of food which do not require heat, for example: ice cream cakes, cream or custard desserts, fruit cakes, etc. By using 'Defrost' mode, the defrosting time is approximately halved. In the case of meat, fish and bread, it is possible to accelerate the process by selecting 'Multi Cooking mode' and setting the temperature between 0°C to 100°C.



Convection mode

When set to Convection mode, the top and bottom heating elements operate together like a 'normal' conventional oven that you have probably used before.

Convection mode is best suited for traditional baking and roasting and you should only use one shelf at a time, otherwise the heat distribution will be uneven. You can balance the amount of heat between the top and the bottom of the dish by selecting a different shelf height. If you want more heat at the top of the dish place the dish on the top or second shelf. For more heat at the bottom of the dish, place the dish on third or fourth shelf.



Baking mode

When set to Baking mode, the fan element and the fan operate providing a delicate heat distributed uniformly throughout the oven.

This mode is ideal for baking and cooking delicate foods on multiple shelves, especially cakes that need to rise such as cream puffs and for certain tartlets, sweet or savoury biscuits, savoury puffs, swiss rolls and small portions of vegetables, etc.



Grill Mode

Select 'Grill' mode with cooking mode selection knob and turn cooking temperature selection knob to 'Max'. When set to Grill mode, the top inner element operates. The extremely high and direct temperature of the grill make it possible to brown the surface of meats and roasts while locking the juices in to keep the tender. Grill mode can also be used for dishes that require a temperature on the surface such as beef steaks, veal, rib, steak, filets, hamburgers, etc.

Grill food with the oven door closed.



Top heat mode

When set to Top heat mode, the top heating element operates. This mode can be used to brown food at the end of cooking.



Fan assisted Top Heat mode

Select a 'Fan Assisted Top' mode with cooking mode selection knob and turn cooking temperature selection knob to the desired temperature setting. When set to Fan Assisted Top mode, the top inner element and the fan operate. This mode increases the circulation of air throughout the oven, which helps prevent food from burning on the surface, allowing the heat to penetrate right into the food. Particularly suitable for kebabs made with meats and vegetables, sausages, ribs, lamb chops, chicken, quail, pork chops, fish steaks, stuffed cuttlefish etc.



Delicate cooking mode

When set to Delicate cooking mode, the bottom element and the fan will operate. This mode is suitable for pastries, cakes and no dry sweets in baking tins or moulds that require heat from the bottom.

Using your Freestanding Cooker

Getting the most from your appliance

6 BUTTON DIGITAL CLOCK

This model has a digital display, 24hr clock with 6 control buttons. When the power is connected, the screen displays 3 flashing numbers and 'AUTO'.

Adjusting the digital clock



For first use of cooker, the time must be set by using the digital timer. The time must be set every time the cooker has been reset by the mains. To set the correct time, press the  button first, then + or - button to advance forward or backward until the correct time is displayed.

Manual operation setting

If 'AUTO' is flashing, automatic or semi-automatic program has been set. Press  button, 'AUTO' will clear from the display and the oven can be operated manually.



Automatic setting

Automatic setting of the oven allows you to select the end time, cooking time, temperature and cooking mode. The oven will switch on, cook according to the selected cooking mode and temperature and then switch off automatically.

1. Press  button, set cooking time with + and - buttons.
2. Press  button, set roast finish time with + and - buttons.
3. Set cooking temperature and cooking mode by turning the thermostat knob and selector knob.

After the above setting, 'AUTO' will illuminate, which means the automatic cooking feature of the oven is set.

For example: if cooking time takes 45 minutes and you want it to finish at 14:00:

1. Press  and set the cook time to 45 minutes using + and - buttons.
2. Press  and set the finish time to 14:00 using + and - buttons.

After the above setting, the current time is displayed and 'AUTO' will flash, indicating that the automatic cooking feature is set. When the clock displays 13:15, the oven will start cooking automatically. While cooking, 'AUTO' and  will flash.

When the clock displays 14:00, the oven automatically stops cooking. The alarm will ring and 'AUTO' will flash, press the  button and the ringing will stop.



Semi-automatic setting

There are two methods of semi-automatic cooking:

A. Start cooking now and set cooking time:

This semi-automatic setting of the oven allows you to start cooking immediately, set the cooking time (up to 10 hours), select the temperature and cooking mode. The oven will cook according to the selected cooking mode and temperature and then switch off automatically once the cooking time has elapsed.

1. Press  button, set cooking time with + and - buttons.
2. Set cooking temperature and cooking mode by turning the thermostat knob and selector knob.

The oven starts immediately,  and 'AUTO' will flash. After the cooking time has elapsed, the oven automatically stops cooking. The alarm will ring and 'AUTO' will flash, press the  button and the ringing will stop.



B. Start cooking now and set the finish time



1. Press  button, set cooking finish time with + and - buttons (up to 23 hours and 59 minutes).
2. Set cooking temperature and cooking mode by turning the thermostat knob and selector knob.

If you require any technical guidance or find that your product is not operating as intended, a simple solution can often be found in the **Troubleshooting** section of these instructions.

Using your Freestanding Cooker





Getting the most from your appliance

The oven starts immediately,  and 'AUTO' will flash. When the finish time is reached, the oven automatically stops cooking. The alarm will ring and 'AUTO' will flash, press the  button and the ringing will stop.

When the  button is pressed during semi-automatic cooking, the set cooking time is displayed. If the  button is pressed and the time is set back to 'O', the semi-automatic setting will be cancelled. When  button is pressed again, the oven will revert to the manual mode.

Timer

The digital countdown timer can be set up to 23 hours and 59 minutes maximum.

To set the timer, press the  button and then + or - button until the desired time is displayed. Once the  button is released, the current time and U is displayed. When the  button is pressed the remaining time is displayed. When the set time is reached,  disappears and the alarm will ring. To stop the alarm, press the  button.

Note: After pressing the  button, timer settings should be done within 5 seconds.

In case of a power failure, all settings including the time display will be lost. When the power is returned, three 'O' and 'AUTO' will be displayed.

The oven light

Set cooking mode selection knob to  symbol to switch on the oven light/s. The oven light/s stay on when the oven is operating.

Cooling ventilation



In order to cool down the exterior of the appliance, this model is equipped with a cooling fan, which switches on automatically. When the cooling fan is on, you will notice a flow of air exiting between the oven door and the control panel.

Note: When cooking is finished, the cooking fan continues to operate until the oven cools down and then switches off automatically.

PRACTICAL COOKING ADVICE

The oven offers a wide range of settings which allow you to cook any type of food in the best possible way. With time you will learn to make the best use of this versatile cooking appliance and the following directions are only a guideline which may be varied according to your own personal experience.

Preheating

If the oven needs to be preheated, the 'Convection' mode  or 'Baking' mode  should be selected. These are the most efficient modes, which will reach the desired temperature as quickly as possible using the least amount of energy.

Once the food has been placed in the oven, the desired cooking mode should then be selected.

Multi shelf cooking

If you want to cook food on several shelves, select the 'Baking' mode  as this is the only cooking mode that allows you to do so.

When cooking delicate foods on more than one shelf, use the 'Baking' mode. This mode allows you to cook on 3 shelves at the same time. Refer to the 'Cooking Guide' table.

Using your Freestanding Cooker

Getting the most from your appliance

Using the Grill

This multi-function oven has 2 different grilling modes.

Use the 'Grill' mode  with the oven door ajar, place the food on the centre of the grill pan, insert and fit the grill pan on either the 3rd or 4th shelf from the bottom. Note: only the central part of the top heating element operates for grilling.

When using 'Grill' mode, we recommend you set the thermostat to the highest setting. However, this does not mean you cannot use lower temperatures, simply adjust the thermostat knob to the desired temperature.

Use 'Fan assisted grill' mode  with the oven door shut. This mode is very useful for grilling foods rapidly, as the distribution of heat by the fan makes it possible not only to brown the surface, but also to cook the bottom of the food. It can also be used for browning foods at the end of the cooking process, such as adding that gratin finish to pasta bakes for example.

When using 'Fan assisted grill' mode, place the food on the 2nd or 3rd oven shelf from the bottom, then place a dripping-pan on the 1st rack from the bottom to prevent fat and grease from dripping onto the oven floor. We recommend you set the thermostat to 200°C, as it is the most efficient temperature for 'Fan assisted grill' mode. However, this does not mean you cannot use lower temperatures, simply adjust the thermostat knob to the desired temperature.

Important: for best results and to save energy, always use the 'Fan assisted grill' with the oven door **shut**.

Baking cakes

When baking cakes, always place them in a preheated oven. Make sure you wait until the oven has been preheated thoroughly (the indicator light will turn off). To prevent heat loss and the cake from dropping, do not open the oven door during baking.

In general...

... if pastry is too dry

Increase the temperature by 10°C and reduce the cooking time.

... if pastry has dropped

Use less liquid or lower the temperature by 10°C.

... if pastry is too dark on top

Place it on a lower shelf, lower the temperature, and increase the cooking time.

... if cooked well on the inside but sticky on the outside

Use less liquid, lower the temperature, and increase the cooking time.

... if the pastry sticks to the pan

Grease the pan well and sprinkle it with a dusting of flour or use greaseproof paper.

... if I used multi shelf cooking and one shelf is more cooked

Use a lower temperature setting next time. It is not necessary to remove the food from all the racks at the same time.

Using your Freestanding Cooker

Getting the most from your appliance

Cooking pizza

For best results when cooking pizza:

- Preheat the oven for at least 10 minutes.
- Use a light aluminium pizza pan, placing it on the shelf supplied with the oven. Don't use the dripping pan since this will extend the cooking time, making it difficult to get a crispy crust.
- Do not open the oven door frequently while the pizza is cooking;
- If the pizza has a lot of toppings (three or four), we recommend you add the mozzarella cheese on top halfway through the cooking process.
- For best results, only use one shelf at a time, but if you want to cook on two shelves, use the 2nd and 4th racks from the bottom with a temperature of 220°C and swap them halfway through cooking.

Cooking fish and meat

When cooking white meat, fowl and fish, use a temperature setting from 180°C to 200°C.

For red meat that you want well done on the outside while tender and juicy in the inside, it is best to start with a high temperature setting (200°C-220°C) for a short time, then turn the oven down afterwards.

In general, the larger the roast, the lower the temperature setting. Place the meat on the centre of the shelf and place the dripping pan beneath it to catch the fat.

Make sure that the shelf is inserted so that it is in the centre of the oven. If you would like to increase the amount of heat from below, use a lower shelf height. For savoury roasts (especially duck and wild game), dress the meat with lard or bacon on the top.

Care and maintenance

5



Care and maintenance

Looking after your appliance

Cleaning

WARNING! Isolate the power supply to the cooker and make sure that the oven is cool.

Before cleaning your oven or performing maintenance, make sure that the cooking mode selection knob and the cooking temperature selection knob is set to 'OFF'. To extend the life of your oven, it must be cleaned frequently.

The inside of the oven should preferably be cleaned immediately after use, when it is still warm (but not hot), with warm water and soap. The soap should be rinsed away and the interior dried thoroughly. Avoid using abrasive detergents, scourers, acidic cleaners such as lime scale remover, etc, as these could damage the enamel, and can result in development of rust and corrosion. If stains are particularly tough to remove, use cleaners specifically recommended to clean ovens and follow the instructions provided with the cleaner. **Never use steam cleaner for cleaning inside the oven.**

Do not clean using caustic creams, abrasive cleaning powders, thick wire wool or hard tools. Enamelled parts of the oven can be damaged if excess cleaning liquids are not immediately removed.

After cleaning the interior parts of the oven with a soapy cloth, rinse it and then dry thoroughly with a soft cloth.

Clean the glass surfaces with special glass cleaning agents.

Never use flammable agents like acid, thinner or petrol when cleaning your oven.

Do not clean your oven with a steam cleaner.

Do not wash any part of your oven in a dishwasher.

Burner Caps:

Periodically, the enamelled pan support, enamelled covers and burner heads must be washed with warm soapy water, rinsed and dried. After drying them thoroughly, place them back in their original positions on the burners

Enamelled Parts:

In order to keep enamelled parts as new, it is necessary to clean them frequently with mild warm soapy water and then dry with a cloth. Do not wash them while hot and never use abrasive powders or abrasive cleaning materials. Do not leave anything spilled onto enamelled parts for long periods of time.

Stainless Steel:

Stainless steel parts must be cleaned frequently with mildly warm soapy water and a soft sponge and then dried with a soft cloth. Do not use abrasive powders or abrasive cleaning materials. Do not leave anything spilled onto stainless steel parts for long periods of time.

Care and maintenance

Looking after your appliance

How to remove the oven door

You can remove the oven door for better access to the oven when cleaning. Please see the instructions below for how to safely remove and replace the oven door.

Remove and assemble procedure

Remove and assemble procedure

- Open door fully
- Lift up and turn the small levers situated on the two hinges fully back
- Grip the door on the two external sides; shut it slowly until door contacts the clips. Then continue closing door until it is about 10cm from closing fully.
- Pull the door towards you, pulling it out of its seat. Door will gently come away from oven.
- To reassemble the door follow the above procedures backwards.

Please note if door does not come away from oven easily do not forcefully remove.

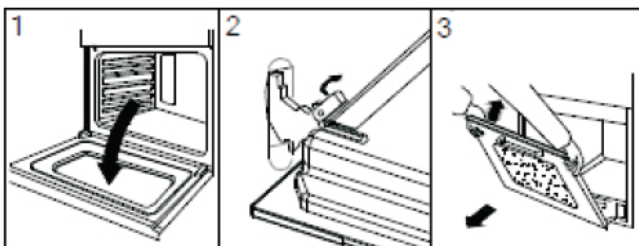

Replacing the oven lamps

WARNING: Ensure that the appliance is switched off before replacing the lamp to avoid the possibility of electric shock.

Remove the glass cover of the lamp-holder as shown below.

Remove the lamp and replace with a lamp resistant to high temperatures (300°C) with the following characteristics:

- Voltage: 220-240V
- Wattage: 25W
- Type: E 14

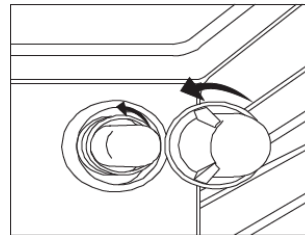

Replacement lamps are available from our Support Team. Replace the glass cover and reconnect the oven to the mains power supply.

Care and maintenance

Looking after your appliance

Routine maintenance

Have the condition and efficiency of the gas pipe and the pressure regulator (if installed) checked periodically. If anomalies are found, do not repair components but have the faulty component replaced. To ensure good performance and safety, the gas regulator taps must be greased periodically.

Periodic lubrication of the taps and any other appliance service must only be carried out by Authorised Personnel.

Abnormal operation

Any of the following are considered to be abnormal operation and may require servicing:

- Yellow tipping of the burner flame.
- Sooting up of cooking utensils.
- Burners not igniting properly.
- Burners failing to remain alight.
- Burners extinguished by cupboard doors.
- Gas valves, which are difficult to turn.

In case the appliance fails to operate correctly, contact our Support Team on 01759 487838.

Care and maintenance

Looking after your appliance

Technical specification

	BRCNB90SPSS	BRCNB90SPBK
Power supply	220-240V~50 Hz	220-240V~50 Hz
Maximum power (W)	2880-3428	2880-3428
Actual Product Size (W x D x H) mm	900 X 600 X 900	900 X 600 x 900
Net Weight (KG)	76.2	78.2
Main Oven Volume (L)	103	103
Second Oven Volume (L)	N/A	N/A
Energy rating	A	A

We apologise for any inconvenience caused by minor inconsistencies within these instructions that may occur due to product improvements and development

All images and drawings are for illustration purposes only.

Product support 6



Product support

Help is always at hand

Troubleshooting

1. If no electrical functions appear to work, check the cooker isolation switch has not been turned off also check the fuse in the switch and the circuit breaker in you consumer unit
2. After replacing the fuse or resetting the circuit breaker turn on individual parts of your cooker one at a time to check function
3. **DO NOT ATTEMPT TO REPAIR THIS COOKER YOURSELF. CALL BUSH PRODUCT SUPPORT ON 01759 487838 OR CONSULT A GAS SAFE REGISTERED INSTALLER**

Problem	Possible Cause	Solution
Only parts of the cooker work it may be that the ovens or the grill, do not work	Links may be missing in the rear connector box	Refer to the Quick Start Guide to check the correct placement of the links This must be done by a qualified competent person
Nothing works (completely dead)	Power is turned off at the isolation switch or the consumer unit Poor electrical connection	Ensure isolation switch is on Check consumer unit has not tripped out Have the connections checked by a qualified electrician
The hob burners do not operate correctly	Check if the burner parts are correctly assembled (especially after cleaning).	The gas supply pressure may be too low/high. For appliances working with bottled LPG, the LPG cylinder may be depleted.
Oven not heating up	Oven temperature not set correctly Door is not properly closed	Ensure that the correct temperature has been selected and the door is properly closed

If you require any technical guidance or find that your product is not operating as intended, a simple solution can often be found in the **Troubleshooting** section of these instructions.

Product support

Help is always at hand

Help and assistance

If you require any technical guidance or find that your Freestanding Cooker is not operating as intended, a simple solution can often be found in the **Troubleshooting** section of these instructions or online at www.bush-support.co.uk

If you still require further assistance, call one of our experts on **01759 487838***. To help give us give you a fast and efficient service please have the following information ready:

Model Ref.	<input type="text"/>	You can find these on the rating plate - a small information panel (usually a sticker or metal plate) on the rear of your appliance
Serial number	<input type="text"/>	
Date of purchase	<input type="text"/>	This will be shown on your receipt

Local call rates applies*

Lines open 8am-7pm Monday to Saturday and 10am-4pm Sunday.

*Calls to Bush enquiry lines may attract a charge and set up fee from residential lines depending on your call plan/tariff. Mobile and other providers costs may vary, see www.bt.com/pricing for details.

For Security and training purposes, telephone calls to and from customer service centres maybe recorded and monitored. Calls from Republic of Ireland will attract international call charges.

or online at www.bush-support.co.uk If you still require further assistance, call one of our experts on **01759 487838**

Product support

Help is always at hand

Declaration of conformance to product standards

This appliance conforms to all relevant standards applicable to domestic appliances sold in the UK

Disposal



This appliance/fitting is marked according to the European directive 2012/19/EU on Waste Electrical and Electronic Equipment (WEEE).

By ensuring this product is disposed of correctly, you will help prevent potential negative consequences for the environment and human health, which could otherwise be caused by inappropriate waste handling of this product.

The symbol on the product, or on the documents accompanying the product, the **crossed out wheelie bin** symbol, indicates that this appliance/fitting may not be treated as household waste. Instead it shall be handed over to the applicable collection point for the recycling of electrical and electronic equipment.

Disposal must be carried out in accordance with local environmental regulations for waste disposal.

For more detailed information about treatment, recovery and recycling of this product, please contact your local authority, your household waste disposal service or the retailer where you purchased the product.



Call us now and activate your 12 month guarantee

Thank you for choosing Bush. Your new product is guaranteed against faults and breakdowns for 12 months. Don't forget to register it with us today so we can provide you with our best possible after-sales service and useful updates.

www.bushregistration.co.uk

FREEPHONE*

0800 597 8548

Lines are open 8am - 8pm, 365 days a year. *Calls may be recorded and monitored.

Your Bush Guarantee

This product is guaranteed for twelve months from the date of original purchase. Any defect that arises due to faulty materials or workmanship will be repaired free of charge (or if applicable the product will be replaced or the purchase price refunded) where possible during this period by the dealer from who your purchased the unit.

The guarantee is subject to the following provisions:

- The guarantee does not cover accidental damage, misuse, cabinet parts, knobs or consumable items.
- The product must be correctly installed and operated in accordance with the instructions contained in the manual.
- It must be used solely for domestic purposes. The guarantee will be rendered invalid if the product is re-sold or has been damaged by inexpert repair.
- Specifications are subject to change without notice.
- Bush disclaim any liability for loss or damage arising from the breakdown of the product.
- This guarantee is in addition to and does not diminish your statutory or legal rights.

Important Data Protection Information

To find out how we and Domestic & General Insurance Plc use your data please refer to the guarantee registration material or visit www.bushregistrations.co.uk

Guarantor: Argos Limited - 489 - 499 Avebury Blvd. - Milton Keynes - MK9 2NW

or online at www.bush-support.co.uk If you still require further assistance, call one of our experts on **01759 487838**

BUSH



Contact:

www.argos-support.co.uk

Helpline: 01759 487838