

BUSH

Instruction manual

Built-In Freezer

MBI55177FRZ

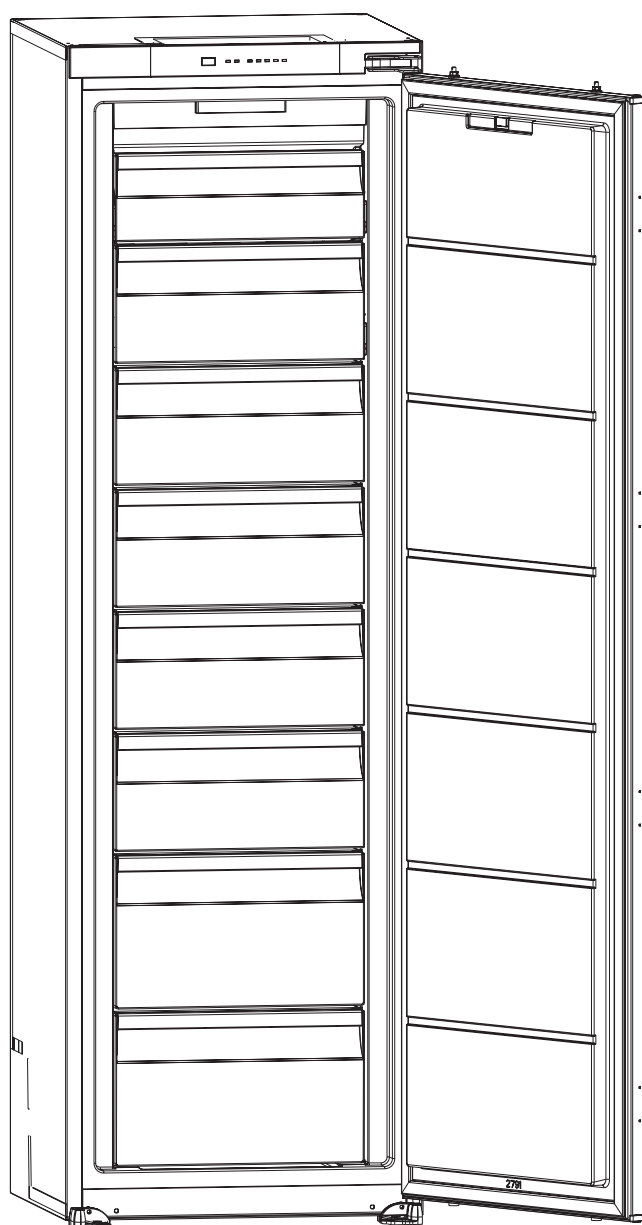

You'll soon be enjoying your new Built-In Freezer. It all begins here, with your instructions. Don't worry, there's nothing too technical coming up. Just simple, step-by-step guidance to get you up and running quickly. Sound good? Then let's get started.

Help and Guidance

We're here to help you get the most from your Built-In Freezer. Should you require any guidance, a simple solution can often be found online at:

www.bush-support.com

If you still require further assistance, call one of our experts on 0345 257 7271.

If you require any technical guidance or find that your product is not operating as intended, a simple solution can often be found in the Troubleshooting section of these instructions.

Contents

1 Safety information

Safety information 6

2 Getting to know your Built-in Larder

Ready? Let's begin 10

Product features 11

3 Installing your Built-in Larder

Installation Warnings 14

Electrical Information (for UK Type Plug) 14

During Usage 15

Shipment and Repositioning 16

Transport and Changing Position 16

4 Functions

Information on No-Frost Technology 18

5 Using your Built-in Larder

Display and Control Panel 20

Operating your Freezer 20

Temperature Adjustment Warnings 21

Accessories 21

Food Storage 22

5 Care and maintenance

Cleaning and Maintenance 26

Defrosting 26

Technical Specification 27

7 Product support





Before Calling After-Sales Service 30

Tips for Energy Saving 31

Help and assistance 32

Disposal 33

Guarantee 34

Icon	Type	Meaning
	WARNING	Serious injury or death risk
	RISK OF ELECTRIC SHOCK	Dangerous voltage risk
	FIRE	Warning; Risk of fire / flammable materials
	CAUTION	Injury or property damage risk
	IMPORTANT	Operating the system correctly

If you require any technical guidance or find that your product is not operating as intended, a simple solution can often be found in the Troubleshooting section of these instructions.

Safety Information

1





Safety information

Important - Please read these instructions fully before installing or operating

Safety Instructions

General Safety Warnings

Read this user manual carefully.

⚠ WARNING: Keep ventilation openings, in the appliance enclosure or in the built-in structure, clear of obstruction.

⚠ WARNING: Do not use mechanical devices or other means to accelerate the defrosting process, other than those recommended by the manufacturer.

⚠ WARNING: Do not use electrical appliances inside the food storage compartments of the appliance, unless they are of the type recommended by the manufacturer.

⚠ WARNING: Do not damage the refrigerant circuit.

⚠ WARNING: When positioning the appliance, ensure the supply cord is not trapped or damaged.

⚠ WARNING: Do not locate multiple portable socket-outlets or portable power supplies at the rear of the appliance.

⚠ WARNING: In order to avoid any hazards resulting from the instability of the appliance, it must be fixed in accordance with the following instructions:

⚠ If your appliance uses R600a as a refrigerant (this information will be provided on the label of the cooler) you should take care during transportation and installation to prevent the cooler elements from being damaged. R600a is an

environmentally friendly and natural gas, but it is explosive. In the event of a leak due to damage of the cooler elements, move your freezer away from open flames or heat sources and ventilate the room where the appliance is located for a few minutes.

- While carrying and positioning the freezer, do not damage the cooler gas circuit.
- Do not store explosive substances such as aerosol cans with a flammable propellant in this appliance.
- This appliance is intended to be used in household and domestic applications such as:
 - staff kitchen areas in shops, offices and other working environments.
 - farm houses and by clients in hotels, motels and other residential type environments.
 - bed and breakfast type environments;
 - catering and similar non-retail applications.
- If the socket does not match the refrigerator plug, it must be replaced by the manufacturer, a service agent or similarly qualified persons in order to avoid a hazard.
- A specially grounded plug has been connected to the power cable of your refrigerator. This plug should be used with a specially grounded socket of 13 amperes. If there is no such socket in your house, please have one installed by an authorised electrician.



Safety information

Important - Please read these instructions fully before installing or operating

- This appliance can be used by children aged from 8 years and above and persons with reduced physical, sensory or mental capabilities or lack of experience and knowledge if they have been given supervision or instruction concerning use of the appliance in a safe way and understand the hazards involved. Children shall not play with the appliance. Cleaning and user maintenance shall not be made by children without supervision.
- Children aged from 3 to 8 years are allowed to load and unload refrigerating appliances. Children are not expected to perform cleaning or user maintenance of the appliance, very young children (0-3 years old) are not expected to use appliances, young children (3-8 years old) are not expected to use appliances safely unless continuous supervision is given, older children (8-14 years old) and vulnerable people can use appliances safely after they have been given appropriate supervision or instruction concerning use of the appliance. Very vulnerable people are not expected to use appliances safely unless continuous supervision is given.
- If the supply cord is damaged, it must be replaced by the manufacturer, an authorised service agent or similar qualified persons, in order to avoid a hazard.
- This appliance is not intended for use at altitudes exceeding 2000 m.

To avoid contamination of food, please respect the following instructions:

- Opening the door for long periods can cause a significant increase of the temperature in the compartments of the appliance.
- Clean regularly surfaces that can come in contact with food and accessible drainage systems.
- Store raw meat and fish in suitable containers in the refrigerator, so that it is not in contact with or drip onto other food.
- Two-star frozen-food compartments are suitable for storing pre-frozen food, storing or making ice cream and making ice cubes.
- One-, two- and three-star compartments are not suitable for the freezing of fresh food.
- If the refrigerating appliance is left empty for long periods, switch off, defrost, clean, dry, and leave the door open to prevent mould developing within the appliance.



If you require any technical guidance or find that your product is not operating as intended, a simple solution can often be found in the Troubleshooting section of these instructions.

Getting to know your
Built-In Freezer

2



Getting to know your Built-In Freezer

You'll be up and running in no time

Ready? Let's begin...

Please read these instructions carefully. They contain important information which will help you get the best from your Built-In Freezer and ensure safe and correct installation and operation.

If you require any further assistance, our technical experts are happy to help. For full details, refer to the product support section at the end of these instructions.

Getting to know your Built-In Freezer

You'll be up and running in no time

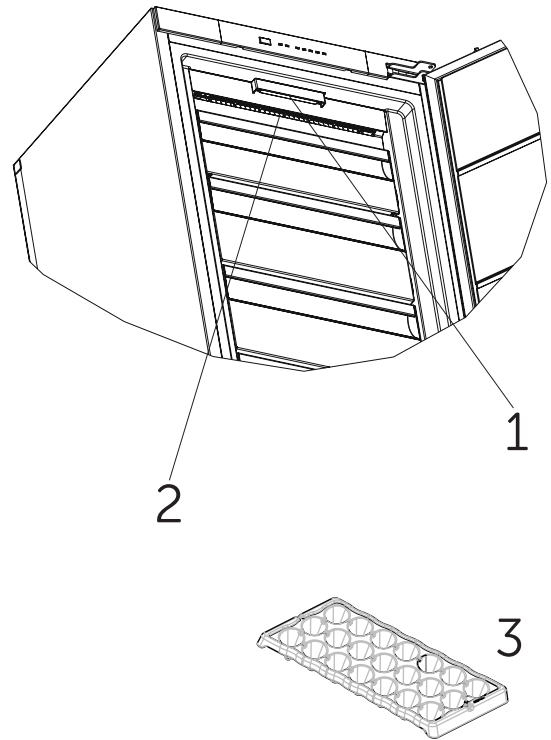
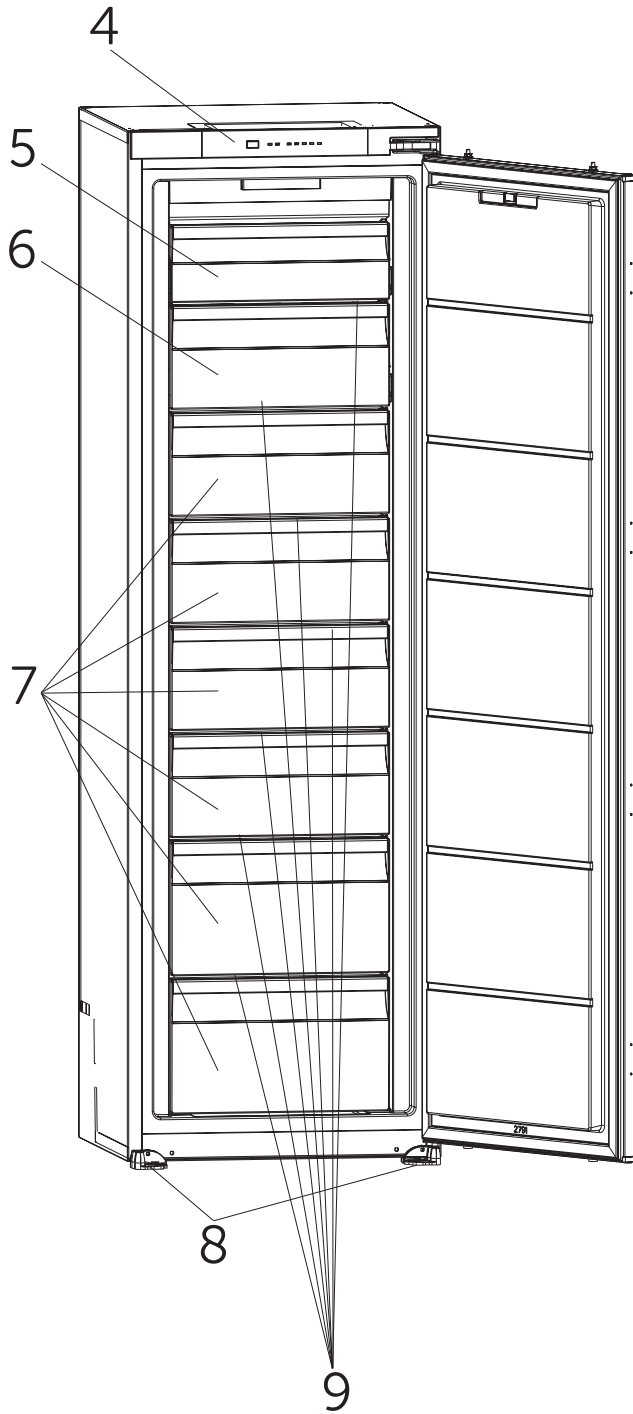

- 1. Freezer LED strip
- 2. No Frost air circulation system
- 3. Ice tray x 1
- 4. Control panel
- 5. Freezer upper room flap
- 6. Freezer bottom room flap
- 7. Freezer drawers x 6
- 8. Left & Right stays
- 9. Freezer glass shelves x 7



If you require any technical guidance or find that your product is not operating as intended, a simple solution can often be found in the Troubleshooting section of these instructions.

Installing your Built-In Freezer

3



Installing your Built-In Freezer

Bringing it all together

Installation warnings

Before using your fridge freezer for the first time, please pay attention to the following points:

- The operating voltage for your freezer is 220-240 V at 50Hz.
 - The plug must be accessible after installation.
 - Your freezer may have an odour when it is operated for the first time. This is normal and the odour will fade when your freezer starts to cool.
 - Before connecting your freezer, ensure that the information on the data plate (voltage and connected load) matches that of the mains electricity supply. If in doubt, consult a qualified electrician.
 - Insert the plug into a socket with an efficient ground connection. If the socket has no ground contact or the plug does not match, we recommend you consult a qualified electrician for assistance.
 - The appliance must be connected with a properly installed fused socket. The power supply (AC) and voltage at the operating point must match with the details on the name plate of the appliance (the name plate is located on the inside left of the appliance).
 - We do not accept responsibility for any damages that occur due to ungrounded usage.
 - Place your freezer where it will not be exposed to direct sunlight.
 - Your freezer must never be used outdoors or exposed to rain.
 - Your appliance must be at least 50 cm away from stoves, gas ovens and heater cores, and at least 5 cm away from electrical ovens.
 - If your freezer is placed next to a deep freezer, there must be at least 2 cm between them to prevent humidity forming on the outer surface.
 - Do not cover the body or top of freezer with lace. This will affect the performance of your freezer.
- Clearance of at least 150 mm is required at the top of your appliance. Do not place anything on top of your appliance.
 - Do not place heavy items on the appliance.
 - Clean the appliance thoroughly before use (see Cleaning and Maintenance).
 - The installation procedure into a kitchen unit is given in the installation manual. This product is intended to be used in proper kitchen units only.
 - Before using your freezer, wipe all parts with a solution of warm water and a teaspoon of sodium bicarbonate. Then, rinse with clean water and dry. Return all parts to the freezer after cleaning.

Electrical information (For UK type plug)

⚠ Warning! This appliance must be earthed.

The mains lead of this appliance has been fitted with a specially earthed plug.

⚠ ⚡ Important: Do not use the appliance without the fuse cover in position. Should the fuse need to be replaced, it must be replaced with a 13A fuse, ASTA approved to BS1362.

The plug must be used with a specially earthed socket of 13 amperes. If there is no such socket in your house, please have one installed by an authorised electrician.

The mains lead of this appliance has been fitted with a BS 1363A 13A fused plug. To change a fuse in this type of plug, follow the steps below:

1. Remove the fuse cover and fuse.
2. Fit replacement 13A fuse, ASTA approved to BS 1362 type, into the fuse cover.
3. Replace fuse cover.

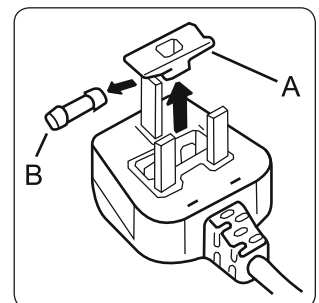

Installing your Built-In Freezer

Bringing it all together

During Usage

- Do not connect your freezer to the mains electricity supply using an extension lead.
- Do not use damaged, torn or old plugs.
- Do not pull, bend or damage the cord.
- Do not use plug adapter.
- This appliance is designed for use by adults. Do not allow children to play with the appliance or hang off the door.
- Never touch the power cord/plug with wet hands. This may cause a short circuit or electric shock.
- Do not place glass bottles or cans in the ice-making compartment as they will burst when the contents freeze.
- Do not place explosive or flammable material in your freezer.
- When removing ice from the ice-making compartment, do not touch it. Ice may cause frost burns and/or cuts.
- Do not touch frozen goods with wet hands. Do not eat ice-cream or ice cubes immediately after they are removed from the ice-making compartment.
- Do not re-freeze thawed frozen food. This may cause health issues such as food poisoning.

Old and Out-of-order Fridges

- If your old fridge or freezer has a lock, break or remove the lock before discarding it, because children may get trapped inside it and may cause an accident.
- Old fridges and freezers contain isolation material and refrigerant with CFC. Therefore, take care not to harm environment when you are discarding your old fridges.

CE Declaration of conformity

We declare that our products meet the applicable European Directives, Decisions and Regulations and the requirements listed in the standards referenced.

Disposal of your old appliance

The symbol on the product or on its packaging indicates that this product may not be treated as household waste. Instead it shall be handed over to the applicable collection point for the recycling of electrical and electronic equipment. By ensuring this product is disposed of correctly, you will help prevent potential negative consequences for the environment and human health, which could otherwise be caused by inappropriate waste handling of this product. For more detailed information about recycling of this product, please contact your local city office, your household waste disposal service or the shop where you purchased the product.

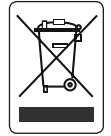

Packaging and the Environment

Packaging materials protect your machine from damage that may occur during transportation. The packaging materials are environmentally friendly as they are recyclable. The use of recycled material reduces raw material consumption and therefore decreases waste production.



Notes:

- Please read the instruction manual carefully before installing and using your appliance. We are not responsible for the damage occurred due to misuse.
- Follow all instructions on your appliance and instruction manual, and keep this manual in a safe place to resolve the problems that may occur in the future.
- This appliance is produced to be used in homes and it can only be used in domestic environments and for the specified purposes. It is not suitable for commercial or common use. Such use will cause the guarantee of the appliance to be cancelled and our company will not be responsible for any losses incurred.
- This appliance is produced to be used in houses and it is only suitable for cooling / storing foods. It is not suitable for commercial or common use and/or for storing substances except for food. Our company is not responsible for any losses incurred by inappropriate usage of the appliance.

Installing your Built-In Freezer

Bringing it all together

Shipment and Repositioning

Transportation and Changing Positioning

- The original packaging and foam may be kept for re-transportation (optional).
- Fasten your appliance with thick packaging, bands or strong cords and follow the instructions for transportation on the packaging.
- Remove all movable parts (drawers, Ice trays and so on) or fix them into the appliance against shocks using bands when re-positioning or transporting.

 Always carry your appliance in the upright position.

Functions 4



Functions

Simple everyday use

Information on No-Frost technology

No-frost freezers differ from other static freezers in their operating principle.

In normal freezers, the humidity entering the freezer due to opening the door and the humidity inherent in the food causes freezing in the freezer compartment. To defrost the frost and ice in the freezer compartment, you are periodically required to turn off the freezer, place the food that needs to be kept frozen in a separately cooled container and remove the ice gathered in the freezer compartment.

The situation is completely different in no-frost freezers. Dry and cold air is blown into the freezer compartment homogeneously and evenly from several points via a blower fan. Cold air dispersed homogeneously and evenly between the shelves cools all of your food equally and uniformly, thus preventing humidity and freezing.

Therefore your no-frost freezer allows you ease of use, in addition to its huge capacity and stylish appearance.

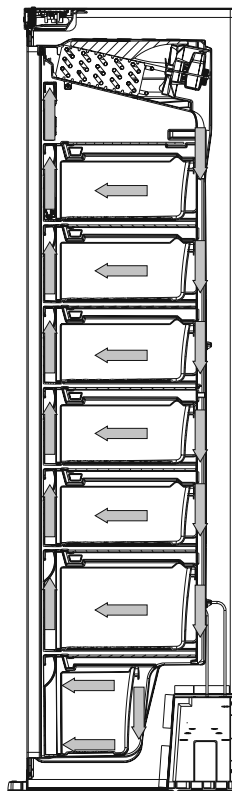

Using your Built-In Freezer

5



Using your Built-In Freezer

Getting the most from your appliance

Display and Control Panel

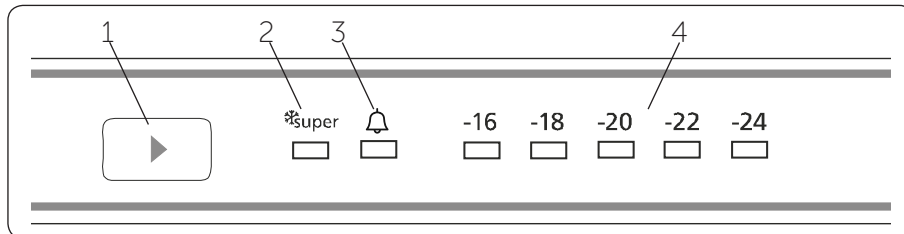

Using the Control Panel

1. Freezer temperature set button
2. Super freeze symbol (Super freeze LED)
3. Alarm symbol (Alarm LED)
4. Freezer adjusted temperature indicator

Operating your Freezer

Freezer Temperature Set Button

This button allows setting temperature of the freezer. In order to set values for freezer partition, press this button. Use this button also to activate super freeze mode.

Alarm symbol (Alarm LED)

In case of a problem within the freezer, the alarm led will release red light.

Super Freezer Mode

When Would It Be Used?

- To freeze huge quantities of food.
- To freeze fast food.
- To freeze food quickly.
- To store seasonal food for a long time.

How To Use?

- Press temperature set button until super freezing light comes on.
- Super freezing led will light during this mode.
- Maximum amount of fresh food (in kilograms) to be frozen within 24 hours is shown on the appliance label.
- For optimal appliance performance in maximum freezer capacity, set the appliance to active super freeze mode 24 hours before you put the fresh food into the freezer.

During This Mode:

If you press temperature set button, the mode will be cancelled and the setting will be restored from -16.

- Super freeze mode will automatically cancel after 24 hours, depending on the environmental temperature or when the freezer sensor reaches a sufficiently low temperature.

Freezer Temperature Settings

- The initial temperature of the setting display is -18 °C.
- Press freezer setting button once.
- Every time you press the button, the setting temperature will decrease. (-16 °C, -18 °C, -20 °C,.. super freezing)
- If you press freezer setting button until super freezer symbol is displayed on freezer.
- Settings display and you do not press any button within the following 3 seconds, super freezing will blink.
- If you keep on pressing, it will restart from last value.

Recommended Temperature Values for Freezer

When to adjust	Inner Temperature
For minimum freezing capacity	-16 °C, -18 °C
In normal usage	-18 °C, -20 °C, -22 °C
For maximum freezing capacity	-24 °C

Using your Built-In Freezer

Getting the most from your appliance

Temperature Adjustment Warnings

- It is not recommended that you operate your freezer in environments colder than 10°C in terms of its efficiency.
- Do not start another adjustment while you are already making an adjustment.
- Temperature adjustments should be made according to the frequency of door openings, the quantity of food kept inside the freezer and the ambient temperature in the location of your freezer.
- In order to allow your freezer to reach the operating temperature after being connected to mains, do not open the door frequently or place large quantities of food in the freezer. Please note that, depending on the ambient temperature, it may take 24 hours for your freezer to reach the operating temperature.
- A 5 minute delay function is applied to prevent damage to the compressor of your freezer when connecting or disconnecting to mains, or when an energy breakdown occurs. Your freezer will begin to operate normally after 5 minutes.
- Your appliance is designed to operate in the ambient temperature (T/SN = 10°C - 43°C) intervals stated in the standards, according to the climate class displayed on the information label. We do not recommend operating your appliance out of the stated temperature limits in terms of cooling effectiveness.

Climate Class	Ambient Temperature °C
T	Between 16 and 43 (°C)
ST	Between 16 and 38 (°C)
N	Between 16 and 32 (°C)
SN	Between 10 and 32 (°C)

Accessories

The Icematic

- Pull the lever towards you and remove the ice maker tray
- Fill with water to the marked level
- Hold the left end of the lever and set the ice-tray on the icebox
- When ice cubes have formed, twist the lever to drop the ice cubes into the icebox.

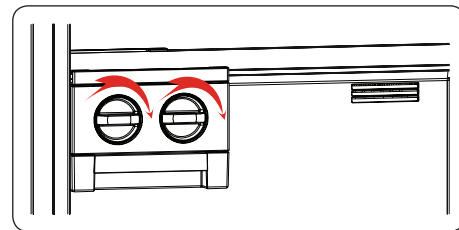

Note:

- Do not fill the icebox with water in order to make ice. It can be broken.
- The movement of the ice maker may be difficult while the refrigerator is running. In such a case should be cleaned by removing the glass shelves.

Removing the icemaker

- Take out of the freezer glass shelves
- Remove the icemaker by dragging left or right on the shelf.

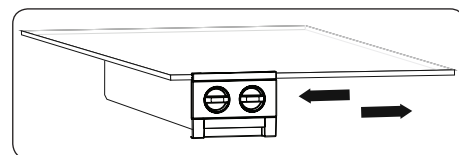

You can remove the icemaker to use a larger volume of the freezer compartment.

Visual and text descriptions in the accessories section may vary according to the model of your appliance.

Using your Built-In Freezer

Getting the most from your appliance

Food Storage

- The freezer is used for storing frozen food, freezing fresh food, and making ice cubes.
- For freezing fresh food; wrap and seal fresh food properly, that is the packaging should be air tight and shouldn't leak. Special freezer bags, aluminum foil polythene bags and plastic containers are ideal.
- Do not store fresh food next to frozen food as it can thaw the frozen food.
- Before freezing fresh food, divide it into portions that can be consumed in one sitting.
- Consume thawed frozen food within a short period of time after defrosting
- Never place warm food in the freezer compartment as it will thaw the frozen food.
- Always follow the manufacturer's instructions on food packaging when storing frozen food. If no information is provided food, should not be stored for more than 3 months from the date of purchase.
- When purchasing frozen food, make sure that it has been stored under appropriate conditions and that the packaging is not damaged.
- Frozen food should be transported in appropriate containers and placed in the freezer as soon as possible.
- Do not purchase frozen food if the packaging shows signs of humidity and abnormal swelling. It is probable that it has been stored at an unsuitable temperature and that the contents have deteriorated.
- The storage life of frozen food depends on the room temperature, the thermostat setting, how often the door is opened, the type of food, and the length of time required to transport the product from the shop to your home. Always follow the instructions printed on the packaging and never exceed the maximum storage life indicated.
- The maximum amount of fresh food (in kg) that can be frozen in 24 hours is indicated on the appliance label.

- Use the fast freezing shelf to freeze home cooking (and any other food which needs to be frozen quickly) more quickly because of the freezing shelf's greater freezing power. Fast freezing shelf is the bottom drawer of the freezer compartment.

NOTE: If you attempt to open the freezer door immediately after closing it, you will find that it will not open easily. This is normal. Once equilibrium has been reached, the door will open easily.

Important note:

- Never refreeze thawed frozen food.
- The taste of some spices found in cooked dishes (anise, basilica, watercress, vinegar, assorted spices, ginger, garlic, onion, mustard, thyme, marjoram, black pepper, etc.) changes and they assume a strong taste when they are stored for a long period of time. Therefore, add small amounts of spices to food to be frozen, or the desired spice should be added after the food has thawed.
- The storage time of food is dependent on the type of oil used. Suitable oils are margarine, calf fat, olive oil and butter. Unsuitable oils are peanut oil and pig fat.
- Food in liquid form should be frozen in plastic cups and other food should be frozen in plastic folios or bags.

Using your Built-In Freezer

Getting the most from your appliance

 The table below is a quick guide to show you the most efficient way to store the major food groups in your freezer compartment.

Meat and fish	Preparation	Maximum storage time (months)
Steak	Wrap in foil	6 - 8
Lamb meat	Wrap in foil	6 - 8
Veal roast	Wrap in foil	6 - 8
Veal cubes	In small pieces	6 - 8
Lamb cubes	In pieces	4 - 8
Minced meat	In packaging without using spices	1 - 3
Giblets (pieces)	In pieces	1 - 3
Bologna sausage/salami	Should be kept packaged even if it has a membrane	
Chicken and turkey	Wrap in foil	4 - 6
Goose and duck	Wrap in foil	4 - 6
Deer, rabbit, wild boar	In 2.5 kg portions or as fillets	6 - 8
Freshwater fish (Salmon, Carp, Crane, Catfish)	After cleaning the bowels and scales of the fish, wash and dry it. If necessary, remove the tail and head.	2
Lean fish (Bass, Turbot, Flounder)		4
Fatty fishes (Tuna, Mackerel, Bluefish, Anchovy)		2 - 4
Shellfish	Clean and in a bag	4 - 6
Caviar	In its packaging, or in an aluminium or plastic container	2 - 3
Snails	In salty water, or in an aluminium or plastic container	3

 NOTE: Thawed frozen meat should be cooked as fresh meat. If the meat is not cooked after defrosting, it must not be re-frozen.

Vegetables and Fruits	Preparation	Maximum storage time (months)
String beans and beans	Wash, cut into small pieces and boil in water	10 - 13
Beans	Hull, wash and boil in water	12
Cabbage	Clean and boil in water	6 - 8
Carrot	Clean, cut into slices and boil in water	12
Pepper	Cut the stem, cut into two pieces, remove the core and boil in water	8 - 10
Spinach	Wash and boil in water	6 - 9
Cauliflower	Remove the leaves, cut the heart into pieces and leave it in water with a little lemon juice for a while	10 - 12
Eggplant	Cut into pieces of 2cm after washing	10 - 12

Using your Built-In Freezer

Getting the most from your appliance

Vegetables and Fruits	Preparation	Maximum storage time (months)
Corn	Clean and pack with its stem or as sweet corn	12
Apple and pear	Peel and slice	8 - 10
Apricot and Peach	Cut into two pieces and remove the stone	4 - 6
Strawberry and Blackberry	Wash and hull	8 - 12
Cooked fruits	Add 10 % of sugar to the container	12
Plum, cherry, sourberry	Wash and hull the stems	8 - 12

	Maximum storage time (months)	Thawing time at room temperature (hours)	Thawing time in oven (minutes)
Bread	4 - 6	2 - 3	4-5 (220-225 °C)
Biscuits	3 - 6	1 - 1,5	5-8 (190-200 °C)
Pastry	1 - 3	2 - 3	5-10 (200-225 °C)
Pie	1 - 1,5	3 - 4	5-8 (190-200 °C)
Phyllo dough	2 - 3	1 - 1,5	5-8 (190-200 °C)
Pizza	2 - 3	2 - 4	15-20 (200 °C)

Dairy products	Preparation	Maximum storage time (months)	Storage conditions
Packet (Homogenized) Milk	In its own packet	2 - 3	Pure Milk – in its own packet
Cheese - excluding white cheese	In slices	6 - 8	Original packaging may be used for short-term storage. Keep wrapped in foil for longer periods.
Butter, margarine	In its packaging	6	

If you require any technical guidance or find that your product is not operating as intended, a simple solution can often be found in the Troubleshooting section of these instructions.

Care and Maintenance



6





Care and maintenance

Looking after your appliance

Cleaning and Maintenance

-  Disconnect the unit from the power supply before cleaning.
-  Do not wash your appliance by pouring water on it.
-  Do not use abrasive products, detergents or soaps for cleaning the appliance. After washing, rinse with clean water and dry carefully. When you have finished cleaning, reconnect the plug to the mains supply with dry hands.

- Make sure that no water enters the lamp housing and other electrical components.
- The appliance should be cleaned regularly using a solution of bicarbonate of soda and lukewarm water.
- Clean the accessories separately by hand with soap and water. Do not wash accessories in a dish washer.
- Clean the condenser with a brush at least twice a year. This will help you to save on energy costs and increase productivity.

  The power supply must be disconnected during cleaning.

Replacing LED Lighting

Depending on the model, one LED strip in the freezer is used to illuminate the interior of your appliance.

To replace any of the LEDs, please contact the nearest Authorised Service Centre.

 Some versions may not include freezer illumination.

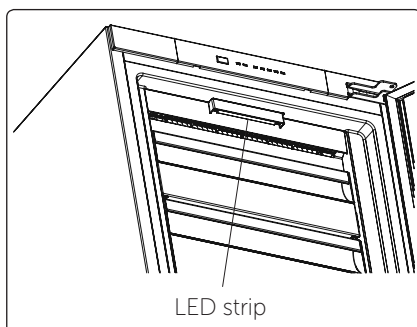

Defrosting the Freezer Compartment

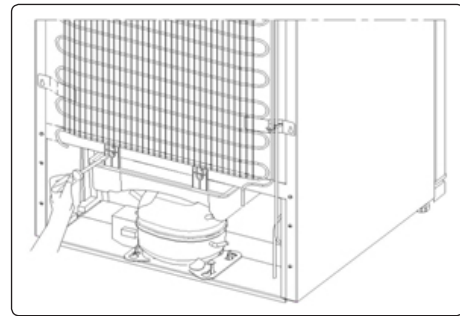

- Your appliance performs automatic defrosting. The water formed as a result of defrosting passes through the water collection spout, flows into the vaporisation container behind your appliance and evaporates there.
- Make sure you have disconnected the plug of your appliance before cleaning the vaporisation container.
- Remove the vaporisation container from its position by removing the screws as indicated. Clean it with soapy water at specific time intervals. This will prevent odours from forming.

Care and maintenance

Looking after your appliance

Technical specification

Supplier's name or trademark	BUSH
Model / Item	MBI55177FRZ
Type of appliance	BGT/SN2791E-S
Energy efficiency class	A+
Voltage	220-240V / 50 Hz
Energy consumption	0.813 kWh/24h - 297 kWh/year
Net storage volume of fresh food	-
Net storage volume of frozen food	197 lt.
Star rating of frozen food storage compartment	4 (****)
Power cut failure safe storage	9 hours (25°C)
Freezing capacity	15 Kg
Climate class	T/SN (10°C - 43°C)
Size (mm) (W x D x H)	540 x 545 x 1770
Noise	41 dB (A) re 1pW

We apologise for any inconvenience caused by minor change or inconsistencies in these instructions that may occur as a result of product improvements and development.





If you require any technical guidance or find that your product is not operating as intended, a simple solution can often be found in the Troubleshooting section of these instructions.

Product Support

7



Product support

Help is always at hand

Before Calling After-Sales Service

Errors

Your freezer will warn you if the temperatures for the freezer is at improper levels or if a problem occurs with the appliance. In case of a problem within the freezer, the alarm led will release red light.

Alarm indicator LED is turning on	MEANING	WHY	WHAT TO DO
	"Failure" Warning	There is/are some part(s) out of order or there is a failure in the cooling process. The product is plugged for the first time or a long-time power interruption for 1 hour.	Check the door is open or not and check if the product working 1 hour. If the door is not open and the product had worked 1 hour, call service for assistance as soon as possible.

If you are experiencing a problem with your freezer, please check the following before contacting the after-sales service.

Your freezer is not operating

Check if:

- There is power
- The plug is correctly placed in the socket
- The plug fuse or the mains fuse has blown
- The socket is faulty. Examine this by plugging your freezer into a working socket.

What to do if your appliance performs poorly;

Check that;

- You have not overloaded the appliance,
- The freezer temperature set to -16,
- The doors are closed perfectly,
- There is no dust on the condenser,
- There is enough place at the rear and side walls.

Your freezer is operating noisily

Normal noises

Cracking (ice cracking) noise occurs:

- During automatic defrosting
- When the appliance is cooled or warmed (due to expansion of appliance material).

Short cracking noise occurs: When the thermostat switches the compressor on/off.

Motor noise: Indicates the compressor is operating normally. The compressor may cause more noise for a short time when it is first activated.

Bubbling noise and splash occurs: Due to the flow of the refrigerant in the tubes of the system.

Water flowing noise occurs: Due to water flowing to the evaporation container. This noise is normal during defrosting.

Air blowing noise occurs: In No-Frost freezers during normal operation of the system due to the circulation of air.

The edges of the freezer in contact with the door joint are warm

Especially during summer (warm seasons), the surfaces in contact with the door joint may become warmer during the operation of the compressor, this is normal.

The door does not open or close properly

Check if:

- There is food or packaging preventing the door from closing
- The door joints are broken or torn
- Your freezer is on a level surface.

Recommendations

To stop the appliance completely, unplug from main socket (for cleaning and when the door is left open).

Product support

Help is always at hand

Tips for Saving Energy

1. Install the appliance in a cool, well-ventilated room, but not in direct sunlight and not near a heat source (such as a radiator or oven) otherwise an insulating plate should be used.
2. Allow warm food and drinks to cool before placing them inside the appliance.
3. Drinks or other liquids should be covered when inside the appliance. If left uncovered, the humidity inside the appliance will increase, therefore the appliance uses more energy. Keeping drinks and other liquids covered helps preserve their smell and taste.
4. Avoid keeping the doors open for long periods and opening the doors too frequently as warm air will enter the appliance and cause the compressor to switch on unnecessarily often.
5. The door gasket must be clean and pliable. In case of wear, if your gasket is detachable, replace the gasket. If not detachable, you have to replace the door.

Product support

Help is always at hand

Help and assistance

If you require any technical guidance or find that your Built-In Freezer is not operating as intended, a simple solution can often be found in the **Troubleshooting** section of these instructions or online at www.bush-support.com

If you still require further assistance, call one of our experts on **0345 257 7271***. To help give us give you a fast and efficient service please have the following information ready:

Model Ref.	<input type="text"/>	You can find these on the rating plate - a small information panel (usually a sticker or metal plate) on the rear of your appliance
Serial number	<input type="text"/>	
Date of purchase	<input type="text"/>	This will be shown on your receipt

Local call rates applies*

Lines open 8am-7pm Monday to Saturday and 10am-4pm Sunday.

*Calls to Argos enquiry lines may attract a charge and set up fee from residential lines depending on your call plan/tariff . Mobile and other providers costs may vary, see www.bt.com/pricing for details.

For Security and training purposes, telephone calls to and from customer service centres maybe recorded and monitored. Calls from Republic of Ireland will attract international call charges.

Product support

Help is always at hand

Disposal

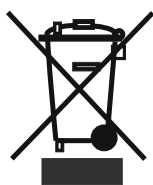

- The symbol on the product or on its packaging indicates that this product may not be treated as household waste. Instead it shall be handed over to the applicable collection point for the recycling of electrical and electronic equipment.
- By ensuring this product is disposed of correctly, you will help prevent potential negative consequences for the environment and human health, which could otherwise be caused by inappropriate waste handling of this product.
- For more detailed information about recycling of this product, please contact your local city office, your household waste disposal service or the shop where you purchased the product.

If you are creating instructions, you may find the following links helpful:

www.environmentlaw.org.uk

Product support

Help is always at hand



Call us now and activate your 12 month guarantee

Thank you for choosing Bush. Your new product is guaranteed against faults and breakdowns for 12 months. Don't forget to register it with us today so we can provide you with our best possible after-sales service and useful updates.

www.bushregistration.co.uk

FREEPHONE*

0800 597 8548

Lines are open 8am - 8pm, 365 days a year. *Calls may be recorded and monitored.

Your Bush Guarantee

This product is guaranteed for twelve months from the date of original purchase. Any defect that arises due to faulty materials or workmanship will be repaired free of charge (or if applicable the product will be replaced or the purchase price refunded) where possible during this period by the dealer from who your purchased the unit.

The guarantee is subject to the following provisions:

- The guarantee does not cover accidental damage, misuse, cabinet parts, knobs or consumable items.
- The product must be correctly installed and operated in accordance with the instructions contained in the manual.
- It must be used solely for domestic purposes. The guarantee will be rendered invalid if the product is re-sold or has been damaged by inexpert repair.
- Specifications are subject to change without notice.
- Bush disclaim any liability for loss or damage arising from the breakdown of the product.
- This guarantee is in addition to and does not diminish your statutory or legal rights.

Important Data Protection Information

If you provide us with information about another person, you confirm that they have appointed you to act for them, to consent to the processing of their personal data including sensitive personal data and that you have informed them of our identity and the purposes (as set out in the Important Data Privacy notice displayed overleaf) for which their personal data will be processed.

You are entitled to ask for a copy of the information we hold about you (for which we may charge a small fee) and to have any inaccuracies in your information corrected.

For quality control and training purposes, we may monitor or record your communications with us.

If your personal details change, if you change your mind about any of your marketing preferences or if you have any queries about how we use your information, please let us know by contacting our Data Protection Officer, Domestic & General, Leicester House 17 Leicester Street, Bedworth, Warwickshire CV12 8JP.

Guarantor: Argos Limited - 489 - 499 Avebury Blvd. - Milton Keynes - MK9 2NW

If you require any technical guidance or find that your product is not operating as intended, a simple solution can often be found in the Troubleshooting section of these instructions.

Product support

Help is always at hand

Call us now and activate your 12 month guarantee

Thank you for choosing Bush. Your new product is guaranteed against faults and breakdowns for 12 months. Don't forget to register it with us today so we can provide you with our best possible after-sales service and useful updates.

www.bushregistration.co.uk

FREEPHONE*

0800 597 8548

Lines are open 8am - 8pm, 365 days a year. *Calls may be recorded and monitored

Your Bush Guarantee

This product is guaranteed for twelve months from the date of original purchase. Any defect that arises due to faulty materials or workmanship will be repaired free of charge (or if applicable the product will be replaced or the purchase price refunded) where possible during this period by the dealer from who your purchased the unit.

The guarantee is subject to the following provisions:

- The guarantee does not cover accidental damage, misuse, cabinet parts, knobs or consumable items.
- The product must be correctly installed and operated in accordance with the instructions contained in the manual.
- It must be used solely for domestic purposes. The guarantee will be rendered invalid if the product is re-sold or has been damaged by inexpert repair.
- Specifications are subject to change without notice.
- Bush disclaim any liability for loss or damage arising from the breakdown of the product.
- This guarantee is in addition to and does not diminish your statutory or legal rights.

Important Data Protection Information

To find out how we and Domestic & General Insurance Plc use your data please refer to the guarantee registration material or visit www.bushregistrations.co.uk.

Guarantor: Argos Limited - 489 - 499 Avebury Blvd. - Milton Keynes - MK9 2NW

or online at www.bush-support.com If you still require further assistance, call one of our experts on 0345 257 7271.

BUSH

Contact:

www.bush-support.com

Helpline: 0345 257 7271