

---

**morphy richards®**

intellisteam

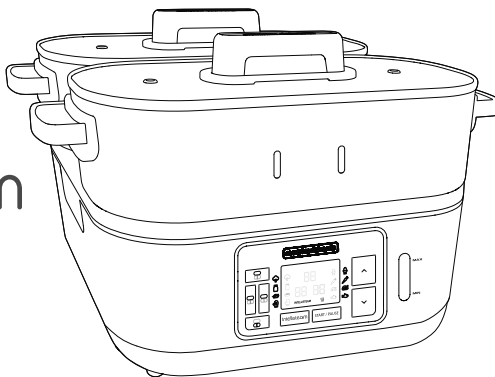

**Intellisteam**

Please read and keep these instructions

AUS



---

[www.morphyrichards.com](http://www.morphyrichards.com)

---



## Health & Safety

---

The use of any electrical appliance requires the following common sense safety rules.  
Please read these instructions carefully before using the product.

- This appliance is not intended for use by persons (including children) with reduced physical, sensory or mental capabilities, or lack of experience and knowledge, unless they have been given supervision or instruction concerning use of the appliance by a person responsible for their safety.
- Children should be supervised to ensure that they do not play with the appliance.
- Cleaning and user maintenance shall not be made by children.
- For care and cleaning, refer to 'Care and Cleaning' section.
- **WARNING: Misuse of appliance could cause personal injury.**
- The appliance has a heating element which is subject to residual heat after use.
- Keep the appliance and cord out of the reach of children.
- If the supply cable is damaged, it must be replaced by the manufacturer, its service agent or similarly qualified persons in order to avoid a hazard.
- This appliance is intended to be used in household and similar applications such as: farm houses, by clients in hotels, motels and other residential type environments; bed and breakfast type environments. It is not suitable for use in staff kitchen areas in shops, offices and other working environments.

---

## Location

- Do not use outdoors or near water.
- Do not place directly under kitchen wall cupboards when in use, as it produces large amounts of steam. Avoid reaching over the steamer when in use.

## Mains cable

- The mains cable should reach from the socket to the base unit without straining the connections.
- Do not let the cable hang over the edge of the table or counter and keep it away from any hot surfaces.
- Do not let the cable run across an open space e.g. between a low socket and table.
- The supply cord should be regularly examined for signs of damage, and if the cord is damaged, the appliance must not be used.

## Personal safety

- Do not touch hot surfaces. Use oven gloves or a cloth when removing the lid or handling hot containers as hot steam will escape.
- **WARNING: To protect against fire, electric shock and personal injury, do not immerse cord, plugs, or appliance in water or other liquid.**
- **WARNING: Extreme caution must be used when moving the steamer when containing hot food, water, or other hot liquids.**
- The temperature of accessible surfaces may be high when the appliance is operating.
- Appliances must not be immersed.
- Unplug from the socket when not in use, before putting on or taking off attachments, and before cleaning.
- Do not operate any appliance with a damaged lead or plug, or after an appliance has malfunctioned, or has been dropped or damaged in any way.
- Do not fill above the maximum level. If the steamer is over-filled, boiling water may be ejected which can scald.

## Other safety considerations

- Do not use attachments or tools not recommended by Morphy Richards as this may cause fire, electric shock or injury.
- To open, tilt the lid to direct steam away from you.
- Do not use any steamer parts in a microwave or on any cooking/heated surfaces.
- Do not place on or near a hot gas or electric burner, or in a heated oven.
- Do not switch the steamer on unless it contains at least 1 cup of water, otherwise the steamer may be damaged.
- Always make sure the water does not fall below the minimum level.

## Treating scalds

- Run cold water over the affected area immediately. Do not stop to remove clothing, get medical help quickly.

## Electrical requirements

Check that the voltage on the rating plate of your appliance corresponds with your house electricity supply which must be A.C. (Alternating Current).

Should the fuse in the mains plug require changing, a 13 amp BS1362 fuse must be fitted.

**WARNING: This appliance must be earthed.**

AUS

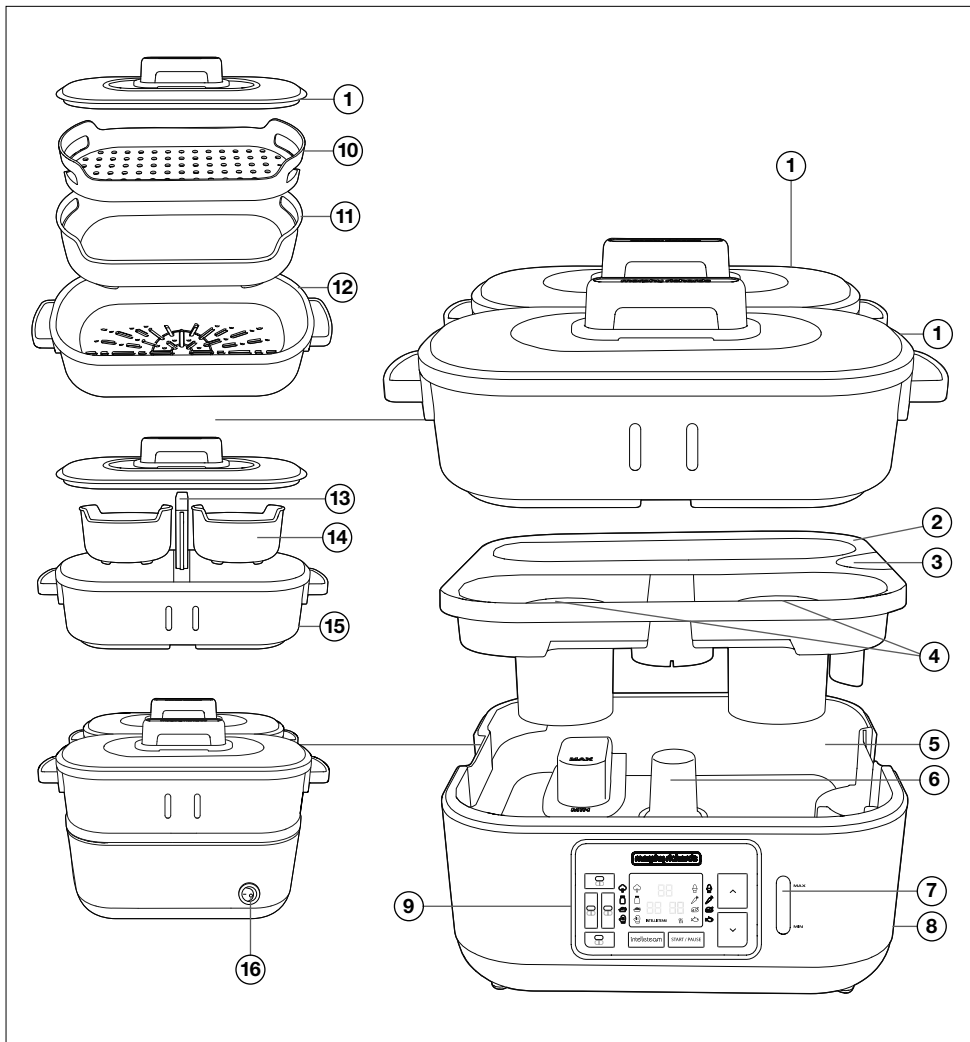

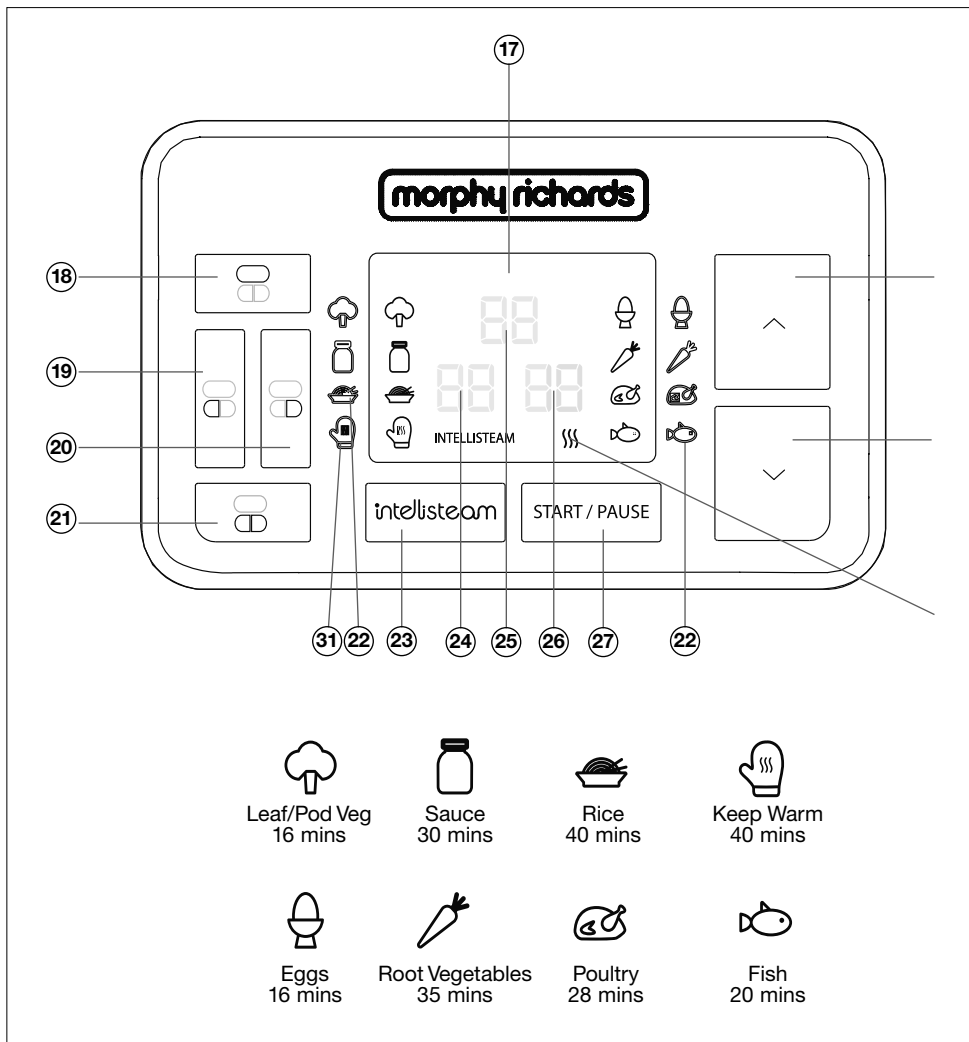

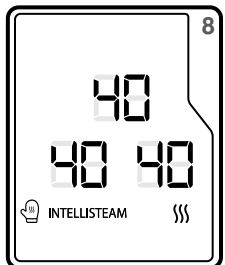
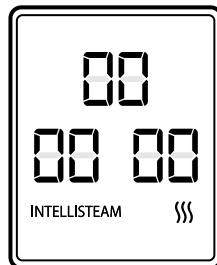
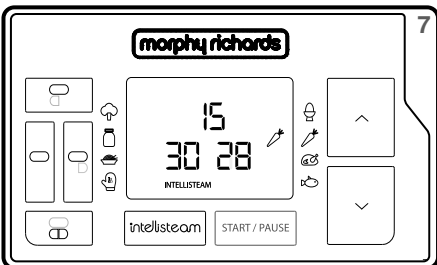
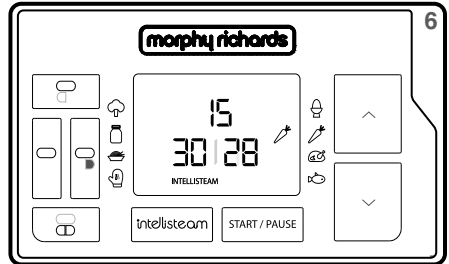
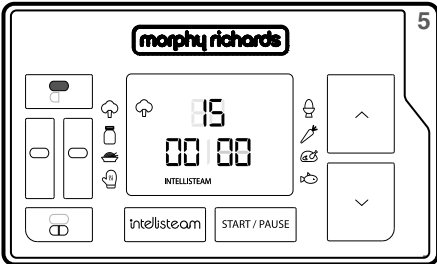
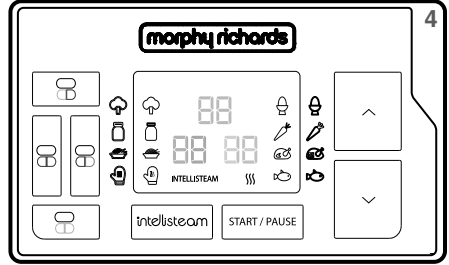
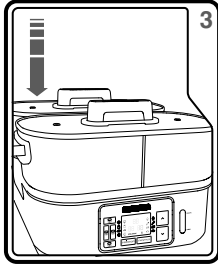
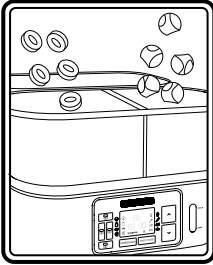
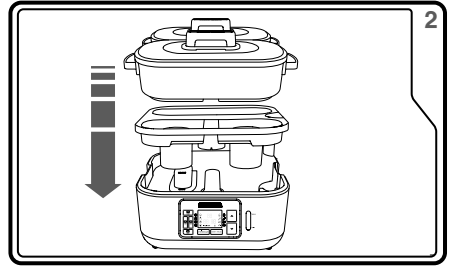
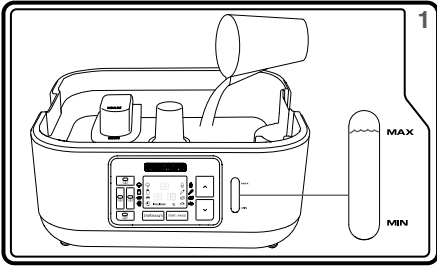

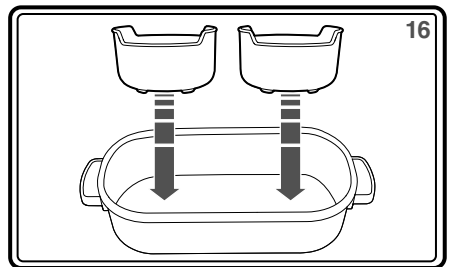
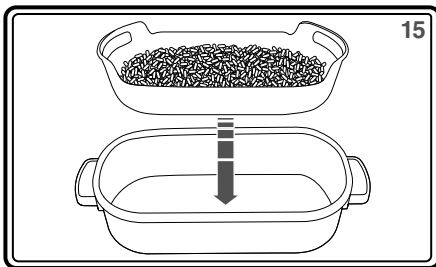
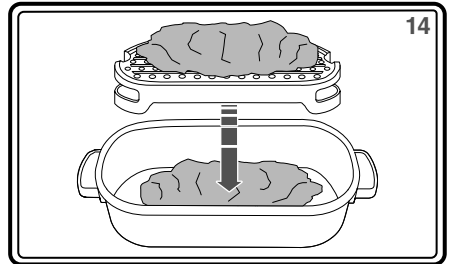
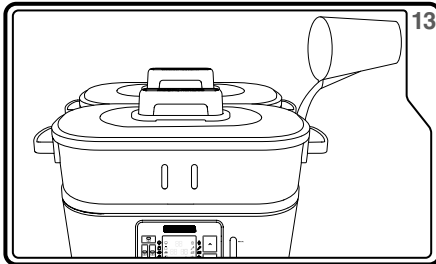
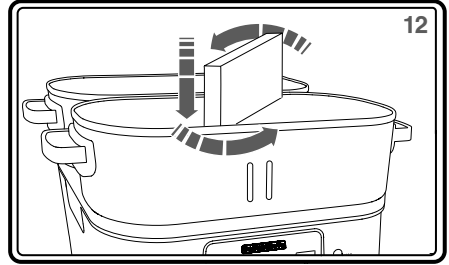
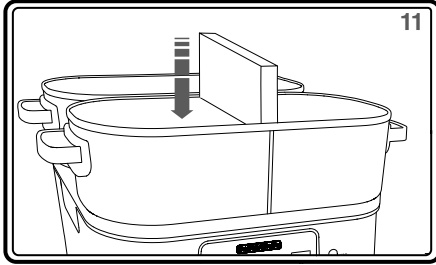
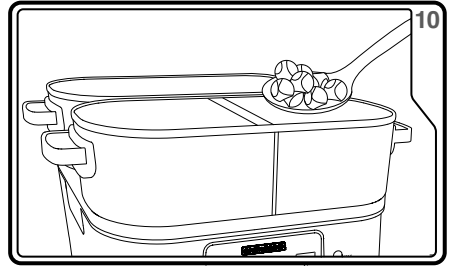
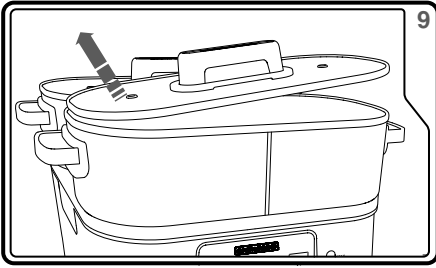

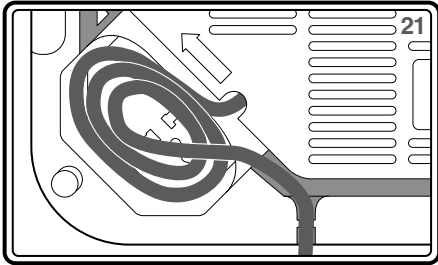
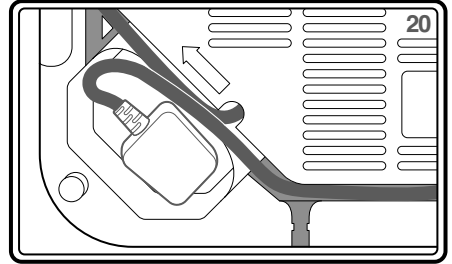
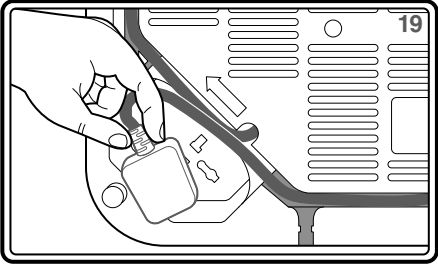
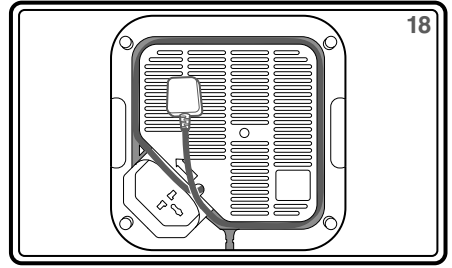
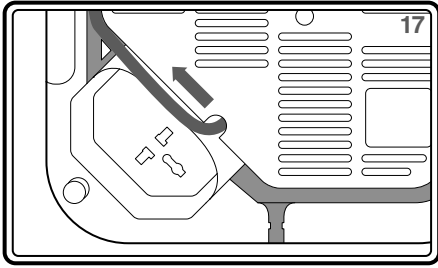



## Introduction

Thank you for your recent purchase of the Intellisteam. Please read this instruction booklet carefully to ensure you get the best performance from your new product.

## Contents

Health and Safety	2
Product Overview	4
Control Panel Features	5
Introduction	9
Overview	9
Before First Use	10
Using Your Intellisteam	10
Front Container Overview	10
Preset Cooking Times	10
Pausing During Cooking	10
Steaming Times	11
Keep Warm	11
Removing Food From Your Intellisteam	11
Fitting and Removing The Dividing Wall	11
Refilling The Water Tank During Use	11
Boil Dry Alarm and Auto Shut Off	11
The Intellisteam Button	11
Saving Time Adjustments	11
Hints and Tips	11
Descaling	12
Care and Cleaning	12
Using The Accessories	12
Cable Tidy	12
Adjusting The Cable Length	12
Steaming Guide	13
Recipes	18
Contact Us	29
Guarantee	30

## Features

- (1) Lid
- (2) Drip Tray
- (3) Water Inlet Filler
- (4) Steam Vent
- (5) Water Tank
- (6) Element
- (7) Water Gauge
- (8) Main Unit
- (9) Control Panel
- (10) Steam Tray
- (11) Rice Tray
- (12) Rear Container
- (13) Dividing Wall
- (14) Small Pots x2
- (15) Front Container
- (16) On/Off Button

## Control Panel Features

- (17) LCD Screen
- (18) Rear Heater Button
- (19) Front Left Heater Button
- (20) Front Right Heater Button
- (21) Front Dual Heater Button
- (22) Food Icons
- (23) Intellisteam Button
- (24) Timer (Front Left Compartment)
- (25) Timer (Rear Compartment)
- (26) Timer (Front Right Compartment)
- (27) Start/Pause Button
- (28) Increase Button
- (29) Decrease Button
- (30) Steaming Icon
- (31) Keep Warm Icon

## Overview

Congratulations on your purchase of the Morphy Richards Intellisteam. Intellisteam is the perfectly synchronised meal solution that will allow you to cook healthy, balanced meals all in one product. With its versatile accessories and 3 cooking chambers you can cook proteins, carbohydrates and vegetables in different combinations as well as much, much more including sauces and desserts. Cooking couldn't be easier with the intelligent control panel and 8 reprogrammable pre-sets, as Intellisteam manages the cooking process for you so all the elements are finished at the same time ready for you to enjoy.

## Before First Use

**WARNING: Never immerse the Main Unit (8), power cord or mains plug in water.**

It is important to wash all parts except the Main Unit (8) before first use. See 'Care and Cleaning' for cleaning instructions.

1. Wash the Water Tank (5) with hot soapy water and a dishcloth. Rinse and dry.
2. Wash the Lids (1), Drip Tray (2), Steam Tray (10), Rice Tray (11), Small Pots x2 (14), Containers (12), (15) and Dividing Wall (13) in hot soapy water. Rinse and dry.

Do not use abrasive cleaning products, e.g. scouring powders/pads, cream cleaners, steel wool or bleach on any part of the product as these will damage it.

Please note that when you first use your Intellisteam, you may notice some smoke/vapour emitting from the rear of the Main Unit (8), this is normal and is simply grease applied during the manufacturing process. After using your Intellisteam a few times this will stop. This is not dangerous and will not contaminate or flavour food cooked in your Intellisteam.

## Using Your Intellisteam

1. Fill the Water Tank (5) with cold water to the maximum level.
2. Fit the Drip Tray (2) to the Water Tank (5) and then place Containers (12),(15) on top.
3. Place the food in the Containers (12),(15). Use the Dividing Wall (13) when required. Refer to 'Fitting and Removing the Dividing Wall' to fit the Dividing Wall in the Front Container (15) to keep food separate. Cover each Container with the Lid (1).
4. Plug your Intellisteam into the mains and switch on using the On/Off Button (16) at the rear of the Main Unit (8). Your Intellisteam will beep and the LCD screen (17) will illuminate.
5. To set the steaming time, press the Heater Button (18), (19), (20), (21) relating to the compartment you would like to use. Press the button repeatedly to cycle through the default steaming times and select the required food group (22).

These are the default settings, see 'Steaming Guide' for a guide to steaming times.

6. Use the Increase (28) or Decrease (29) Buttons to adjust the cooking time (if required). Press while the relevant Timer Icon (24), (25), (26) is flashing. Repeat steps 5-6 for the other compartments (if required).
7. Press the Start/Pause Button (27). Your Intellisteam will beep, the Steaming Icon (30) and selected food icons will illuminate and the display times will start counting down.
8. When the timers reach zero the alarm will sound. Your Intellisteam will automatically switch to keep warm for 40 minutes (see 'Keep Warm' section). The timer will reset to 40 and the Keep Warm Icon (31) will illuminate.
9. When complete or when ready to serve, press the Start/Pause Button (27), and turn your Intellisteam off at the back of the unit or at the mains. Carefully lift the Lid (1) angling it away from you, to release steam safely.

**WARNING: Steam can burn.**

10. Carefully remove the cooked food from your Intellisteam.

**\*Note: If you have selected different times for each compartment the steaming icon will flash when each compartment begins the steaming process. Only follow steps 5-7 for compartments you intend to use. The timer display (24), (25), (26) will remain at '00' if not selected.**

## Front Container Overview

The Front Container (15) can be used in one of two ways; as two individual cooking compartments or one large single compartment. See 'Fitting and Removing the Dividing Wall' for fitting of Dividing Wall (13).

To use the Front Container (15) as a single steaming compartment, lift the Dividing Wall (13) out of the container and set aside. Follow steps 1-7 of 'Using your Intellisteam'. Use the Front Dual Heater Button (21) to select the steaming time.

The Dividing Wall (13) should be stored loose when not in use.

## Preset Cooking Times

Your Intellisteam features 8 preset cooking times. These are a guide and can be adjusted using the Increase (28) and Decrease (29) Buttons.

To cycle through the options, and select the desired preset cooking time for each compartment, press the relevant Rear (18), Left (19), Right (20), or Dual (21) Heater Button repeatedly.

Keep warm is preset at 40 minutes and cannot be increased.

## Preset cooking times as follows:

	Leaf/Pod vegetables	16 minutes
	Sauce	30 minutes
	Rice	40 minutes
	Keep Warm	40 minutes
	Eggs	16 minutes
	Root Vegetables	28 minutes
	Poultry	28 minutes
	Fish	20 minutes

## Pausing During Cooking

To pause your Intellisteam during the cooking process press the Start/Pause Button (27). The Steaming Icon (30) and Food Icons (22) will go out. To continue steaming, press the Start/Pause Button (27) again. The Steaming Icon (30) will illuminate.

Whilst your Intellisteam is paused, it is possible to amend the cooking times as detailed in steps 5-7 of 'Using your Intellisteam'. To cancel the steaming cycle, press and hold the Start/Pause Button (27).

## Steaming Times

Your Intellisteam has been designed so that all food is ready at the same time. When the steaming process begins, the timer will automatically start counting down from the longest cooking time so all the food in your Intellisteam completes cooking at the same time.

## Keep Warm

When cooking has finished, the alarm will sound and the keep warm function will start automatically for 40 minutes. To stop, press the Start/Pause Button (27) once. After 40 minutes the keep warm function will automatically turn off. Whilst Intellisteam is in keep warm mode, the Keep Warm Icon (31) will appear on the LCD screen (17).

Always check there is water in the Water Tank (5) when using the keep warm function. To check the water level, use the external Water Gauge (7) and fill using the external Water Inlet Filler (3).

## Removing Food From Your Intellisteam

**WARNING: Use oven gloves to remove the Lids (1) and Containers (12),(15), ensure the Lids are tilted to direct the steam away from you. Do not remove the Drip Tray (2) until it has completely cooled.**

When cooking noodles or pasta in the Rice Tray (11), take extra care when draining liquid after cooking.

## Fitting and Removing the Dividing Wall 11

### Plastic Containers:

Slide the Dividing Wall (13) into place.

### Stainless Steel Containers:

Insert the Dividing Wall (13) at an angle and twist into place. 12

The Dividing Wall (13) should be stored loose

## Refilling the Water Tank During Use 1E

If steaming for a long period, it may be necessary to add extra water. Use the Water Inlet Filler (3) to refill the Water Tank (5) during cooking.

Carefully pour cold water into the Water Inlet Filler (3) using a jug.

## Boil Dry Alarm and Shut Off

When the water level is lower than the "MIN" level on the Water Gauge (7), beeping will sound continuously.

If this happens mid steam cycle it will automatically shut off, stopping the cooking process.

If this occurs you should refill the Water Tank (5) with water as soon as possible. Use the Water Inlet Filler (3) to refill the Water Tank (5) as detailed above.

After a short period of time, the beeping will stop and the steaming cycle will resume. This should happen within approximately 15 seconds.

## The Intellisteam Button

You can use your Intellisteam to start the steaming of all compartments at the same time. This will enable you to take out cooked food as required whilst leaving food in other compartments to continue cooking.

1. Follow steps 1-6 of 'Using your Intellisteam' as required.
2. Press the Intellisteam Button (23). This will turn off the Intellisteam light. Press Start/Pause Button (27).
3. When the timer reaches zero on a particular compartment it will automatically switch to keep warm. Remove the food as required.
4. Other compartments will continue to steam until the timer shows zero.

## Saving Time Adjustments

To save your personal time adjustments for future use, hold down the Start/Pause Button (27) for three seconds. One double beep will sound, indicating steaming has begun, the second double beep indicates your time adjustments have been saved.

### Reverting Back to Preset Times

Press and hold both the Intellisteam Button (23) and the Start/Pause Button (27) together for two seconds until a beep is heard. Intellisteam is now returned to the original presets.

## Hints and Tips

- Cook meat, poultry, fish, shellfish and fruit in foil as this retains juices. To prevent skin on fish from sticking, lightly grease foil first.
- The Containers (12) (15) will become hot. Take care when removing the Lids (1) to avoid steam.
- Use tongs where practical to remove food wrapped in foil from the container.
- Handle the Small Pots (14) and Rice Tray (11) carefully when hot and full of liquid.
- The recipes provided serve two portions.
- The cooking guide provides information for up to 4 portions of most foods. Do be prepared to adjust the timings when you are familiar with your steamer to suit personal preference.
- Use the Front Container (15) with the Dividing Wall (13) for single portions and use the Rear Container (12) when cooking 2, 3 or 4 portions of food.
- Do not crowd food in the Containers (12) (15) or Rice Tray (11). Arrange food with spaces between pieces to allow for maximum steam flow.
- For best results use pieces of food that are similar in size. As a guide, cut potatoes/ sweet potatoes into rough chunks of 30mm, swede, celeriac and butternut squash into approximately 20mm chunks. Cut leeks, courgettes and carrots into roughly 10mm thick rounds, onion into 10mm slices.
- If pieces of food vary in size and layering is required, place smaller pieces on top.

## Descaling

Occasionally, you may need to remove mineral deposits (known as descaling) from the Water Tank (5). This is normal and will depend on the degree of hardness of the water in your area. If you notice a slowing in steam production, or a lengthening of steaming times, you should descale the steaming system using a mild descaling solution and follow instructions for food steamers.

Alternatively, fill the Water Tank to the maximum level with boiling water. Add two sachets of descaling solution and fit the Drip Tray. Set the steaming time to 40 minutes for each Element (6) and press the Start/Pause Button (27). Ventilate the room well. Repeat as necessary, then wash the Water Tank and Drip Tray with hot soapy water and a dishcloth, rinse and dry.

**WARNING: Do not attempt to move the Intellisteam until the Water Tank is completely cold.**

## Care and Cleaning

**WARNING: Never immerse the Main Unit (8), power cord or mains plug in water.**

1. Unplug from the wall socket and leave the appliance to cool completely before cleaning.
2. Do not clean any part of the unit with abrasive cleaners e.g. scouring powders, pads, steel wool or bleach.
3. Wipe out the Water Tank (5) and, if required, follow the descaling instructions.
4. Wash the Lid (1), Drip Tray (2), Steam Tray (10), Rice Tray (11), Containers (12) (15), Small Pots x2 (14) and Dividing Wall (13) in warm water and washing-up liquid. Rinse and dry.  
Alternatively, place in the dishwasher on cool or eco cycle.
5. The Dividing Wall (13) should be stored loose when not in use.

## Using the Accessories 14 15

Your Intellisteam is supplied with a Steam Tray (10), a Rice Tray (11) and Small Pots x2 (14).

Use the Steam Tray (10) when cooking fish fillets in foil. The Steam Tray can be placed directly into either the Front (15) or Rear (12) Container in its 'high' position. If necessary, fish fillets may be cooked in foil underneath the Steam Tray also.

The Rice Tray (11) is ideal for cooking rice, pasta, noodles and grains. A little water is added when cooking these foods. See the Steaming Guide for recommended quantities, hints and tips.

The Small Pots (14) may be used when cooking 1-2 eggs, for sauces and single portions of rice, noodles, pasta etc.

See 'Fitting and Removing the Dividing Wall' for fitting of Dividing Wall (13).

## Cable Tidy 17 18 19 20

In order to help with storage there is an inbuilt cable tidy.

1. Separate the Main Unit (8) from the other components and turn upside down.
2. Following the arrow, wrap the cable around clockwise ensuring the cable is in the cable
3. Once you have wrapped the cable back to the starting point, turn the plug back on itself and plug it into plug socket provided.

## Adjusting the Cable Length 21

If you would like to reduce the operating cable length it is possible to do so by using the plug socket recess under the Main Unit.

1. Where the cable exits the product, coil it in the plug socket recess until your cable is at your desired length. You may find it easier coiling anti clockwise.
2. Secure the cable by pushing into the cable recess and cable exit at the back of the product.

## Steaming Guide

Steaming times and portion sizes stated below are a guide only. Times may vary depending on the size of the food, the spacing of the food in the Containers (12), (15) the freshness of food and personal preference. As you become familiar with the steamer, adjust cooking times as required. Steaming times are for the quantities stated in the guide, for larger or smaller quantities adjust the time accordingly.

### Leaf and Pod Vegetables (preset time: 16 mins)

Food Type	1 Portion	2 Portions	3 Portions	4 Portions	Hints and Tips
Asparagus	10 mins 60g/2oz	10 mins 120g/5oz	11 mins 180g/6oz	12 mins 240g/8oz	
Beans – Broad beans	15 mins 50g/2oz	15 mins 100g/4oz	15 mins 150g/6oz	15 mins 200g/7oz	
Beans – Fine green beans	15 mins 50g/2oz	15 mins 100g/4oz	15 mins 150g/6oz	15 mins 200g/7oz	
Beans – Runner beans	15 mins 60g/2oz	15 mins 120g/5oz	15 mins 180g/6oz	16 mins 240g/8oz	
Broccoli florets	12 mins 60g/2oz	14-15 mins 120g/5oz	16-17 mins 180g/6oz	18 mins 240g/8oz	
Broccoli – “Tender stem”	12 mins 50g/2oz	12 mins 100g/4oz	13 mins 150g/6oz	13 mins 200g/7oz	
Cabbage	12 mins 50g/2oz	12 mins 100g/4oz	13 mins 150g/6oz	13 mins 200g/7oz	Roughly chop before cooking
Cauliflower florets	15 mins 100g/4oz	15 mins 200g/7oz	15 mins 300g/10oz	15 mins 400g/14oz	
Courgette	13 mins 60g/2oz	13 mins 120g/5oz	13 mins 180g/6oz	13 mins 240g/8oz	Approximately 10mm rounds
Kale	12 mins 50g/2oz	12 mins 100g/4oz	15-16 mins 150g/6oz	18 mins 200g/7oz	Roughly chop before cooking
Leeks	15 mins 70g/3oz	15 mins 140g/6oz	17 mins 210g/7oz	19 mins 280g/9oz	Approximately 10mm rounds
Mangetout	8 mins 50g/2oz	8 mins 100g/4oz	9 mins 150g/6oz	9 mins 200g/7oz	
Pak choi	10 mins 80g/3oz	11 mins 160g/6oz	11 mins 240g/8oz	12 mins 320g/10oz	Roughly cut leaves, stalks to be sliced approximately 10mm thick
Peas (fresh)	10 mins 60g/2oz	10 mins 120g/5oz	10 mins 180g/6oz	12 mins 240g/8oz	
Peas (frozen)	10 mins 60g/2oz	10 mins 120g/5oz	11 mins 180g/6oz	11 mins 240g/8oz	
Peppers	12 mins 80g/3oz	12 mins 160g/6oz	12 mins 240g/8oz	12 mins 320g/10oz	Chunks roughly 30 x 30 mm
Spinach – Baby leaves	10 mins 60g/2oz	10 mins 120g/5oz	10 mins 180g/6oz	10 mins 240g/8oz	

AUS

Food Type	1 Portion	2 Portions	3 Portions	4 Portions	Hints and Tips
Sprouts	15 mins 100g/4oz	21 mins 200g/7oz	22 mins 300g/10oz	22 mins 400g/14oz	
Sugarsnaps	13 mins 75g/3oz	14 mins 150g/6oz	15 mins 225g/8oz	16 mins 300g/10oz	
Sweetcorn (canned)	7mins 80g/3oz	8 mins 160g/6oz	8 mins 240g/8oz	9 mins 320g/10oz	
Sweetcorn (frozen kernels)	12-14 mins 80g/3oz	14 mins 160g/6oz	15 mins 240g/8oz	16 mins 320g/10oz	

### Rice/Grains/Pasta/Noodles (preset time: 40 mins)

Food Type	1 Portion	2 Portions	3 Portions	4 Portions	Hints and Tips
Easy cook white rice	30 mins 75g/3oz	31 mins 150g/6oz	32 mins 225g/8oz	40 mins 300g/10oz	Add 100ml cold water per 75g portion of rice and stir
Easy cook brown rice	40-42 mins 75g/3oz	44 mins 150g/6oz	46 mins 225g/8oz	48 mins 300g/10oz	Add 100ml cold water per 75g portion of rice and stir
White basmati rice	25 mins 75g/3oz	25-26 mins 150g/6oz	27 mins 225g/8oz	28 mins 300g/10oz	Add 100ml cold water per 75g portion of rice and stir
Brown basmati rice	45 mins 75g/3oz	47 mins 150g/6oz	49 mins 225g/8oz	51 mins 300g/10oz	Add 100ml cold water per 75g portion of rice and stir
White long grain rice	30-31 mins 75g/3oz	31-32 mins 150g/6oz	31-32 mins 225g/8oz	31-32 mins 300g/10oz	Add 100ml cold water per 75g portion of rice and stir
Bulgur wheat	16 mins 30g/1oz	18 mins 60g/2oz	19 mins 90g/3oz	20 mins 120g/4oz	Add 30ml cold water per 30g portion. Drain if required after cooking fork up and leave to stand 10 mins
Couscous	15 mins 35g/1oz	19 mins 70g/2oz	20 mins 105g/4oz	21 mins 140g/5oz	Add 30ml cold water per 35g portion
Quinoa	25 mins 30g/1oz	27 mins 60g/2oz	28 mins 90g/3oz	29 mins 120g/4oz	Add 75ml boiling water per 30g
Pasta	30 mins 75g/3oz	32 mins 150g/6oz	To large to fit in the rice tray	To large to fit in the rice tray	Ensure water covers pasta
Whole wheat pasta	30 mins 75g/3oz	31 mins 150g/6oz	To large to fit in the rice tray	To large to fit in the rice tray	Ensure water covers pasta
Egg noodles	20 mins 1 sheet 60g/2oz	20 mins 2 sheets 120g/5oz	22 mins 3 sheets 180g/7oz	To large to fit in the rice tray	Ensure boiling water covers noodles. For 1 portion in a Small Pot, break up noodles first to fit.
Ready to wok noodles	16 mins 1 pack 150g/6oz	16 mins 2 packs 300g/10oz	17 mins 3 packs 450g/17oz	To large to fit in the rice tray	Gently separate, add 1 tbsp cold water per portion and stir

Rice noodles	15 mins 1 pack 150g/6oz	15 mins 2 packs 300g/10oz	17 mins 3 packs 450g/17oz	To large to fit in the rice tray	Gently separate, add 1 tbsp cold water per portion and stir
Whole wheat noodles	22 mins 1 nest 50g/2oz	22 mins 2 nests 100g/4oz	22 mins 3 nests 150g/6oz	To large to fit in the rice tray	Ensure boiling water covers noodles.

#### Hints and Tips

- Rinse rice and grains such as couscous, quinoa and bulgur wheat under cold running water prior to cooking.
- Using boiling water for noodles, pasta, rice and other grains reduces the recommended cooking times by about two minutes.
- Gently separate ready to wok and rice noodles before cooking in the Rice Tray as they will cook more quickly than when used straight from the packet. Similarly before cooking a single portion of ready to wok or egg noodles in the Small Pot (14), it will be necessary to lightly break them up so that they fit.
- Use a good quality brand when cooking pasta.

### Eggs (preset time: 16 mins)

Food Type	1 Portion	2 Portions	3 Portions	4 Portions	Hints and Tips
Soft boiled	12 mins x1	12 mins x2	12 mins x3	12 mins x4	Use Rice Tray (11). 2 eggs may also be cooked in Small Pot (14) for 14 minutes in Front Container (15).
Hard boiled	12 mins x1	12 mins x2	12 mins x3	12 mins x4	Use Rice Tray (11). 2 eggs may also be cooked in Small Pot (14) for 22 minutes in Front Container (15).

### Fruit

Food Type	1 Portion	2 Portions	3 Portions	4 Portions	Hints and Tips
Dessert apples	15 mins x1	15 mins x2	20-21 mins x3	21-22 mins x4	Peel, core and cut into approximately 10mm thick slices and cook in foil. Add a little lemon juice to prevent browning.
Pears					
Dessert apples	21 mins x1	22 mins x2	22 mins x3	22 mins x4	Peel, halve and core before cooking in foil. Add a little lemon juice to prevent browning.

## Root Vegetables (preset time: 28 mins)

Food Type	1 Portion	2 Portions	3 Portions	4 Portions	Hints and Tips
Butternut squash	10-12 mins 100g/4oz	14 mins 200g/7oz	16 mins 300g/10oz	18 mins 400g/14oz	Cut into approximately 20mm chunks
Carrots	25 mins 100g/4oz	26 mins 200g/7oz	26-27 mins 300g/10oz	28-30 mins 400g/14oz	Cut into 10mm rounds
Celeriac	30 mins 100g/4oz	30 mins 200g/7oz	30 mins 300g/10oz	32 mins 400g/14oz	Cut into approximately 20mm chunks
New potatoes	21 mins 180g/6oz	24-25 mins 350g/12oz	25-26 mins 530g/19oz	26-28 mins 760g/27oz	
Old potatoes	23-25 mins 180g/6oz	24-25 mins 350g/12oz	24-26 mins 530g/19oz	28-30 mins 760g/27oz	Cut into approximately 30mm chunks
Onions	18 mins 50g/2oz	18 mins 100g/4oz	20 mins 150g/6oz	22 mins 200g/7oz	Sliced, approx. 10mm thick
Parsnips	24 mins 100g/4oz	24 mins 200g/7oz	24 mins 300g/10oz	24 mins 400g/14oz	Cut into chunks approx. 60mm x 30mm
Swede	20-21 mins 100g/4oz	22 mins 200g/7oz	24 mins 300g/10oz	25 mins 400g/14oz	Cut into approximately 20mm chunks
Sweetcorn (whole cobs)	30-32 mins for 1 whole cob 250g/9oz		30-32 mins for 2 whole cobs 500g/18oz		
Sweet potatoes	21 mins 180g/6oz	21 mins 350g/12oz	23-24 mins 530g/19oz	25-26 mins 760g/27oz	Cut into approximately 30mm chunks

## Meat/Poultry (preset time: 28 mins)

White protein residue on meat and poultry may be apparent after cooking. This is normal.

Food Type	1 Portion	2 Portions	3 Portions	4 Portions	Hints and Tips
Chicken breast whole, skinless and boneless	20 mins x1 150g/6oz	23 mins x2 300g/11oz	29 mins x3 450g/16oz	32 mins x4 600g/21oz	Wrap in single layer of foil to retain juices
Duck breast whole, skinless and boneless	20 mins x1 120g/5oz	23 mins x2 240g/8oz	29 mins x3 360g/12oz	32 mins x4 480g/16oz	Wrap in single layer of foil to retain juices
Chicken drumsticks	40 mins x1 200g/7oz	48 mins x2 400g/14oz	50 mins x3 600g/21oz	50 mins x4 80g/28oz	Wrap in single layer of foil to retain juices
Turkey breast steak	12 mins x1 100g/4oz	13 mins x2 200g/7oz	15 mins x3 300g/10oz	20 mins x4 400g/14oz	Wrap in foil to retain juices

### Hints and Tips

- Marinating meat and poultry before cooking, improves flavour. For best results marinate for a minimum of 30 minutes or several hours or overnight if time permits.
- Never steam meat or poultry or seafood from frozen. Allow to thaw completely first.



## Fish/Shellfish (preset time: 20 mins)

Food Type	1 Portion	2 Portions	3 Portions	4 Portions	Hints and Tips
Thick fillet of fish	17 mins 130g/5oz	20 mins 260g/9oz	22 mins 390g/13oz	25 mins 520g/18oz	Wrap in single layer of foil to retain juices
Thin fillet of fish	14 mins 100g/4oz	15-16 mins 200g/7oz	17 mins 300g/10oz	21 minutes 400g/14oz	Wrap in single layer of foil in Steam Tray (10). For 3 and 4 fillets, place fish in foil on top of and below tray
Whole fish, cleaned	21 mins for 1 whole fish 250g/9oz				Wrap in foil to retain juices. Use Steam Tray (10)
Mussels	11 mins 250g/9oz	12 mins 500g/18oz	15 mins 750g/27oz	17 mins 1kg/36oz	
King prawns (raw)	7 mins 100g/4oz	9 mins 200g/7oz	12 mins 300g/10oz	15-16 mins 400g/14oz	Wrap in foil to retain juices.
Scallops	6 mins x3 70g/3oz	7 mins x6 150g/5oz	7 mins x9 230g/8oz	9 mins x12 300g/10oz	Wrap in foil to retain juices.

### Hints and Tips

- It is possible to cook two thin fish fillets on the Steam Tray (10) and one or two under it if required. Be aware that the fish in the lower position will cook slightly more quickly. Wrap the fish in foil for best results.
- Never steam fish or seafood from frozen. Allow to thaw completely first.

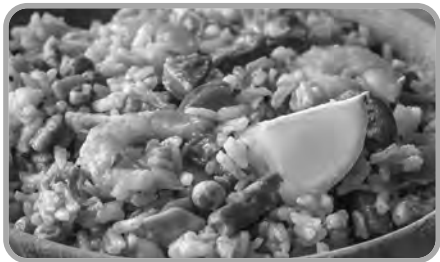
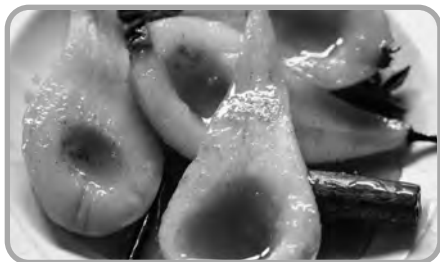

*The recipes in this book have been developed and tested by Morphy Richards specifically for your Intellisteam. They include healthy meals for two people complete with sides such as vegetables and rice. In addition there are a selection of desserts when you fancy a treat. The cooking times for the recipes are a guide and will be affected by the size and freshness of the ingredients used.*

*Always ensure food is thoroughly cooked before serving.*

*Recipes serve 2 people. If you reduce the portion sizes, please adjust the cooking times as appropriate.*

## Fish/Shellfish Recipes

### Steamed Cod with Lemon and Thyme Dressing and Vegetables

Preparation time: 10 minutes

Cooking time: 25 minutes

Serves: 2

#### Ingredients:

- 2 x 140g thick cod fillets
- 4g butter
- 2 small fresh thyme sprigs
- A little salt and freshly ground black pepper

#### Sauce:

- 25g butter
- Finely grated zest and juice of half a lemon
- ½ tbsp fresh thyme leaves

#### Vegetables:

- 350g small new potatoes
- 100g leek thinly sliced
- 50g carrot sliced into fine strips
- 75g fine green beans, trimmed and halved

#### Method:

- 1 Lightly grease a piece of foil big enough to make a parcel, then place the fish on it side by side. Add a 2g knob of butter to each, add the thyme sprigs and season with salt and pepper, then seal the foil parcel and place in the Rear Container, leaving room on one side for the Small Pot.
- 2 Next make the sauce: put 25g butter, lemon zest and juice and the thyme leaves into the Small Pot and place next to the fish.
- 3 Position the Dividing Wall in the Front Container. Put the potatoes into one compartment. Mix the leek, carrot and beans together and put in the other compartment. Cover both Containers with the Lids.
- 4 Set the time for the fish and sauce using the fish preset (20 mins). Adjust to 19 minutes. Set the time for the potatoes using the root vegetables preset (28 mins), adjust to 25 minutes. Set the time for the vegetables using the leaf and pod vegetables preset (16 minutes) and adjust to 15 minutes. Press the Start/Pause Button.

### Sesame Salmon Noodles and Steamed Greens with Coconut Milk and Sweet Chilli Sauce

Preparation time: 15 minutes

Cooking time: 30 minutes

Serves: 2

#### Ingredients:

- 2 x 130g salmon fillets
- 1½ tsp sesame oil
- 1 tsp sesame seeds

#### Noodles:

- 1 x 150g sachet medium ready to wok noodles
- 2 tbsp boiling water
- ¼ tsp vegetable stock powder

#### Vegetables:

- 75g sugar snap peas, halved
- 35g spring onions, thinly sliced
- 60g carrot, cut into strips

#### Sauce:

- 150ml light coconut milk
- 1 tbsp sweet chilli sauce
- ½ tsp fresh ginger, finely grated
- 1 tsp coriander leaves, chopped

#### Method:

- 1 Brush a piece of foil with ½ tsp oil then put salmon onto it, brush with the remaining oil and sprinkle with the sesame seeds. Form a parcel and place in the Rear Container leaving room for a Small Pot.
- 2 Gently break up the noodles and place in the Small Pot. Mix the water and stock powder together and add to the noodles. Place in the Rear Container next to the fish.
- 3 Position the Dividing Wall in the Front Container. Mix the vegetables together and put into one compartment.
- 4 Make the sauce: pour coconut milk into a Small Pot and stir in the sweet chilli sauce, ginger and coriander. Place the Pot in the other compartment. Cover both Containers with the Lids.
- 5 Set the time for the fish and noodles using the fish preset (20 minutes), adjust to 19 minutes, set the time for the vegetables using the leaf and pod preset (16 minutes), adjust to 14 minutes. Set the time for the sauce using the sauce preset (30 minutes) and then press the Start/Pause Button.
- 6 When ready, stir the noodles before serving.

## Kedgeree

Preparation time: 10 minutes

Cooking time: 31 minutes

Serves: 2

### Ingredients:

- 2 x 140g thick smoked haddock fillets
- 2 medium eggs

### Rice:

- 150g easy cook long grain rice
- 50g onion, very finely chopped,
- ¾ level tsp hot curry powder,
- Good pinch salt
- 200ml water

### To Serve:

- 2 tbsp chopped fresh parsley, lemon wedges

### Method:

- 1 Remove the Dividing Wall from the Front Container and put the eggs in a Small Pot in one side. In the other side put the fish in a foil parcel.
- 2 Rinse the rice under cold running water and then drain and place in the Rice Tray with the onion, curry powder, salt and water. Stir the mixture and then place into the Rear Container. Cover both Containers with the Lids.
- 3 Set the time for the rice using the rice preset (40 minutes) adjust to 31 minutes. Use the Front Dual Heater Button to set the time for the fish and eggs using the fish preset (20 minutes). Press the Start/Pause Button.
- 4 When ready, immediately plunge the eggs into a bowl of cold water. Leave for a minute then peel and roughly chop. Leave the rice to keep warm, while you remove the fish skin and flake the fish.
- 5 Add the eggs and fish to the rice and gently stir, add the chopped parsley and then serve immediately with a squeeze of lemon, salad and crusty bread.

## Prawn and Pea Risotto

Preparation time: 10 minutes

Cooking time: 40 minutes

Serves: 2

### Ingredients:

- 165g raw king prawns
- 100g frozen peas

### Rice:

- 150g Arborio risotto rice
- 100g onion, very finely chopped
- 6 tbsp dry white wine
- 2 level tsp vegetable stock powder
- Zest and juice ½ lemon
- A little salt and freshly ground black pepper
- 25g unsalted butter
- 250ml boiling water

### Garnish:

- Chopped fresh parsley

### Method:

- 1 Fit the Dividing Wall in the Front Container. Make a foil parcel for the prawns and put into one compartment. Put the peas into the Small Pot and put in the other side.
- 2 Put the rice and onion in the Rice Tray, add the wine and stir.
- 3 Sprinkle on the stock powder, lemon juice and zest, season with a little pepper and stir again then dot the butter evenly on the surface.
- 4 Add the water to the rice mixture and stir well. Place the Rice Tray into the Rear Container and cover both Containers with the Lids.
- 5 Set the time for the rice using the rice preset (40 minutes). Set the time for the prawns using the fish preset (20 minutes) and adjust to 9 minutes. Set the time for the peas using the leaf and pod preset (16 minutes) and adjust to 19 minutes. Press the Start/Pause Button.
- 6 When ready, first remove the prawns from the container to stop them cooking any more. Stir the rice, add the prawns with 2 tbsp of the prawn juices. Drain the peas of any liquid, then stir them into the rice. Adjust the seasoning if necessary and then serve the risotto with a sprinkling of chopped parsley.

## Sea Bass Fillets with Fresh Tomato and Herb Sauce, Peas with Garlic and New Potatoes

Preparation time: 15 minutes

Cooking time: 30 minutes

Serves: 2

### Ingredients:

- 2 x 100g sea bass fillets

### Sauce:

- 180g ripe fresh tomatoes
- ½ clove garlic, crushed
- 1 tbsp fresh parsley, chopped
- ½ tsp olive oil
- Salt and freshly ground black pepper

### Vegetables:

- 120g frozen peas
- 30g onion, very finely chopped
- 1 clove garlic, crushed
- ½ level tsp vegetable stock powder
- 50ml water
- 350g new potatoes

### To Serve:

- Fresh lemon

### Method:

- 1 Prepare the sauce first: put the tomatoes into a bowl and pour boiling water over them. When the skin splits, remove it and discard. Cut open the tomatoes and discard the seeds and core.
- 2 Finely chop the tomato flesh and mix with ½ a crushed garlic clove, the parsley, olive oil and a little salt and pepper.
- 3 Lightly grease a piece of foil and lay the two fish fillets on it side by side. Spoon the tomato mixture over them and make into a parcel. Place in the Rear Container on the Steam Tray in its high position.
- 4 Put the Dividing Wall into the Front Container. Put the peas, onion and crushed garlic into a Small Pot with the vegetable stock powder and water. Put into one side. In the other, put the new potatoes. Cover both Containers with the Lids.
- 5 Set time for fish using fish preset (20 minutes). Set time for peas using the leaf and pod preset (16 minutes) and adjust to 30 minutes. Set the time for the potatoes using the root vegetables preset (28 minutes) and adjust to 25 minutes. Press the Start/Pause Button.
- 6 When ready drain the liquid from the peas and serve the fish with a little fresh lemon.

## Mac's Fresh Mussels with a Garlic and White Wine Broth

Preparation time: 20 minutes

Cooking time: 24 minutes

Serves: 2 as a starter

### Ingredients:

- 500g fresh mussels, cleaned with beard removed

### Broth:

- 1 shallot, very finely chopped
- 2 cloves garlic, crushed
- 30g unsalted butter
- Zest of 1 lemon
- 3 tbsp lemon juice
- 250ml dry white wine
- 1 tbsp chopped parsley
- A little salt and freshly ground black pepper

### To Serve:

- Chopped parsley, lemon wedges, good bread

### Method:

- 1 Prepare the broth first: divide the ingredients equally between the two Small Pots, stir gently and then put them into the Front Container with the Dividing Wall removed.
- 2 Make sure the cleaned mussels are all fully closed (tap gently on a chopping board). Discard any that remain open or any with damaged shells.
- 3 Put the mussels into the Rear Container. Cover both Containers with the Lids.
- 4 Set the time for the mussels using the fish preset (20 minutes) and adjust to 12 minutes. Set the time for the sauce using the sauce preset (30 minutes) and the Front Dual Heater Button and adjust to 24 minutes. Press the Start/Pause Button.
- 5 When ready, discard any mussels that have not opened. Serve the mussels with the broth poured over them, sprinkled with a little extra chopped parsley, lemon wedges and some fresh bread for dipping.

---

## Meat Recipes

---

### Moroccan Lamb with Fruit and Nut Couscous and Orange and Coriander Salsa

---

Preparation time: 30 minutes, plus marinating time

Cooking time: 30 minutes

Serves: 2

#### Ingredients:

- 300g lamb leg steaks, cut into thin slices

#### Marinade:

- 2 tbsp extra virgin olive oil
- 1 tbsp fresh orange juice
- 1 level tsp cumin
- ¼ level tsp turmeric
- 2 level tsp harissa paste
- 5g fresh coriander, chopped
- Salt and freshly ground black pepper

#### Couscous:

- 140g couscous, rinsed and drained
- 50g red onion, finely chopped
- 75g ready to eat soft dried apricots, chopped
- 35g almonds, roughly chopped
- ½ level tsp vegetable stock powder
- A little salt and freshly ground black pepper
- 120ml water

#### Salsa:

- 2 medium oranges, peeled, and finely chopped
- Juice of half an orange
- 10g red onion, finely chopped
- 2g coriander leaves, chopped

#### Garnish:

- Watercress

#### Method:

- 1 Prepare the marinade for the meat first: mix the olive oil, orange juice, spices and coriander in a shallow dish and season with a little salt and pepper.
- 2 Place the sliced lamb in the dish and turn so that it is evenly coated. Cover and refrigerate for at least 30 minutes, longer if possible.
- 3 When ready to cook, discard any liquid marinade and put the meat into a foil parcel. Remove the Dividing Wall from the Front Container and put the parcel in.
- 4 Put the couscous in the Rice Tray and add the onion, apricots, almonds and stock powder. Season with a little salt and pepper and add the water and stir. Put into the Rear Container and cover both Containers with the Lids.
- 5 Set the time for the couscous using the rice preset (40 minutes) and adjust to 24 minutes. Set the time for the meat using the poultry preset (28 minutes) and adjust to 30 minutes. Press the

Start/Pause Button.

- 6 Meanwhile make the salsa: put all the ingredients into a small serving bowl and mix well.
- 7 When ready to serve, fluff the couscous up with a fork, check the seasoning and serve the meat with the juices poured over. Garnish with a few sprigs of watercress and serve the salsa.

### Whole Wheat Penne with a Chilli Chorizo Sauce

---

Preparation time: 15 minutes

Cooking time: 45 minutes

Serves: 2

#### Ingredients:

- 150g whole wheat penne

#### Sauce:

- 50g onion, very finely chopped
- 1 garlic clove, crushed
- 7g green chilli, very finely chopped with seeds
- 75g chorizo, chopped
- 3 tbsp parsley, chopped
- 500g tomato passata
- Freshly ground black pepper

#### To Serve:

- Parmesan cheese, garlic bread

#### Method:

- 1 Prepare the sauce first: In a bowl, mix the onion, garlic, chilli, chorizo and parsley with the passata and add a little freshly ground black pepper.
- 2 Remove the Dividing Wall from the Front Container. Divide the tomato sauce equally between the two Small Pots and place in the Front Container.
- 3 Put the penne into the Rice Tray, cover with boiling water, stir and then carefully place in the Rear Container. Cover both Containers with the Lids.
- 4 Set time for penne using rice preset (40 minutes) and adjust to 29 minutes. Set time for sauce using the Front Dual Heater Button and sauce preset (30 minutes), adjust to 45 minutes. Press the Start/Pause Button.
- 5 When ready, carefully drain the penne, then return to the Rice Tray. Pour over the sauce, adjust the seasoning if necessary and serve sprinkled with a little Parmesan cheese.

## Poultry/Chicken Recipes

### Tandoori Chicken with Zesty Cardamom Rice

Preparation time: 10 minutes plus marinating

Cooking time: 28 minutes

Serves: 2

#### Ingredients:

- 2 tbsp low fat natural yogurt
- 2 tbsp tandoori spice marinade
- 1½ tbsp fresh coriander leaves, chopped
- 2 x 150g skinless, boneless chicken breasts, cut into bite-sized chunks
- A little salt and freshly ground black pepper

#### Rice:

- 150g basmati rice
- 200ml water
- 1 level tsp vegetable stock powder
- 1 strip pared lemon zest
- 4 green cardamom pods, lightly crushed

#### To Serve:

- Lemon wedges, chopped fresh coriander and lemon yogurt dressing

#### Method:

- 1 Mix the yogurt, spice marinade and coriander in a non-metallic bowl and stir in the chicken. Season with a little salt and pepper, cover and refrigerate for at least 30 minutes.
- 2 Rinse the rice under cold running water and then place into the Rice Tray. Add the water. Stir in the vegetable stock powder and add the lemon zest and cardamom pods. Place the Rice Tray into the Rear Container.
- 3 Place the chicken and marinade onto some tin foil, spread out well and make a parcel. Remove the Dividing Wall from the Front Container and put the parcel in. Cover both Containers with the Lids.
- 4 Set time for rice using rice preset (40 mins) and then adjust to 25 minutes. Set time for the chicken using the poultry preset (28 minutes) using the Front Dual Heater Button and press the Start/Pause Button.
- 5 When ready, discard the lemon zest, then serve garnished with lemon wedges and fresh coriander. To serve, 2 tbsp natural yogurt mixed with a little lemon juice to taste makes a simple dressing.

### Hoisin Duck with Egg Noodles and Steamed Chinese-Spiced Vegetables

Preparation time: 10 minutes plus marinating

Cooking time: 28 minutes

Serves: 2

#### Ingredients:

- 2 x 150g skinless duck breasts, thinly sliced
- 2 tbsp hoisin sauce

#### Vegetables:

- 150g head pak choi
- 180g pack fresh stir fry vegetables
- 1 tbsp sesame oil
- ¼ level tsp Chinese 5 spice powder

#### Noodles:

- 2 sheets medium egg noodles
- Boiling water to cover

#### Garnish:

- 2 spring onions, thinly sliced
- ½ tsp sesame seeds

#### Method:

- 1 Coat the sliced duck breasts in the hoisin sauce. Cover and refrigerate for at least 30 minutes.
- 2 Make a foil parcel for the duck and marinade. Position the Dividing Wall in the Front Container and place the duck in one of the front compartments.
- 3 Separate and rinse the pak choi, then slice the stalks and roughly cut the leaves.
- 3 In a bowl, toss the pak choi and stir fry vegetables with the sesame oil and 5 spice powder and then place into the other front compartment.
- 4 Put the noodles into the Rice Tray in the Rear Container and cover them with boiling water. Cover both Containers with the Lids.
- 5 Set the time for the noodles using the rice preset (40 minutes) and adjust to 20 minutes. Set time for the duck using the poultry preset (28 minutes). Set time for the stir fry vegetables using the leaf and pod preset (16 minutes), and adjust to 12 minutes. Press the Start/Pause Button.
- 6 When ready stir the noodles and carefully drain before serving.
- 7 Serve the duck with the hoisin juices, sprinkle on sesame seeds and garnish with spring onions.

AUS

## Maple-Glazed Chicken with Corn on the Cob and Crushed Butternut Squash

Preparation time: 15 minutes plus marinating

Cooking time: 30 minutes

Serves: 2

### Ingredients:

- 2 x 150g skinless boneless chicken breasts
- Finely grated zest and juice of ½ an orange
- 1 tbsp maple syrup
- 1 tsp dried chilli flakes
- Salt and freshly ground black pepper

### Vegetables:

- 1 corn on the cob, halved
- 300g butternut squash, peeled deseeded and cut into chunks

### Rice:

- 100g white and wild rice
- 150ml water
- ½ level tsp vegetable stock powder

### To Serve:

- 7g butter
- ½ tsp fresh rosemary, finely chopped

### Method:

- 1 Put the orange zest, juice, maple syrup and chilli flakes into a non-metallic bowl. Add a little salt and pepper and stir well, then add the chicken, coating with the glaze. Turn the chicken over to coat and then cover and refrigerate for at least 30 minutes, turning from time to time.
- 2 Put the chicken into a foil parcel, discard the glaze and place in the Rear Container. Put the butternut squash cubes next to the chicken.
- 3 Position the Dividing Wall in the Front Container. Rinse the rice under cold running water and place in the Small Pot. Cover with the water, add the vegetable stock powder and stir. Place the Small Pot in one front compartment. Put the corn on the cob into the other compartment. Cover both Containers with the Lids.
- 4 Set the time for the chicken and butternut using the poultry preset (28 minutes) and adjust to 24 minutes. Set the time for the corn on the cob using root vegetables preset (28 minutes) and adjust to 16 minutes. Set time for rice using the rice preset (40 minutes) and adjust to 30 minutes. Press the Start/Pause Button.
- 5 When ready, add the butter and rosemary to butternut squash in a bowl and crush lightly with a fork.

## Chicken in a Creamy Pesto Sauce with Baby Vegetables

Preparation time: 10 minutes

Cooking time: 24 minutes

Serves: 2

### Ingredients:

- 2x 150g skinless and boneless chicken breasts

### Vegetables:

- 350g miniature potatoes
- 180g pack sugar snap peas, trimmed fine beans and tender stem broccoli

### Sauce:

- 2 tbsp dry white wine
- 100ml whipping cream
- 1½ tbsp pesto
- A little salt and freshly ground black pepper

### Method:

- 1 Put the chicken breasts side by side on foil and make a parcel. Place in the Rear Container leaving room for a Small Pot.
- 2 Put the Dividing Wall into the Front Container and put the potatoes in one side, the green vegetables in the other.
- 3 Mix the wine, cream and pesto in the Small Pot and season with a little salt and pepper. Put the Small Pot in the Rear Container next to the chicken. Cover both Containers with the Lids.
- 4 Set the time for the chicken and sauce using the poultry preset (28 minutes) and adjust to 23 minutes. Set the time for the potatoes using the root vegetable preset (28 minutes) and adjust to 24 minutes. Set the time for the green vegetables using the leaf and pod preset (16 minutes) and adjust to 12 minutes. Press the Start/Pause Button.
- 5 When ready, stir the sauce, check the seasoning then serve spooned over the chicken.



## Warm Chicken and Quinoa Salad with Walnuts

Preparation time: 30 minutes, plus marinating time

Cooking time: 29 minutes

Serves: 2

### Ingredients:

- 300g skinless, boneless chicken thigh fillets

### Marinade:

- Juice and zest of 1 lemon
- 2 tbsp extra virgin olive oil
- 1 clove garlic, crushed
- 2 level tsp fresh mint, chopped
- 1 level tbsp fresh parsley, chopped
- Salt and freshly ground black pepper

### Quinoa:

- 120g quinoa, rinsed and drained
- 300ml boiling water

### Salad:

- 2 tbsp extra virgin olive oil
- Juice of 1 lemon
- 3 level tbsp mint, chopped
- 1 level tbsp parsley, chopped
- 50g spring onions, chopped
- 50g walnuts, roughly chopped
- 100g cucumber, peeled, deseeded and diced (prepared weight)

### To Serve:

- Lemon yogurt dressing, flatbread

### Method:

- 1 First, mix the marinade ingredients together in a bowl.
- 2 Chop the chicken into bitesize pieces and add to the bowl and mix well. Cover and refrigerate for at least 30 minutes, longer if possible.
- 3 When ready to cook, remove the Dividing Wall from the Front Container. Make a foil parcel for the chicken and place in the Front Container.
- 4 Put the quinoa into the Rice Tray and cover with the boiling water. Put into the Rear Container and cover both Containers with the Lids.
- 5 Set the time for the quinoa using the rice preset (40 minutes) and adjust to 29 minutes. Set the time for the chicken using the poultry preset (28 minutes) and adjust to 25 minutes. Press the Start/Pause Button.
- 6 When ready allow the quinoa to stand for 10 minutes before draining off any water and forking up.
- 7 To assemble the salad: put the quinoa in a large mixing bowl, add 2 tbsp oil and the juice of a lemon. Stir in the chopped herbs. Add the drained chicken, spring onions, walnuts and cucumber and serve immediately garnished with a few walnut halves and lemon wedges.
- 8 2 tbsp natural yogurt mixed with a little lemon juice makes a simple dressing.

## Honeyed Sriracha Chicken Wraps

Preparation time: 15 minutes, plus marinating time

Cooking time: 25 minutes

Serves: 2

### Ingredients:

- 300g skinless, boneless chicken thigh fillets, cut into bitesize pieces.

### Marinade:

- 1 small clove garlic, crushed
- 1 tbsp light soy sauce
- 1½ tbsp hot sriracha sauce
- 1 tsp white wine vinegar
- 2 tbsp clear honey
- A little salt and freshly ground black pepper

### Vegetables:

- 1 red pepper, core and seeds removed
- 1 green pepper, core and seeds removed
- 100g red onion, peeled and thinly sliced
- 1 tbsp extra virgin olive oil

### Sriracha sauce:

- 4 heaped tbsp soured cream
- ½ tsp sriracha sauce
- Pinch salt

### To Serve:

- 4 regular flour tortillas, shredded iceberg lettuce, sliced tomatoes

### Method:

- 1 Prepare the marinade first: in a bowl, mix together the garlic, soy sauce, sriracha, vinegar, honey and season with a little salt and pepper. Stir in the chicken, cover and refrigerate for at least 30 minutes, longer if possible.
- 2 Drain the chicken of marinade and place in a foil parcel into the Rear Container.
- 3 Cut the pepper into strips and place in a mixing bowl with the onion. Add 1 tbsp oil and mix well. Remove the Dividing Wall from the Front Container and place the vegetables into it. Cover both Containers with the Lids.
- 4 Set the time for the chicken using the poultry preset (28 minutes) and adjust to 25 minutes. Set the time for the vegetables using the leaf and pod preset (16 minutes) and adjust to 15 minutes. Press the Start/Pause Button.
- 5 Meanwhile, mix the sauce ingredients together in a small serving dish, shred the lettuce and slice the tomatoes.
- 6 To serve, discard the liquid from the chicken. Divide the chicken and vegetables between the tortilla wraps, add salad and sauce and serve immediately.

## Vegetable Recipes

### Potato, Spinach and Chickpea Curry with Coconut Rice

Preparation time: 15 minutes plus marinating

Cooking time: 60 minutes

Serves: 2

#### Ingredients:

- 200g can chopped tomatoes
- 100g onion, very finely chopped
- 2 garlic cloves, crushed
- 1 tbsp fresh ginger, finely grated
- ¼ level tsp salt
- 1½ level tsp hot chilli powder
- 1 level tsp cumin
- 1 level tsp turmeric
- 200g peeled Maris Piper potatoes, cut into 10mm cubes
- 400g can chickpeas, drained and rinsed
- 100ml light coconut milk

#### Rice:

- 100g basmati rice, rinsed and drained
- 150ml light coconut milk
- 130g baby spinach leaves

To Serve:

- Natural yogurt and naan bread.

#### Method:

- 1 In a non-metallic bowl, mix the chopped tomatoes with the onion, garlic, ginger, salt and spices.
- 2 Add the potatoes and chick peas, cover with cling film and refrigerate for 30 minutes.
- 3 Stir in 100ml of the coconut milk then transfer the tomato mixture to the Rice Tray and place in the Rear Container.
- 4 Put the Dividing Wall into the Front Container. Put the rice and 150ml coconut milk into a Small Pot, stir well and place in one compartment. Put the baby spinach into the other compartment. Cover both Containers with the Lids.
- 5 Set time for curry using root vegetables preset (28 mins) and adjust to 60 minutes. Set time for rice using rice preset (40 minutes), adjust to 28 minutes. Then set the time for the spinach using the leaf and pod preset (16 minutes), adjust to 12 minutes. Press the Start/Pause Button.
- 6 When ready, gently stir the spinach through the curry, fork up the rice and serve with natural yogurt and naan bread.

### Sweet Red Peppers Stuffed with Leeks and Feta Cheese with Spring Onion and Pine Nut Couscous

Preparation time: 25 minutes

Cooking time: 20 minutes

Serves: 2

#### Ingredients:

- 2 x 110g sweet long red peppers
- 80g white part of leek, finely chopped
- 1 tbsp parsley, chopped
- 1 tbsp olive oil
- 10g Parmesan cheese, finely grated
- 10g fresh white breadcrumbs
- 50g feta cheese, finely crumbled
- Salt and freshly ground black pepper

#### Couscous:

- 100g couscous
- 1 level tsp vegetable stock powder
- 90ml water
- 20g spring onions, finely chopped
- 10g pine nuts

Garnish:

- Parsley sprigs

#### Method:

- 1 Remove the tops from the peppers. Then split the peppers lengthways taking care not to cut in half. Remove the core and seeds and discard.
- 2 Mix together leek, parsley and olive oil, then add the Parmesan and breadcrumbs. Mix in the feta cheese and season with salt and pepper to taste.
- 3 Stuff the mixture into the peppers.
- 4 Remove the Dividing Wall from the Front Container and place the peppers inside.
- 5 Put the couscous, vegetable powder and the water into the Rice Tray. Stir in the spring onions and pine nuts. Put the Rice Tray in the Rear Container and cover both Containers with the Lids.
- 6 Set time for couscous using the rice preset (40 minutes) and adjust to 20 minutes. Set time for peppers using the leaf and pod preset (16 minutes) and adjust to 20 minutes. Press the Start/Pause Button.
- 7 When cooked allow to stand for 5 minutes. Fluff up the couscous with a fork and garnish with the parsley.

## Singapore Noodles with a Hot Chilli Sauce

Preparation time: 20 minutes

Cooking time: 20 minutes

Serves 2

Ingredients:

- 2 x 150g sachets straight to wok thread fine noodles
- 2 tsp mild curry powder
- 2 tbsp water

**Vegetables:**

- 100g onion, sliced
- 80g red pepper, sliced
- 80g yellow pepper, sliced
- 100g mangetout
- 50g cashew nuts
- 2 cloves garlic, crushed
- 2 tbsp sesame oil

**Sauce:**

- 2 tbsp light soy sauce
- 3 tbsp sriracha hot chilli sauce
- 4 tbsp lime juice
- 2 tsp clear honey

**Method:**

- 1 Gently loosen the noodles and put into the Rice Tray. Sprinkle on the curry powder and add the water. Mix gently. Put into the Rear Container.
- 2 Put the onion, peppers, mangetout, cashew nuts and garlic in a mixing bowl and add the sesame oil. Stir well so that all the vegetables are coated. Fit the Dividing Wall to the front container and put the vegetables in one compartment.
- 3 Mix the sauce ingredients in a Small Pot and place in the other compartment. Cover both Containers with the Lids.
- 4 Set the time for the noodles using the rice preset (40 minutes) and adjust to 15 minutes. Set the time for the vegetables using the leaf and pod preset (16 minutes). Set the time for the sauce using the sauce preset (30 minutes) and adjust to 20 minutes. Press the Start/Pause Button.
- 5 When ready, gently stir the noodles and divide between two plates. Stir the hot chilli sauce then spoon 1 tbsp over the noodles. Serve the vegetables on top with another spoonful or two of the sauce according to taste.

## Dessert Recipes

### Cinnamon Pears

Preparation time: 5 minutes

Cooking time: 22 minutes

Serves: 2

**Ingredients:**

- 2 firm pears
  - 1 tbsp lemon juice
  - A little cinnamon
- To Serve:
- Crème fraiche or fresh single cream

**Method:**

- 1 Peel the pears, cut in half lengthways and remove the core.
- 2 Brush all over with a little lemon juice and then place on tin foil with the cut side uppermost.
- 3 Sprinkle each pear half with a little cinnamon. Make a foil parcel and place in the Rear Container. Cover the Container with the Lid.
- 4 Set the time for the pears using the leaf and pod preset (16 minutes) adjust to 22 minutes. Press the Start/Pause Button.
- 5 When ready serve warm or cold with a little of the juice from the foil and fresh cream or crème fraiche.

### Ginger and Banana Sponge Pudding with Sticky Toffee Sauce

Preparation time: 25 minutes

Cooking time: 35 minutes

Serves: 2

**Ingredients:**

- 1 piece stem ginger in syrup, plus 2 tbsp syrup from the jar
- 35g softened unsalted butter, plus extra for greasing
- 35g light muscovado sugar
- 1 medium egg, beaten
- ¼ tsp vanilla extract
- 35g self-raising flour
- ¼ level tsp ground ginger
- Pinch salt
- 80g ripe banana, mashed
- 1½ tbsp golden syrup

**Sauce:**

- 10g unsalted butter
- 10g light muscovado sugar
- 1½ tbsp golden syrup

To Serve:

- Vanilla ice cream or custard

**Method:**

- 1 Lightly grease 2 x 200ml ramekins.

- 2 Slice the stem ginger thinly and put into the bottom of the ramekins, then spoon 1 tbsp stem ginger syrup into each ramekin to cover the base.
- 3 In a mixing bowl, cream together the butter and sugar until light and fluffy. Gradually beat in the egg, then stir in the vanilla extract.
- 4 Sieve in the flour, ginger and salt and fold in the flour with a metal tablespoon. Stir in the mashed banana.
- 5 Spoon the creamed mixture into each ramekin and level the tops. Cover tightly with pieces of greased foil.
- 6 Put the ramekins in the Rear Container.
- 7 Position the Dividing Wall in the Front Container then prepare the sauce: Put the butter, sugar and golden syrup in the Small Pot and place in one compartment. Cover both Containers with the Lids.
- 8 Set time for puddings using the sauce preset (30 minutes) and adjust to 35 minutes. Set the time for the sauce using the sauce preset (30 minutes) and press the Start/Pause Button.
- 9 When ready remove the ramekins from the Rear Container using oven gloves and run a knife around the ramekin edge to loosen the puddings. Then put a side plate over the top of each pudding and invert. Put the plate on the work surface and very carefully remove the ramekin.
- 10 Stir the sauce thoroughly and spoon over each pudding. Serve warm with ice cream or custard.
- 6 Divide the mixture between the two moulds and place in the Rear Container. Cover the Container with the Lid.
- 7 Set the time using the sauce preset (30 minutes) and adjust to 17 minutes. Press the Start/Pause Button.
- 8 When ready remove the moulds from the Intellisteam container using oven gloves and leave to rest for 2 minutes on the work surface. Then put a side plate over the top of the fondant and invert. Put the plate on the work surface and very carefully remove the mould. Serve warm with cream or ice cream.

## Soft Berry Compote

Preparation time: 5 minutes

Cooking time: 11 minutes

Serves 2

### Ingredients:

- 100g blueberries
- 100g strawberries, hulled and halved lengthways
- 100g blackberries
- 100g raspberries
- 1 level tbsp caster sugar

### To Serve:

- Crème fraiche, ice cream or fresh cream

### Method:

- 1 Put the fruit in the Rice Tray and sprinkle on the sugar.
- 2 Place in the Rear Container and cover the Container with the Lid.
- 3 Set the time using the leaf and pod preset (16 minutes) and adjust to 11 minutes. Press the Start/Pause Button.
- 4 When ready gently spoon the juices over the fruit.
- 5 Serve warm or cold with crème fraiche, ice cream or cream.

## Chocolate Fondant

Preparation time: 15 minutes

Cooking time: 17 minutes plus 2 minutes resting

Serves: 2

### Ingredients:

- 50g unsalted butter, plus a little extra for greasing
- ½ tbsp cocoa
- 50g dark chocolate (85% cocoa)
- 1 medium egg and 1 egg yolk
- 50g caster sugar
- 1 level tbsp plain flour

### To Serve:

- Cream or ice cream

### Method:

- 1 Grease the inside of two 200ml pudding moulds or ramekins.
- 2 Put the cocoa into one mould and evenly coat the sides and base, then tip into the other mould and repeat.
- 3 Put the butter and chocolate into a heatproof bowl and melt over a pan of simmering water. Don't allow the bottom of the bowl to touch the water. Stir occasionally then leave to cool.
- 4 Put the egg, egg yolk and sugar into a mixing bowl and whisk on high speed for 3½ -4 minutes until pale in colour and thickened enough to hold the trail of the whisk.
- 5 With a spatula, gently fold in the chocolate and butter mixture and then fold in the flour.

## Christmas Pudding

Preparation time: 30 minutes

Cooking time: 2 hours, plus 2 hours to reheat

Serves: 4

### Notes:

- This pudding is improved if made up to a month in advance and stored in the fridge until needed. It can be conveniently re-steamed straight from the fridge when required. However, if you don't have enough time to prepare the pudding in advance, 2 hours steaming is sufficient.
- You will need a pudding basin (not plastic) of approximately 750ml capacity. Make sure this will fit into the Rear Container with the lid fitted properly before you begin. If preferred, 4 individual non-stick dariale moulds, each of approximately 200ml capacity may be used. In this case, follow the recipe below but divide the mixture equally between the four moulds.

### Ingredients:

- 75g currants
- 50g raisins
- 50g sultanas
- 50g mixed peel
- 1½ tbsp brandy
- 1 tsp mixed spice
- 25g plain flour
- Pinch salt
- 50g fresh white breadcrumbs
- 50g dark brown soft sugar
- 50g suet
- Zest of ½ lemon
- 1 medium egg, beaten
- 2 tbsp milk
- 2 level tbsp black treacle

### Method:

- 1 Grease the pudding basin and place a circle of non-stick baking paper into the base.
- 2 Put the dried fruit into a mixing bowl and stir in the brandy.
- 3 Stir in all the remaining ingredients, mix well and then place into the prepared basin, lightly press down the mixture and level the surface.
- 4 Cover the pudding with a double layer of non-stick baking paper, and then a layer of foil. Form around the basin and secure with string.
- 5 Place the basin into the Rear Container and cover the Container with the Lid.
- 6 Set the time for the pudding using the rice preset (40 minutes) and adjust to 60 minutes. Press the Start/Pause Button.
- 7 When an hour has elapsed, the Intellisteam will beep and switch onto Keep Warm. Cancel this by pressing the Start/Pause Button and then reset as point 6 above for a further 60 minutes, topping up the water level in the Water Tank if necessary.

- 8 To serve the pudding, remove from the Rear Container using oven gloves and leave to stand for 5 minutes before carefully running a palette knife around the edge of the basin, invert onto a serving plate, remove the baking paper circle and then serve with white sauce or brandy butter as desired.
- 9 To store, leave the pudding until cold, then remove the paper and foil, re-cover with fresh paper and foil as before and secure with string. Store the pudding in the fridge for up to one month.
- 10 When ready to use, reheat straight from the fridge and steam in the Rear Container as detailed above for 2 hours.

## Contact Us

### Helpline

If you are having a problem with your appliance, please call our Helpline, as we are more likely to be able to help than the retailer you purchased the item from.

Please have the product name, model number and serial number to hand when you call to help us deal with your enquiry quicker.

AUS

### Talk To Us

If you have any questions or comments, or want some great tips or recipe ideas to help you get the most out of your products, join us online:

**Blog:** [www.morphyrichards.co.uk/blog](http://www.morphyrichards.co.uk/blog)

**Facebook:** [www.facebook.com/morphyrichardsuk](https://www.facebook.com/morphyrichardsuk)

**Twitter:** [@loveyourmorphy](https://twitter.com/loveyourmorphy)

**Website:** [www.morphyrichards.com](http://www.morphyrichards.com)

---

## THIS SECTION IS ONLY APPLICABLE FOR CUSTOMERS IN UK AND IRELAND

### REGISTERING YOUR TWO YEAR GUARANTEE

---

Your standard one year guarantee is extended for an additional 12 months when you register the product within 28 days of purchase with Morphy Richards. If you do not register the product with Morphy Richards within 28 days, your product is guaranteed for 1 year. To validate your 2 year guarantee register with us online at [www.morphyrichards.co.uk](http://www.morphyrichards.co.uk)

N.B. Each qualifying product needs to be registered with Morphy Richards individually. Please refer to the one year guarantee for more information.

### YOUR ONE YEAR GUARANTEE

---

It is important to retain the retailer's receipt as proof of purchase. Staple your receipt to this back cover for future reference. Please quote the following information if the product develops a fault. These numbers can be found on the base of the product.

Model no.  
Serial no.

All Morphy Richards products are individually tested before leaving the factory. In the unlikely event of any appliance proving to be faulty within 28 days of purchase, it should be returned to the place of purchase for it to be replaced. If the fault develops after 28 days and within 12 months of original purchase, you should contact the Helpline number quoting Model number and Serial number on the product, or write to Morphy Richards at the address shown. You may be asked to return a copy of proof of purchase. Subject to the exclusions set out below (see Exclusions), the faulty appliance will then be repaired or replaced and dispatched usually within 7 working days of receipt. If, for any reason, this item is replaced during the 1 year guarantee period, the guarantee on the new item will be calculated from original purchase date. Therefore it is vital to retain your original till receipt or invoice to indicate the date of initial purchase. To qualify for the 1 year guarantee, the appliance must have been used according to the instructions supplied. For example, crumb trays should have been emptied regularly.

### EXCLUSIONS

---

Morphy Richards shall not be liable to replace or repair the goods under the terms of the guarantee where:

- 1 The fault has been caused or is attributable to accidental use, misuse, negligent use or used contrary to the manufacturer's recommendations or where the fault has been caused by power surges or damage caused in transit.
- 2 The appliance has been used on a voltage supply other than that stamped on the products.
- 3 Repairs have been attempted by persons other than our service staff (or authorised dealer).
- 4 The appliance has been used for hire purposes or non domestic use.
- 5 The appliance is second hand.

- 6 Morphy Richards are not liable to carry out any type of servicing work, under the guarantee.
- 7 Plastic filters for all Morphy Richards kettles and coffee makers are not covered by the guarantee.
- 8 Batteries and damage from leakage are not covered by the guarantee.
- 9 The filters have not be cleaned and replaced as instructed.

This guarantee does not confer any rights other than those expressly set out above and does not cover any claims for consequential loss or damage. This guarantee is offered as an additional benefit and does not affect your statutory rights as a consumer.

### YOUR INTERNATIONAL TWO YEAR GUARANTEE

---

This appliance is covered by two-year repair or replacement warranty.

It is important to retain the retailers receipt as proof of purchase. Staple your receipt to this back cover for future reference.

Please quote the following information if the product develops a fault. These numbers can be found on the base of the product.

Model no.  
Serial no.

All Morphy Richards products are individually tested before leaving the factory. In the unlikely event of any appliance proving to be faulty within 28 days of purchase it should be returned to the place of purchase for it to be replaced.

If the fault develops after 28 days and within 24 months of original purchase, you should contact your local distributor quoting Model number and Serial number on the product, or write to your local distributor at the addresses shown.

You will be asked to return the product (in secure, adequate packaging) to the address below along with a copy of proof of purchase.

Subject to the exclusions set out below (1-9) the faulty appliance will then be repaired or replaced and dispatched usually within 7 working days of receipt.

If for any reason this item is replaced during the 2-year guarantee period, the guarantee on the new item will be calculated from original purchase date. Therefore it is vital to retain your original till receipt or invoice to indicate the date of initial purchase.

To qualify for the 2-year guarantee the appliance must have been used according to the manufacturers instructions. For example, appliances must have been descaled and filters must have been kept clean as instructed.

The local distributor shall not be liable to replace or repair the goods under the terms of the guarantee where:

- 1 The fault has been caused or is attributable to accidental use, misuse, negligent use or used contrary to the manufacturers recommendations or where the fault has been caused by power surges or damage caused in transit.
- 2 The appliance has been used on a voltage supply other than that

stamped on the products.

- 3 Repairs have been attempted by persons other than our service staff (or authorised dealer).
- 4 Where the appliance has been used for hire purposes or non domestic use.
- 5 The appliance is second hand.
- 6 The local distributor are not liable to carry out any type of servicing work, under the guarantee.
- 7 The guarantee excludes consumables such as bags, filters and glass carafes.
- 8 Batteries and damage from leakage are not covered by the guarantee.
- 9 The filters have not be cleaned and replaced as instructed.

This guarantee does not confer any rights other than those expressly set out above and does not cover any claims for consequential loss or damage. This guarantee is offered as an additional benefit and does not affect your statutory rights as a consumer.

## AUSTRALIAN WARRANTY

This appliance is guaranteed for 2 years against faulty material, components and workmanship.

This warranty is in addition and does not affect your statutory rights.

Proof of purchase must be produced for any warranty benefit.

In the unlikely event of any appliance proving to be faulty, securely pack and return the item to the place of purchase accompanied by the original receipt or invoice.

Our goods come with guarantees that cannot be excluded under the Australian Consumer Law. You are entitled to a replacement or refund for a major failure and for compensation for any other reasonably foreseeable loss or damage. You are also entitled to have the goods repaired or replaced if the goods fail to be of acceptable quality and the failure does not amount to a major failure.

## NOT COVERED BY THIS WARRANTY

*(Australian only)*

- If the appliance has not been used in accordance with the manufacturers' recommendations or Instructions.
- If the fault is deemed to be caused by abuse, misuse, neglect, modifications or in proper use and or care  
Eg: Kettles: Excessive build up of scale.  
Toasters: Excessive build up of crumbs or foreign matter etc.
- Connection to incorrect voltage to that stamped on the product.
- Unauthorised repairs.
- Appliance used other than for domestic purposes.
- Excluding bags, filters, glass, carafes, and cutting blades.
- Freight and insurance costs.

If for any reason this item is replaced during the 2 year guarantee period, the guarantee on the new item will be calculated from original purchase date. Therefore it is vital to retain your original receipt or invoice to indicate the date of original purchase.

Morphy Richards's policy is to continually improve quality design and product quality. The company therefore reserves the right to change any specifications or to carry out modifications as deemed worthy at any time.

The Australian supplier reserves the right to repair, modify, exchange or replace the faulty appliance with the same or similar model or product of equivalent value.

- 
- GB** Morphy Richards products are intended for household use only.  
Morphy Richards has a policy of continuous improvement in product quality and design.  
The Company, therefore, reserves the right to change the specification of its models at any time.

**The After Sales Division,**

Morphy Richards Ltd, Mexborough, South Yorkshire, England, S64 8AJ  
Helpline (office hours) UK 0845 871 0960 Republic of Ireland 1800 409119

- AUS** **Glen Dimplex Australia**  
1340 Ferntree Gully Road, Scoresby, Victoria 3179  
T : 1300 556 816  
E : sales@glendimplex.com.au

- NZ** **Glen Dimplex New Zealand**  
38 Harris Road, East Tamaki, Auckland, New Zealand  
T : 09 2748265  
E : sales@glendimplex.co.nz

**morphy richards®**

FS470006MAUS Rev 1 10/19

**www.morphyrichards.com**