

AH EPP

GAMING DESK

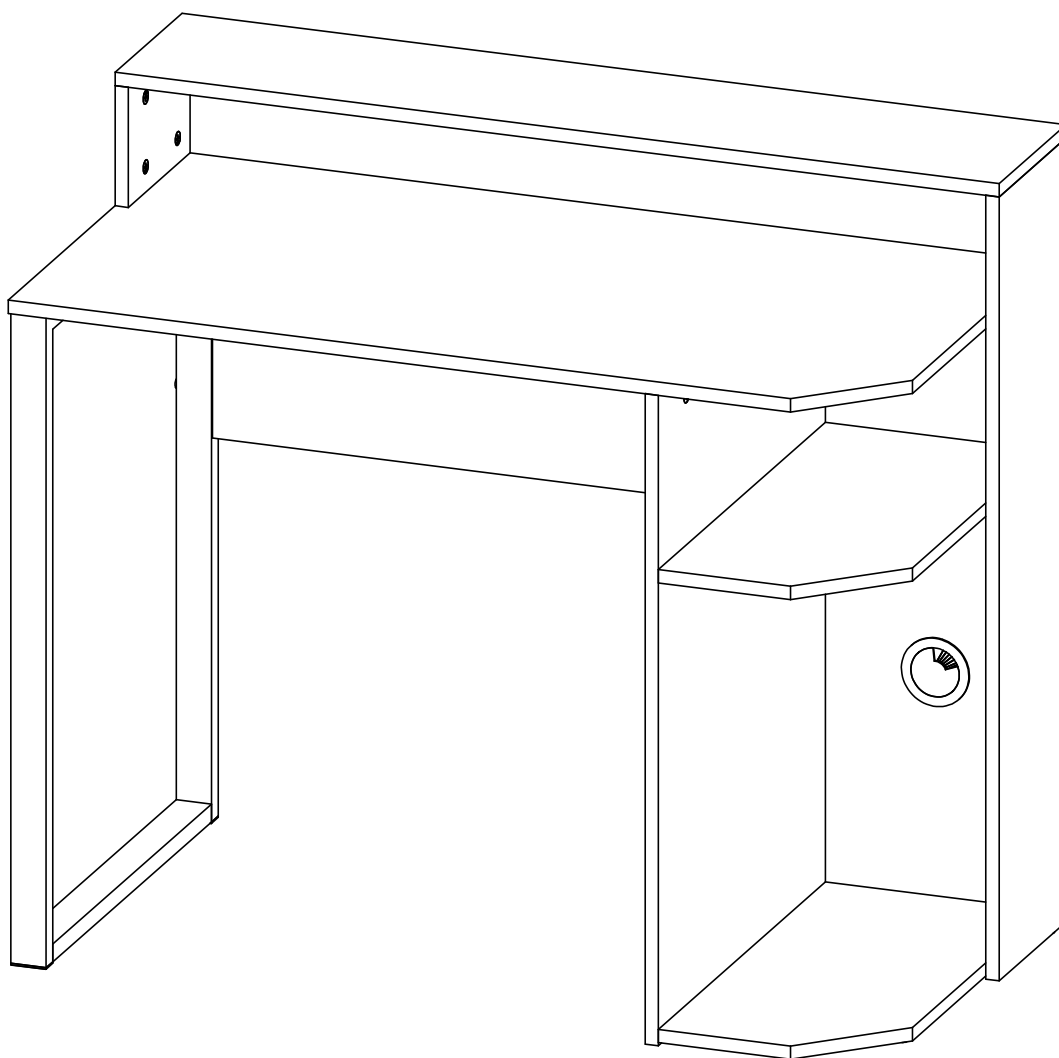

Spare Parts

 www.argos-support.co.uk

 Help@ClickSpares.co.uk

 0370 112 1928

Customer Support

 0345 640 2020

 argos.co.uk/help/contact-us



Safety and Care Advice

Product Details

AH EPP GAMING DESK 7699634

IMPORTANT, RETAIN FOR FUTURE REFERENCE: READ CAREFULLY.

- Keep children and animals away from the work area, small parts could choke if swallowed.
- Make sure you have enough space to layout the parts before starting.
- This product has been constructed to be used in the domestic environment only and not for commercial purposes.

- Assemble the item as close to its final position (in the same room) as possible.
- Assemble on a soft level surface to avoid damaging the unit or your floor.

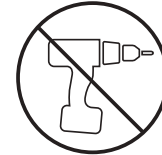

- We do not recommend the use of power drill/drivers for inserting screws as this could damage the unit. Only use hand screwdrivers.
- Parts of the assembly will be easier with 2 people.
- Dispose of all packaging carefully and responsibly.

Care and maintenance

- Only clean using a damp cloth and mild detergent. Do not use abrasive cleaners.
- Use a dry cloth to clean the product, furniture polish is not recommended.
- From time to time check that there are no loose screws, nuts or bolts. If there are please re-tighten.
- This product should not be discarded with household waste. Take to your local authority waste disposal centre.

Additional Guidance

- Assemble all parts and bolts loosely during assembly, only once the product is complete should you fully tighten the bolts.
- Regularly check and ensure that all bolts and fittings are tightend properly.
- Maximum load weight : 50kgs.
- This product is compliant EN12521.

Fittings (shown to scale)

Bag 1

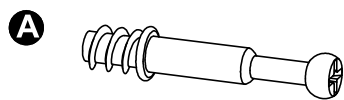

A
Camlock screw
(35mm) x 32

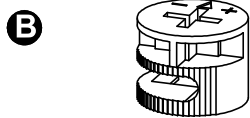

B
Camlock nut
(Ø15x12mm) x32

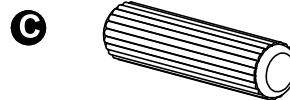

C
Plastic dowel
(Ø7.8x30mm) x26

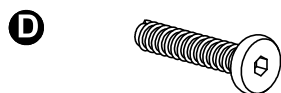

D
Bolt (M6x30mm) x 2

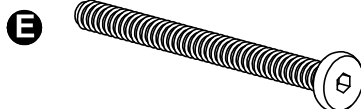

E
Bolt (M6x70mm) x 2

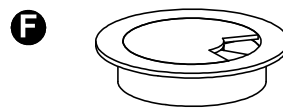

F
Wiring duot x1



G
Nut
(Ø10.5mm) x 2



H
Adjustable foot
(M6x10mm) x 1

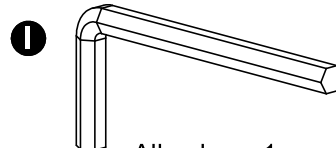

I
Allen key x1



J
Sticker x22

Panels

1 Top Panel x 1
(985x520mm)

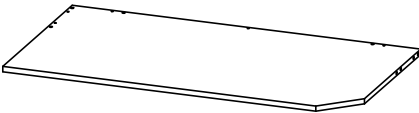

2 Middle Panel x 1
(730x520mm)

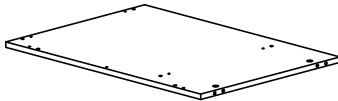

3 Shelf x 1
(500x250mm)

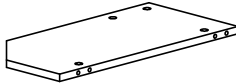

4 Shelf x 1
(500x250mm)

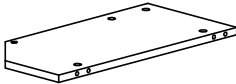

5 Side Panel x 1
(880x200mm)

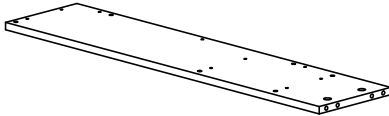

6 Bottom Panel x 1
(730x250mm)

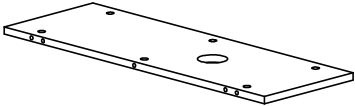

7 Bottom Panel x 1
(678x300mm)

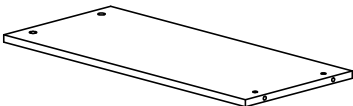

8 Bottom Panel x 1
(970x135mm)

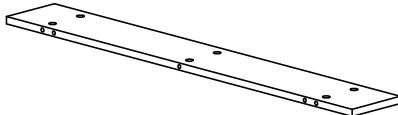

9 Side Panel x 1
(200x135mm)



10 Shelf X 1
(1000x200mm)

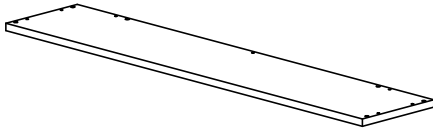

11 Leg x 1
(730x515mm)

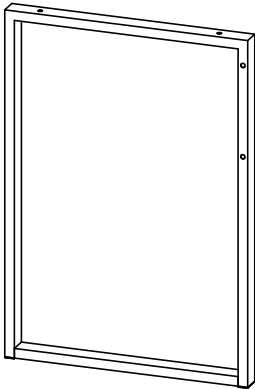

Tools required

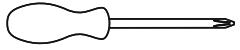

Phillips screwdriver
(small & medium)

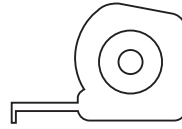

Ruler/tape
measure



Small
hammer

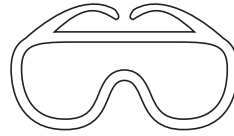

Eye protection
(when using a
hammer or glue)

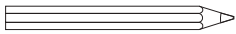

Pencil

1

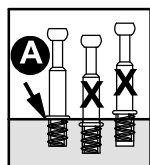
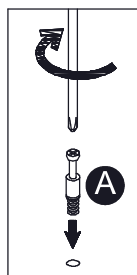
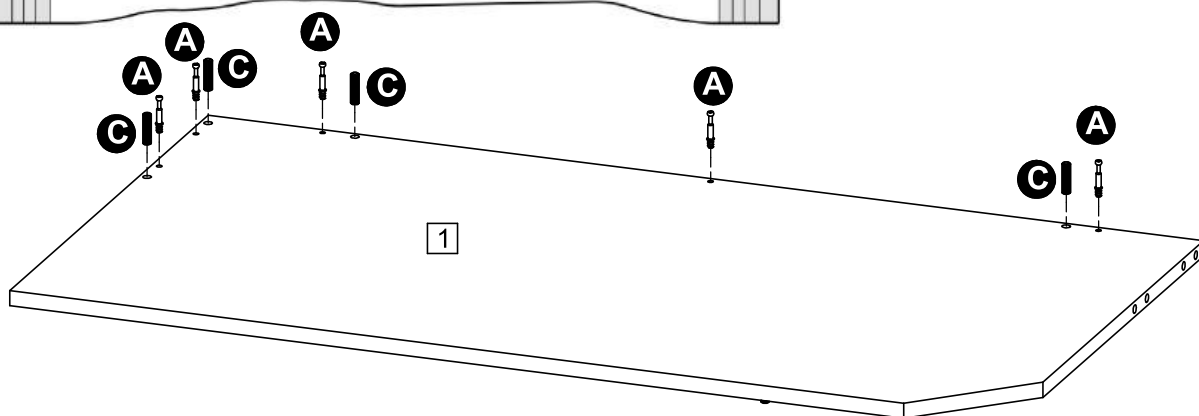
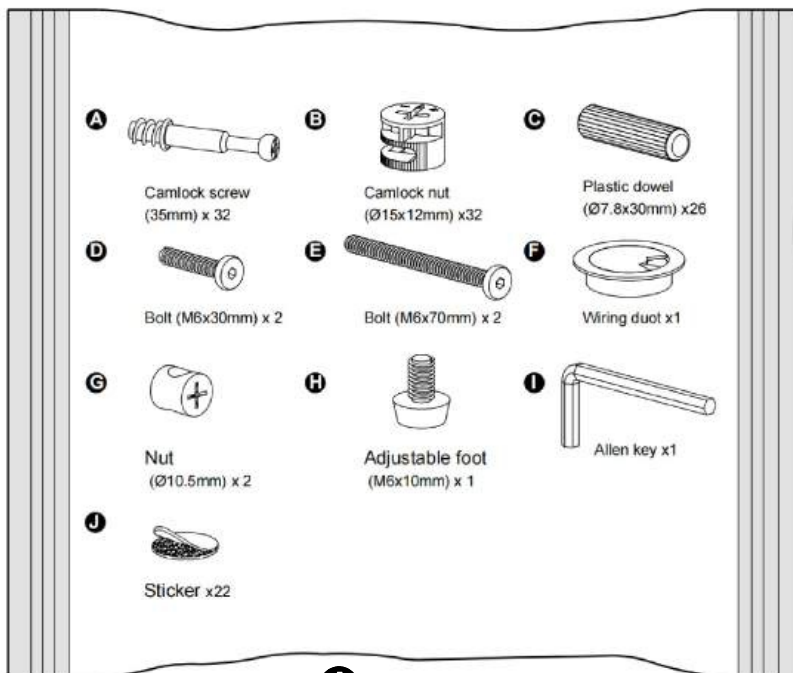

2

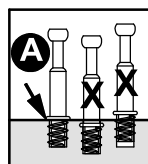
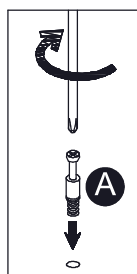
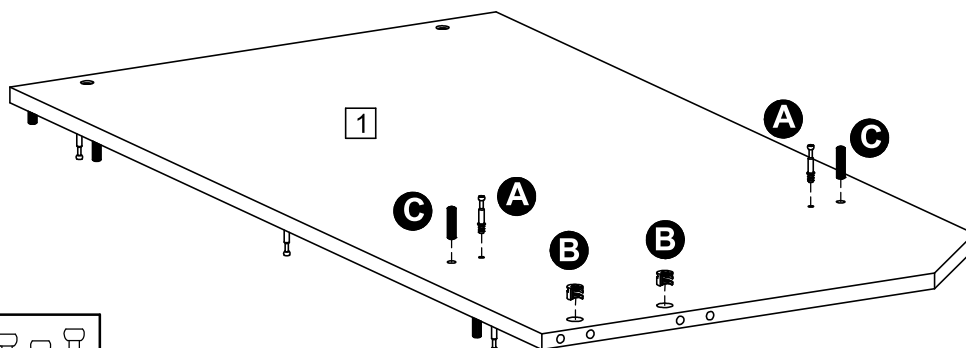
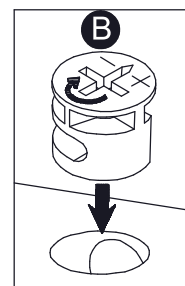
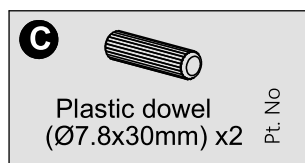
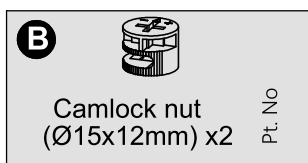
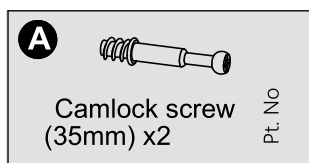

3

A 
Camlock screw
(35mm) x2 Pt. No

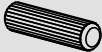
C 
Plastic dowel
(Ø7.8x30mm) x2 Pt. No

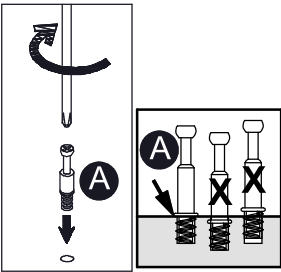
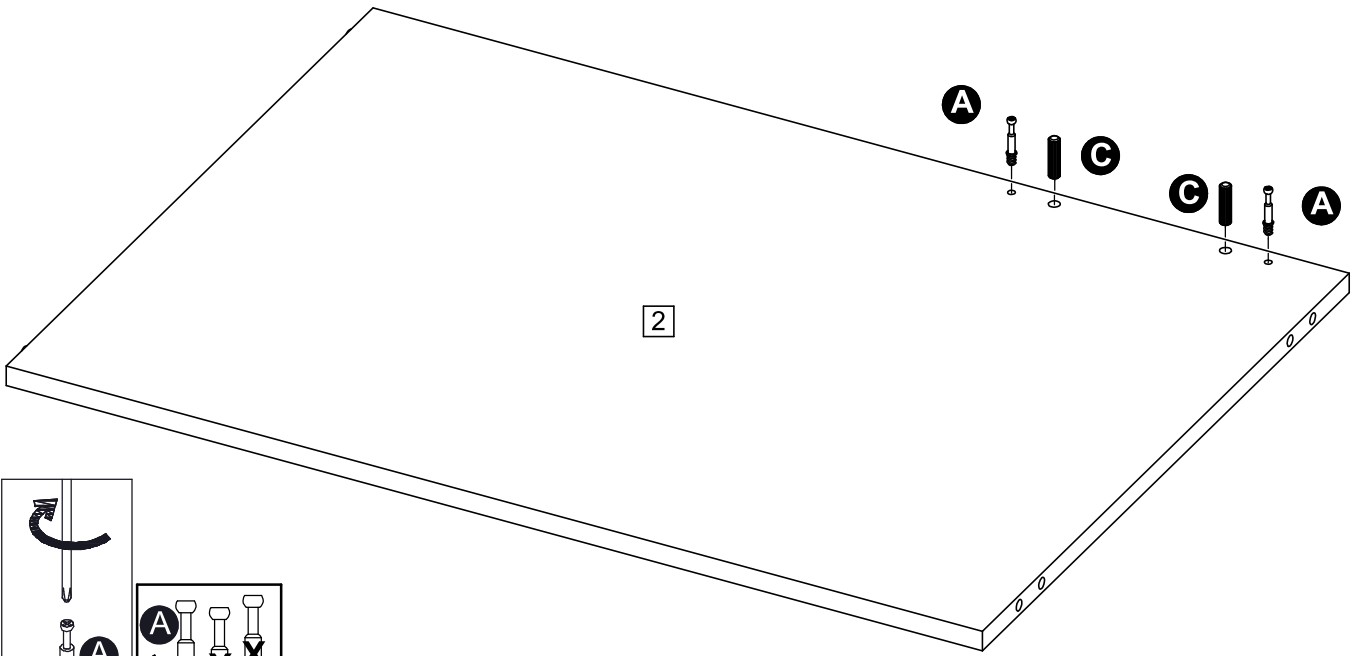

4

A 
Camlock screw
(35mm) x7 Pt. No

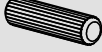
C 
Plastic dowel
(Ø7.8x30mm) x6 Pt. No

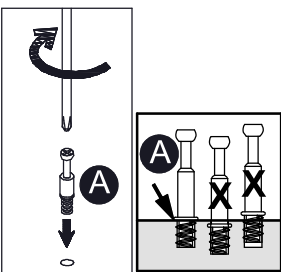
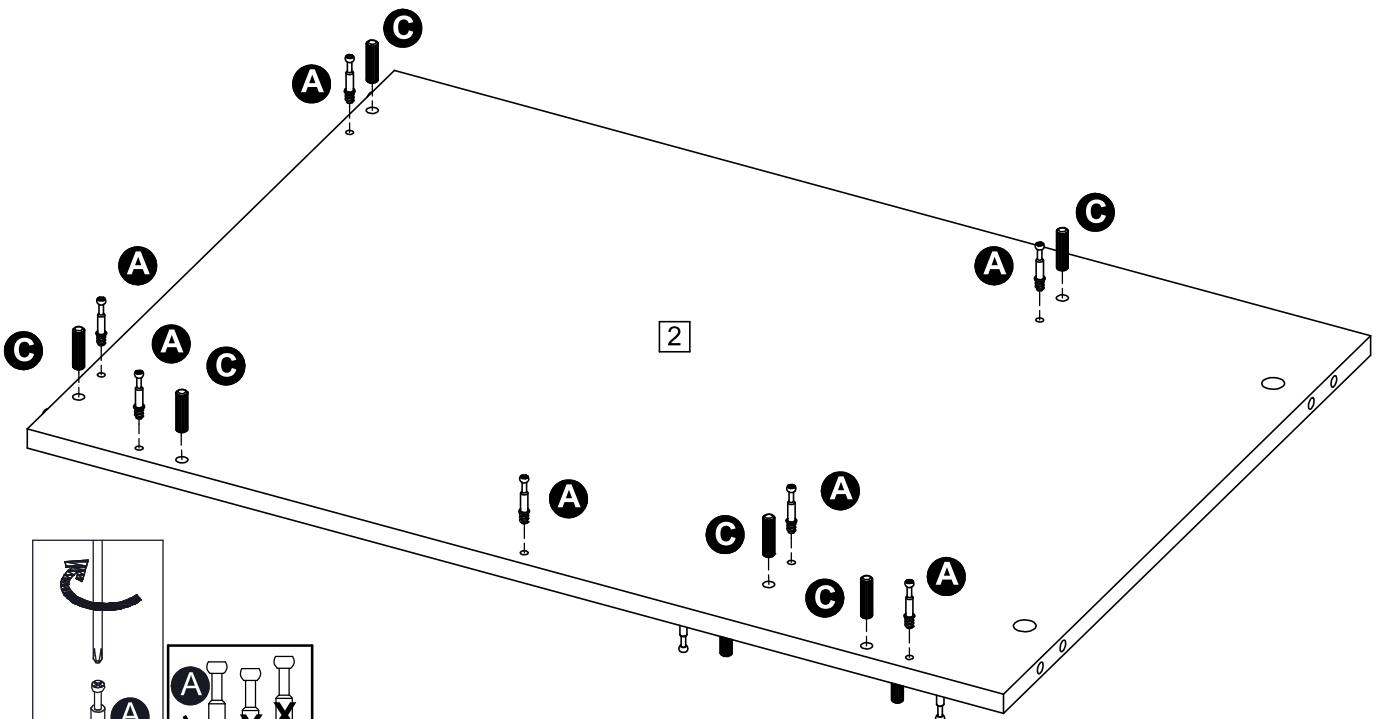

5

B 
Camlock nut
(Ø15x12mm) x 8 Pt. No

H 
Adjustable foot
(M6x10mm) x 1 Pt. No

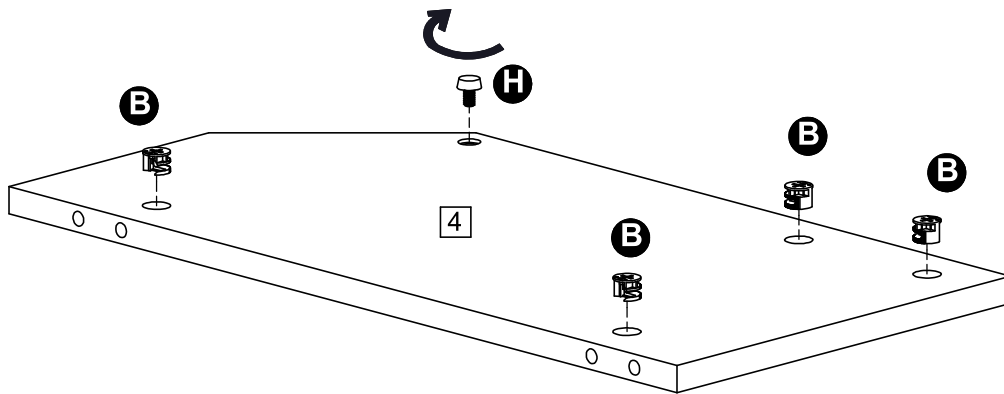
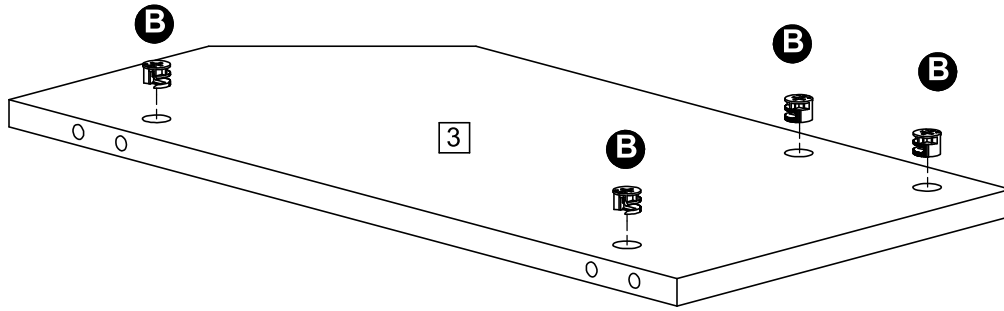
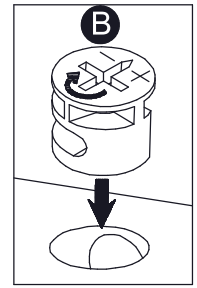

6

A 
Camlock screw
(35mm) x9 Pt. No

B 
Camlock nut
(Ø15x12mm) x 2 Pt. No

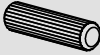
C 
Plastic dowel
(Ø7.8x30mm) x6 Pt. No

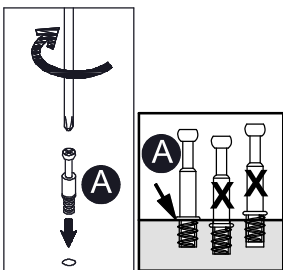
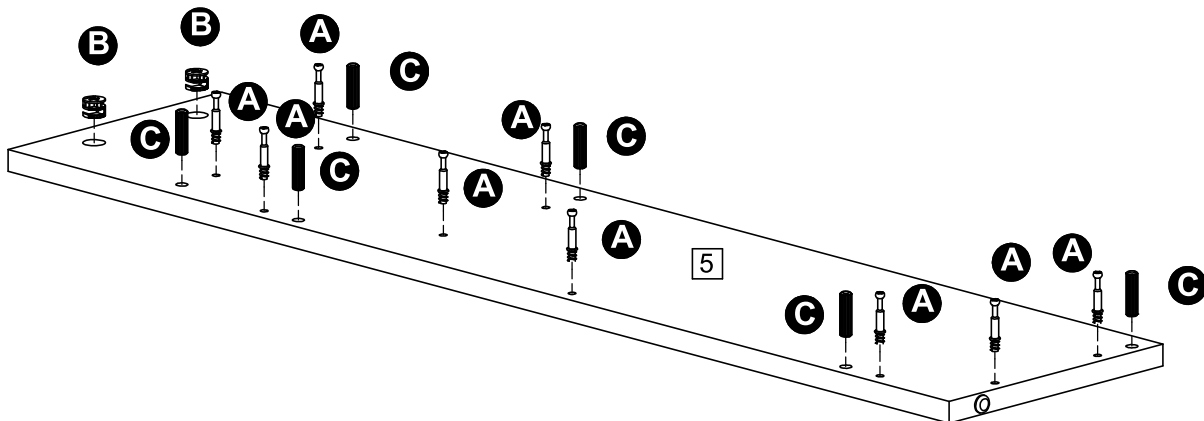
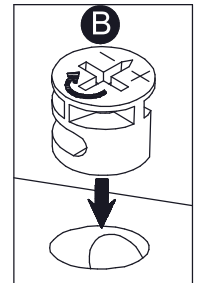

7

B 
Camlock nut
(Ø15x12mm) x10 Pt. No

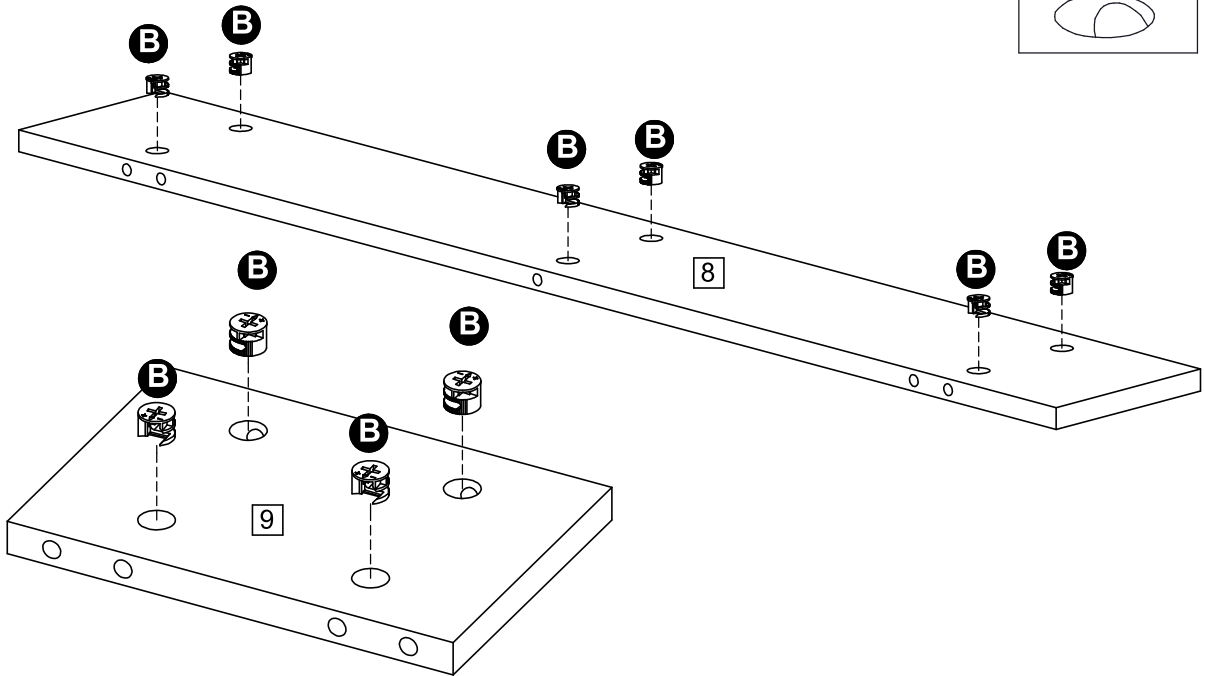
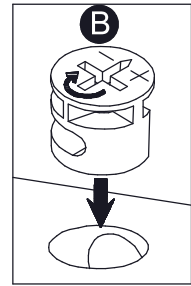

8

A 
Camlock screw
(35mm) x7 Pt. No

C 
Plastic dowel
(Ø7.8x30mm) x6 Pt. No

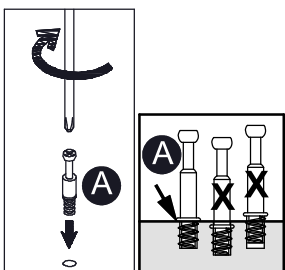
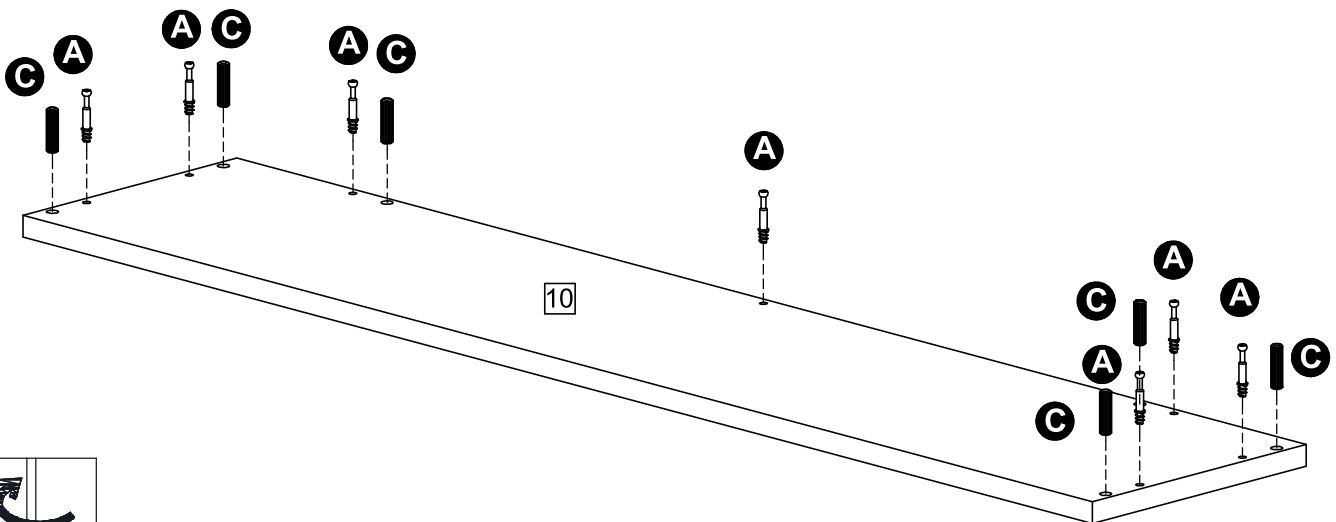

9

B  Camlock nut (Ø15x12mm) x2 Pt. No

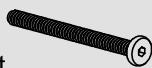
E  Bolt (M6x70mm) x 2 Pt. No

I  Allen key x1 Pt. No

J  Sticker x2 Pt. No

G  Nut x2 Pt. No

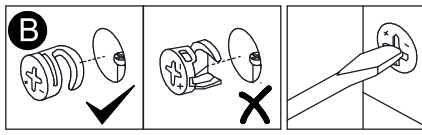
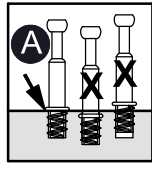
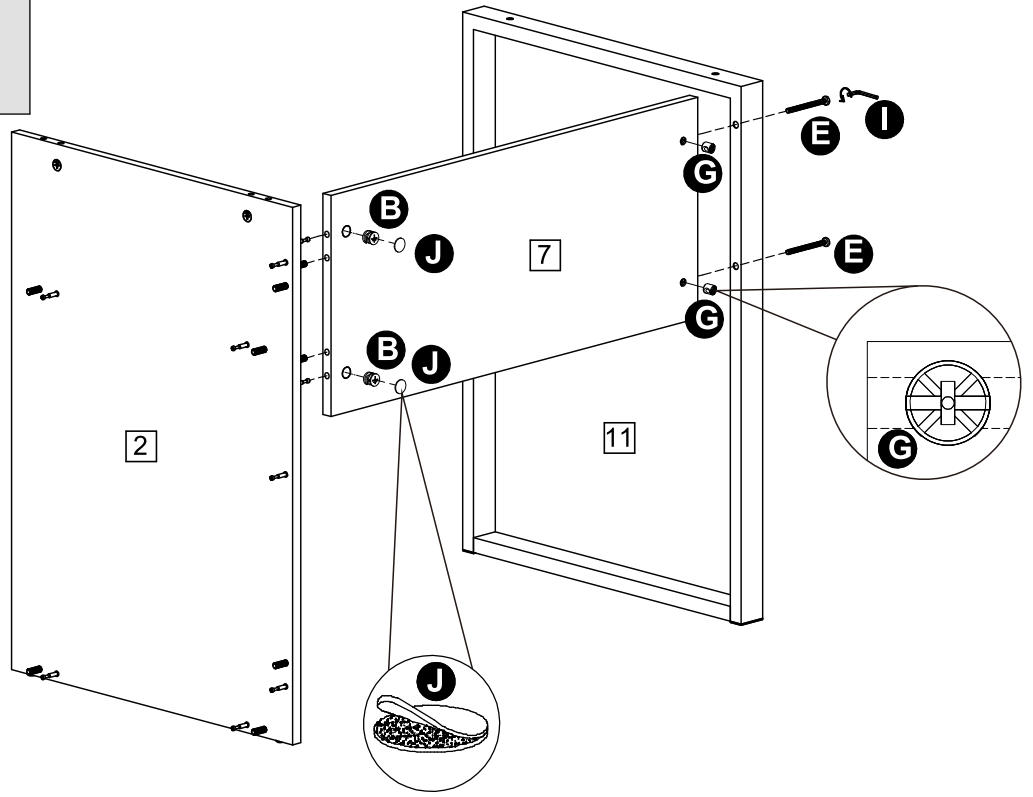

10

B  Camlock nut (Ø15x12mm) x 2 Pt. No

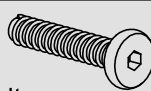
D  Bolt (M6x30mm) x 2 Pt. No

I  Allen key x1 Pt. No

J  Sticker x2 Pt. No

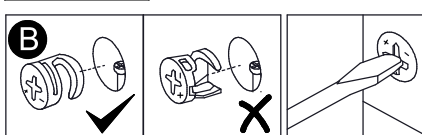
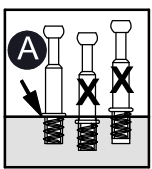
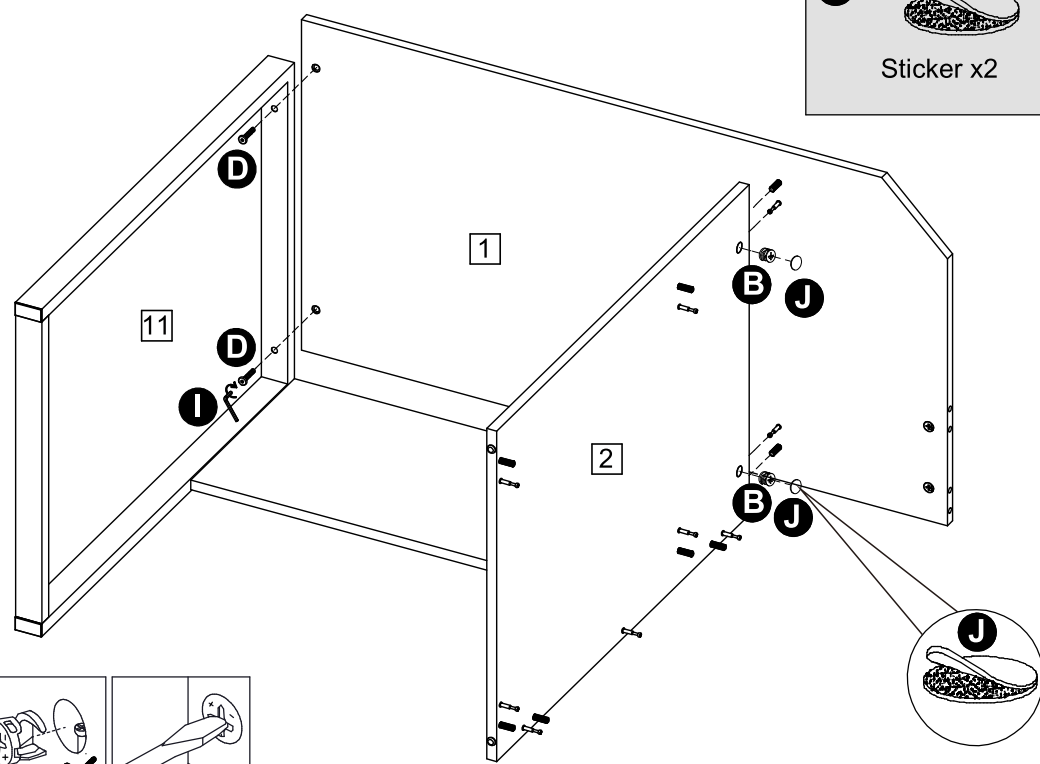

11

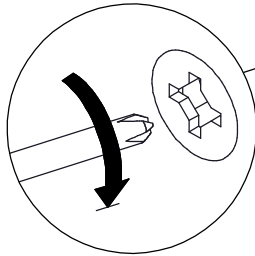
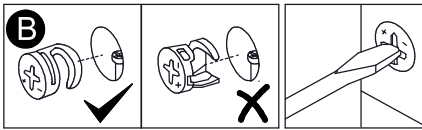
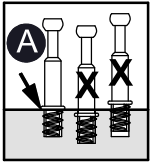
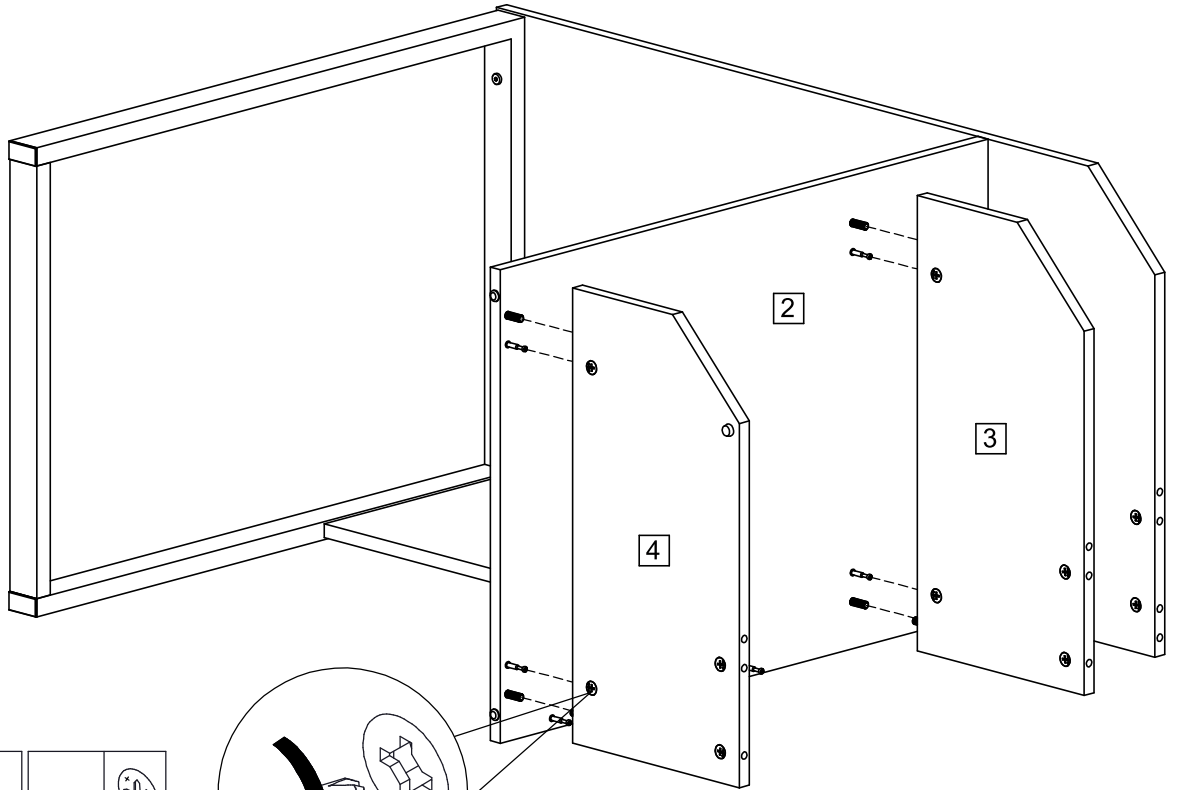

12

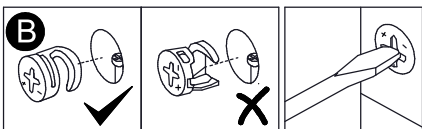
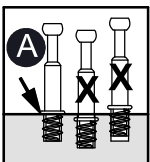
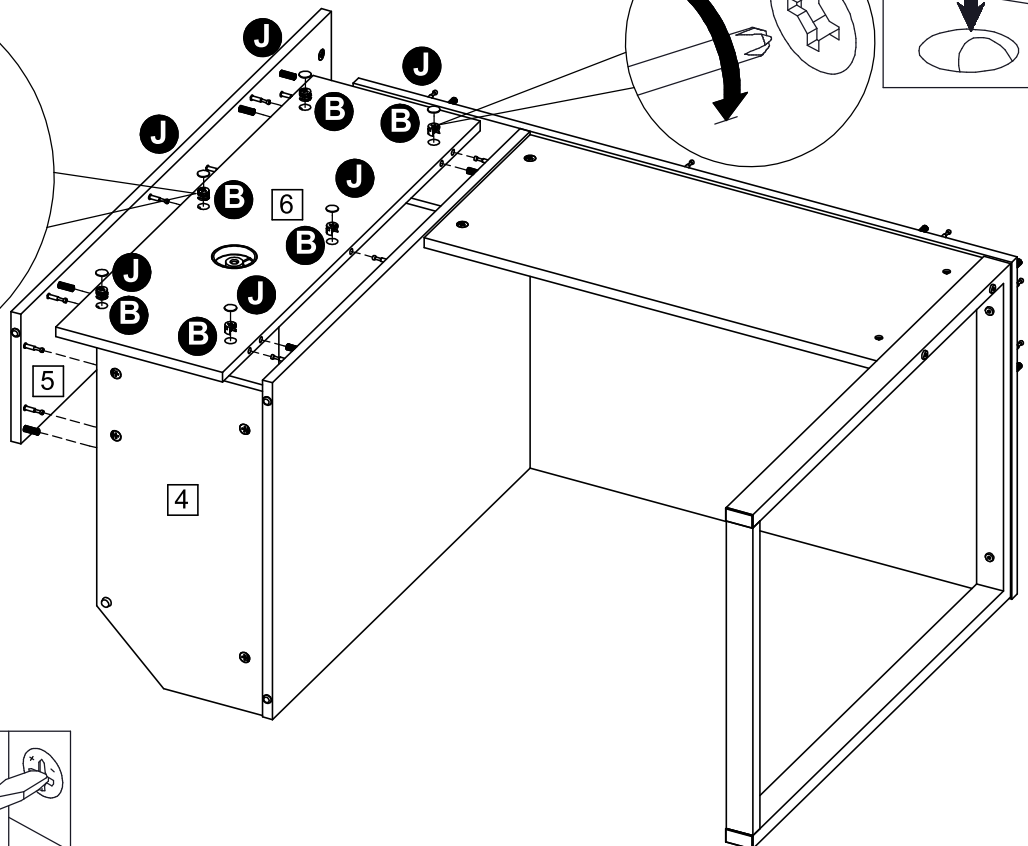
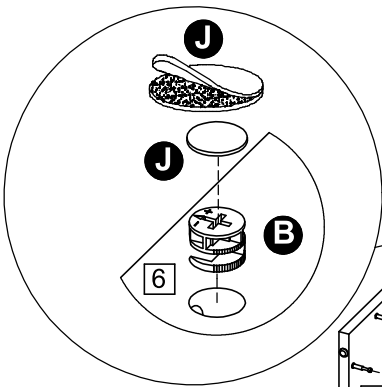
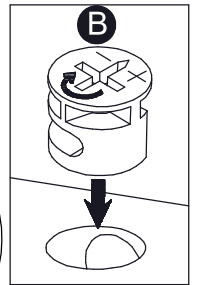
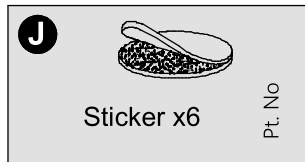

13

F 
Cable box
(φ60mm) x 1 Pt. No

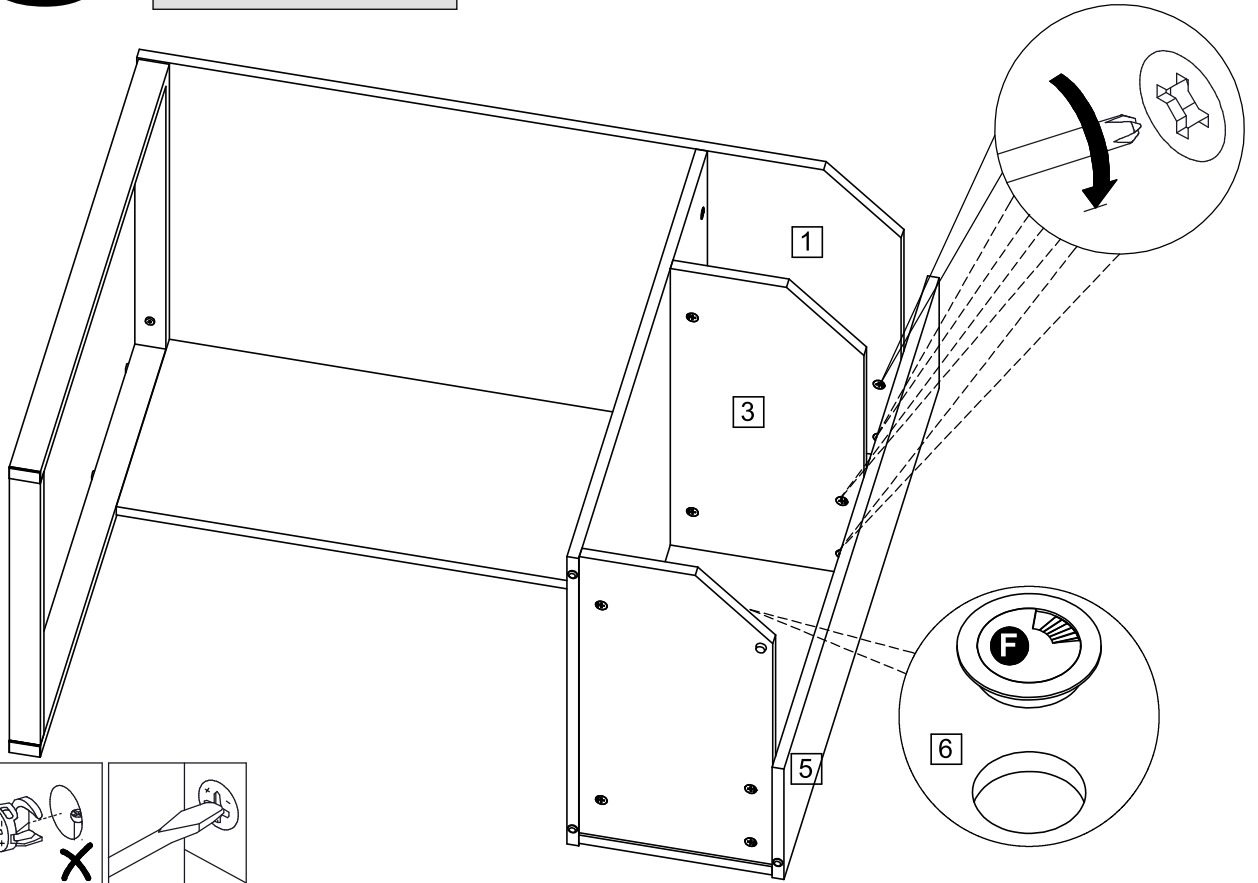
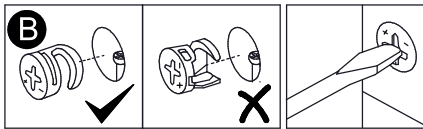
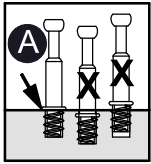

14

J 
Sticker x3 Pt. No

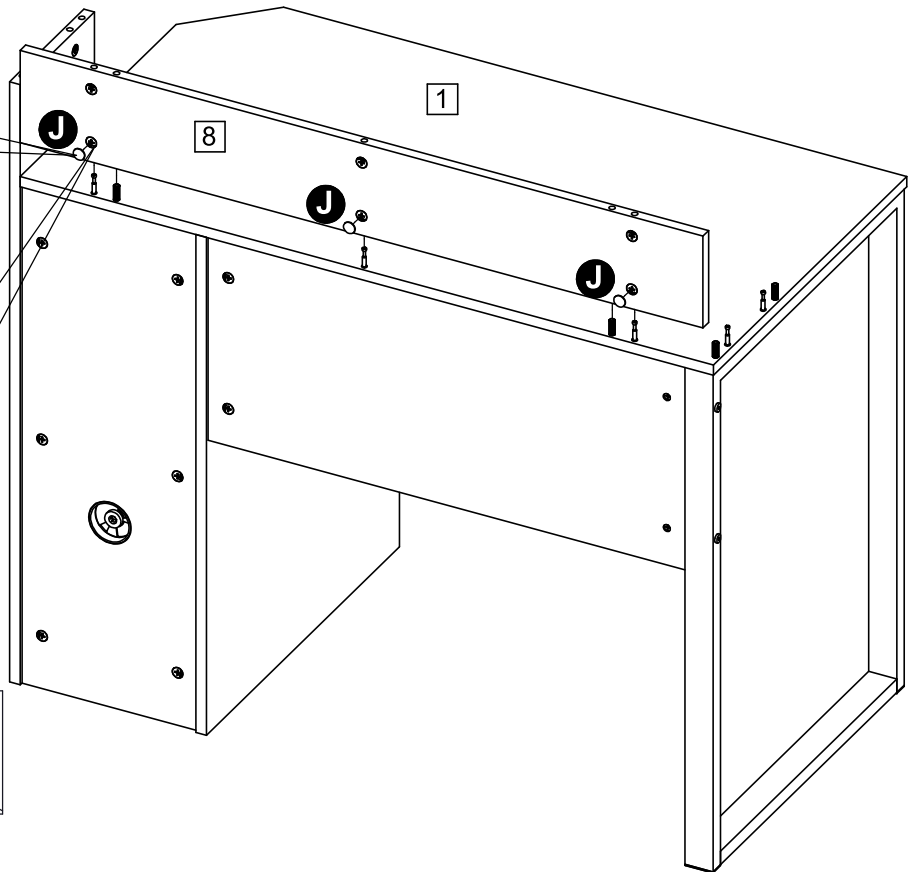
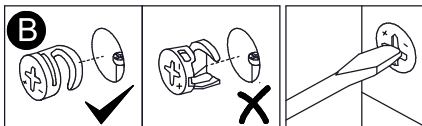
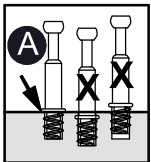
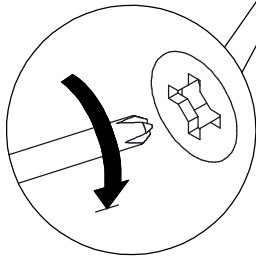
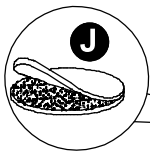

15

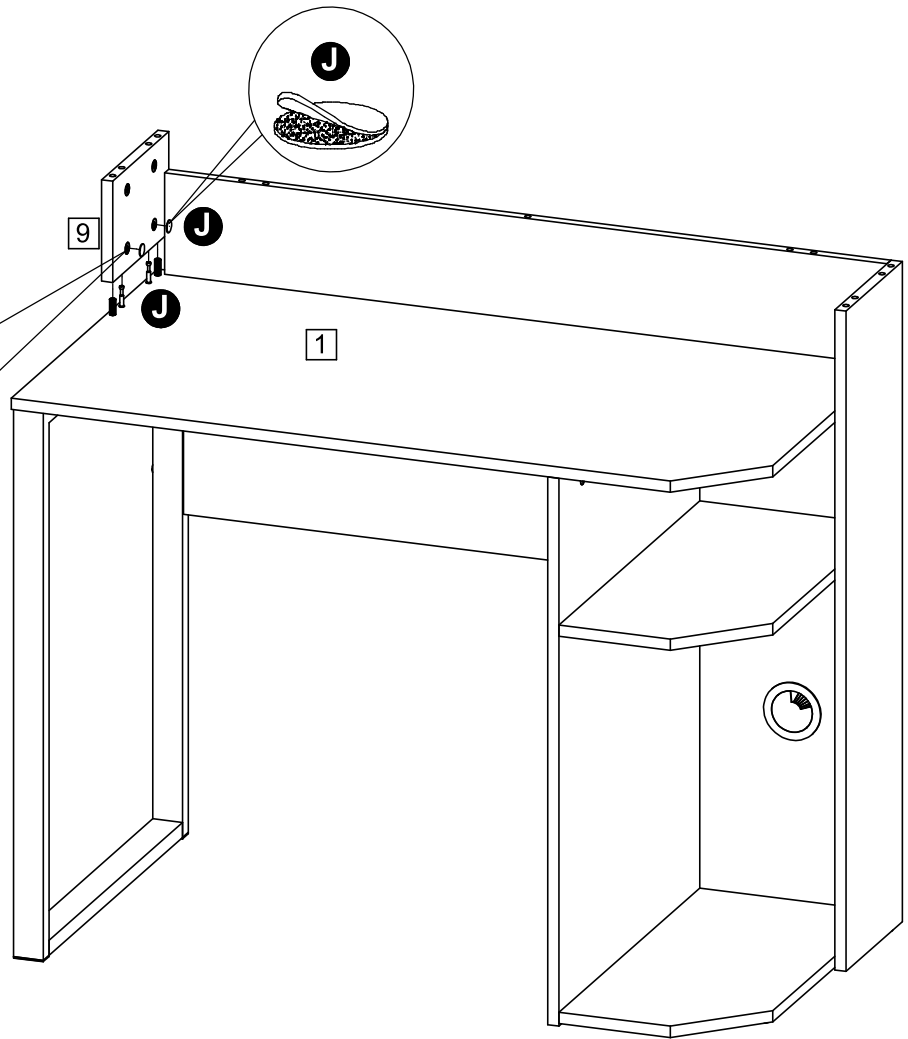
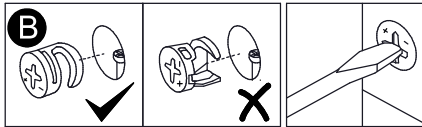
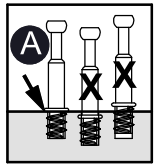
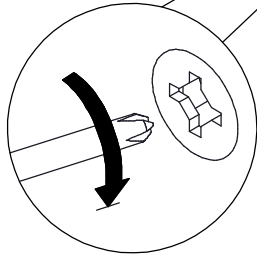
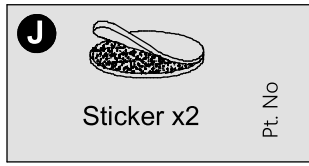

16

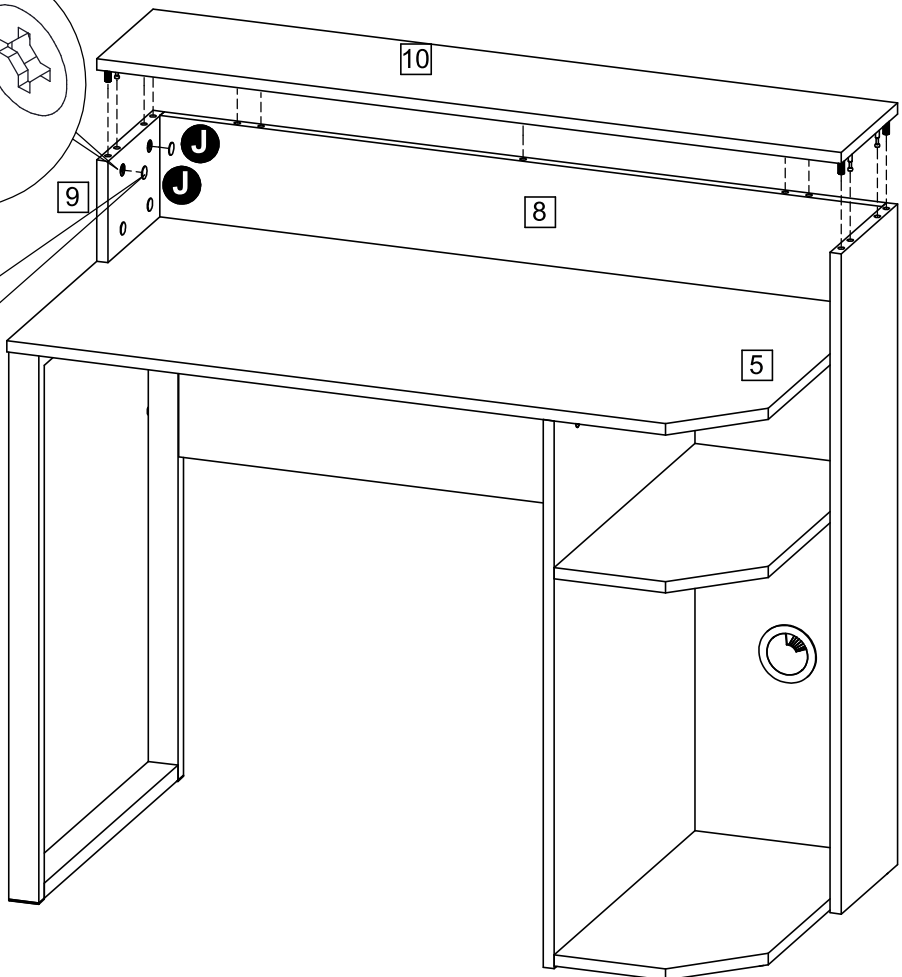
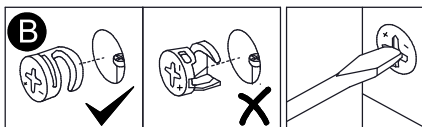
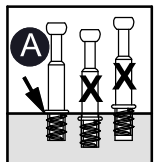
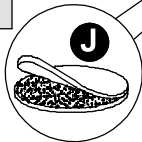
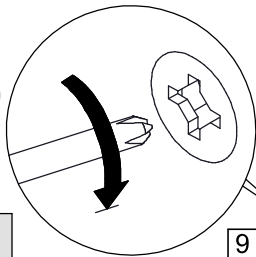
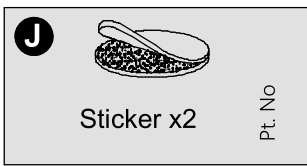

17

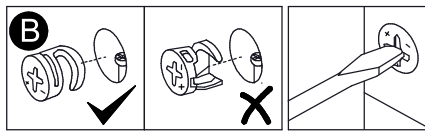
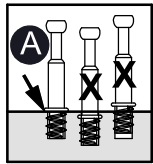
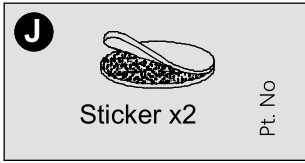
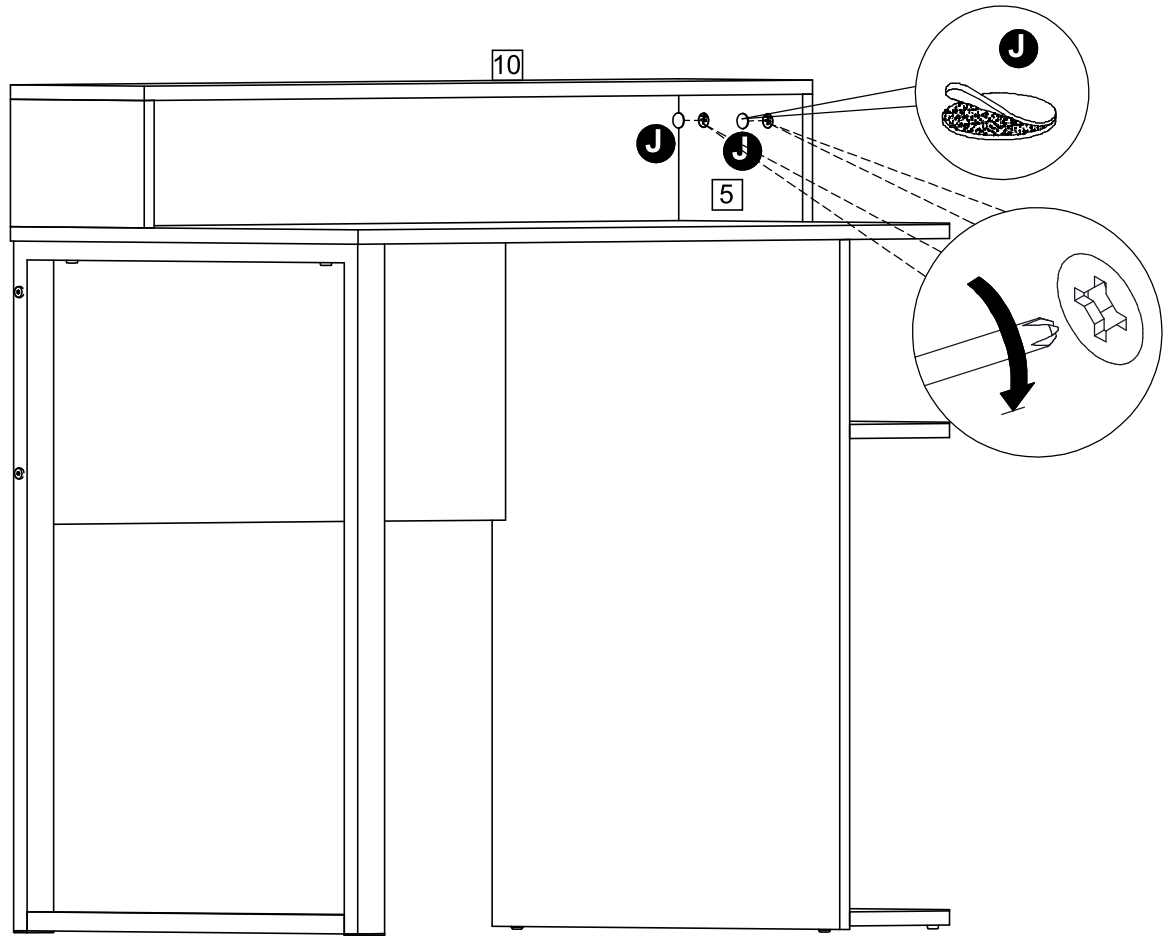

18

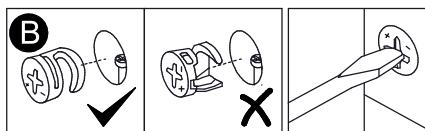
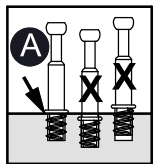
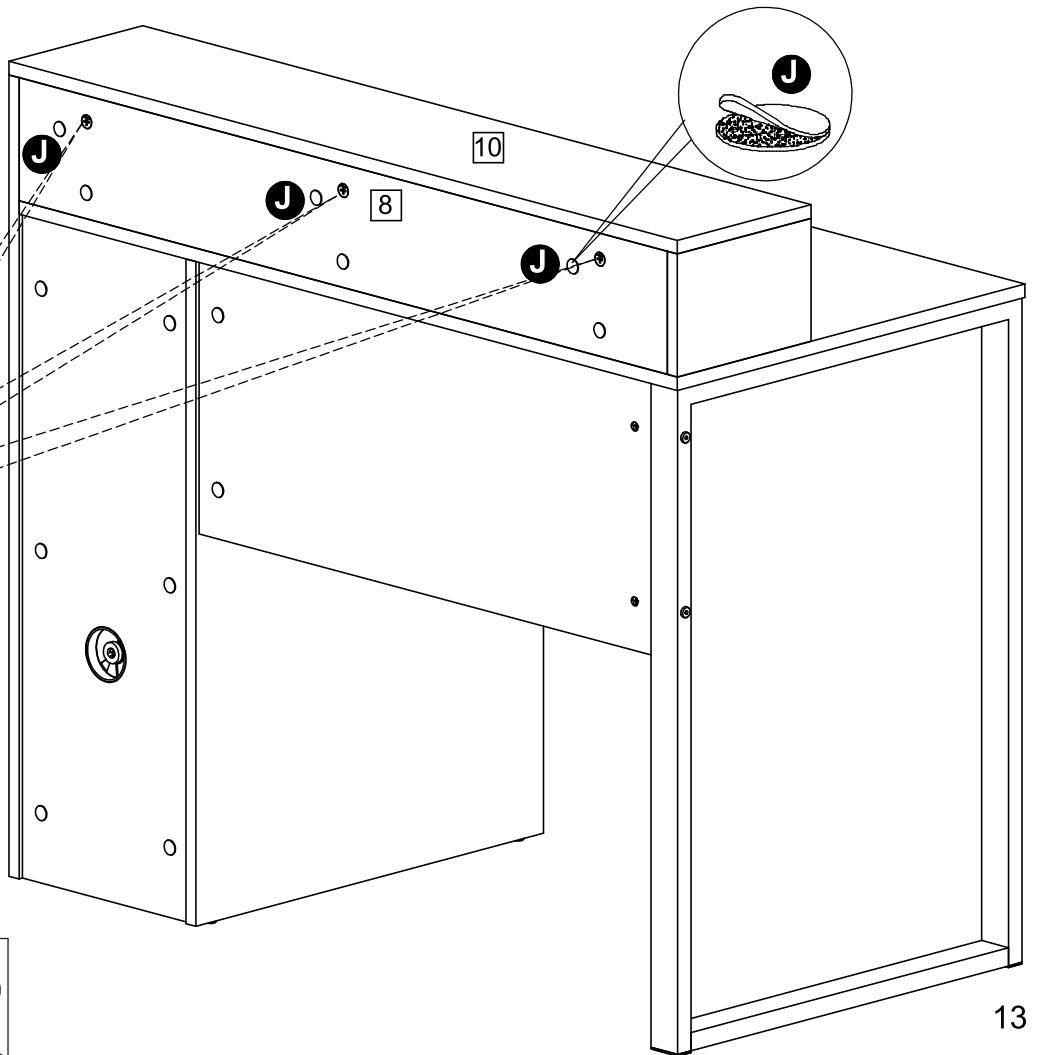

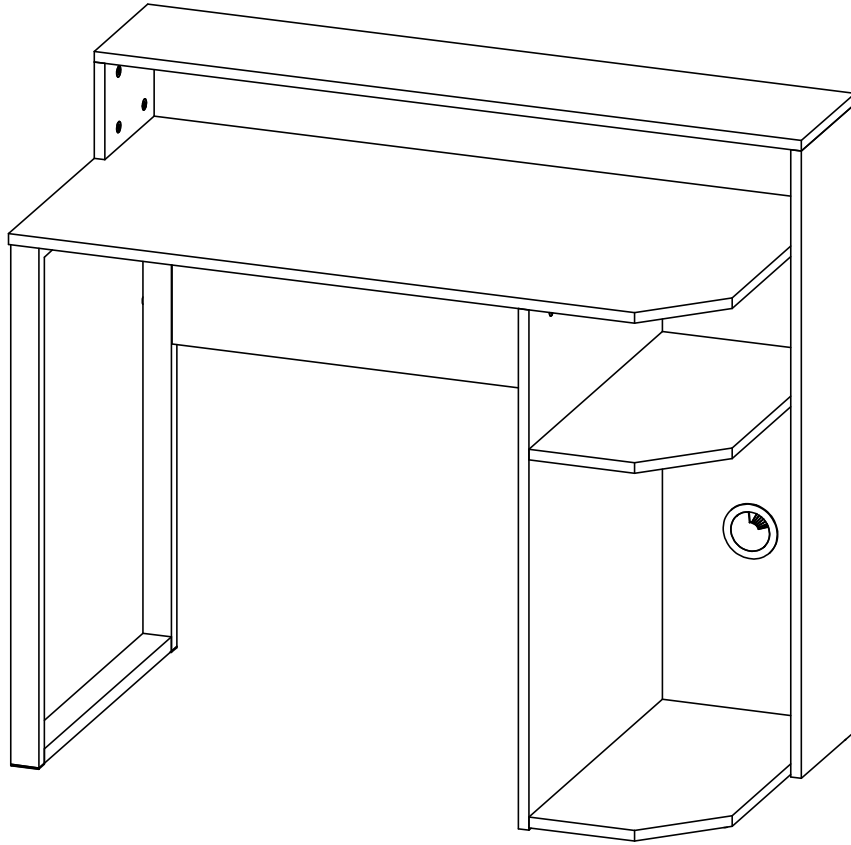

IMPORTANT

On a regular basis please check that the screws and fittings have not become loose as this could present a potential choke hazard.

Assembly is complete