

NOKIA

Nokia 3310

User Guide

About this user guide



Important: For important information on the safe use of your device and battery, read “For your safety” and “Product Safety” info in the printed user guide, or at www.nokia.com/support before you take the device into use. To find out how to get started with your new device, read the printed user guide.

Table of Contents

About this user guide	2
Get started	6
Keys and parts	6
Set up and switch on your phone	7
Charge your phone	11
Lock or unlock the keys	11
Basics	13
Get the most out of the two SIM cards	13
Explore your phone	13
Change the volume	17
Change your ring or message tone	18
Change the wallpaper	19
Write text	19
Calls, contacts, and messages	21
Calls	21
Contacts	21
Send and receive messages	22
Personalize your phone	24
Change your ring or message tone	24
Change the look of your home screen	24
Profiles	25
Settings for Go to	26
Camera	27
Photos	27
Videos	27
Internet and connections	29
Browse the web	29
Music and videos	30
Music player	30
Video player	30
Radio	32

Find and save radio stations	32
Listen to radio	32
Clock, calendar, and calculator	33
Set the time and date manually	33
Alarm clock	33
Calendar	33
Calculator	34
Bluetooth	35
Activate Bluetooth	35
Copy and remove content	36
Copy content	36
Share content	36
Remove private content from your phone	37
Backup and restore	38
Create a backup	38
Restore a backup	38
Settings	39
Call settings	39
Phone settings	39
Cost settings	39
Accessories	40
Security settings	40
Feedback	40
Restore factory settings	41
Message settings	41
Product and safety information	43
For your safety	43
Network services and costs	46
Emergency calls	46
Take care of your device	46
Recycle	47
Crossed-out wheelie bin symbol	48
Battery and charger information	48
Small children	49
Medical devices	50

Implanted medical devices	50
Hearing	50
Protect your device from harmful content	51
Vehicles	51
Potentially explosive environments	51
Certification information (SAR)	52
Copyrights and other notices	53
About Digital Rights Management	54
Frequently asked questions	56
How do I get help for my phone?	56
Where can I find the warranty terms for my phone?	56
How do I get my phone repaired or replaced?	56
What should I do if my phone is lost or stolen?	56
Where can I see the full range of Nokia phones?	56
Where can I buy a Nokia phone?	56
My phone won't turn on, what should I do?	57
My phone won't charge, what should I do?	57
Troubleshooting tips	57
Where can I get support for my Lumia smartphone?	58

Get started

Keys and parts

Explore the keys and parts of your new phone.

YOUR PHONE

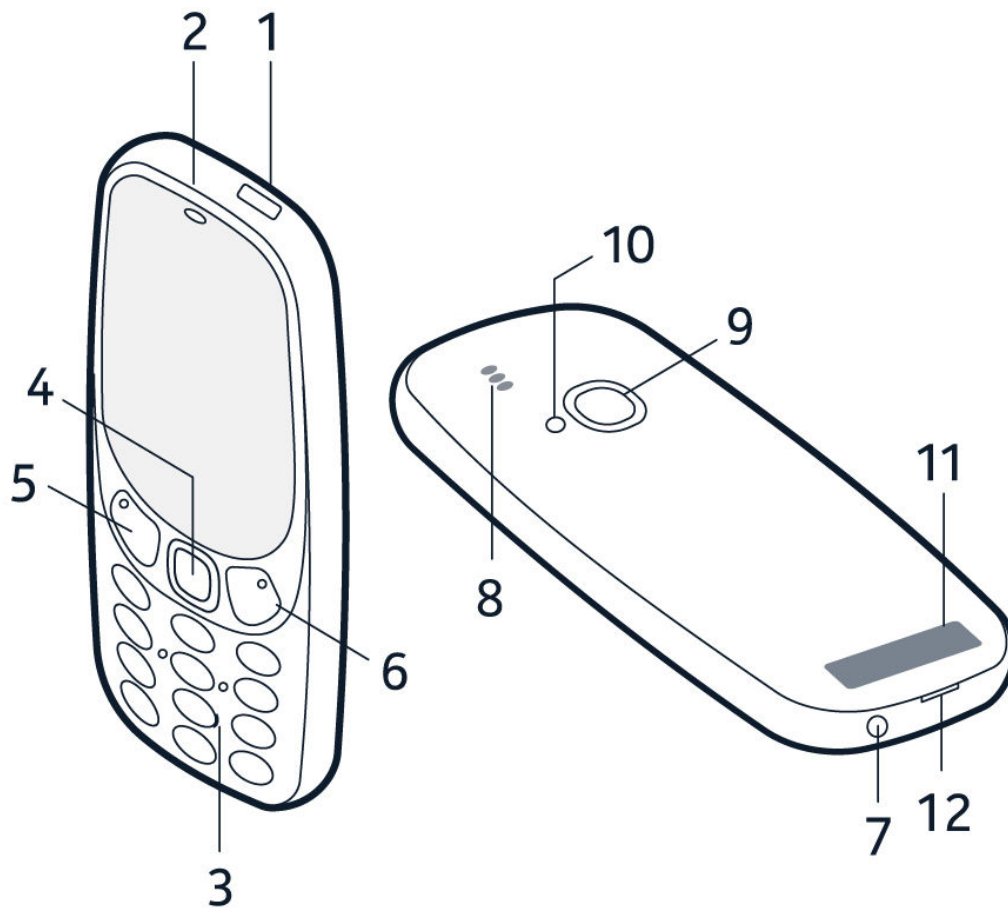

The keys and parts of your phone are:

- | | |
|----------------------|------------------------|
| 1. Charger connector | 7. Headphone connector |
| 2. Earpiece | 8. Loudspeaker |
| 3. Number keys | 9. Camera |
| 4. Selection key | 10. Flash light |

- | | |
|-------------------------------------|-----------------------------|
| 5. Function key, call key | 11. Antenna area |
| 6. Function key, end call/power key | 12. Back cover opening slot |

To lock the keys, select **Go to** > **Lock keypad**.

To unlock the keys, quickly press , and select **Unlock**.

Avoid touching the antenna area while the antenna is in use. Contact with antennas affects the communication quality and may reduce battery life due to higher power level during operation.

Do not connect to products that create an output signal, as this may damage the device. Do not connect any voltage source to the audio connector. If you connect an external device or headset, other than those approved for use with this device, to the audio connector, pay special attention to volume levels.

Parts of the device are magnetic. Metallic materials may be attracted to the device. Do not place credit cards or other magnetic storage media near the device, because info stored on them may be erased.

Some of the accessories mentioned in this user guide, such as charger, headset, or data cable, may be sold separately.



Note: You can set the phone to ask for a security code. The pre-set code is 12345. Change it to protect your privacy and personal data. Note, however, that when you change the code, you need to remember the new code, as HMD Global is not able to open or bypass it.

Set up and switch on your phone

Learn how to insert the SIM card, memory card, and battery, and how to switch on your phone.



MICRO SIM

Important: This device is designed to be used with a micro SIM card (see figure) only. Use of incompatible SIM cards may damage the card or the device, and may corrupt data stored on the card. Please consult your mobile operator for the use of a SIM card that has a nano-UICC cutout.



MICROSD MEMORY CARDS

Use only compatible memory cards approved for use with this device. Incompatible cards may damage the card and the device and corrupt data stored on the card.



Note: Switch the device off and disconnect the charger and any other device before removing any covers. Avoid touching electronic components while changing any covers. Always store and use the device with any covers attached.

SET UP YOUR PHONE (SINGLE SIM)

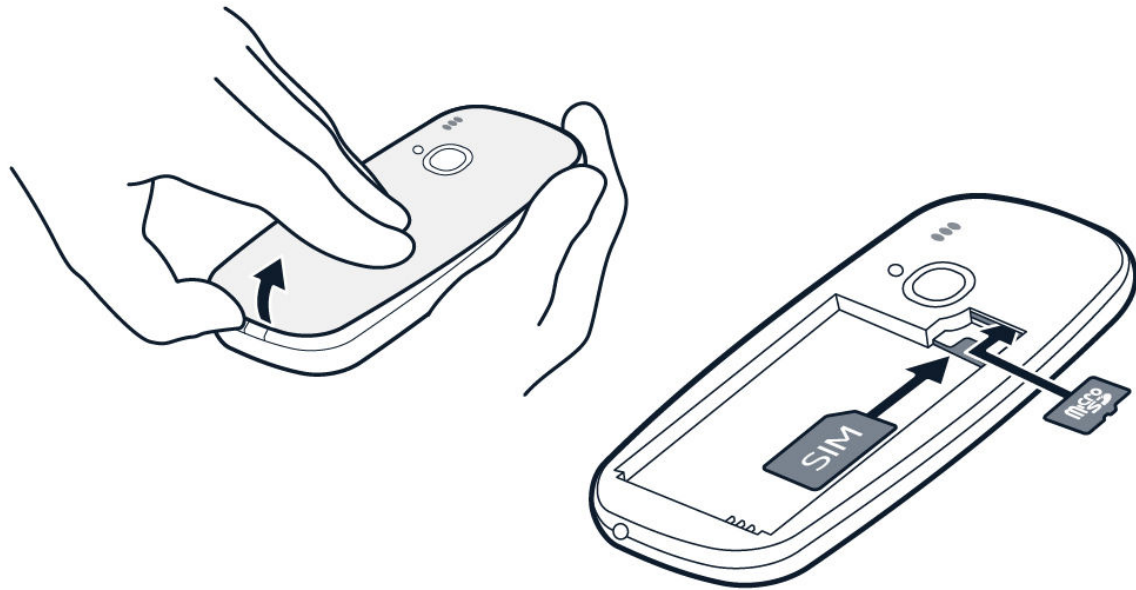

1. Place your fingernail in the small slot at the bottom of the phone, lift and remove the cover.
2. If the battery is in the phone, lift it out.
3. Slide the SIM into the SIM slot with the contact area face down.
4. If you have a memory card, slide the memory card into the memory card slot.
5. Line up the battery contacts, and put the battery in.
6. Replace the back cover.

SET UP YOUR PHONE (DUAL SIM)

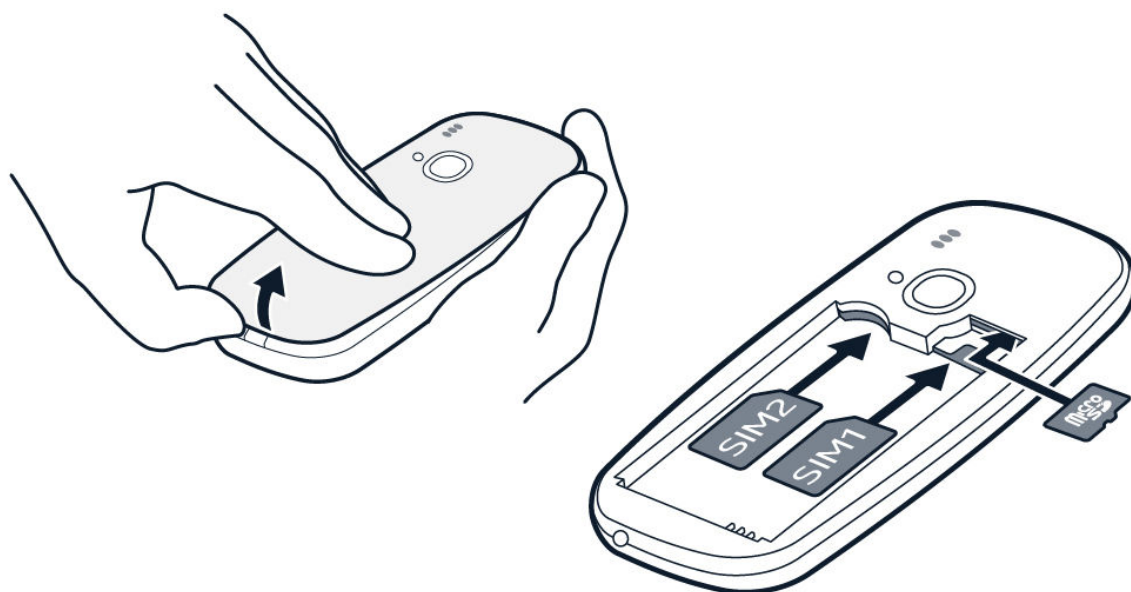

1. Place your fingernail in the small slot at the bottom of the phone, lift and remove the cover.
2. If the battery is in the phone, lift it out.
3. Slide the first SIM into SIM slot 1 with the contact area face down. Slide the second SIM into SIM slot 2. Both SIM cards are available at the same time when the device is not being used, but while one SIM card is active, for example, making a call, the other may be unavailable.
4. If you have a memory card, slide the memory card into the memory card slot.
5. Line up the battery contacts, and put the battery in.
6. Replace the back cover.

SWITCH ON YOUR PHONE

Press and hold the  key.

REMOVE THE SIM CARD

Open the back cover, remove the battery, and slide the SIM out.

REMOVE THE MEMORY CARD

Open the back cover, remove the battery, and pull the memory card out.

Charge your phone

Your battery has been partially charged at the factory, but you may need to recharge it before you can use your phone.

CHARGE THE BATTERY

1. Plug the charger into a wall outlet.
2. Connect the charger to the phone. When done, unplug the charger from the phone, then from the wall outlet.

If the battery is completely discharged, it may take several minutes before the charging indicator is displayed.



Tip: You can use USB charging when a wall outlet is not available. Data can be transferred while charging the device. The efficiency of USB charging power varies significantly, and it may take a long time for charging to start and the device to start functioning. Make sure your computer is switched on.

SAVE POWER

To save power:

1. Charge wisely: always charge the battery fully.
2. Select only the sounds that you need: mute unnecessary sounds, such as keypad sounds.
3. Use wired headphones, rather than the loudspeaker.
4. Change the phone screen settings: set the phone screen to switch off after a short time.
5. Lower the screen brightness.
6. When applicable, use network connections, such as Bluetooth, selectively: switch the connections on only when you are using them.

Lock or unlock the keys

LOCK THE KEYPAD

To avoid accidentally pressing the keys, use keypad lock. Select **Go to > Lock keypad**.

UNLOCK THE KEYPAD

Press , and select **Unlock**.

Basics

Get the most out of the two SIM cards

Your phone can use two SIM cards, and you can use them for different purposes.

SELECT WHICH SIM CARD TO USE

1. Select **Menu** >  > **Connectivity** > **Dual SIM**.
2. To choose which SIM to use for calls, select **Call**, switch **Always ask** to **Off**, and select **Preferred SIM**.
3. To choose which SIM to use for messages, select **Messaging**, switch **Always ask** to **Off**, and select **Preferred SIM**.
4. To choose which SIM to use for mobile data, switch **Mobile data connection** to **On**, and select **Mobile data** > **Preferred SIM**.

FORWARD CALLS BETWEEN YOUR 2 SIMS

Get the most out of your 2 SIM cards. If you forward your calls between your SIMs, when someone calls you on one SIM while you're having a call on the other, you can manage your calls from both SIMs just like with only one SIM.

Make sure you have 2 SIM cards inserted in your phone.

1. Select **Menu** >  > **SIM numbers**.
2. Type in the numbers of your both SIMs.
3. Depending on how you want to forward the calls when one of your SIMs is out of reach or busy, select **Between two SIMs**, **From SIM1 to SIM2**, or **From SIM2 to SIM1**.



Tip: To check if your calls are being forwarded, select **Check status**.

Explore your phone

SEE THE APPS AND FEATURES OF YOUR PHONE



Select **Menu** .

GO TO AN APP OR FEATURE

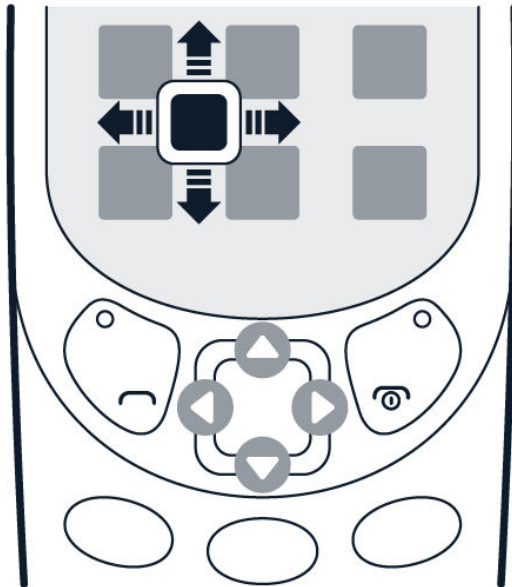

Press the scroll key up, down, left, or right.

OPEN AN APP OR SELECT A FEATURE



Select **Choose** .

GO BACK TO THE PREVIOUS VIEW

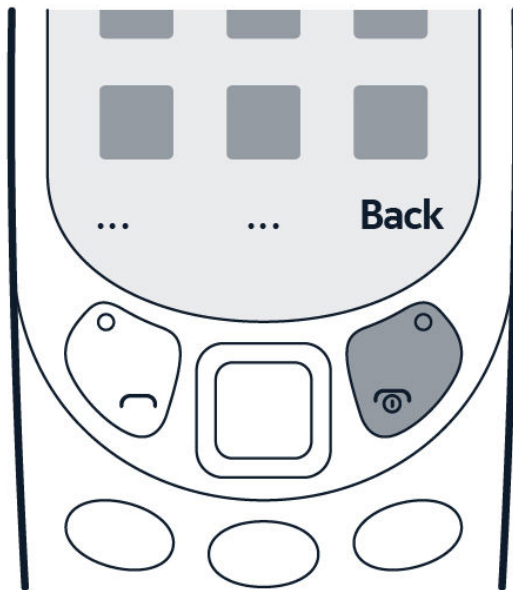

Select **Back**.

GO BACK TO THE HOME SCREEN

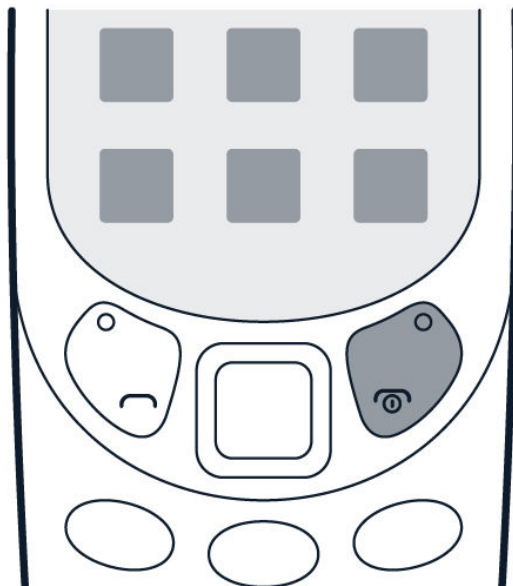

Press the end key.

SWITCH ON THE FLASHLIGHT



On the idle screen, quickly scroll up twice to switch on the flashlight.

To switch off the flashlight, scroll up once.

Do not shine the light in anyone's eyes.

Change the volume

TURN THE VOLUME UP OR DOWN

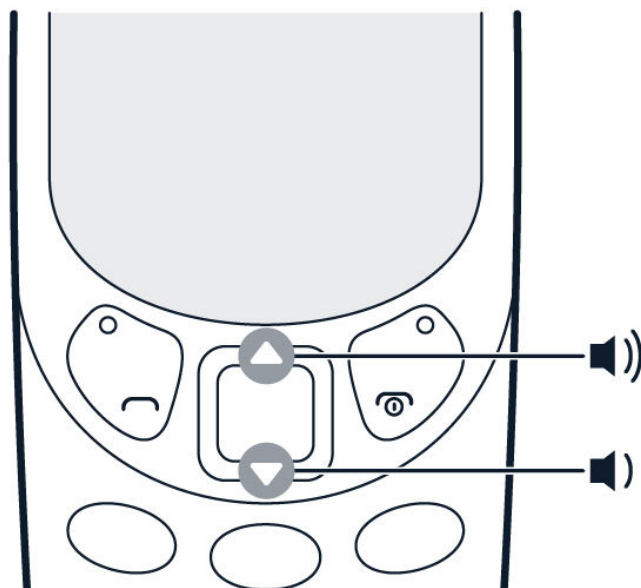

Trouble hearing your phone ringing in noisy environments, or calls too loud? You can change the volume to your liking.

Scroll up or down to change the volume during a call or when listening to the radio.

Change your ring or message tone

You can choose a new ringtone or message tone.

CHANGE YOUR RINGTONE

1. Select **Menu** > **⚙️** > **Tones** .
2. Choose **Ringtone** .
3. Scroll to a ringtone.
4. Press **OK** .



Tip: Is your ringtone too loud or too silent? Select **Ringtone volume** and scroll left or right.

CHANGE YOUR MESSAGE TONES

1. Select **Menu** > **⚙️** > **Tones** > **Messages**.
2. Scroll to a message tone.
3. Press **OK**.

Change the wallpaper

CHOOSE A NEW WALLPAPER

You can change the background of your home screen with **Wallpaper** setting.

1. Select **Menu** > **⚙️** > **Display settings** > **Wallpaper**.
2. Select **Default** to see the available wallpapers.
3. Scroll to a wallpaper and select **View** to see how it looks on the screen.
4. Select **Choose** and then the option to position the wallpaper on the screen.

You can also select a wallpaper from the photos you have on your phone.

Write text

WRITE USING THE KEYPAD

Writing with the keypad is easy and fun.

Press a key repeatedly until the letter is shown.

To type in a space press **0**.

To type in a special character or punctuation mark, press *****.

To switch between character cases, press **#** repeatedly.

To type in a number, press and hold a number key.

USE PREDICTIVE TEXT

To speed up your writing, your phone can guess what you are starting to write. Predictive text is based on a built-in dictionary. This feature is not available for all languages.

1. Select **Options** > **Predictive text** and the language.
2. Start writing a word. When the word you want is shown, press **0**.

To change a word, press ***** repeatedly until the word you want is shown.

If the word you want isn't in the dictionary, write the word, press ***** repeatedly to skip all unwanted words, select **Spell**, and write the word. The word is added to the dictionary.

To switch between predictive and traditional text, press **#** repeatedly.



To switch predictive text off, select **Options** > **Predictive text** > **Prediction off**.

Calls, contacts, and messages

Calls

MAKE A CALL

Learn how to make a call with your new phone.

1. Type in the phone number. To type in the + character, used for international calls, press * twice.
2. Press . If asked, select which SIM to use.
3. To end the call, press .

ANSWER A CALL

Press .



Tip: To handle your calls hands-free, pair your phone with a compatible Bluetooth headset (sold separately). To switch Bluetooth on, select **Menu** >  > **Connectivity** > **Bluetooth**, and switch **Bluetooth** to **On**.



Tip: If you are in a situation where you cannot answer the phone and you need to silence it quickly, select **Silence**.

Contacts

ADD A CONTACT

Save and organize your friends' phone numbers.

1. Select **Menu** >  > **Options** > **Add new contact** .
2. Write the name, and type in the number.
3. Select **Save** .



Tip:You can select which memory you want to use for storing contacts. Select **Options** >  > **Memory** .



Tip:To save a phone number in the dialer, type in the number, and select **Save** .

SAVE A CONTACT FROM CALL LOG

You can save contacts from call log.

1. Select **Menu** >  > **Received** or **Missed** , depending on from where you want to save the contact.
2. Highlight the number you want to save, and select **Options** > **Save** .
3. Add the contact's name and **Save** .

CALL A CONTACT OR SEND A MESSAGE

Call a contact directly from the contacts list. You can also send messages from the contacts list.

1. Select **Menu** >  and scroll to a contact you want to call or send a message.
2. Select the contact and select **Call** or **Send message** .

Send and receive messages

WRITE AND SEND MESSAGES

1. Select **Menu** >  > **Create message** .
2. Select **Add recipient** to add a recipient. You can enter a phone number or add a recipient from either **Contacts** or **Distribution lists** .
3. Write a message on the **Message** field.
4. Select **Send** .

WRITING OPTIONS

You can find different options for writing a message, in **Options** when you are in the message field. You can insert smileys and symbols, or use ready-made templates. You can add images or discard messages, and save them as drafts.

You can also turn on the dictionary from **Options**.

MESSAGE OPTIONS

When you have received messages in your phone, scroll to a message and select **Options**.

Select **Call** to call to the sender. You can delete conversations, and add the sender to a screened list. You can also access **Message settings**.

Personalize your phone

Change your ring or message tone

You can choose a new ringtone or message tone.

CHANGE YOUR RINGTONE

1. Select **Menu** > **⚙️** > **Tones**.
2. Choose **Ringtone**.
3. Scroll to a ringtone.
4. Press **OK**.



Tip: Is your ringtone too loud or too silent? Select **Ringtone volume** and scroll left or right.

CHANGE YOUR MESSAGE TONES

1. Select **Menu** > **⚙️** > **Tones** > **Messages**.
2. Scroll to a message tone.
3. Press **OK**.

Change the look of your home screen

Change the look of your home screen with display settings.

CHOOSE A NEW WALLPAPER

You can change the background of your home screen with **Wallpaper** setting.

1. Select **Menu** > **⚙️** > **Display settings** > **Wallpaper**.
2. Select **Default** to see the available wallpapers.

3. Scroll to a wallpaper and select **View** to see how it looks on the screen.
4. Select **Choose** and then the option to position the wallpaper on the screen.

You can also select a wallpaper from the photos you have on your phone.

CHANGE THE FONT SIZE

You can change the font size on your phone to larger in **Font size** setting.

1. Select **Menu** >  > **Display settings** > **Font size**.
2. Select the application where you want to have larger font, **Messaging**, **Contacts**, or **Menu**.
3. Scroll to the font size you want to use and select **Choose**.

SHOW DATE AND TIME

You can choose if you want to see date and time on the home screen of your phone.

1. Select **Menu** >  > **Date and time** > **Show date and time**.
2. Select **On** to have them visible on the home screen.

If you want your phone to have time updated automatically, set **Auto-update time** to **On**.

OTHER DISPLAY SETTINGS

You can edit other display settings too. You can set them on or off and change their features, such as time-out and intensity.

Profiles

Your phone has different profiles for different situations. You can edit the profiles to your liking.

PERSONALIZE PROFILES

There are several profiles that you can use in different situations. There is, for example, a silent profile for when you cannot have sounds on, and an outdoor profile with loud tones.

You can personalize profiles further.

1. Select **Menu** > **⚙️** > **Profiles**.
2. Select a profile and **Personalise**.

For each profile you can set a specific ringtone, ringtone volume, message sounds and so on.



Tip: You can add different profiles to **Go to** menu for quick access.

Settings for Go to

You can add quick links to different applications and settings to **Go to**.

EDIT GO TO SETTINGS

On the bottom left-hand corner you have **Go to**, and when you select it, you can access different applications and settings. You can change the applications and settings to your liking.

1. Select **Menu** > **⚙️** > **Go to settings**.
2. Select **Choose options**.
3. Scroll to a shortcut you want to add on the **Go to** list on the home screen and **Mark** them.
4. Select **Done** to exit the list, and **Yes** to save changes.

You can also reorganize your **Go to** list.

1. Select **Organise**.
2. Scroll to an item you want to move and select **Move**.
3. Select if you want to move it up, down, to top, or to bottom of the list.
4. Select **Back** to exit the list, and **Yes** to save changes.



Camera

Photos

You don't need a separate camera when your phone has all you need for capturing memories.

TAKE A PHOTO

Capture the best moments with your phone camera.

1. To switch the camera on, select **Menu** > .
2. To zoom in or out, scroll up or down.
3. To take a photo, select .



Tip: To take a selfie, select **Selfie** > .



Tip: To switch the flash on, in camera, select  > **Flash on**.

VIEW A PHOTO YOU HAVE TAKEN





To view the photo right after taking it, select **New** >  > **Photos** > **Captured**. To view the photo later, in camera, select  > **Photos** > **Captured**.

Videos

You don't need a separate video camera - record video memories with your phone.

RECORD A VIDEO

Besides taking photos, you can also record videos with your phone.

1. To switch the camera on select **Menu** > .
2. To switch the video camera on, select  > **Video camera** .
3. To start recording, select .
4. To stop recording, select .



Tip: Need more space for your videos? Insert a memory card, and your videos are saved directly to the card.

WATCH THE RECORDED VIDEO

To view the video right after recording, select .



Tip:To view the video later, select **Menu** >  > **Recorded** .

Internet and connections

Browse the web

Learn how to browse the web with your phone.

CONNECT TO INTERNET

Catch up on the news, and visit your favorite websites on the go.

1. Select **Menu** > **📶** > **Surf or search** .
2. Write a web address, and select **OK** .



Tip: If you want to avoid data costs, switch mobile data off when you are not surfing the web. In your single SIM phone, select **Menu** > **⚙️** > **Connectivity** > **Mobile data** , and switch **Mobile data connection** to **Off** .



Tip: If you want to avoid data costs, switch mobile data off when you are not surfing the web. In your dual SIM phone, select **Menu** > **⚙️** > **Connectivity** > **Dual SIM** , and switch **Mobile data connection** to **Off** .

Music and videos

Music player

You can listen to your MP3 music files with the music player. To play music, you need to store the music files on a memory card.

LISTEN TO MUSIC

1. Select **Menu** > .
2. Select **Options** > **All songs**.
3. Select a song.



Tip: To listen to music using wireless headphones, pair your phone with a compatible Bluetooth headset (sold separately). To switch Bluetooth on, select **Menu** >  > **Connectivity** > **Bluetooth**, and switch **Bluetooth** to **On**.

Video player

Watch your favorite videos wherever you are.

PLAY A VIDEO

1. Select **Menu** > .
2. Select the folder containing the video you want to watch, and then the video.



Tip: Not all video formats are supported.

PAUSE AND RESUME PLAYBACK

Press the scroll key, and select **Pause** or **Play**.

Radio

Find and save radio stations

Connect a compatible headset. It acts as an antenna.

SEARCH FOR YOUR FAVORITE RADIO STATIONS

1. Select **Menu** > .
2. To search for all available stations select **Options** > **Auto tuning**.
3. To switch to a saved station select **Options** > **Stations**, and scroll up or down.



Tip: To switch to a saved station, you can also press a number key.



Tip: To rename station, select the station and **Options** > **Rename**.

Listen to radio

Did you find a good radio station? Next, start listening to it!

LISTEN TO YOUR FAVORITE RADIO STATIONS ON YOUR PHONE

Select **Menu** > .

To change the volume, scroll up or down.

To close the radio, select **Options** > **Turn off**.

Clock, calendar, and calculator

Set the time and date manually

You can set your phone clock manually.

CHANGE THE TIME AND DATE

1. Select **Menu** >  > **Date and time**.
2. Switch **Auto-update time** to **Off**.
3. To set the time, scroll down, and select **Time**. Use the scroll key to set the time, and select **OK**.
4. To set the date, scroll down, and select **Date**. Use the scroll key to set the date, and select **OK**.

Alarm clock

Learn how to use the alarm clock to wake up and get to places on time.

SET AN ALARM

No clock around? Use your phone as an alarm clock.

1. Select **Menu** > .
2. Select an alarm and **Edit** > **Change**.
3. To set the hour, scroll up or down. To set the minutes, scroll right and then up or down.
4. Select **OK** > **Save**.

Calendar

Need to remember an event? Add it to your calendar.

ADD A CALENDAR REMINDER

1. Select **Menu** > **12**.
2. Select a date and **Options** > **Add event**.
3. Type in a name for the event.
4. To set the time, scroll down, and select **Change**. To set the hour, scroll up or down. To set the minutes, scroll right and then up or down.
5. Select **Save**.



Tip: By default, you are reminded by an alarm 15 minutes before the event. To change the alarm time, scroll down, and select **Change**. Select a reminder or **Never**.

Calculator

Learn how to add, subtract, multiply and divide with your phone calculator.

HOW TO CALCULATE

1. Select **Menu** > **%**.
2. Enter the first factor of your calculation, use the scroll key to select the operation, and enter the second factor.
3. Select **Equals** to get the result of the calculation.

Select **Clear** to empty the number fields.

Bluetooth

Activate Bluetooth

Connect your phone with Bluetooth to other devices.

SWITCH ON BLUETOOTH

Select **Menu** >  > **Connectivity** > **Bluetooth** and switch **Bluetooth** on.

Copy and remove content

Copy content

Copy photos, videos, music, and other content created by you (and stored on the memory card) between your phone and computer.

COPY CONTENT BETWEEN YOUR PHONE AND COMPUTER

To copy content from the phone memory, you need to have a memory card inserted in your phone.

1. Connect your phone to a compatible computer with a compatible USB cable.
2. Select **Mass storage**.
3. On your computer, open a file manager, such as Windows Explorer, and browse to your phone. You can see the content stored on the memory card.
4. Drag and drop items between your phone and computer.

Share content

Share your stuff, such as contacts, photos, and videos, easily with friends and family.

SHARE YOUR CONTENT USING SLAM

Just move your phone close to another phone and your content is transferred using Bluetooth.

1. Switch Bluetooth on in the receiving phone, and make sure the phone is visible to other phones.
2. Select, for example, a photo. Press the options key, and select **Share photo** > **Slam via Bluetooth**.
3. Move your phone close to the other phone.



Tip: Slam searches for the nearest phone, and sends the item to it.

Operating the device in hidden mode is a safer way to avoid malicious software. Do not accept Bluetooth connection requests from sources you do not trust. You can also switch the Bluetooth function off when you are not using it.

Remove private content from your phone

If you buy a new phone, or otherwise want to dispose of or recycle your phone, here's how you can remove your personal info and content.

REMOVE CONTENT FROM YOUR PHONE

When removing private content from your phone, pay attention to whether you are removing content from the phone memory or the SIM card.

1. To remove messages, select **Menu** > **Messages** > **Options** > **Delete more** > **Options** > **Choose all** > **Done**. Go to the folder you want to empty, and select **Options** > **Delete conversation** > **Yes**.
2. To remove contacts, select **Menu** > **Contacts** > **Options** > **Delete contacts** > **Options** > **Choose all** > **Done** > **Delete**.
3. To remove your call info, select **Menu** > **Call log** > **Clear call log** > **All calls**.
4. Check that all your personal content has been removed.

Backup and restore

Create a backup

Sometimes you need to create a backup of your phone data.

CREATE A BACKUP

1. Select **Menu** >  > **Backup** > **Create backup** .
2. Your device tells you that creating a backup may take a while and that you should not turn the phone off while the backup is created. Select **Choose** if you want to create a backup.
3. A list opens where you can mark the data you want to backup. You can **Mark** them one by one, or select **Options** > **Choose all** .
4. Your phone tells you when the backup is created.

Restore a backup

To restore a backup of your data you need the created backup file on a memory card.

RESTORE A BACKUP

1. Select **Menu** >  > **Backup** > **Restore backup** .
2. Select **Choose** and mark the data you want to restore, and select **Done** .
3. Your phone restarts after restoring the backup files.

Settings

Call settings

You can change the call settings of your phone.

AVAILABLE CALL SETTINGS

You can edit call settings depending on a setting. You can set them to be either on or off, and check the status of the setting.

You can add phone numbers to lists to be screened or blocked in call settings.

1. Select **Menu** >  > **Call settings** .
2. Select a setting you want to change.

Phone settings

You can change your phone settings.

AVAILABLE PHONE SETTINGS

You can edit phone settings depending on a setting. You can change the language of your phone, set keyguard to be on or off, and add a welcome note.

Cost settings

You can track your costs with cost settings.

AVAILABLE COST SETTINGS

You can set **Call trackers** to be **On** or **Off** .

Accessories

You can edit the accessory settings.

ACCESSORY SETTINGS

Select the available accessory and edit its settings.

Security settings

You can edit the available security settings.

AVAILABLE SECURITY SETTINGS

You can edit the security settings depending on a setting. You can set them to be either on or off, and check the status of the setting.

You can add phone numbers to a list to be blocked and create a closer user group.

1. Select **Menu** >  > **Security settings** > **Change codes** .
2. Select the code you want to change, either **Change security code** or **Change barr. password** .

Feedback

You can send feedback on your phone.

SEND FEEDBACK

You can send feedback on your phone directly from **Settings** .

1. Select **Menu** >  > **Feedback** .
2. Give feedback to questions as instructed, and select **Send** .

Restore factory settings

You can restore factory settings in this setting. Be careful, however, since you lose all personalization and all data you have added on the phone.

RESET YOUR PHONE

Accidents may happen and your phone may stop responding. You can restore the original factory settings, but be careful, since this reset removes all data you have saved in the phone memory and all your personalization.

If you are disposing your phone, note that you are responsible of removing all private content.

You need to have the security code to restore the original settings. To reset your phone to its original settings and to remove all your data, on the home screen, type in ***#7370#**.

1. Select **Menu** >  > **Rest. factory settings** .
2. Enter the security code. There is no more confirmation after you select **OK** , but the phone is reset and all data is removed.

Message settings

You can edit the message settings.

MESSAGE SETTINGS

Select **Menu** >  > **Options** > **Message settings** .

You can edit general message settings, and settings for text messages, MMS messages and operator messages separately.



Tip: You can change the text font larger in messages in Messaging application. Select **Options** > **Message settings** > **General settings** > **Larger font** .

Product and safety information

For your safety

Read these simple guidelines. Not following them may be dangerous or against local laws and regulations. For further info, read the complete user guide.



SWITCH OFF IN RESTRICTED AREAS

Switch the device off when mobile phone use is not allowed or when it may cause interference or danger, for example, in aircraft, in hospitals or near medical equipment, fuel, chemicals, or blasting areas. Obey all instructions in restricted areas.



ROAD SAFETY COMES FIRST

Obey all local laws. Always keep your hands free to operate the vehicle while driving. Your first consideration while driving should be road safety.



INTERFERENCE

All wireless devices may be susceptible to interference, which could affect performance.



QUALIFIED SERVICE

Only qualified personnel may install or repair this product.



BATTERIES, CHARGERS, AND OTHER ACCESSORIES

Use only batteries, chargers, and other accessories approved by HMD Global Oy for use with this device. Do not connect incompatible products.



KEEP YOUR DEVICE DRY

If your device is not water-resistant, keep it dry.



PROTECT YOUR HEARING

To prevent possible hearing damage, do not listen at high volume levels for long periods. Exercise caution when holding your device near your ear while the loudspeaker is in use.



SAR

This device meets RF exposure guidelines when used either in the normal use position against the ear or when positioned at least 0.2 inches (5 mm) away from the body. The specific maximum SAR values can be found in the Certification Information (SAR) section of this user guide. For more info, go to www.sar-tick.com.

When a carry case, belt clip or other form of device holder is used for body-worn operation, it should not contain metal and should provide at least the above-stated separation distance from the body. Note that mobile devices may be transmitting even if you are not making a voice call.

Network services and costs

Using some features and services, or downloading content, including free items, require a network connection. This may cause the transfer of large amounts of data, which may result in data costs. You may also need to subscribe to some features.

You can only use your device on the GSM 900/1800 networks. You need a subscription with a service provider.

Emergency calls



Important: Connections in all conditions cannot be guaranteed. Never rely solely on any wireless phone for essential communications like medical emergencies.

Before making the call:

- Switch the phone on.
- If the phone screen and keys are locked, unlock them.
- Move to a place with adequate signal strength.

1. Press the end key repeatedly, until the home screen is shown.
2. Type in the official emergency number for your present location. Emergency call numbers vary by location.
3. Press the call key.
4. Give the necessary info as accurately as possible. Do not end the call until given permission to do so.

You may also need to do the following:

- Put a SIM card in the phone.
- If your phone asks for a PIN code, type in the official emergency number for your present location, and press the call key.
- Switch the call restrictions off in your phone, such as call barring, fixed dialling, or closed user group.

Take care of your device

Handle your device, battery, charger and accessories with care. The following suggestions help you keep your device operational.

- Keep the device dry. Precipitation, humidity, and all types of liquids or moisture can contain minerals that corrode electronic circuits.
- Do not use or store the device in dusty or dirty areas.
- Do not store the device in high temperatures. High temperatures may damage the device or battery.
- Do not store the device in cold temperatures. When the device warms to its normal temperature, moisture can form inside the device and damage it.
- Do not open the device other than as instructed in the user guide.
- Unauthorized modifications may damage the device and violate regulations governing radio devices.
- Do not drop, knock, or shake the device or the battery. Rough handling can break it.
- Only use a soft, clean, dry cloth to clean the surface of the device.
- Do not paint the device. Paint can prevent proper operation.
- Keep the device away from magnets or magnetic fields.
- To keep your important data safe, store it in at least two separate places, such as your device, memory card, or computer, or write down important info.

During extended operation, the device may feel warm. In most cases, this is normal. To avoid getting too warm, the device may automatically slow down, close apps, switch off charging, and if necessary, switch itself off. If the device is not working properly, take it to the nearest authorised service facility.

Recycle



Always return your used electronic products, batteries, and packaging materials to dedicated collection points. This way you help prevent uncontrolled waste disposal and promote the recycling of materials. Electrical and electronic products contain a lot of valuable materials, including metals (such as copper, aluminum, steel, and magnesium) and precious metals (such as gold, silver, and palladium). All materials of the device can be recovered as materials and energy.

Crossed-out wheelie bin symbol



CROSSED-OUT WHEELIE BIN SYMBOL

The crossed-out wheelie bin symbol on your product, battery, literature, or packaging reminds you that all electrical and electronic products and batteries must be taken to separate collection at the end of their working life. Do not dispose of these products as unsorted municipal waste: take them for recycling. For info on your nearest recycling point, check with your local waste authority.

Battery and charger information

BATTERY AND CHARGER

Use your device only with an original BL-4UL rechargeable battery.

Charge your device with AC-18 charger. Charger plug type may vary.

HMD Global may make additional battery or charger models available for this device.

Battery type: BL-4UL

Single SIM

- Theoretical talk time up to 22.1 hours
- Theoretical standby time up to 31 days

Dual SIM

- Theoretical talk time up to 22.1 hours.
- Theoretical standby time up to 25.3 days

BATTERY AND CHARGER SAFETY INFO

To unplug a charger or an accessory, hold and pull the plug, not the cord.

When your charger is not in use, unplug it. If left unused, a fully charged battery will lose its charge over time.

Always keep the battery between 59°F and 77°F (15°C and 25°C) for optimal performance. Extreme temperatures reduce the capacity and lifetime of the battery. A device with a hot or cold battery may not work temporarily. Accidental short-circuiting can happen when a metallic object touches the metal strips on the battery. This may damage the battery or the other object.

Do not dispose of batteries in a fire as they may explode. Obey local regulations. Recycle when possible. Do not dispose as household waste.

Do not dismantle, cut, crush, bend, puncture, or otherwise damage the battery in any way. If a battery leaks, do not let liquid touch skin or eyes. If this happens, immediately flush the affected areas with water, or seek medical help. Do not modify, attempt to insert foreign objects into the battery, or immerse or expose it to water or other liquids. Batteries may explode if damaged.

Use the battery and charger for their intended purposes only. Improper use, or use of unapproved or incompatible batteries or chargers may present a risk of fire, explosion, or other hazard, and may invalidate any approval or warranty. If you believe the battery or charger is damaged, take it to a service centre or your phone dealer before continuing to use it. Never use a damaged battery or charger. Only use the charger indoors. Do not charge your device during a lightning storm.

Small children

Your device and its accessories are not toys. They may contain small parts. Keep them out of the reach of small children.

Medical devices

Operation of radio transmitting equipment, including wireless phones, may interfere with inadequately shielded medical devices' function. Consult a physician or the medical device's manufacturer to determine if it is adequately shielded from external radio energy.

Implanted medical devices

To avoid potential interference, manufacturers of implanted medical devices recommend a minimum separation of 15.3 centimeters (6 inches) between a wireless device and the medical device. Persons who have such devices should:

- Always keep the wireless device more than 15.3 centimeters (6 inches) from the medical device.
- Not carry the wireless device in a breast pocket.
- Hold the wireless device to the ear opposite the medical device.
- Switch the wireless device off if there is any reason to suspect that interference is taking place.
- Follow the manufacturer directions for the implanted medical device.

If you have any questions about using your wireless device with an implanted medical device, consult your health care provider.

Hearing



Warning: When you use the headset, your ability to hear outside sounds may be affected. Do not use the headset where it can endanger your safety.

Some wireless devices may interfere with some hearing aids.

Protect your device from harmful content

Your device may be exposed to viruses and other harmful content. Take the following precautions:

- Be cautious when opening messages. They may contain malicious software or otherwise be harmful to your device or computer.
- Be cautious when accepting connectivity requests, browsing the internet, or downloading content. Do not accept Bluetooth connections from sources you do not trust.
- Only install and use services and software from sources that you trust and that offer adequate security and protection.
- Install antivirus and other security software on your device and any connected computer. Only use one antivirus app at a time. Using more may affect performance and operation of the device and/or computer.
- If you access preinstalled bookmarks and links to third party internet sites, take the appropriate precautions. HMD Global does not endorse or assume liability for such sites.

Vehicles

Radio signals may affect improperly installed or inadequately shielded electronic systems in vehicles. For more info, check with the manufacturer of your vehicle or its equipment.

Only qualified personnel should install the device in a vehicle. Faulty installation may be dangerous and invalidate your warranty. Check regularly that all wireless device equipment in your vehicle is mounted and operating properly. Do not store or carry flammable or explosive materials in the same compartment as the device, its parts, or accessories. Do not place your device or accessories in the air bag deployment area.

Potentially explosive environments

Switch your device off in potentially explosive environments, such as near gasoline pumps. Sparks may cause an explosion or fire resulting in injury or death. Note restrictions in areas with fuel; chemical plants; or where blasting operations are in progress. Areas with a potentially explosive environment may not be clearly marked. These usually are areas where you are advised to switch your engine off, below deck on boats, chemical transfer or storage facilities, and where the air contains chemicals or particles. Check with the manufacturers of vehicles using liquefied petroleum gas (such as propane or butane) if this device can be safely used in their vicinity.

Certification information (SAR)

This mobile device meets guidelines for exposure to radio waves.

Your mobile device is a radio transmitter and receiver. It is designed not to exceed the limits for exposure to radio waves (radio frequency electromagnetic fields), recommended by international guidelines from the independent scientific organization ICNIRP. These guidelines incorporate substantial safety margins that are intended to assure the protection of all persons regardless of age and health. The exposure guidelines are based on the Specific Absorption Rate (SAR), which is an expression of the amount of radio frequency (RF) power deposited in the head or body when the device is transmitting. The ICNIRP SAR limit for mobile devices is 2.0 W/kg averaged over 10 grams of tissue.

SAR tests are carried out with the device in standard operating positions, transmitting at its highest certified power level, in all its frequency bands.

This device meets RF exposure guidelines when used against the head or when positioned at least 5/8 inch (1.5 centimetres) away from the body. When a carry case, belt clip or other form of device holder is used for body-worn operation, it should not contain metal and should provide at least the above stated separation distance from the body.

To send data or messages, a good connection to the network is needed. Sending may be delayed until such a connection is available. Follow the separation distance instructions until the sending is finished.

During general use, the SAR values are usually well below the values stated above. This is because, for purposes of system efficiency and to minimise interference on the network, the operating power of your mobile is automatically decreased when full power is not needed for the call. The lower the power output, the lower the SAR value.

Device models may have different versions and more than one value. Component and design changes may occur over time and some changes could affect SAR values.

For more info, go to www.sar-tick.com. Note that mobile devices may be transmitting even if you are not making a voice call.

The World Health Organization (WHO) has stated that current scientific information does not indicate the need for any special precautions when using mobile devices. If you are interested in reducing your exposure, they recommend you limit your usage or use a hands-free kit to keep the device away from your head and body. For more information and explanations and discussions on RF exposure, go to the WHO website at www.who.int/peh-emf/en.

Copyrights and other notices

DECLARATION OF CONFORMITY

Hereby, HMD Global Oy (Ltd.) declares that this product is in compliance with the essential requirements and other relevant provisions of Directive 2014/53/EC. A copy of the Declaration of Conformity can be found at www.nokia.com/mobile-declaration-of-conformity.

The availability of products, features, apps and services may vary by region. For more info, contact your dealer or your service provider.

This device may contain commodities, technology or software subject to export laws and regulations from the US and other countries. Diversion contrary to law is prohibited.

The contents of this document are provided "as is". Except as required by applicable law, no warranties of any kind, either express or implied, including, but not limited to, the implied warranties of merchantability and fitness for a particular purpose, are made in relation to the accuracy, reliability or contents of this document. HMD

Global reserves the right to revise this document or withdraw it at any time without prior notice.

To the maximum extent permitted by applicable law, under no circumstances shall HMD Global or any of its licensors be responsible for any loss of data or income or any special, incidental, consequential or indirect damages howsoever caused.

Reproduction, transfer or distribution of part or all of the contents in this document in any form without the prior written permission of HMD Global is prohibited. HMD Global operates a policy of continuous development. HMD Global reserves the right to make changes and improvements to any of the products described in this document without prior notice.

HMD Global does not make any representations, provide a warranty, or take any responsibility for the functionality, content, or end-user support of third-party apps provided with your device. By using an app, you acknowledge that the app is provided as is.

Downloading of maps, games, music and videos and uploading of images and videos may involve transferring large amounts of data. Your service provider may charge for the data transmission. The availability of particular products, services and features may vary by region. Please check with your local dealer for further details and availability of language options.

Certain features, functionality and product specifications may be network dependent and subject to additional terms, conditions, and charges. All are subject to change without notice.

Manufacturer and/or importer in EU: HMD Global Oy, Karaportti 2, 02610 Espoo, Finland.

HMD Global Privacy Policy, available at www.nokia.com/en{underscore}, applies to your use of the device.

© 2017 HMD Global. All rights reserved. HMD Global Oy is the exclusive licensee of the Nokia brand for phones & tablets. Nokia is a registered trademark of Nokia Corporation.

The Bluetooth word mark and logos are owned by the Bluetooth SIG, Inc. and any use of such marks by HMD Global is under license.

This product includes open source software. For applicable copyright and other notices, permissions, and acknowledgements, select *#6774# on the home screen.

About Digital Rights Management

When using this device, obey all laws and respect local customs, privacy and legitimate rights of others, including copyrights. Copyright protection may prevent you from copying, modifying, or transferring photos, music, and other content.

Frequently asked questions

How do I get help for my phone?

Have a look at our user guides first. If you still can't find what you're looking for, get in touch with your network provider or the store where you bought your phone.

Where can I find the warranty terms for my phone?

Have a look at the user guide that came with your phone, or you can get in touch with your network provider or the store you bought your phone from.

How do I get my phone repaired or replaced?

We offer replacement phones rather than repairs. In case your phone is defective, your network provider or the store you bought your phone from will be able to help getting you a replacement device.

What should I do if my phone is lost or stolen?

Contact your network provider right away and tell them it's missing. If your phone is stolen, you should also report it to the police immediately.

Where can I see the full range of Nokia phones?

Head [here](#) to see our latest mobile phones. Most mobile phone operators and retailers will also have all or some of the Nokia range available.

Where can I buy a Nokia phone?

You can buy a Nokia phone from most mobile phone operators and retailers.

My phone won't turn on, what should I do?

Charge your device for at least 10-30 minutes and then try turning it on. If that doesn't work you should contact your network provider or the store you bought it from.

My phone won't charge, what should I do?

First, make sure the socket you're using is providing power by plugging another device in. Next check the power cable for any damage. Do the same with your phone's charging port and remove any debris that might be stuck in it. Once you've checked everything's OK, turn your phone off and plug it in – if the battery is completely drained it may take 2-3 minutes to start charging. If that doesn't work, get in touch with your network provider or the store you bought it from.

Troubleshooting tips

If you're having problems with your phone, it's always worth trying one of the following to see if it helps:

Restart your phone

Turn your phone off and take the battery out. Wait a 30 seconds put the battery back in and then switch your phone on.

Charge your phone

Once the battery is full, disconnect the charger and try restarting your phone.

If the battery is completely discharged, it may take several minutes before the charging indicator is shown or before you can make any calls. If the battery has not been used for a long time, you may need to connect and disconnect the charger a couple of times.

Restore the factory settings

If your phone isn't working properly you can try resetting it. This does not affect documents or files stored on your phone but **we recommend you back it up first before restoring to factory settings, just in case.**( > Backup).

1. End all calls and connections
2. Go to Menu >  > Restore Factory Settings > Settings only
3. Type in your passcode

After restoring the original settings, your phone switches off and then on again. This may take longer than usual.

Where can I get support for my Lumia smartphone?

There are two main resources that provide support for Lumia phones. For general support and information, you can visit [Microsoft Mobile devices help page](#). For troubleshooting and repair queries, you can visit [B2X](#) and search for your Lumia model.