



Refrigerator

User manual (fridge only)

RR39*

Free Standing Appliance

SAMSUNG



Contents

Safety information	3
Important safety symbols and precautions:	6
Severe warning signs for transportation and site	7
Critical installation warnings	7
Installation cautions	11
Critical usage warnings	12
Usage warning	16
Usage cautions	17
Cleaning cautions	19
Critical disposal warnings	20
Additional tips for proper usage	22
Saving Energy Tips	23
This appliance is intended to be used in household and similar applications such as	23
Instructions about the WEEE	24
Installation	25
Refrigerator at a glance	25
Step-by-step installation	26
Operations	30
Feature panel	30
Special features	33
Maintenance	35
Door reversal (applicable models only)	35
Handle and care	51
Cleaning	52
Replacement	52
Side-by-side installation	53
Troubleshooting	56
General	56
Do you hear abnormal sounds from the refrigerator?	58
Appendix	60
Safety Instruction	60
Install Instruction	60
Temperature Instruction	61
Information for model and ordering spare parts	64



Safety information

- Before using your new Samsung Refrigerator, please read this manual thoroughly to ensure that you know how to operate the features and functions that your new appliance offers safely and efficiently.
- This appliance is not intended for use by persons (including children) with reduced physical, sensory, or mental capabilities, or those who lack experience and knowledge, unless they have been given supervision or instruction concerning the use of the appliance by a person responsible for their safety.
- This appliance can be used by children aged from 8 years and above and persons with reduced physical, sensory or mental capabilities or lack of experience and knowledge if they have been given supervision or instruction concerning use of the appliance in a safe way and understand the hazards involved. Children shall not play with the appliance. Cleaning and user maintenance shall not be made by children without supervision. Children aged from 3 to 8 years are allowed to load and unload refrigerating appliances.
- Warnings and Important Safety Instructions in this manual do not cover all possible conditions and situations that may occur.
It is your responsibility to use common sense, caution, and care when installing, maintaining, and operating your appliance.

Safety information

- Because these following operating instructions cover various models, the characteristics of your refrigerator may differ slightly from those described in this manual and not all warning signs may be applicable. If you have any questions or concerns, contact your nearest service center or find help and information online at www.samsung.com.
- In order to avoid the creation of a flammable gas-air mixture if a leak in the refrigerating circuit occurs, the size of the room in which the appliance may be sited depends on the amount of refrigerant used.
- Never start up an appliance showing any signs of damage. If in doubt, consult your dealer. The room must be 1 m³ in size for every 8 g of R-600a refrigerant inside the appliance. The amount of refrigerant in your particular appliance is shown on the identification plate inside the appliance.
- Refrigerant squirting out of the pipes could ignite or cause an eye injury. When refrigerant leaks from the pipe, avoid any naked flames and move anything flammable away from the product and ventilate the room immediately.
 - Failing to do so may result in fire or explosion.
- It is hazardous for anyone other than an Authorised Service Person to service this appliance.
- Do not store explosive substances such as aerosol cans with a flammable propellant in this appliance.
- To avoid contamination of food, please respect the following instructions:
 - Opening the door for long periods can cause a significant increase of the temperature in the compartments of the appliance.

- Clean regularly surfaces that can come in contact with food and accessible drainage systems.
- Clean water tanks if they have not been used for 48 h; flush the water system connected to a water supply if water has not been drawn for 5 days.
- Store raw meat and fish in suitable containers in the refrigerator, so that it is not in contact with or drip onto other food.
- Two-star frozen-food compartments are suitable for storing pre-frozen food, storing or making icecream and making ice cubes.
- One-, two- and three-star compartments are not suitable for the freezing of fresh food.
- If the refrigerating appliance is left empty for long periods, switch off, defrost, clean, dry, and leave the door open to prevent mould developing within the appliance.



Warning; Risk of fire / flammable materials



Safety information

Important safety symbols and precautions:

Please follow all safety instructions in this manual. This manual uses the following safety symbols.

WARNING

Hazards or unsafe practices that may result in **severe personal injury, property damage, and/or death.**

CAUTION

Hazards or unsafe practices that may result in **severe personal injury and/or property damage.**

NOTE

Useful information that helps users understand or benefit from the refrigerator.

These warning signs are here to prevent injury to you and others.

Please follow them carefully.

After reading this section, keep it in a safe place for future reference.



Severe warning signs for transportation and site

WARNING

- When transporting and installing the appliance, care should be taken to ensure that no parts of the refrigerating circuit are damaged.
 - Refrigerant leaking from the pipe work could ignite or cause an eye injury. If a leak is detected, avoid any naked flames or potential sources of ignition and air the room in which the appliance is standing for several minutes.
 - This appliance contains a small amount of isobutane refrigerant (R-600a), a natural gas with high environmental compatibility that is, however, also combustible. When transporting and installing the appliance, care should be taken to ensure that no parts of the refrigerating circuit are damaged.

Critical installation warnings

WARNING

- Do not install the refrigerator in a damp location or place where it may come in contact with water.
 - Deteriorated insulation on electrical parts may cause an electric shock or fire.
- Do not place this refrigerator in direct sunlight or expose it to the heat from stoves, room heaters, or other appliances.

Safety information

- Do not plug several appliances into the same multiple power strip. The refrigerator should always be plugged into its own individual electrical outlet which has a voltage rating that matches the voltage listed on the refrigerator's rating plate.
 - This provides the best performance and also prevents overloading of house wiring circuits, which could cause a fire hazard from overheated wires.
- If the wall socket is loose, do not insert the power plug.
 - There is a risk of electric shock or fire.
- Do not use a power cord that has cracks or abrasion damage along its length or at either end.
- Do not bend the power cord excessively or place heavy objects on it.
- Do not pull or excessively bend the power cord.
- Do not twist or tie the power cord.
- Do not hook the power cord over a metal object, place a heavy object on the power cord, insert the power cord between objects, or push the power cord into the space behind the appliance.
- When moving the refrigerator, be careful not to roll over or damage the power cord.
 - This may result in an electric shock or fire.
- Never unplug your refrigerator by pulling on the power cord. Always grip the plug firmly and pull straight out from the outlet.
 - Damage to the cord may cause a short-circuit, fire, and/or electric shock.
- Do not store explosive substances such as aerosol cans with a flammable propellant in this appliance.

-
- Do not install this appliance near a heater or inflammable material.
 - Do not install this appliance in a location where gas may leak.
 - This may result in an electric shock or fire.
 - This refrigerator must be properly located and installed in accordance with the instructions in this manual before you use it.
 - Connect the power plug in the proper position with the cord hanging down.
 - If you connect the power plug upside down, the wire can get cut off and cause a fire or electric shock.
 - Make sure that the power plug is not crushed or damaged by the back of the refrigerator.
 - Keep the packing materials out of reach of children.
 - There is a risk of death from suffocation if a child puts the packing materials on his or her head.
 - The appliance must be positioned so that the plug is accessible after installation.
 - Failing to do so may result in an electric shock or fire due to electric leakage.
 - Do not install this appliance in a humid, oily or dusty location, in a location exposed to direct sunlight and water (rain drops).
 - Deteriorated insulation of electrical parts may cause an electric shock or fire.
 - If any dust or water is in the refrigerator, pull out power plug and contact your Samsung Electronics service center.
 - Otherwise there is a risk of fire.

Safety information

- Do not stand on top of the appliance or place objects (such as laundry, lighted candles, lighted cigarettes, dishes, chemicals, metal objects, etc.) on the appliance.
 - This may result in an electric shock, fire, problems with the product, or injury.
- You need to remove all the protective plastic film before you initially plug the product in.
- Children should be supervised to ensure that they do not play with the snap rings used for door adjustment or the water tube clips.
 - There is risk of death by suffocation if a child swallows a snap ring or water tube clip. Keep the snap rings and water tube clips out of children's reach.
- The refrigerator must be safely grounded.
 - Always make sure that you have grounded the refrigerator before attempting to investigate or repair any part of the appliance. Power leakages can cause severe electric shock.
- Never use gas pipes, telephone lines, or other potential lightning attractors as an electrical ground.
 - You must ground the refrigerator to prevent any power leakages or electric shocks caused by current leakage from the refrigerator.
 - This may result in an electric shock, fire, explosion, or problems with the product.
- Plug the power plug into the wall socket firmly. Do not use a damaged power plug, damaged power cord, or loose wall socket.
 - This may result in an electric shock or fire.

- If the power cord is damaged, have it replaced immediately by the manufacturer or one of its service agents.
- The fuse on the refrigerator must be changed by a qualified technician or service company.
 - Failing to do so may result in an electric shock or personal injury.
- When positioning the appliance, ensure the supply cord is not trapped or damaged.
- Do not locate multiple portable socket-outlets or portable power supplies at the rear of the appliance.

Installation cautions

CAUTION

- Allow sufficient space around the refrigerator and install it on a flat surface.
 - Keep the ventilation space in the appliance enclosure or mounting structure clear of obstructions.
- Allow the appliance to stand for 2 hours before loading foods after installation and turning on.
- We strongly recommend you have a qualified technician or service company install the refrigerator.
 - Failing to do so may result in an electric shock, fire, explosion, problems with the product, or injury.
- Overload on any one door may fell the refrigerator, causing physical injury.

Safety information

Critical usage warnings

WARNING

- Do not insert the power plug into a wall socket with wet hands.
 - This may result in an electric shock.
- Do not store articles on the top of the appliance.
 - When you open or close the door, the articles may fall and cause personal injury and/or material damage.
- Do not insert hands, feet or metal objects (such as chopsticks, etc.) into the bottom or the back of the refrigerator.
 - This may result in an electric shock or injury.
 - Any sharp edges may cause a personal injury.
- Do not put a container filled with water on the refrigerator.
 - If spilled, there is a risk of fire or electric shock.
- Do not keep volatile or flammable objects or substances (benzene, thinner, propane gas, alcohol, ether, LP gas, and other such products) in the refrigerator.
 - This refrigerator is for storing food only.
 - This may result in fire or explosion.
- Children should be supervised to ensure that they do not play with the appliance.
 - Keep fingers out of “pinch point” areas. Clearances between the doors and cabinet are necessarily small. Be careful when you open the doors if children are in the area.
- Do not let children hang on the door or door bins. A serious injury may occur.

-
- Do not let children go inside the refrigerator. They could become trapped.
 - Do not insert your hands into the bottom area under the appliance.
 - Any sharp edges may cause personal injury.
 - Do not store pharmaceutical products, scientific materials, or temperature sensitive products in the refrigerator.
 - Products that require strict temperature controls must not be stored in the refrigerator.
 - Do not place or use electrical appliance inside the refrigerator, unless they are of a type recommended by the manufacturer.
 - If you smell pharmaceutical or smoke, pull out power plug immediately and contact your Samsung Electronics service center.
 - If any dust or water is in Refrigerator, pull out power plug and contact your Samsung Electronics service center.
 - Otherwise there is a risk of fire.
 - Do not let children step on a drawer.
 - The drawer may break and cause them to slip.
 - Do not leave the doors of the refrigerator open while the refrigerator is unattended and do not let children enter inside the refrigerator.
 - Do not allow babies or children go inside the drawer.
 - It can cause death from suffocation by entrapment or personal injury.
 - Do not overfill the refrigerator with food.
 - When you open the door, an item may fall out and cause personal injury or material damage.

Safety information

- Do not spray volatile material such as insecticide onto the surface of the appliance.
 - As well as being harmful to humans, it may also result in an electric shock, fire, or problems with the product.
- Do not use or place any substances sensitive to temperature such as flammable sprays, flammable objects, dry ice, medicine, or chemicals near or inside of the refrigerator.
- Do not use a hair dryer to dry the inside of the refrigerator. Do not place a lighted candle in the refrigerator for removing bad odours.
 - This may result in an electric shock or fire.
- Do not stand on top of the appliance or place objects (such as laundry, lighted candles, lighted cigarettes, dishes, chemicals, metal objects, etc.) on the appliance. This may result in an electric shock, fire, problems with the product, or injury. Do not put a container filled with water on the appliance.
 - If spilled, there is a risk of fire or electric shock.
- Do not use mechanical devices or any other means to accelerate the defrosting process, other than those recommended by the manufacturer.
- Do not damage the refrigerant circuit.
- Never stare directly at the UV LED lamp for long periods of time.
 - This may result in eye strain due to the ultraviolet rays.
- Do not put fridge shelf in upside down. Shelf stopper could not work.
 - It may cause a personal injury because of glass shelf drop.

-
- Keep fingers out of “pinch point” areas. Clearances between the doors and cabinet are necessarily small. Be careful when you open the doors if children are in the area.
 - If a gas leak is detected, avoid any naked flames or potential sources of ignition, and air the room in which the appliance is standing for several minutes.
 - Do not touch the appliance or power cord.
 - Do not use a ventilating fan.
 - A spark may result in explosion or fire.
 - Use only the LED Lamps provided by the manufacturer or its service agents.
 - Bottles should be stored tightly together so that they do not fall out.
 - This product is intended only for the storage of food in a domestic environment.
 - Do not attempt to repair, disassemble, or modify the refrigerator yourself.
 - Unauthorized modifications can cause safety problems. To reverse an unauthorized modification, we will charge the full cost of parts and labor.
 - Do not use any fuse (such as cooper, steel wire, etc.) other than a standard fuse.
 - If your refrigerator needs to be repaired or reinstalled, contact your nearest service center.
 - Failing to do so may result in an electric shock, fire, problems with the product, or injury.
 - If the interior or exterior LED lamp has gone out, contact your nearest service center.

Safety information

- If the refrigerator emits a burning smell or smoke, unplug the refrigerator immediately and contact your Samsung Electronics service center.
 - Failing to do so may result in an electric or fire hazards.
- Pull the power plug out of the socket before changing the interior lamps of the refrigerator.
 - Otherwise, there is a risk of electric shock.
- If you experience difficulty changing a non-LED light, contact a Samsung service center.
- If the product is equipped with LED lamps, do not disassemble the Lamp Covers and LED lamps yourself.
 - Contact a Samsung service center.
- Plug the power plug into the wall socket firmly.
- Do not use a damaged power plug, damaged power cord or loose wall socket.
 - This may result in an electric shock or fire.

Usage warning

WARNING

- Keep ventilation openings, in the appliance enclosure or in the built-in structure, clear of obstruction.
- Do not use mechanical devices or other means to accelerate the defrosting process, other than those recommended by the manufacturer.
- Do not damage the refrigerant circuit.
- Do not use electrical appliances inside the food storage compartments of the appliance, unless they are of the type recommended by the manufacturer.

Usage cautions

CAUTION

- To get the best performance from the product:
 - Do not place food too close to the vents at the rear of the refrigerator as this can obstruct free air circulation in the refrigerator compartment.
 - Wrap food up properly or place it in airtight containers before putting it into the refrigerator.
 - Please observe maximum storage times and expiration dates of frozen goods.
- Service Warranty and Modification.
 - Any changes or modifications performed by a 3rd party on this finished appliance are not covered under Samsung warranty service, nor is Samsung responsible for safety issues that result from 3rd party modifications.
- Do not block the air vents inside the refrigerator.
 - If the air vents are blocked, especially with a plastic bag, the refrigerator can be over cooled.
- Wipe excess moisture from the inside and leave the doors open.
 - Otherwise, odor and mold may develop.
- If the refrigerator is disconnected from the power supply, you should wait for at least five minutes before plugging it back in.
- When the refrigerator got wet by water, pull out the power plug and contact your Samsung Electronics service center.

Safety information

- Do not strike or apply excessive force to any glass surface.
 - Broken glass may result in a personal injury and/or property damage.
- Fill the water tank and ice cube trays with potable water only (tap water, mineral water, or purified water).
 - Do not fill the tank with tea or a sports drink. This may damage the refrigerator.
- Be careful that your fingers are not caught in.
- If the refrigerator is flooded, make sure to contact your nearest service center.
 - There is a risk of electric shock or fire.

Cleaning cautions

CAUTION

- Do not spray water directly on the inside or outside the refrigerator.
 - There is a risk of fire or electric shock.
- Do not use a hair dryer to dry the inside of the refrigerator.
- Do not place a lighted candle in the refrigerator to remove bad odors.
 - This may result in an electric shock or fire.
- Fill the water tank, ice tray and water cubes only with potable water (mineral water or purified water).
 - Do not fill the tank with tea, juice or sports drink, this may damage the refrigerator.
- Do not spray cleaning products directly on the display.
 - Printed letters on the display may come off.
- If any foreign substance such as water has entered the appliance, unplug the power plug and contact your nearest service center.
 - Failing to do so may result in an electric shock or fire.
- Use a clean, dry cloth to remove any foreign matter or dust from the power plug blades. Do not use a wet or damp cloth when cleaning the plug.
 - Otherwise, there is a risk of fire or electric shock.
- Do not clean the appliance by spraying water directly onto it.

Safety information

- Do not use benzene, thinner, or Clorox, Chloride for cleaning.
 - They may damage the surface of the appliance and may cause a fire.
- Never put fingers or other objects into the dispenser hole.
 - It may cause a personal injury or material damage.
- Before cleaning or performing maintenance, unplug the appliance from the wall socket.
 - Failing to do so may result in an electric shock or fire.

Critical disposal warnings

WARNING

- Please dispose of the packaging material from this product in an environmentally friendly manner.
- Ensure that none of the pipes on the back of the refrigerator are damaged prior to disposal.
- R-600a or R-134a is used as a refrigerant. Check the compressor label on the rear of the appliance or the rating label inside the fridge to see which refrigerant is used for your refrigerator. If this refrigerator contains flammable gas (Refrigerant R-600a), contact your local authority in regard to safe disposal of this product.

-
- When disposing of this refrigerator, remove the door/door seals and door latch so that small children or animals cannot become trapped inside. Children should be supervised to ensure that they do not play with the appliance. If trapped inside, a child may get hurt or suffocate to death.
 - If trapped inside, the child may become injured and suffocate to death.
 - Cyclopentane is used in the insulation. The gases in the insulation material require a special disposal procedure. Please contact your local authorities in regard to the environmentally safe disposal of this product.
 - Keep all packaging materials well out of the reach of children, as packaging materials can be dangerous to children.
 - If a child places a bag over his or her head, the child could suffocate.

Safety information

Additional tips for proper usage

- In the event of a power failure, call the local office of your electric company and ask how long the failure is going to last.
 - Most power failures that are corrected in an hour or two will not affect your refrigerator temperatures. However, you should minimize the number of door openings while the power is off.
 - Should the power failure last more than 24 hours, remove and discard all stored food.
- The refrigerator might not operate consistently if sited for an extended period of time in a location where ambient air temperatures are constantly below the temperatures for which the appliance is designed.
- In case of particular foods, keeping it under refrigeration can have a bad effect on preservation due to its properties.
- Your appliance is frost free, which means there is no need to manually defrost your appliance. This will be carried out automatically.
- Temperature rise during defrosting complies with ISO requirements. If you want to prevent an undue rise in the temperature of stored food while the appliance defrosts, wrap the stored food in several layers of newspaper.

Saving Energy Tips

- Install the appliance in a cool, dry room with adequate ventilation. Ensure that it is not exposed to direct sunlight and never put it near a direct source of heat (a radiator, for example).
- Not to block any vents and grilles is recommended for energy efficiency.
- Allow warm food to cool down before placing it in the appliance.
- Do not keep the door of the refrigerator open for too long when putting food in or taking food out.
- It is recommended to install the refrigerator with clearance to the back and sides. This will help reduce power consumption and keep your energy bills lower.
- For the most efficient use of energy, please keep the all inner fittings such as baskets, drawers, shelves on the position supplied by manufacturer.

This appliance is intended to be used in household and similar applications such as

- staff kitchen areas in shops, offices and other working environments;
- farm houses and by clients in hotels, motels and other residential type environments;
- bed and breakfast type environments;
- catering and similar non-retail applications.

Safety information

Instructions about the WEEE



Correct Disposal of This Product (Waste Electrical & Electronic Equipment) (Applicable in countries with separate collection systems)

This marking on the product, accessories or literature indicates that the product and its electronic accessories (e.g. charger, headset, USB cable) should not be disposed of with other household waste at the end of their working life. To prevent possible harm to the environment or human health from uncontrolled waste disposal, please separate these items from other types of waste and recycle them responsibly to promote the sustainable reuse of material resources.

Household users should contact either the retailer where they purchased this product, or their local government office, for details of where and how they can take these items for environmentally safe recycling.

Business users should contact their supplier and check the terms and conditions of the purchase contract. This product and its electronic accessories should not be mixed with other commercial wastes for disposal.

For information on Samsung's environmental commitments and product regulatory obligations, e.g. REACH, WEEE or Batteries, visit our sustainability page available via www.samsung.com

(For products sold in European countries and in the UK only)

Installation

Follow these instructions carefully to ensure a proper installation of this refrigerator and to prevent accidents before using it.

⚠ WARNING

- Use the refrigerator only for its intended purpose as described in this manual.
- Any servicing must be performed by a qualified technician.
- Dispose of the product packaging material in compliance with the local regulations.
- To prevent electric shock, unplug the power cord before servicing or replacements.

Refrigerator at a glance

The actual image and provided component parts of the refrigerator may differ, depending on the model and the country.

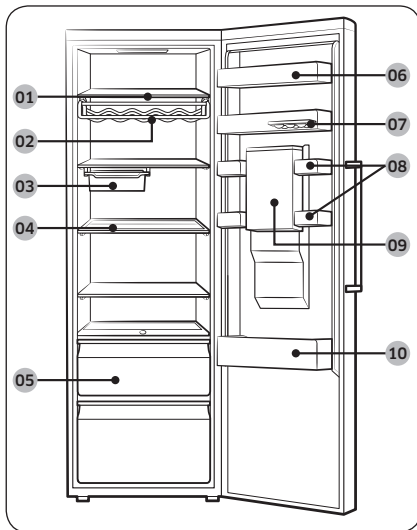

- 01 Fridge Shelves
 - 02 Wine rack *
 - 03 Moving Tray *
 - 04 Foldable shelf *
 - 05 Vegetable drawers
 - 06 Dairy guard
 - 07 Removable egg tray
 - 08 Multipurpose bin
 - 09 Water Tank *
 - 10 Beverage guard
- * applicable models only

📖 NOTE

- For best energy efficiency, make sure all of shelves, drawers, and baskets are placed in their original position.
- Keep soft food such as cheese in the multipurpose bin. For bottled beverages, store them in the beverage guard.

Installation

Step-by-step installation

STEP 1 Select a site

Site requirements:

- Solid, level surface without carpeting or flooring that may obstruct ventilation
- Away from direct sunlight
- Adequate room for opening and closing the door
- Away from a heat source
- Room for maintenance and servicing
- Temperature range: between 10 °C and 43 °C

Clearance

See the pictures and table below for space requirements for installation.

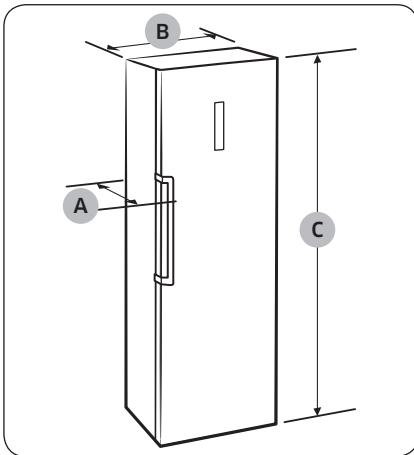

Depth "A"	694
Width "B"	595
Overall Height "C"	1853

(unit : mm)

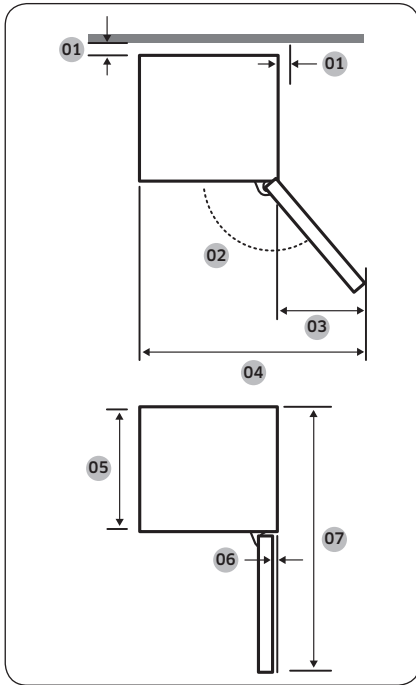

01	more than 50 mm recommended
02	130°
03	377
04	967
05	575
06	5.5
07	1194

(unit : mm)

NOTE

The measurements in the above table may differ, depending on the measuring method.

STEP 2 Flooring

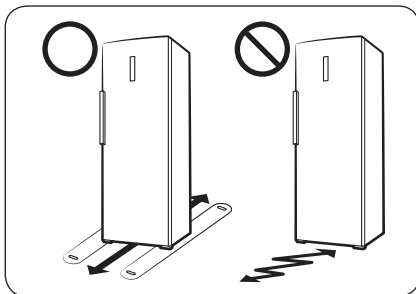

- The surface to install the refrigerator must support a fully loaded refrigerator.
- To protect the floor, put a large piece of cardboard on each foot of the refrigerator.
- Once the refrigerator is in its final position, do not move it unless necessary to protect the floor. If you have to, use a thick paper or cloth such as old carpet along the movement path.

Installation

STEP 3 Adjust the levelling legs

⚠ CAUTION

- The refrigerator must be levelled on a flat, solid floor. Failing to do so can cause damage to the refrigerator or physical injury.
- Levelling must be performed with an empty refrigerator. Make sure no food items remain inside the refrigerator.
- For safety reasons, adjust the front side a little higher than the rear side.

The refrigerator can be levelled using the front legs that have a special screw (leveller) for levelling purposes. Use a flat-head screwdriver for levelling.

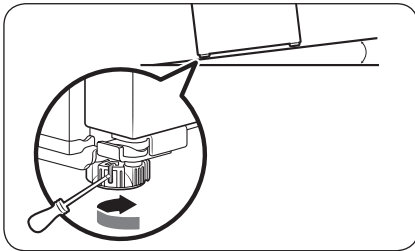

To adjust the height of the left side:

Insert a flat-head screwdriver into the leveller of the front left leg. Turn the leveller clockwise to raise, or turn it counter clockwise to lower.

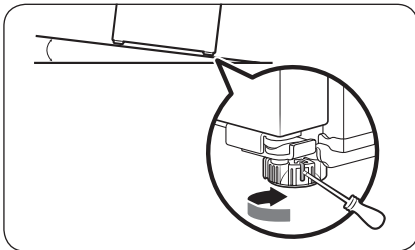

To adjust the height of the right side:

Insert a flat-head screwdriver into the leveller of the front right leg. Turn the leveller clockwise to raise, or turn it counter clockwise to lower.



STEP 4 Initial settings

By completing the following steps, the refrigerator should be fully functioning.

1. Remove the PE foam sheet on each shelf corner, which is attached to protect the refrigerator during transportation.
2. Plug the power cord into the wall socket to turn the refrigerator on .
3. Open the door, and check if the interior light lights up.
4. Set the temperature to the coldest available, and wait for about an hour. Then, the refrigerator will be slightly chilled with the motor running smoothly.
5. Wait until the refrigerator reaches the set temperature. Now the refrigerator is ready for use.

NOTE

When the refrigerator powers on, the alarm will sound. To turn off the alarm, press **Fridge**.

STEP 5 Final check

When installation is complete, confirm that:

- The refrigerator is plugged into an electrical outlet and grounded properly.
- The refrigerator is installed on a flat, level surface with a reasonable clearance from the wall or the cabinet.
- The refrigerator is level and is sitting firmly on the floor.
- The door opens and closes freely, and the interior light turns on automatically when you open the door.



Operations

Feature panel

TYPE A

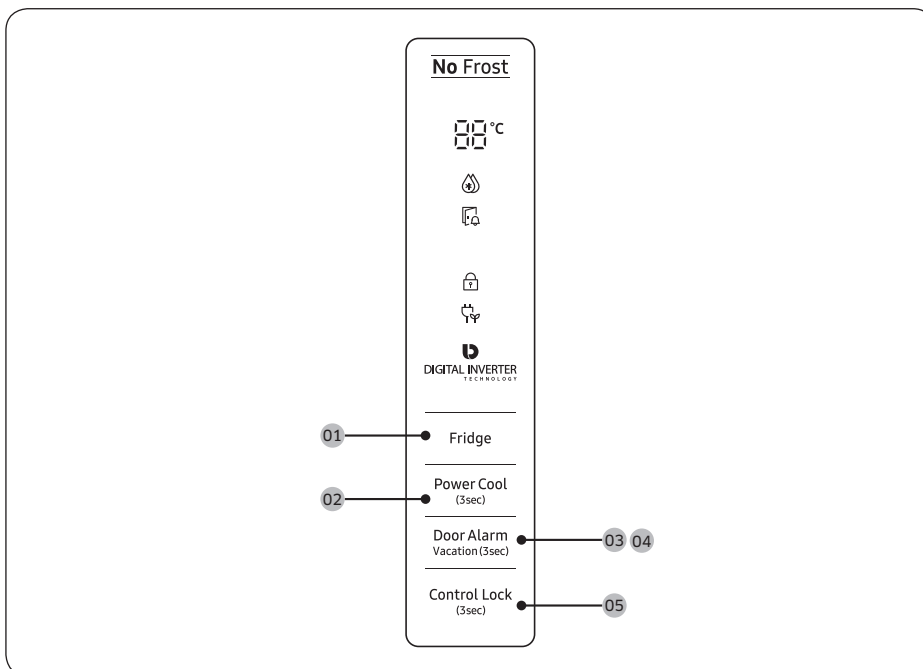

TYPE B

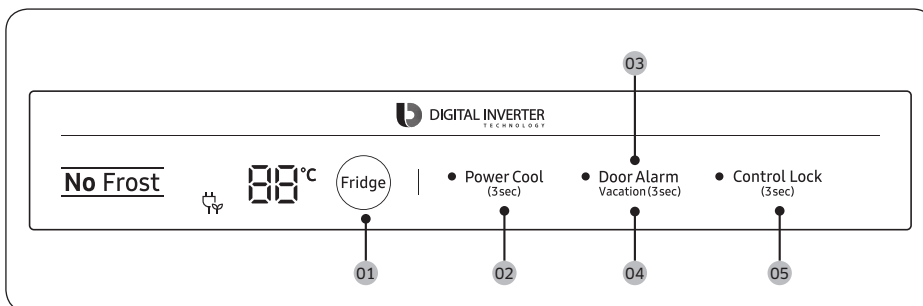



01 Fridge

02 Power Cool

03 Door Alarm

04 Vacation

05 Control Lock

01 Fridge

Fridge	To adjust the fridge temperature, press Fridge to select the corresponding temperature. You can change the temperature between 1 °C and 7 °C (default: 3 °C).
--------	---

02 Power Cool (3 sec)

Power Cool	<p>Power Cool speeds up the cooling process at maximum fan speed. The fridge keeps running at full speed for two and a half hours and then returns to the previous temperature.</p> <ul style="list-style-type: none"> To activate Power Cool, press and hold Power Cool for 3 seconds. The corresponding indicator (🔥) lights up, and the refrigerator will speed up the cooling process for you. To deactivate Power Cool, press and hold Power Cool again for 3 seconds. The fridge returns to the previous temperature setting. <p>NOTE Using Power Cool increases power consumption. Make sure you turn it off and return to the previous temperature if you don't intend to use it.</p>
------------	--

03 Door Alarm

Door Alarm	<p>You can set the alarm for a reminder. If the door is left open for more than 2 minutes, the alarm will sound with the Alarm indicator blinking.</p> <p>You can toggle to enable and disable the alarm by pressing Door Alarm.</p>
------------	---



Operations

04 Vacation (3 sec)

Vacation	<p>If you are going on vacation or a business trip, or if you do not intend to use the fridge for an extended time, use the Vacation mode.</p> <ul style="list-style-type: none">• To activate Vacation mode, press and hold Vacation for 3 seconds. The Vacation On indicator turns on while the display of the fridge temperatures will turn off. The fridge temperature will be controlled under 17 °C.• To deactivate Vacation mode, press and hold Vacation again for 3 seconds. The fridge temperature will return to the previous setting. <p> NOTE</p> <ul style="list-style-type: none">• Make sure to remove foods in the fridge compartment before using Vacation mode.• The Vacation mode will be disabled if you adjust the temperature.
----------	---

05 Control Lock (3 sec)

Control Lock	<p>To prevent accidents or unintended use of the controls, press and hold Control Lock for 3 seconds to activate the Control Lock. All controls will be disabled with the indicator  on.</p> <p>To deactivate, press and hold again for 3 seconds. The controls will be enabled as normal.</p>
--------------	--

Special features

The actual image and special functions of your refrigerator may differ, depending on the model and the country.

Water dispenser (applicable models only)

With the water dispenser, you can dispense water without opening the fridge door. The water tank must be filled with potable water before use.

To fill the water tank with potable water

Open the door and locate the water tank that is surrounded by the door bins.

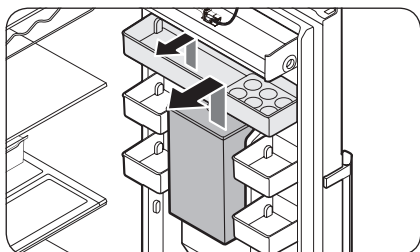

1. Hold the handgrips on both sides of the water tank and lift up to remove.

NOTE

Remove the **upper guard** first before removing the **water tank**.

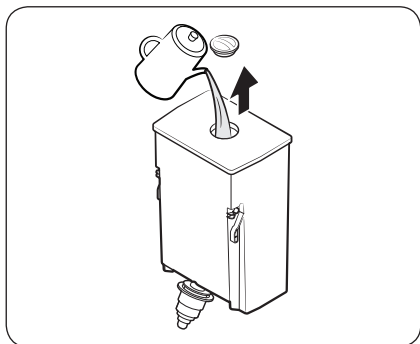

2. Fill the **water tank** with potable water up to 4.5 liters. You can remove either the top cap or the cover and pour water.

NOTE

For first-time use, clean inside the **water tank**.

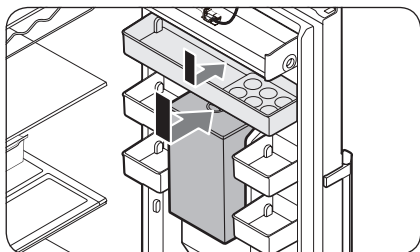

3. Reinsert the **water tank** first then the **upper guard**. Put the **water tank** on the door wall and lower vertically to fit into position. Do not slant the water tank.

Operations

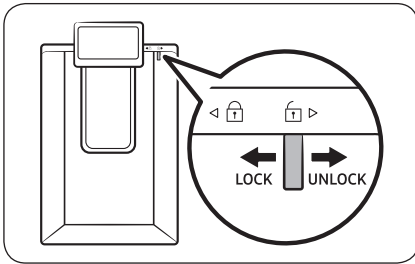

4. Put a water glass under the water outlet of the dispenser, and gently push the dispenser lever to dispense water. Make sure the water dispenser is unlocked.

CAUTION

- The water dispenser is designed to dispense potable water. Fill the water tank only with potable water. Do not fill with any other liquids.
- Do not fill the water tank excessively, which causes an overflow.
- Make sure that water tank is seated properly.
- Do not use the refrigerator without the water tank. This may reduce performance and efficiency.
- To prevent water bouncing, make sure the glass is in line with the dispenser lever.

Maintenance

Door reversal (applicable models only)

Reversing the door must be performed by Samsung-approved servicing personnel at your own expense because this kind of servicing is not covered by the Warranty.

⚠ WARNING

- Reversing failure or property damage that may occur by unapproved agencies will not be covered by the Warranty.
- Make sure that the refrigerator is disconnected from the power source before doing the reversal.
- You must wait for at least an hour after door reversing is complete. This is to prevent electric shock that could occur.

Tools required (not provided)

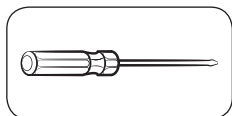

Phillips screwdriver

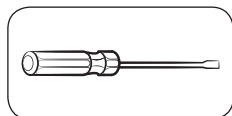

Flat-head screwdriver



10 mm spanner
(for top hinge shaft)

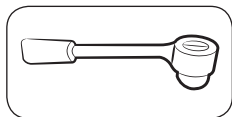

8 mm socket wrench
(for bolts)



12 mm spanner
(for bottom hinge shaft)

Accessories

The appearance of the accessories listed below may differ with the model.

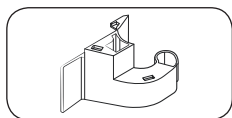

Hinge cover (L)

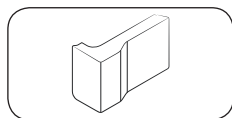

Space cover (L)

⚠ CAUTION

Throughout the entire reversing procedure, keep all the small parts (screws, caps, etc.) of the refrigerator away from children or infants for safety reasons.

Maintenance

Step-by-step instructions

STEP 1 Remove the handle

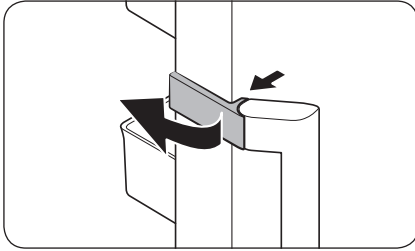

1. Unlock the **handle cap** and put it aside.

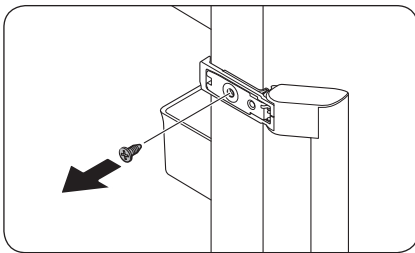

2. Remove each screw on the upper and lower side of the handle.

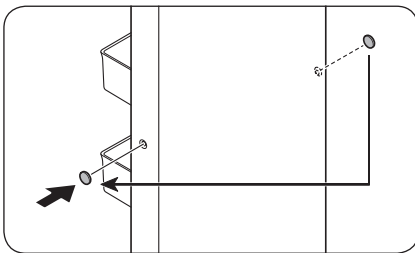

3. Use a flat-head screwdriver to remove the **handle screw caps** (x2). Then, insert the **handle screw caps** in the opposite side.

⚠ CAUTION

To prevent physical damage, use caution when removing the **handle screw caps**.

📖 NOTE

Keep the handle safe for later use.

STEP 2 Remove the fridge door

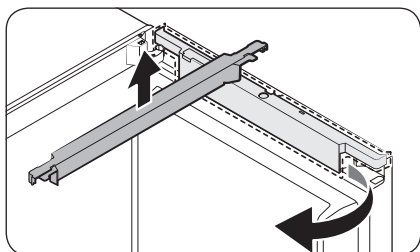
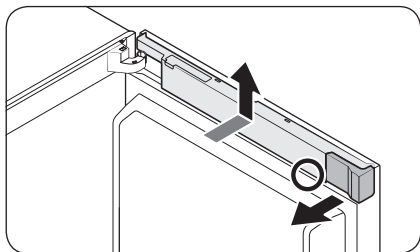

1. Remove the **space cover**.
2. While holding down the lower areas (marked in the figure) of the **wire cover** with both hands, lift up the **wire cover**.

3. Turn the **wire cover** to the front by 90 degrees, and then push up to remove.

 **NOTE**

Keep both the **space cover** and the **wire cover** in a safe place. They are necessary when you return the door to the initial position (before reversing the door).

Maintenance

Display Type A

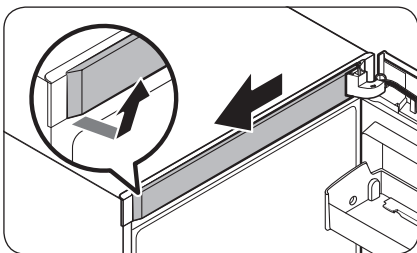

1. Remove the **top frame cover** from the right side first. Then, pull out to the front.

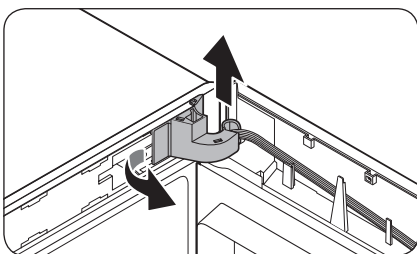

2. Pull out the left side of the **hinge cover** to remove, and then slightly lift up the bottom to pull out.

⚠ CAUTION

When removing the **hinge cover**, use caution not to damage the connectors and wires on or around the fridge door.

📖 NOTE

Keep the **hinge cover** in a safe place. It is necessary when you return the door to the initial position (before reversing the door).

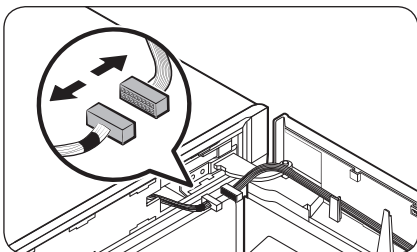

3. Disconnect the connectors on or around the fridge door. Loosen the screws from the **top hinge** to remove.

⚠ CAUTION

To prevent the fridge door from falling, make sure to hold the fridge door tight while removing the **top hinge**.

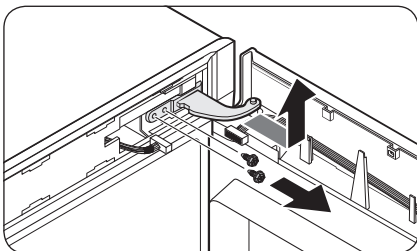

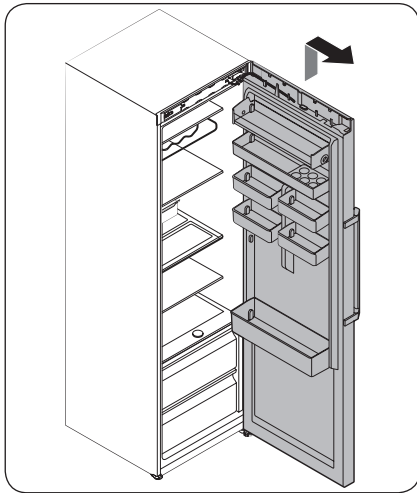

- When the **top hinge** is removed, lift up to remove the fridge door. Keep the door in a safe place.

⚠ CAUTION

The door is heavy. To prevent damage or injury, use caution while removing the door.

Display Type B

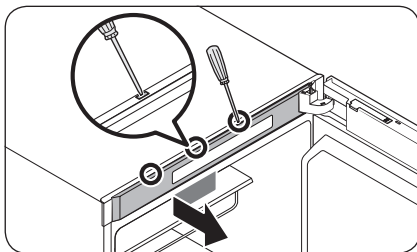

- Use a flat-head screwdriver to insert in the holes one after another on the top of the door to remove the **top frame cover**.

📖 NOTE

Start with the hole farthest from the hinge.

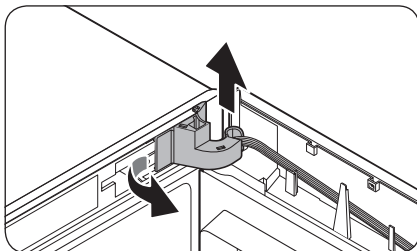

- Pull out the left side of the **hinge cover** to remove, and then slightly lift up the bottom to pull out.

⚠ CAUTION

When removing the **hinge cover**, use caution not to damage the connectors and wires on or around the fridge door.

📖 NOTE

Keep the **hinge cover** in a safe place. It is necessary when you return the door to the initial position (before reversing the door).

Maintenance

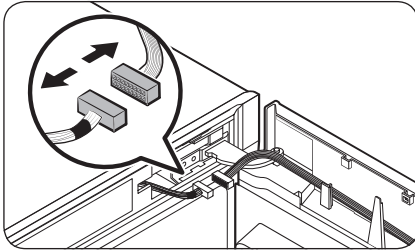

3. Disconnect the connectors on or around the fridge door. Loosen the screws from the **top hinge** to remove.

⚠ CAUTION

To prevent the fridge door from falling, make sure to hold the fridge door tight while removing the top hinge.

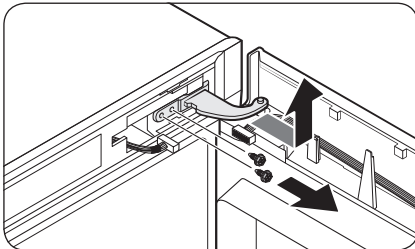

4. When the **top hinge** is removed, lift up to remove the fridge door. Keep the door in a safe place.

⚠ CAUTION

The door is heavy. To prevent damage or injury, use caution while removing the door.

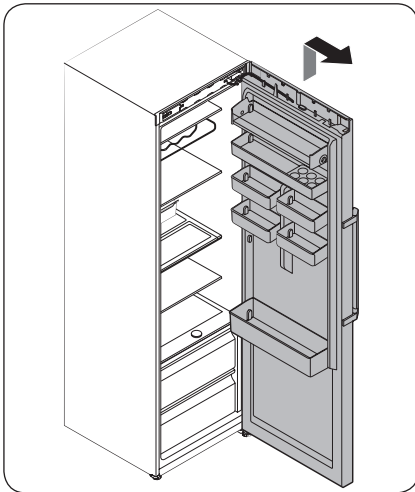

STEP 3 Reverse the auto closer

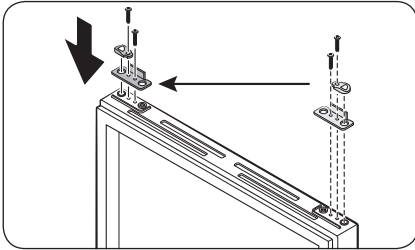

1. From the fridge door, remove the **auto closer lever** by loosening the screws on the lever and the screws in the opposite side.
2. Insert the **auto closer lever** in the opposite side, and tighten the screws.

Maintenance

STEP 4 Reverse the bottom hinge

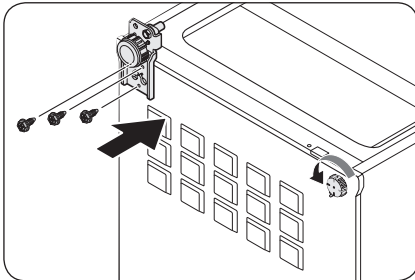
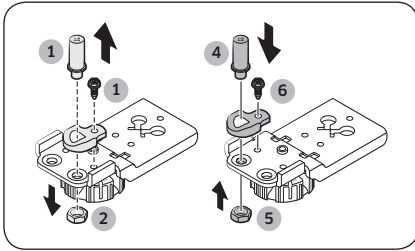
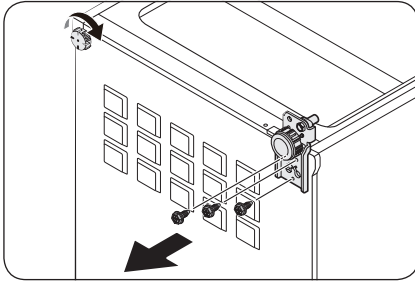

1. Lay down the refrigerator with care. Then, remove the screws from the **bottom hinge** on the right side and the **levelling leg** on the left side, respectively.

2. Use an 8 mm socket wrench to remove the **rear bolt** next to the **shaft**.

3. Remove the **shaft bolt** beneath the **bottom hinge**.

4. Use a Phillips screwdriver to remove the **shaft**.

5. Insert the **shaft** in the opposite side.

6. Reinsert and tighten the **rear bolt**.

7. Reinsert and tighten the **shaft bolt**.

8. Insert the **bottom hinge** in the opposite side and tighten with screws. Mount the **levelling leg** in the opposite side and tighten with screws.

9. Stand the refrigerator with care.

STEP 5 Reattach the fridge door

Display Type A

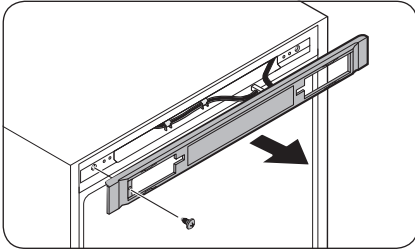

1. Remove the screw and pull out the control cover.

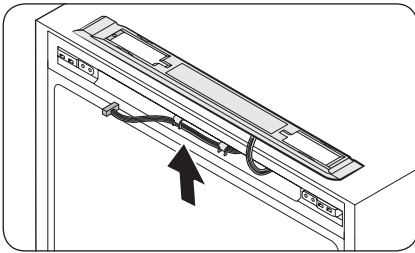

2. Move the connectors and wires to the opposite side. Insert the control cover, and then tighten the screws on the opposite side.

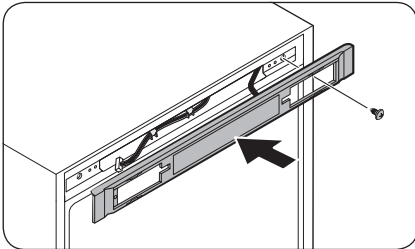

Maintenance

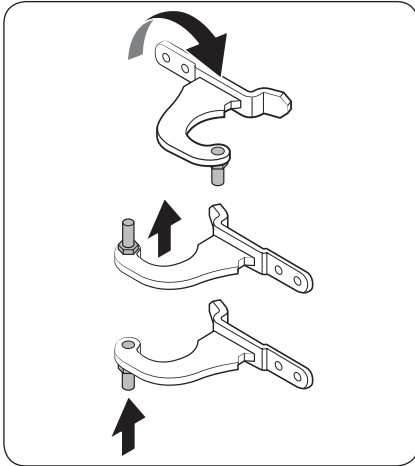

3. Remove the **shaft** from the **top hinge**. Then, reassemble the **shaft** as shown.

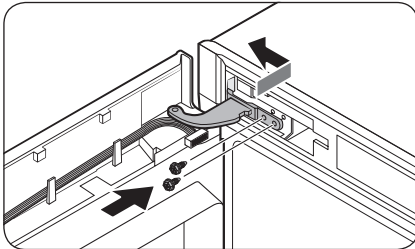

4. Insert the bottom of the door first into the main unit.
5. Insert the **top hinge** and tighten it with screws.

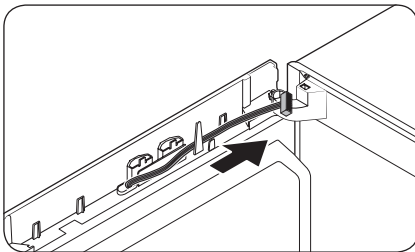

- Move the wires to the opposite side and fix them on the inner hook of the opposite side.

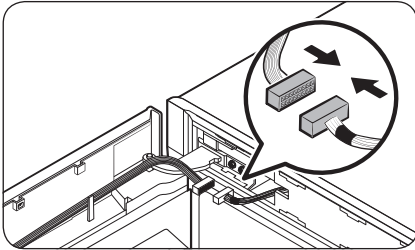

6. Connect the connectors from the fridge door and the main unit. Then, fix the wires on the inner hook of the optional hinge cover (L).

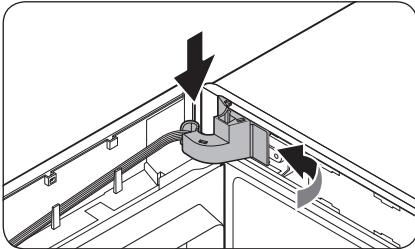
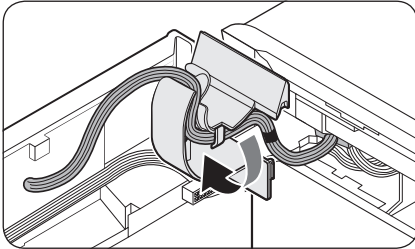

7. Insert the hinge cover in the top hinge with the right side first. Then, press the bottom of the cover to fit.

⚠ CAUTION

Make sure all of the wires and connectors are not stuck in the middle.

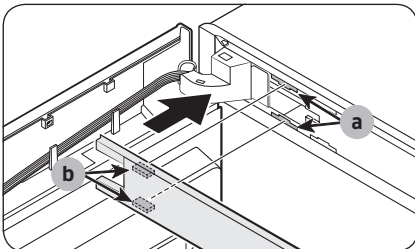

8. Insert the top frame cover with the part (b) fitting in the part (a) diagonally.

Maintenance

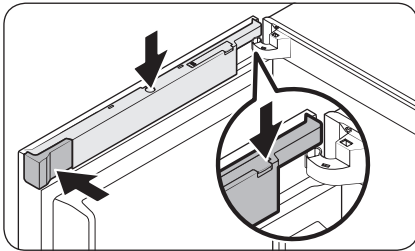
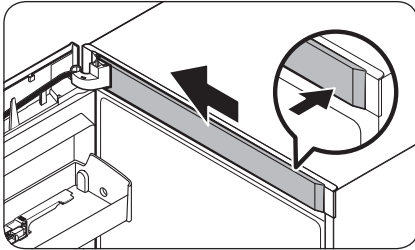

9. Insert the **wire cover**. Turn the cover by 90 degrees to the front, and then push down to fit in.

10. Insert the **space cover (L)** into the original position.

NOTE

The appearance of the covers differ with the model.

Display Type B

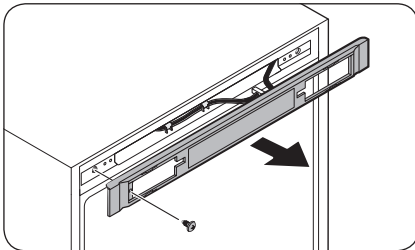

1. Remove the screw and pull out the **control cover**.

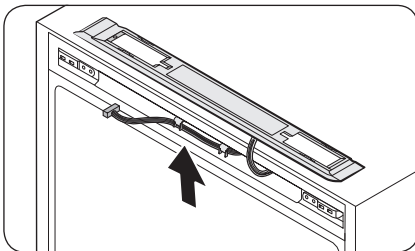

2. Move the connectors and wires to the opposite side. Insert the **control cover**, and then tighten the screws on the opposite side.

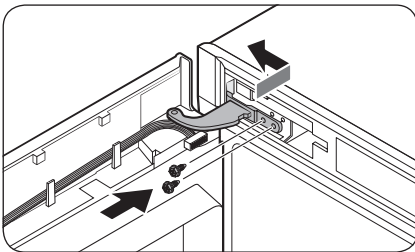
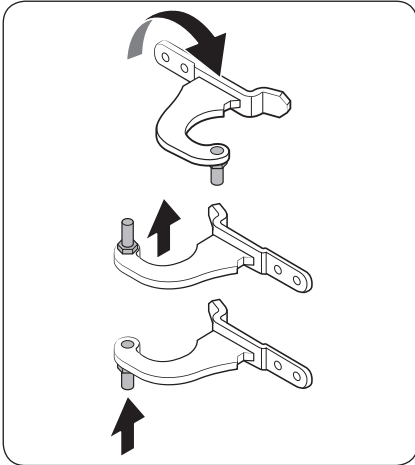
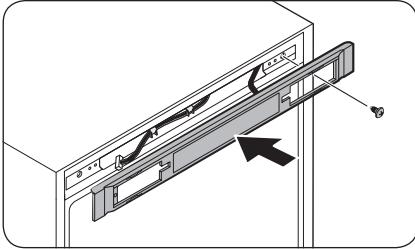

3. Remove the **shaft** from the **top hinge**.
Then, reassemble the **shaft** as shown.

4. Insert the bottom of the door first into the main unit.
5. Insert the **top hinge** and tighten it with screws.

Maintenance

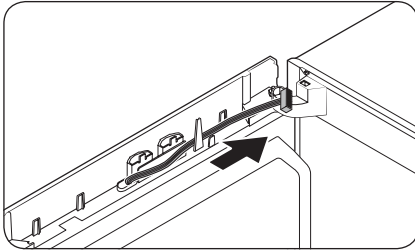

- Move the wires to the opposite side and fix them on the inner hook of the opposite side.

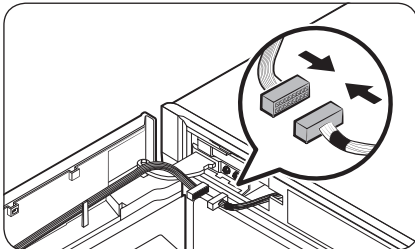

6. Connect the connectors from the fridge door and the main unit. Then, fix the wires on the inner hook of the optional hinge cover (L).

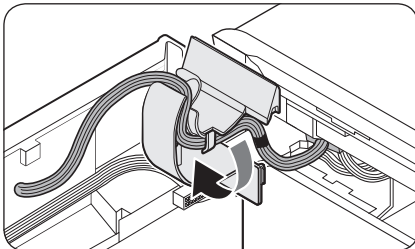

7. Insert the hinge cover in the top hinge with the right side first. Then, press the bottom of the cover to fit.

⚠ CAUTION

Make sure all of the wires and connectors are not stuck in the middle.

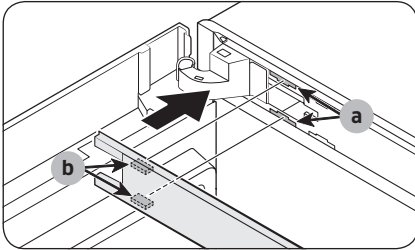

8. Insert the **top frame cover** with the **part (b)** fitting in the **part (a)** diagonally. Then, slide the end of the cover to the left to lock.

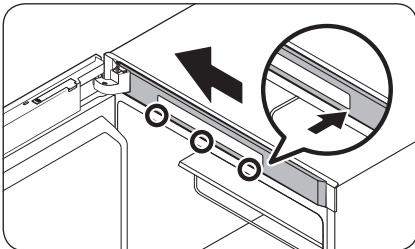
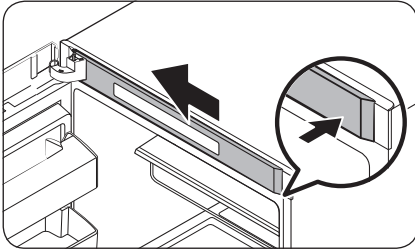

- For models that have the display panel on the top of the fridge, push in the left end of the **top frame cover** then the right side by locking the lower and upper areas in this sequence.

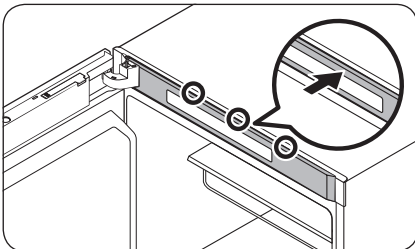

Maintenance

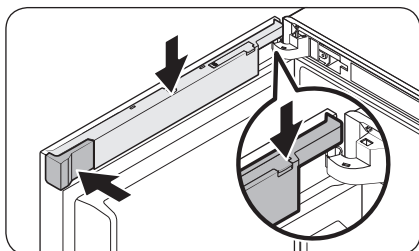

9. Insert the **wire cover**. Turn the cover by 90 degrees to the front, and then push down to fit in.
10. Insert the **space cover (L)** into the original position.

NOTE

The appearance of the covers differ with the model.

STEP 6 Reattach the handle

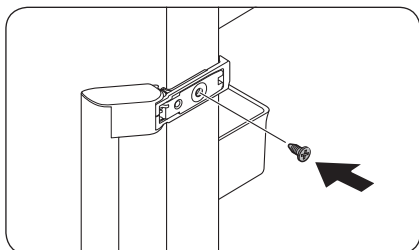

1. Insert the handle in the opposite side, and then tighten the screw.

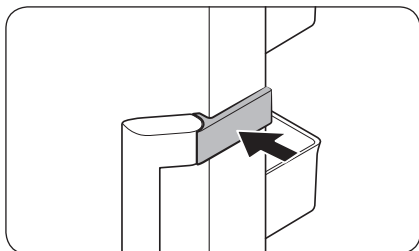

2. Close the **handle cover** as shown.

NOTE

You might want to return the doors to the initial position (before reversing the door). In that case, refer to the instructions above but switch the doors, hinges, and covers back to the initial position.

Handle and care

Shelves / Wine Rack (applicable models only)

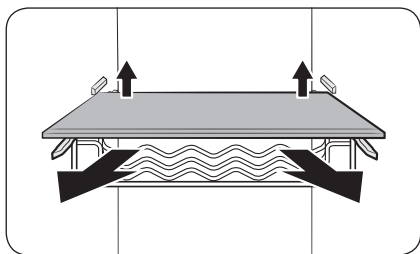

Slightly lift up the rear side of the shelf (or wine rack) to pull out.

Foldable shelf

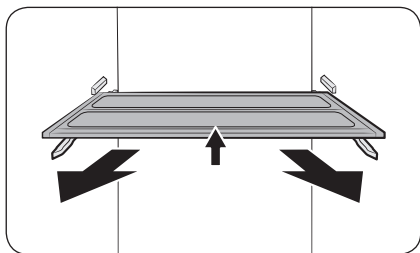

1. Slightly lift up the front side of the shelf to pull out.
2. Twist the shelf diagonally to remove.

⚠ CAUTION

- The shelf must be inserted correctly. Do not insert upside down.
- When reinserting the shelf, make sure to push in the shelf to the end until it fits.
- Glass containers may scratch the surface of glass shelves.

Door guards

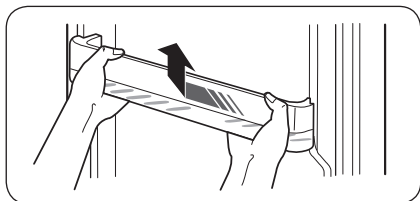

Slightly lift up and pull out the door guard.

⚠ CAUTION

To prevent accidents, empty the door guards before removing.

Maintenance

Cleaning

Interior and exterior

WARNING

- Do not use benzene, thinner, or home/car detergent such as Clorox™ for cleaning purposes. They may damage the surface of the refrigerator and cause a fire.
- Do not spray water onto the refrigerator. This may cause electric shock.

Regularly use a dry cloth to remove all foreign substances such as dust or water from the power plug terminals and contact points.

1. Unplug the power cord.
2. Use a moistened, soft, lint-free cloth or paper towel to clean the refrigerator's interior and exterior.
3. When done, use a dry cloth or paper towel to dry well.
4. Plug in the power cord.

Replacement

LED Lamps

To replace the lamps of the refrigerator, contact a local Samsung service centre.

WARNING

- The lamps are not user-serviceable. Do not attempt to replace a lamp yourself. This can cause electric shock.

Lamp (Light Source)

This product contains a light source of energy efficiency class <G>.

The lamp(s) and/or control gear(s) are not user-serviceable. To replace the lamp(s) and/or control gear(s) in the product, contact a local Samsung service centre.

For detailed instructions on replacing lamp(s) or control gear(s) in your product, visit the Samsung website (<http://www.samsung.com>), go to Support > Support home, and then enter the model name.

For detailed instructions on dismantling lamp(s) and/or control gear(s), simply follow the replacement instruction reached as described above.

Side-by-side installation

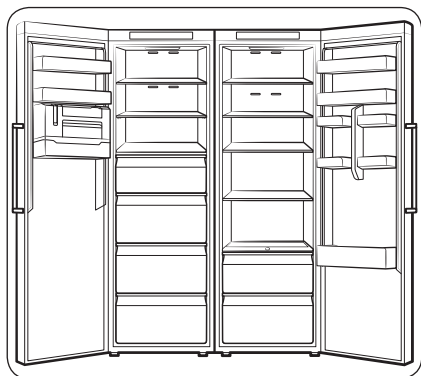

You can install this refrigerator with another Samsung refrigerator side by side if you want to. However, this side-by-side installation is only available with models whose name starts with RZ or RR.

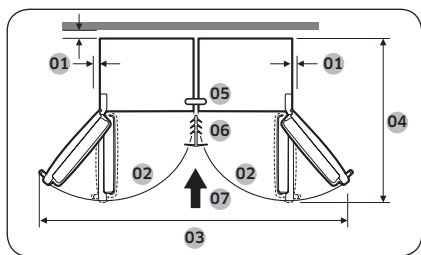

01	more than 50 mm recommended
02	130°
03	1939 mm
04	1194 mm
05	Locker fixer
06	Fixer
07	Install direction

Installation kit

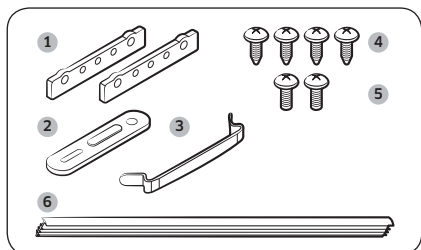

No.	PART NAME	Q'ty
1	Rear reinforced hinges	2
2	Locker fixer	1
3	Bottom reinforced hinge	1
4	Tapping screws (A)	4
5	Tapping screws (B)	2
6	Fixer	1

Maintenance

How to install

Make sure to power off both refrigerators.

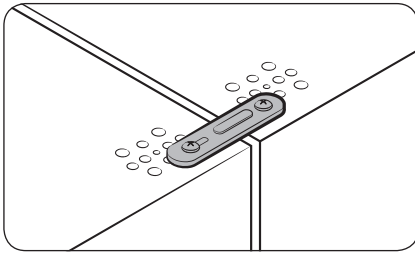

1. Join the top sides of the two refrigerators using the **locker fixer** and the **tapping screws**.

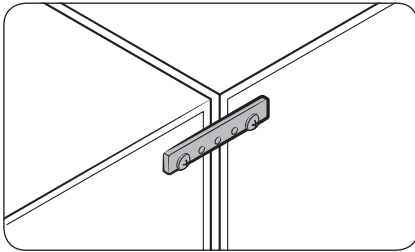

2. Join the upper and lower rear sides of the two refrigerators using the **rear reinforced hinges** and the **tapping screws**.

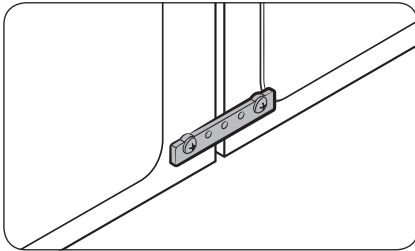

3. Join the legs of the two refrigerators using the **bottom reinforced hinge** and the **tapping screws**.

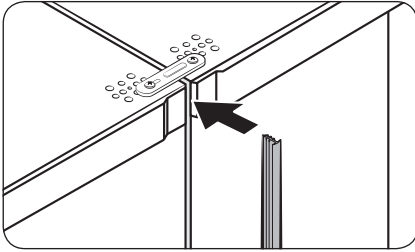

4. Insert one end of the fixer between the two top front covers by making a gap.

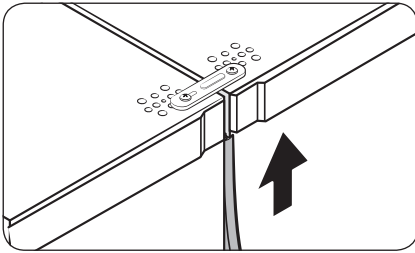

5. Push the fixer all the way up.

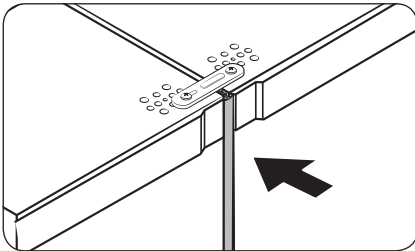

6. Press down the other end to fix into place.

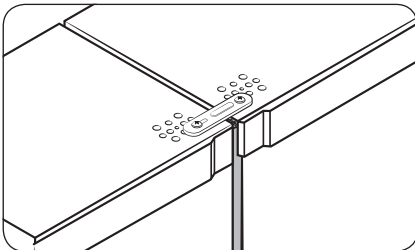

Troubleshooting

Before calling for service, review the checkpoints below. Any service calls regarding normal situations (No Defect Cases) will be charged to users.

General

Temperature

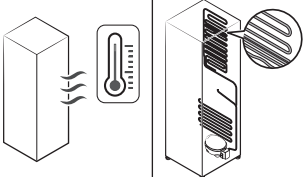
Symptom	Possible causes	Solution
Fridge does not operate. Fridge temperature is warm.	<ul style="list-style-type: none"> Power cord is not plugged in properly. 	<ul style="list-style-type: none"> Properly plug in the power cord.
	<ul style="list-style-type: none"> Temperature control is not set correctly. 	<ul style="list-style-type: none"> Set the temperature lower.
	<ul style="list-style-type: none"> Refrigerator is located near a heat source or direct sunlight. 	<ul style="list-style-type: none"> Keep the refrigerator away from direct sunlight or a heat source.
	<ul style="list-style-type: none"> Not enough clearance between refrigerator and sides/rear. 	<ul style="list-style-type: none"> We recommend that the gap between the refrigerator and nearby walls (or cabinets) is more than 50 mm.
	<ul style="list-style-type: none"> Vacation mode is activated. 	<ul style="list-style-type: none"> Deactivate vacation mode.
	<ul style="list-style-type: none"> The refrigerator is overloaded. Food is blocking the refrigerator vents. 	<ul style="list-style-type: none"> Do not overload the refrigerator. Do not allow food to block ventilation.
Fridge is over-cooling.	<ul style="list-style-type: none"> Temperature control is not set correctly. 	<ul style="list-style-type: none"> Set the temperature higher.
Interior wall is hot.	<ul style="list-style-type: none"> Refrigerator has heat-proof piping in the interior wall. 	<ul style="list-style-type: none"> To prevent condensation from forming, the refrigerator has heat-proof piping in the front corners. If the ambient temperature rises, this equipment may not work effectively. This is not a system failure. 

Odors

Symptom	Possible causes	Solution
Refrigerator has odors.	• Spoiled food.	• Clean the refrigerator and remove any spoiled food.
	• Food with strong odors.	• Make sure strong smelling food is wrapped airtight.

Condensation

Symptom	Possible causes	Solution
Condensation forms on the interior walls.	• If door is left open, moisture enters the refrigerator.	• Remove the moisture and do not open the door for a long time.
	• Food with high moisture content.	• Make sure food is wrapped airtight.

Troubleshooting

Do you hear abnormal sounds from the refrigerator?

Before calling for service, review the checkpoints below. Any service calls related to normal sounds will be charged to the user.

These sounds are normal.

- When starting or ending an operation, the refrigerator may make sounds similar to a car engine igniting. As the operation stabilizes, the sounds will decrease.

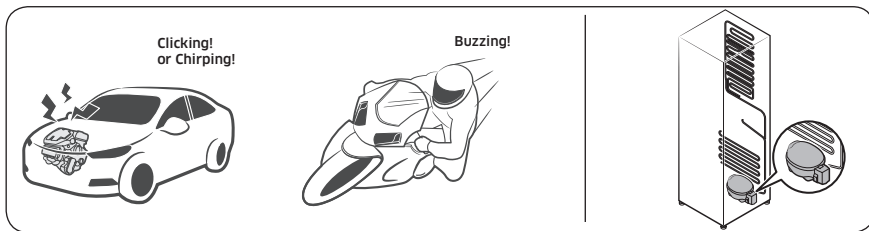

- While the fan is operating, these sounds may occur. When the refrigerator reaches the set temperature, no fan sound will occur.

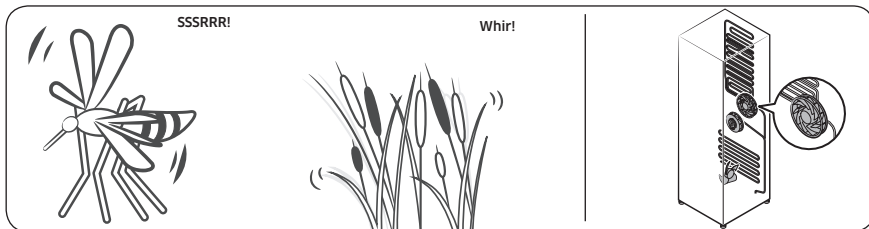

- As the refrigerator cools, refrigerant gas moves through sealed pipes, causing bubbling sounds.

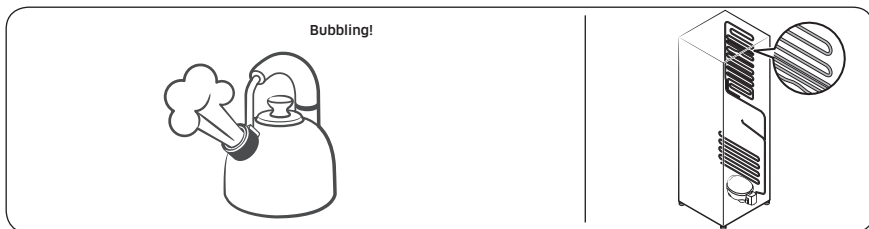

-
- As the refrigerator temperature increases or decreases, plastic parts contract and expand, creating knocking noises. These noises occur during the defrosting cycle or when electronic parts are working.

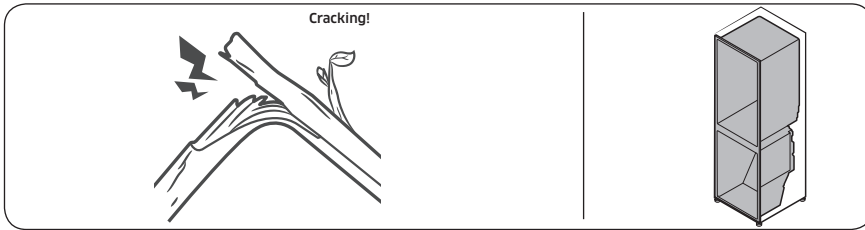

- For ice maker models: When the water valve opens to fill the ice maker, buzzing sounds may occur.
- Due to pressure equalizing when opening and closing the refrigerator door, whooshing sounds may occur.

Appendix

Safety Instruction

- For the most efficient use of energy, please keep the all inner fittings such as baskets, drawers, shelves and ice cube tray on the position supplied by manufacturer.
- This refrigerating appliance is not intended to be used as a built-in appliance.

Install Instruction

For refrigerating appliances with climate class

Depending on the climate class, This refrigerating appliance is intended to be used at ambient temperatures range as specified following table.

The climate class can be found on the rating plate. The product may not operate properly at temperatures outside of the specific range.

You can find climate class on label inside of your refrigerator

Effective temperature range

The refrigerator is designed to operate normally in the temperature range specified by its class rating.

Class	Symbol	Ambient Temperature range (°C)	
		IEC 62552 (ISO 15502)	ISO 8561
Extended Temperate	SN	+10 to +32	+10 to +32
Temperate	N	+16 to +32	+16 to +32
Subtropical	ST	+16 to +38	+18 to +38
Tropical	T	+16 to +43	+18 to +43

NOTE

The cooling performance and power consumption of the refrigerator may be affected by the ambient temperature, the door-opening frequency, and the location of the refrigerator. We recommend adjusting the temperature settings as appropriate.

Temperature Instruction

Recommended Temperature

The optimal temperature setting for food storage:

- Fridge: 3 °C

NOTE

The optimal temperature setting of each compartment depends on the ambient temperature. Above optimal temperature is based on the ambient temperature of 25 °C.

Power Cool

Power Cool speeds up the cooling process at maximum fan speed. The fridge keeps running at full speed for two and a half hours and then returns to the previous temperature.

Power Freeze

Power Freeze speeds up the freezing process at maximum fan speed. The freezer keeps running at full speed for 50 hours and then returns to the previous temperature. To freeze large amounts of food, activate Power Freeze for at least 20 hours before putting food in the freezer.

NOTE

When you use this function the energy consumption of the refrigerator will increase. Remember to turn it off when you don't need it and return the freezer to your original temperature setting.

How to store for best preservation (applicable models only)

Cover foods to retain moisture and prevent them from picking up odors from other foods. A large pot of food like soup or stew should be divided into small portions and put in shallow containers before being refrigerated. A large cut of meat or whole poultry should be divided into smaller pieces or placed in shallow containers before refrigerating.

Placement of Foods

Shelves	Shelves should be adjustable to accommodate a variety of packages.
Specialized compartment (applicable models only)	Sealed crisper drawers provide an optimal storage environment for fruits and vegetables. Vegetables require higher humidity conditions while fruits require lower humidity conditions. Crispers are equipped with controls devices to control the humidity level. (*Depending on model and options) An adjustable temperature meat drawer maximizes the storage time of meats and cheeses.

Appendix

Stored on the door	Don't store perishable foods in the door. Eggs should be stored in the carton on a shelf. The temperature of the storage bins in the door fluctuate more than the temperature in the cabinet. Keep the door closed as much as possible.
Freezer Compartment	You can store frozen food, make ice cubes and freeze fresh food in the freezer compartment.

NOTE

Freeze fresh, undamaged food only. Keep food which is to be frozen away from food which is already frozen. To prevent food from losing its flavour or drying out, place in airtight containers.

Refrigerator & Freezer Storage Chart

The freshness longevity depends on temperature and exposure to moisture. Since product dates aren't a guide for safe use of a product, consult this chart and follow these tips.

Milk products

Product	Refrigerator	Freezer
Milk	1 week	1 month
Butter	2 weeks	12 months
Ice cream	-	2-3 weeks
Natural cheese	1 month	4-6 months
Cream cheese	2 weeks	Not recommended
Yogurt	1 month	-

Meat

Product	Refrigerator	Freezer
Fresh roasts, steaks, chops	3-4 days	2-3 months
Fresh ground meat, stew meat	1-2 days	3-4 months
Bacon	7 days	1 month
Sausage, Raw from pork, beef, turkey	1-2 days	1-2 months

Poultry / Eggs

Product	Refrigerator	Freezer
Fresh poultry	2 days	6-8 months
Poultry salad	1 day	-
Eggs, Fresh in shell	2-4 weeks	Not recommended

Fish / Seafood

Product	Refrigerator	Freezer
Fresh fish	1-2 days	3-6 months
Cooked fish	3-4 days	1 month
Fish salad	1 day	Not recommended
Dried or pickled fish	3-4 weeks	-

Fruits

Product	Refrigerator	Freezer
Apples	1 month	-
Peaches	2-3 weeks	-
Pineapple	1 week	-
Other fresh fruit	3-5 days	9-12 months

Vegetables

Product	Refrigerator	Freezer
Asparagus	2-3 days	-
Broccoli, Brussels sprouts, green peas, mushrooms	3-5 days	-
Cabbage, cauliflower, celery, cucumbers, lettuce	1 week	-
Carrots, beets, radishes	2 weeks	-

Appendix

Information for model and ordering spare parts

Model information

To access the EPREL registration of the model :

1. Go to <https://eprel.ec.europa.eu>
2. Get the model identifier from the energy label of the product and type it in the search box
3. Energy Labelling information of the model is shown

Part information

- The minimum period during which spare parts, necessary for the repair of the appliance, are available
 - 7 Years thermostats, temperature sensors, printed circuit boards and light sources, door handles, door hinges, trays, baskets (boxes or drawers)
 - 10 Years door gaskets
- The minimum duration of the guarantee of the refrigerating appliance offered by the manufacturer 24 Months.
- Relevant information for ordering spare parts, directly or through other channels provided by the manufacturer, importer or authorized representative
- You can find professional repair information on <http://samsung.com/support>. You can find user servicing manual on <http://samsung.com/support>.

Memo

Memo

Memo

Contact SAMSUNG WORLD WIDE

If you have any questions or comments relating to Samsung products, please contact the SAMSUNG customer care center.

Country	Contact Center	Web Site
SINGAPORE	1800 7267864 1800-SAMSUNG (Other) 1800 4252997 1800-GALAXYS (HHP)	www.samsung.com/sg/support
UK	0333 000 0333	www.samsung.com/uk/support
SOUTH AFRICA	0860 SAMSUNG (726 7864)	www.samsung.com/za/support



DA68-03560A-07