

INSTRUCTION MANUAL



McGregor 320W Grass Trimmer

7269703 (Model: MCEGT3223)
Version no. Apr 2025

Important - Please read these instructions fully before starting assembly

These instructions contain important information that will help you get the best from your trimmer, ensuring it is assembled correctly and safely. If you need help or have damaged or missing parts, call the After Sales Support on **0345 605 2063**

AFTER SALES SUPPORT
0345 605 2063

Contents

Safety Information	3
Warning Symbols	3
Personal Safety	5
Operational Safety	7
Maintenance and Storage Safety	8
Intended Use	9
In the Box	10
Parts	10
Assembly	11
Unpacking	11
Assembling the upper and lower	11
Fitting the plant guard	12
Fitting the safety guard	12
Preparation	13
Connection to the power supply	13
Operation	14
Switching on/off	14
Safety guard	14
Advancing the cutting line	14
Plant guard	15
Trimming	16
Warning	16
Tips	17
Maintenance	18
Replacing the spool	18
Winding the line	18
Storage	19
Transportation	19
After use	19
Recycling and disposal	19
Technical Data	20
Technical Data Table	20
Part List	20
Troubleshooting	22
General Troubleshooting	22
Getting Help	23
After Sales Support	23
Guarantee	23

Produced in China for Argos Limited. London, EC1M 6HA, UK.
Argos (N.I.) Ltd, Forestside Shopping Centre, Upper Galwally, Belfast, BT8 6FX, UK.
argos.co.uk/help/contact-us



Safety Information

Important - Please read these instructions fully before starting assembly

Warnings Symbols

The following warning symbols appear throughout this instruction manual and indicate the appropriate safety measures you should take when assembling and operating the trimmer.



Read operator's manual.



Wear eye protection.



Wear hearing protection.



Do not expose to rain.



Keep bystanders away.



Disconnect the mains plug if the cord becomes damaged or entangled.



Noise level specification Lwa in dB.



Do not dispose of electrical equipment in domestic waste.



Protection class II (Double insulation).



The product complies with the applicable European directives and an evaluation method of conformity for these directives was followed.



The product conforms to relevant UK regulatory requirements.



Safety Information

Important - Please read these instructions fully before starting assembly

Warnings Symbols (continued)



IMPORTANT! When using equipment, the following safety precautions must be followed to avoid injuries and damage.

- Read all operating instructions carefully and comply with them. It is important to understand these instructions and to acquaint yourself with the machine, its correct usage and all safety requirements.
- Keep this manual in a safe place so that the information is available at all times.
- If you give the equipment to any other person, give them these operating instructions as well.
- We accept no liability for damage or accidents which result from non-compliance with these instructions.

Work Area

- Only work in good daylight or appropriate and adequate artificial light.
- Do not operate machine in explosive atmospheres, such as in the presence of flammable liquids, gases, or dust. Power tools create sparks which may ignite the dust or fumes.
- Keep children and bystanders away while operating the trimmer. Distractions can cause you to lose control.
- Stay alert, watch what you are doing and use common sense when operating a trimmer. Do not use a grass trimmer while you are tired or under the influence of drugs, alcohol, or medication. A moment of inattention while operating the appliance may result in serious personal injury.



Safety Information

Important - Please read these instructions fully before starting assembly

Personal Safety

- Use protective safety equipment where appropriate. Always wear eye and hearing protection. The use of non-slip safety shoes will reduce personal injuries.
- Avoid accidental starting. Ensure the switch is in the off-position before plugging in. Carrying tools with your finger on the switch invites accidents.
- Ensure you always have proper footing and balance. This will provide better control of the machine in unexpected situations.
- Do not wear loose clothing or jewellery. They can be caught in moving parts. Use of safety gloves and substantial footwear is recommended when working outdoors.
- Do not use the machine for applications that are beyond its capacity. Use the correct machine for your application. The correct appliance will do the job better and more safely at the rate for which it was designed.
- Do not use the machine if the switch does not turn it ON and OFF. Any tool that cannot be controlled with the switch are dangerous and must be repaired.
- Disconnect the plug from the power source before making any adjustments, changing accessories, or storing tools. Such preventive safety measures reduce the risk of starting the trimmer accidentally.
- Store the machine out of the reach of children. Do not allow people unfamiliar with the trimmer or these instructions to operate the machine.



Safety Information

Important - Please read these instructions fully before starting assembly

Personal Safety (continued)

- Always maintain the grass trimmer in good working order. Check for misalignment or binding of moving parts, breakage of parts, or other conditions that would affect its operation. If damaged, have the machine repaired before use.
- Keep cutting tools sharp and clean. Properly maintained cutting attachments with sharp cutting edges are less likely to bind and are easier to control.
- Only use the tool, accessories, and attachments as described in these instructions. Using the tool for operations it is not intended for could cause damage to the tool and hazardous situations. Always consider the working conditions and the work to be performed.
- We recommend that only parts and accessories made for this machine by the manufacturer are used. Failure to do so can result in personal injury.
- When starting up and when the machine is in operation, keep the cutting section away from all parts of the operators body, especially the hands and feet.
- This appliance can be used by children aged from 8 years and above and persons with reduced physical, sensory or mental capabilities or lack of experience and knowledge if they have been given supervision or instruction concerning use of the appliance in a safe way and understand the hazards involved.
- Children shall not play with the appliance. Cleaning and user maintenance shall not be made by children without supervision.



Safety Information

Important - Please read these instructions fully before starting assembly

Operational Safety

- The user remains responsible for any injury to third parties within the working area whilst the trimmer is being used.
- Do not expose the appliance to rain. Do not use the appliance in damp or wet conditions.
- Be sure that the appliance is switched off before connecting it to the mains supply.
- Stay alert at all times. Watch carefully what you are doing. Use common sense.
- Do not operate the appliance when you are tired.
- If the appliance begins to vibrate abnormally, switch it off and remove the plug from the socket. Allow rotating parts to stop and inspect the appliance for damage and loose parts.
- Never pull the cord to disconnect the plug from the socket. Keep the cord away from heat, oil and sharp edges.
- If the mains cable becomes damaged during use, switch the appliance off and disconnect the plug from the mains immediately. Do not touch the mains cable before disconnecting from the power outlet.
- Remember that the operator maybe held responsible for the accidents or hazards occurring to other people or their property.



Safety Information

Important - Please read these instructions fully before starting assembly

Maintenance And Storage Safety

- Switch off, remove the plug from the power outlet and ensure that all moving parts have stopped completely before leaving the appliance unattended and before changing, cleaning or inspecting any parts.
- When not in use, the appliance should be stored in a safe, dry place. Children should not have access to stored appliances.
- Before each use, inspect the trimmer for damaged or defective parts. Check for misalignment and seizure of moving or broken parts, damage to guards and switches or any other conditions that may affect its operation.
- Do not use the appliance if any part is damaged or defective. Do not use the appliance if the switch does not turn it on and off.
- Never use the appliance when any guard or housing elements are damaged or not in place.
- Ensure that the appliance will operate properly and perform its intended function.
- Damaged parts on the trimmer must be replaced by a qualified person.
- Before use, check the mains cable for signs of damage, ageing or wear.
- Do not use the appliance if the mains cable is damaged or defective.
- If the mains cable is damaged or defective it must immediately be repaired by a qualified person to avoid any further hazard.
- Never attempt to remove or replace any parts other than those specified in this manual.



Safety Information

Important - Please read these instructions fully before starting assembly

Intended use

This grass trimmer is designed for domestic use only:

- This trimmer is intended for trimming lawn grass in domestic gardens.
- This product is not to be used in wet weather conditions and may not be used to trim wet or unusually high grass.
- This product is intended for private domestic use only, and not for any commercial trade use.

It must not be used for any purposes other than those described. Any use of the machine that deviates from its intended use and is not included in these instructions is considered unauthorized use and relieves the manufacturer from his or her legal liability.

In the Box

Parts

- | | | | |
|----------------------------|--|--------------------------------|------------------|
| 1 ON/OFF Switch | 4 Upper Shaft | 7 Cutting Line | 10 Motor Housing |
| 2 Cable Strain Relief Hook | 5 Lower Shaft | 8 Trimmer Head with Line Spool | 11 Front Handle |
| 3 Mains Cable | 6 Safety Guard with Line Cutting Blade | 9 Plant Guard | 12 Main Handle |

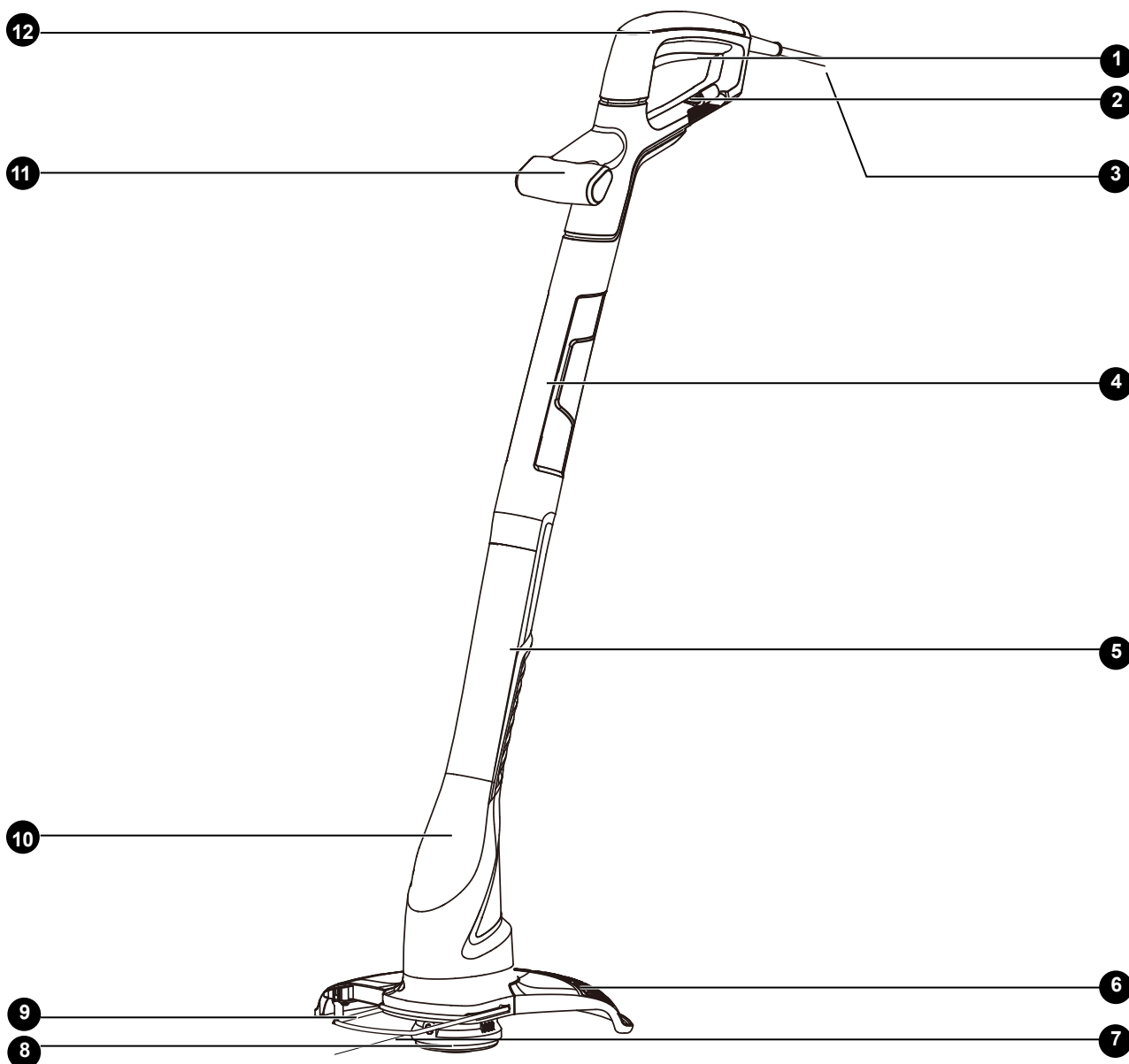

Assembly

Unpacking

- Unpack all parts and lay them on a flat, stable surface.
- Remove all packing materials.
- Make sure the delivery contents are complete and free of any damage. If you find that parts are missing or show damage do not use the product but contact after sales support. Using an incomplete or damaged product represents a hazard to people and property.
- Ensure that you have all the accessories and tools needed for assembly and operation. This also includes suitable personal protective equipment.

Assembling the upper and lower

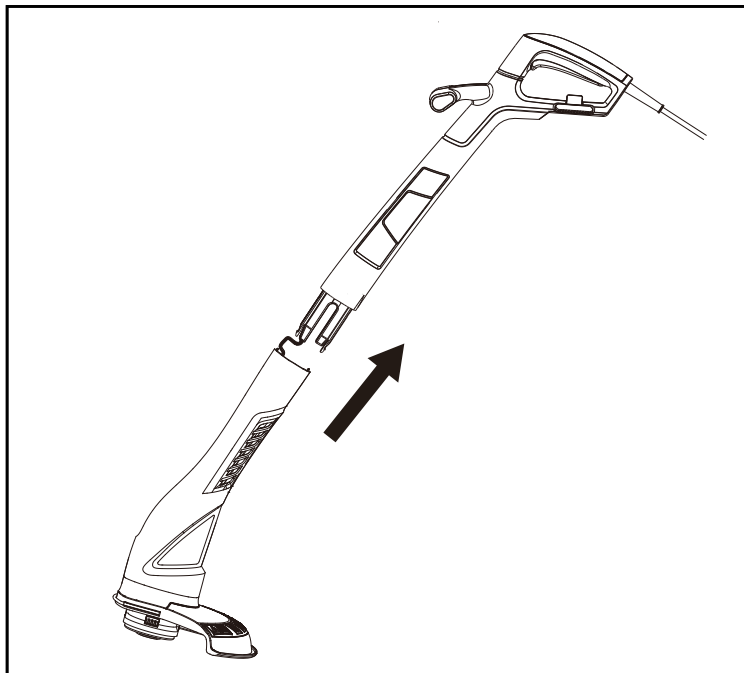

- Insert the upper and lower shaft handles securely into the correct housing position and ensure they are fully engaged and locked into position.



WARNING! Be careful do not damage cable.

Assembly

Fitting the plant guard

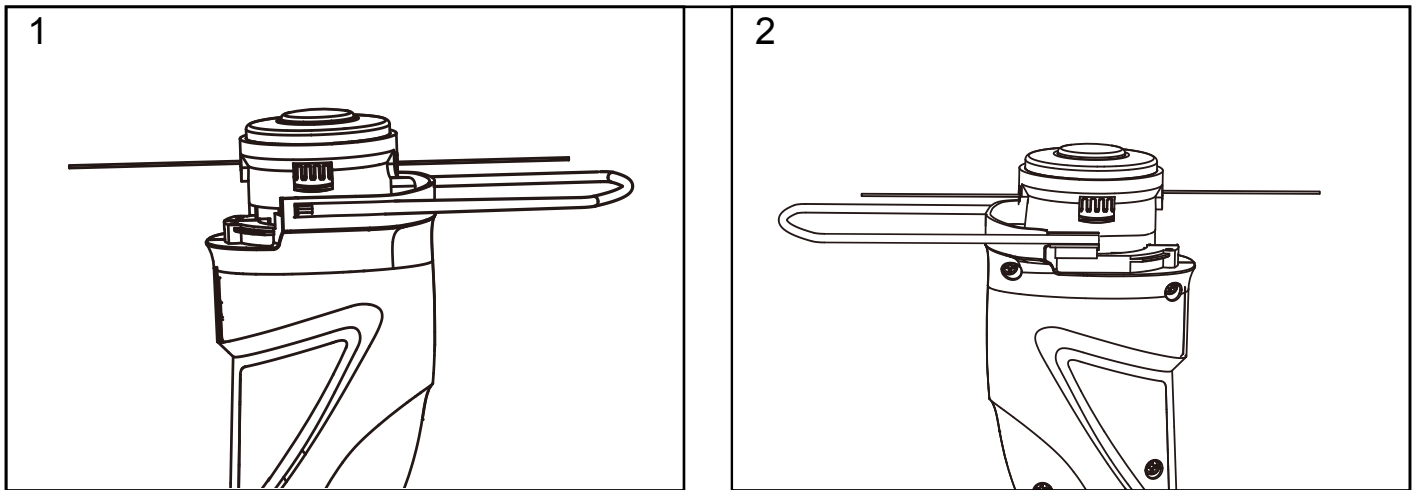

- Insert one end of the plant guard into the channel on the side of the motor housing, making sure it is secured in place. Apply outward pressure to the other side and insert it into the opposite channel.

Fitting the safety guard

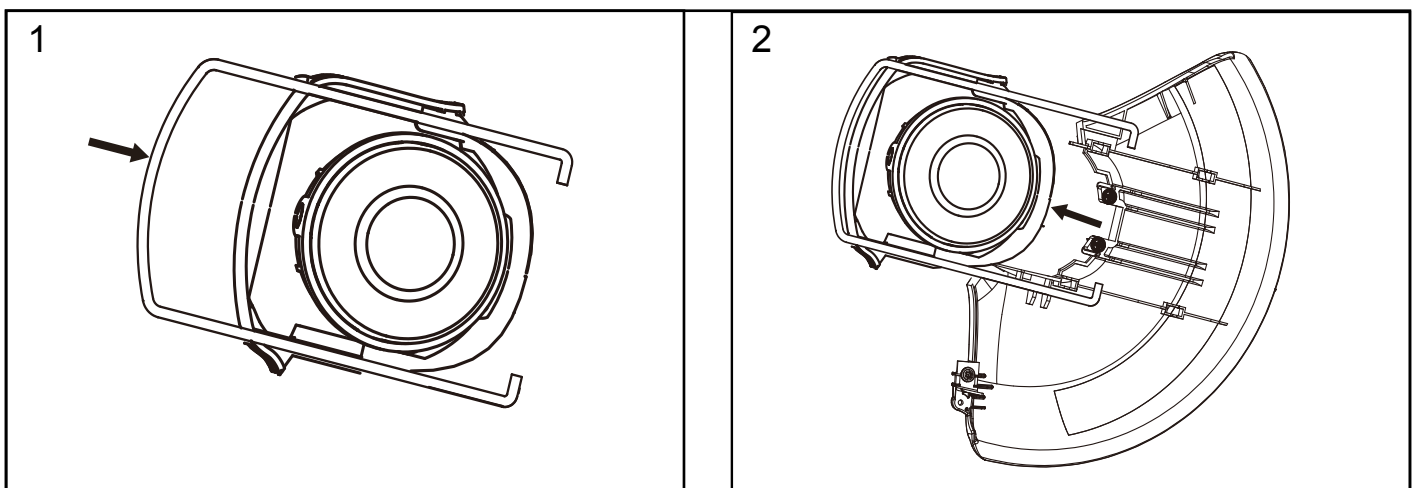

- Push the plant guard inward.
- Place the safety guard onto the underside of the grass trimmer.
- Make sure the plant guard is on the slots of the safety guard.
- Secure the safety guard with 2 screws (pre-installed on the safety guard) provided using a Phillips screwdriver (not supplied).



WARNING! Never use the grass trimmer unless the safety guard is properly fitted.

Preparation

Connection to the power supply

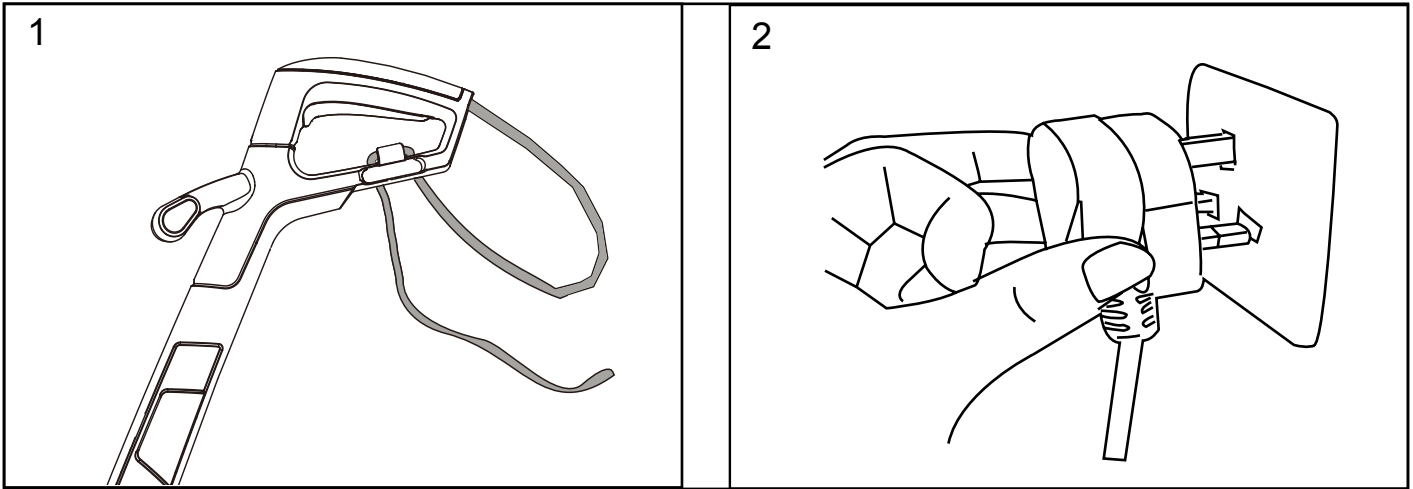

- Hook the mains cable through the cable strain relief hook.
- Check cutting line length. if the cutting length needs to be adjusted, refer to page 14 for method of both manual or bump.
- Connect the plug to the power outlet.

Operation

Switching on/off

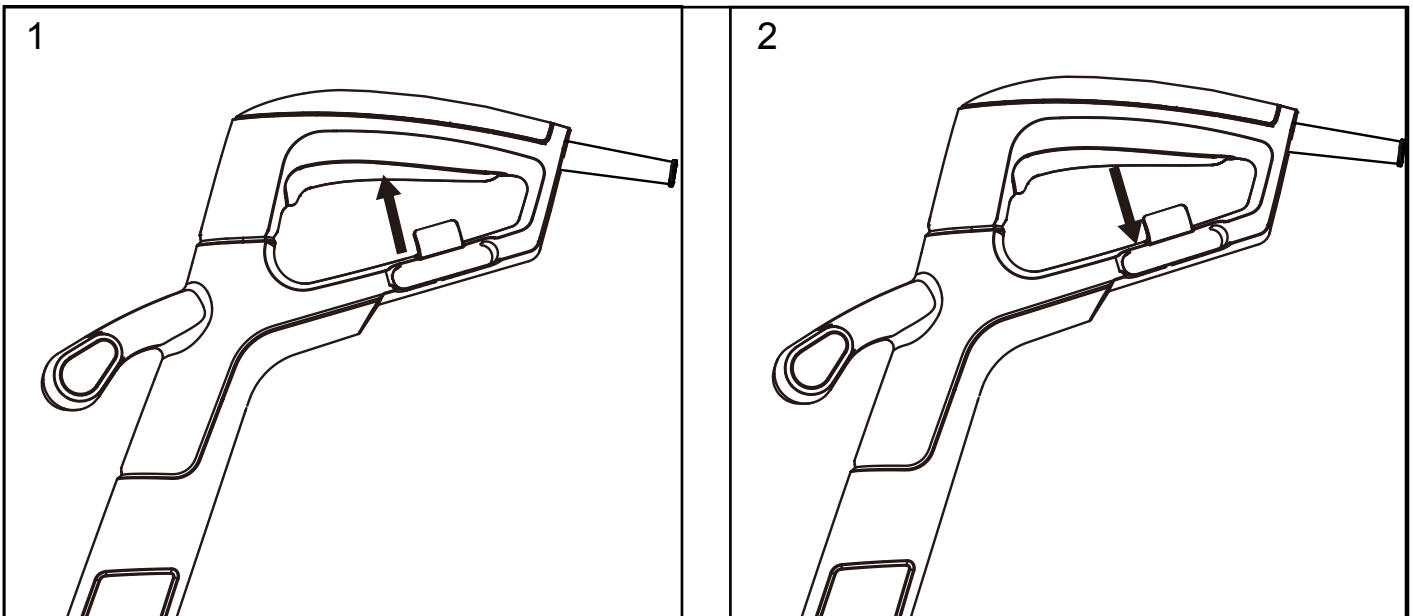

- To switch on, press the ON/OFF switch.
- To switch off, release the switch.

Safety Guard



WARNING!

The line cutting blade on the safety guard is delivered with a protective covering. Ensure this is removed before first use. Beware of sharp edges.

The device is fitted with a safety guard to protect the operator against thrown objects during operation. Ensure this is always fitted.

Advancing the cutting line



This trimmer features a bump line feed. In order to advance the cutting line, firmly tap the bump cap on the trimmer head while the trimmer is running. This will automatically advance a new length of trimmer line and trim the line to the correct length. A firm but gentle motion should be used when tapping the bump cap on the lawn. This advancing process may be repeated as often as necessary. Never try to advance the line on a hard surface. If the unit fails to advance, stop and unplug the trimmer, clean the bump cap both inside and out.

NOTE: Regularly check the cutting line for damage and whether the lines still have the correct length defined by the line cutting blade.



WARNING!

The excess line that is cut off has a chance of hitting the user or other objects. Keep hands and feet well away. Beware of sharp edges.

When no line end is visible:

Replace the line spool (see Replacing the Spool instructions in the Maintenance section).

Operation

Advancing the cutting line (continued)

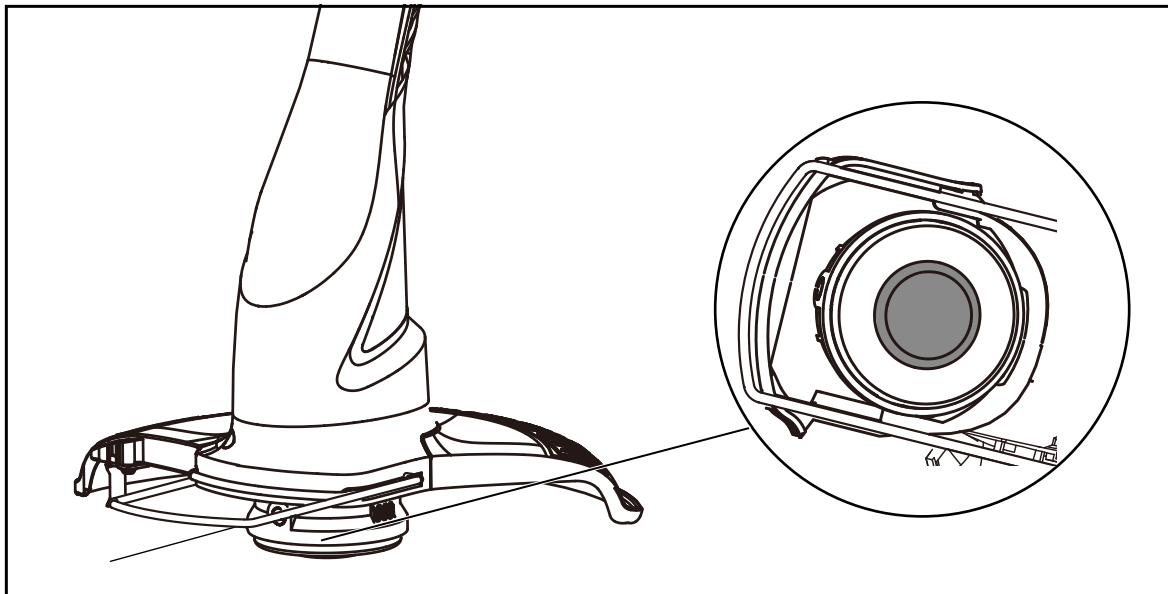

Plant guard



WARNING!

Only adjust the plant guard position when the product is switched off and the trimmer head is at a complete stop.

Use the plant guard to keep a safe distance from trees and flowers or other objects that could be hit by the cutting line.

Push the plant guard to its outer position for operation until it snaps into place.

Push the plant guard to its inner position until it snaps into place after operation and when storing.

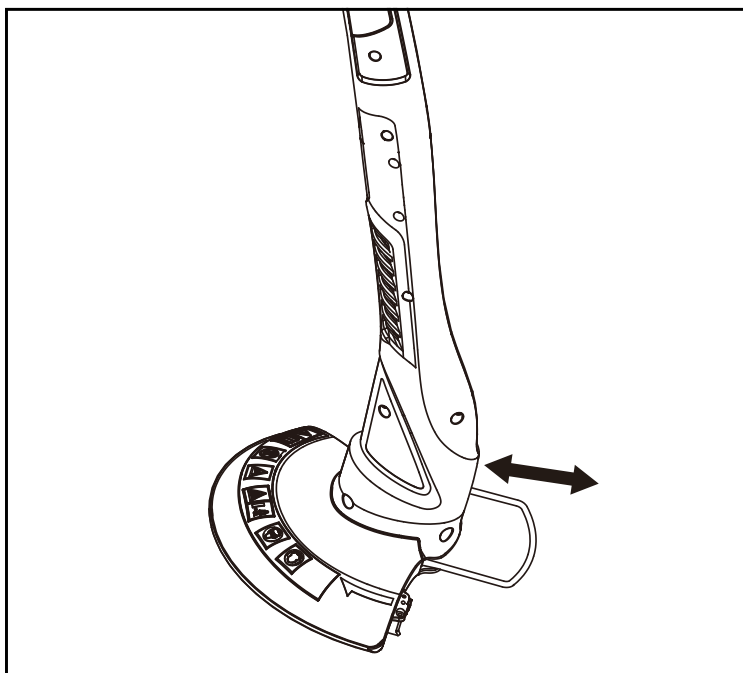

Operation

Trimming

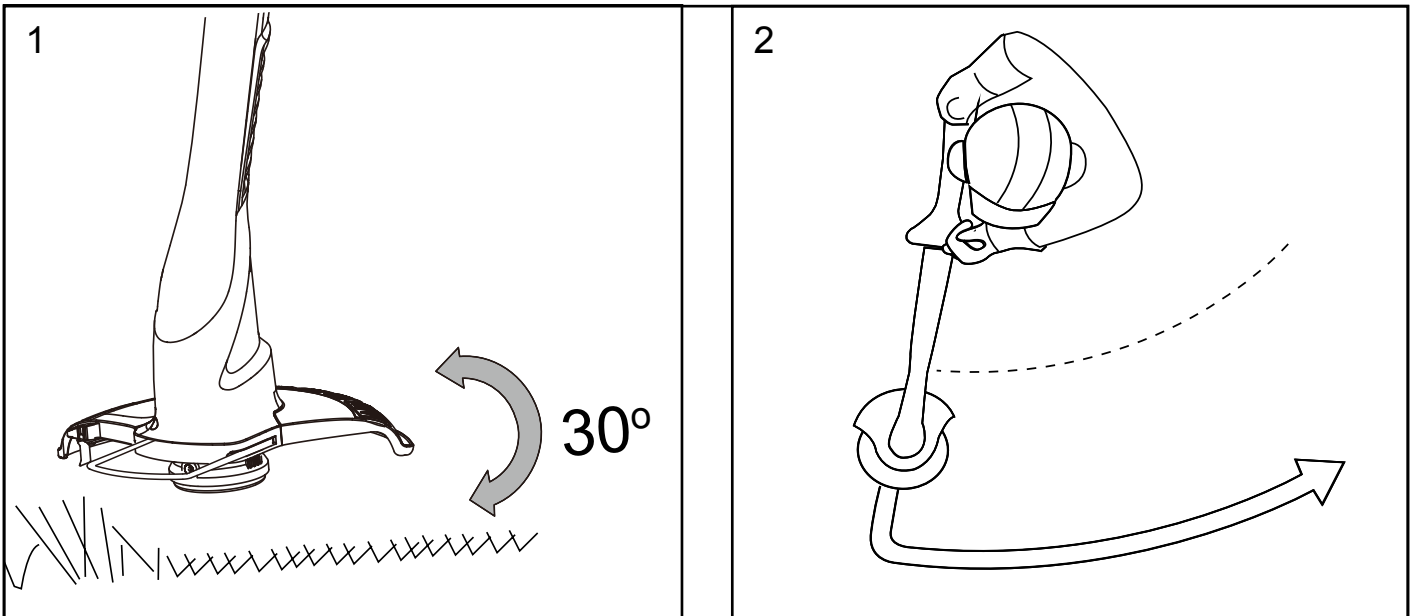

- Ensure the protective covering is removed from the line cutting blade protection before use. Ensure you wear gloves when removing this covering.
- Hold the grass trimmer firmly, keeping your balance with feet slightly apart.
- Hold the trimmer head just above the ground at an angle of approximately 30°.
- Move the product slowly from side to side in a swinging motion.
- Ensure the trimmer head remains clean and free from debris that may cause it to jam.

Warning!

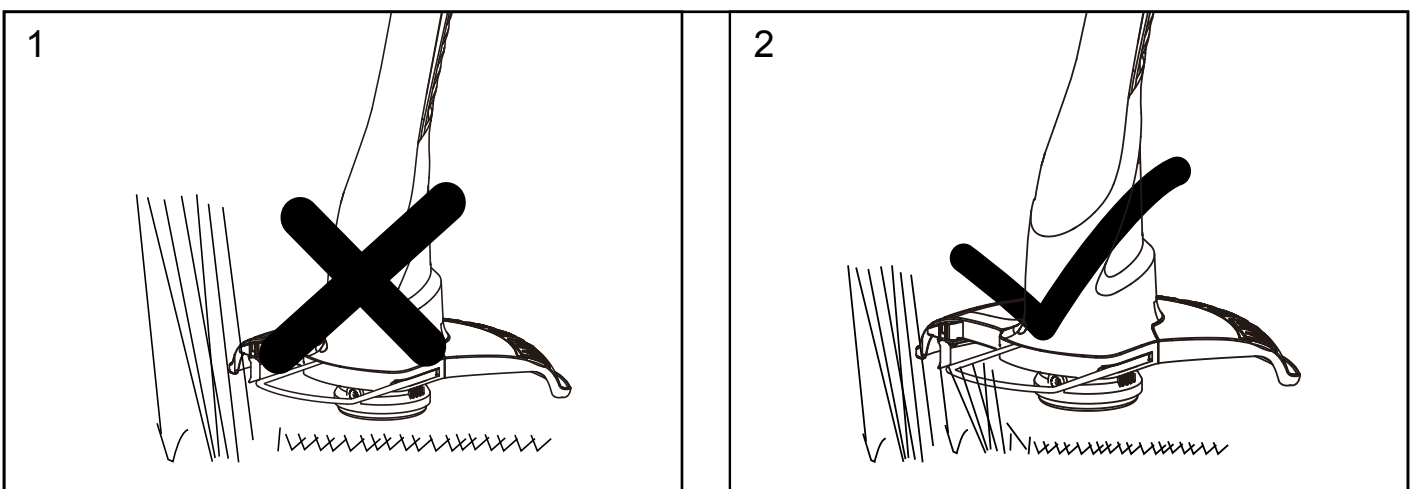

- Always fit the guard before using the product.
- When cutting longer or high grass, cut this down in 2 to 3 stages.
- DO NOT cut long grass in one cut, as this will damage your grass trimmer, and make your warranty invalid.

Operation

Tips

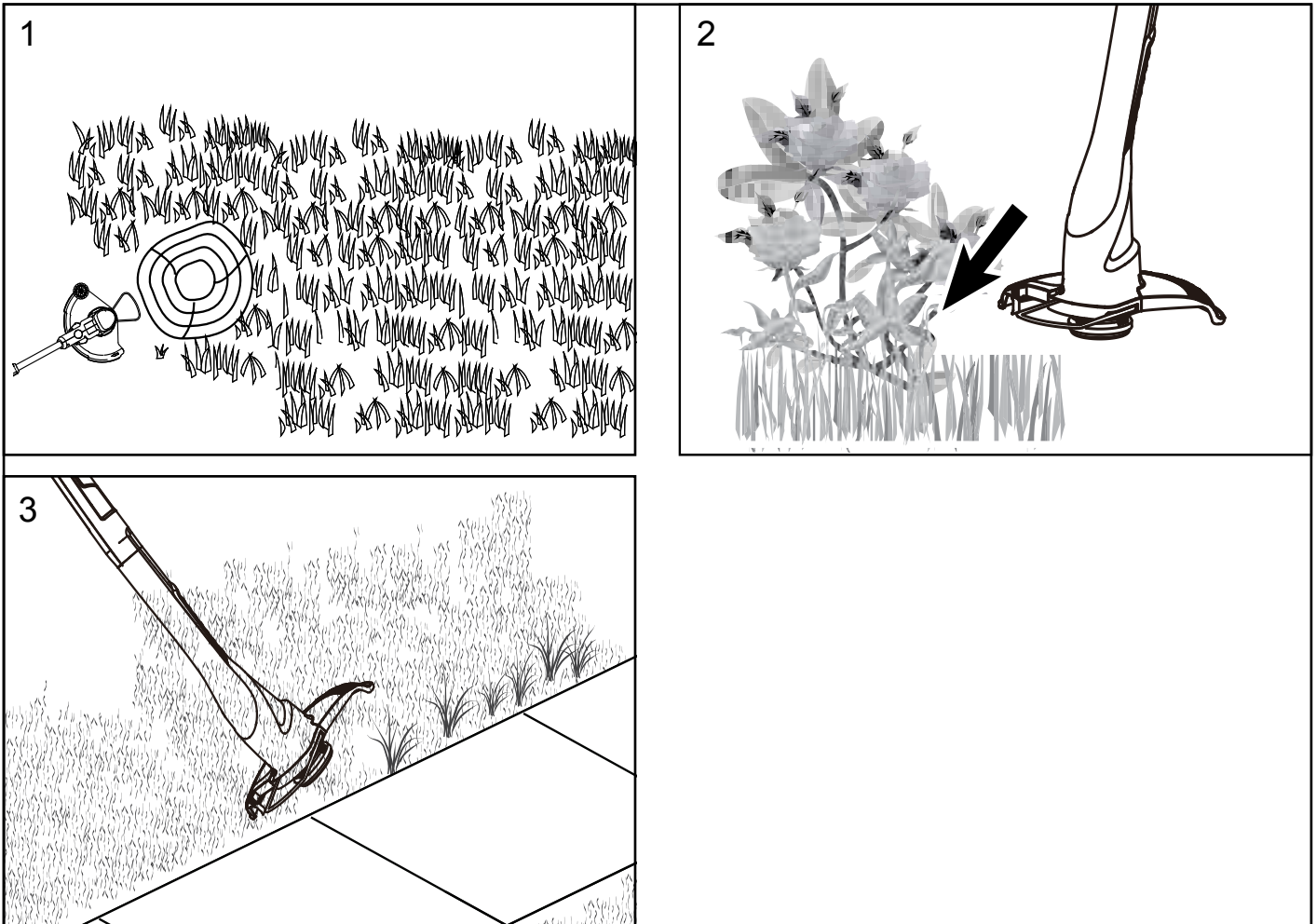

- For best results, do not cut wet grass because it tends to stick to the trimmer head and guard, prevents proper discharge of grass trimmings, and could cause you to slip and fall.
- Do not allow the spool cover to drag on the ground or other surfaces.
- Pay special attention when performing the work close to trees and bushes. The cutting line could damage sensitive bark, and damage fence posts.
- Regularly remove clippings and dirt from around the spool and guard. Ensure the product is switched off.
- Do not move the product too fast as this will result in ineffective cutting and possible damage.
- Carefully manoeuvre the product around objects, such as trees and bushes, ensuring it does not come into contact with them. Use the plant guard to ensure that the cutting line does not come into contact with sensitive plants.
- Use the plant guard to avoid bringing the cutting line into contact with hard objects such as walls and curbs which will excessively wear the line.
- Wait until the product has come to a complete stop before placing it down.

NOTE: The cutting line will wear faster if the cutting is done along pathways or other abrasive surfaces or for tackling heavier weeds.

NOTE:

Wear suitable personal protective equipment (PPE), such as a dust mask, when using the machine.

Maintenance

Replacing the spool

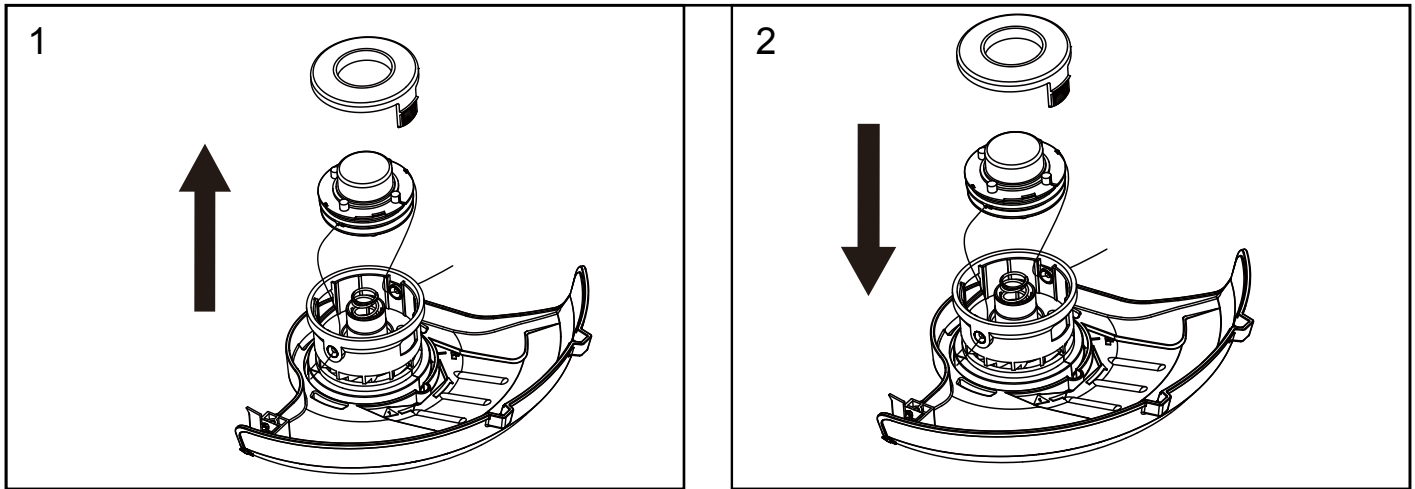

NOTE: Before replacing the spool, make sure the mains plug is disconnected from the unit.

- Press together both locking device tabs on the spool cover and remove the cover.
- Remove the old spool from the spool housing.
- Clean out any dirt or grass residue.
- Put the new spool in the spool housing, thread the line into the guide holes.

Winding the line

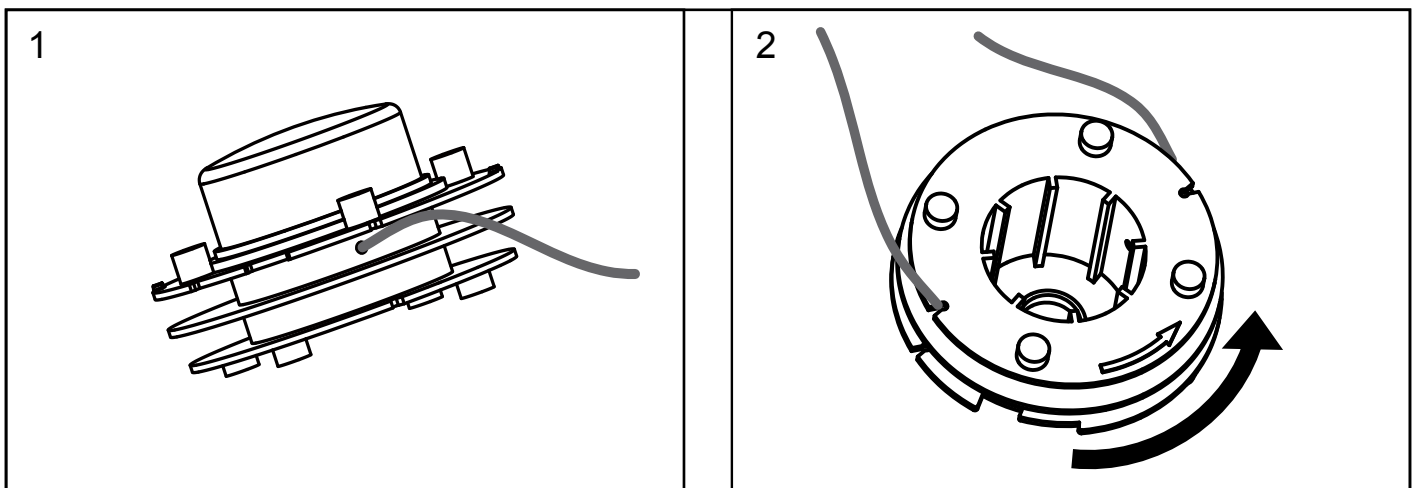

NOTE: Self-winding is not recommended. If the line is not wound properly it can cause the trimmer feed system to malfunction. For this reason, users are strongly urged to purchase the pre-wound spool.

Maintenance

Winding the line (continued)

Should you wish to wind the line yourself, the instructions are provided below:

- Cut 2 cutting lines with the same length for winding, approximately 3 m long for each. Use only 1.2 mm diameter monofilament line.
- Insert the cutting lines into each of the two anchor holes. One anchor hole is in the inside upper section of the spool as shown, and the other is in the opposite lower section of the spool.
- Wind the lines following the directional arrow on the spool housing and hook the two ends into the side grooves. Make sure to wind the line on neatly and in layers. Do not criss-cross.

Storage

- Store the product and its accessories in a dry, frost-free place.
- Always store the product in a place that is inaccessible to children. The ideal storage temperature is between 10°C and 30°C.

Transportation

- Switch the product off and disconnect the plug before transporting it anywhere.
- Protect the product against scratching and secure it to avoid damage from impact.

After use

- Switch the product off, take off the plug and let it cool down.
- Check, clean and store the product as described above.

Recycling and disposal



- The product comes in a package that protects it against damage during shipping. Keep the packaging until you are sure that all parts have been delivered and the product is functioning properly. Recycle the packaging afterwards.
- Old products are potentially recyclable and do not, therefore, belong in your household rubbish. You are requested to assist us and our contribution to saving resources and protecting the environment by handing in this product at an equipped collection centre (if there is one available).

Technical Data

Technical Data Table

Model	MCEGT3223
Rated voltage	220-240V~ 50Hz
Rated power	320W
Motor speed	12000/min
Cutting width	23cm
Cutting line dia.	1.2mm
Line feed type	Bump
Cable Length	6m
Line Length	5m*2
Measured sound pressure level (L_{pA})	86dB(A)
Measured sound power level (L_{WA})	93.2dB(A), K=2.2dB(A)
Guaranteed sound power level (L_{WA})	96dB(A)
Vibration at the rear handle (a_p)	4.3m/s ² K=1.5m/s ²
Net weight	2kg
Insulation class	II/ 

Part List

PART NUMBER	ACCESSORIES
121092104	Spool

Technical Data

Part List (continued)

Measured sound pressure level L_{PA} : 86dB(A), K=3dB(A)

Measured sound power level L_{WA} : 93.2dB(A), K=2.2dB(A)

Guaranteed sound power level L_{WA} : 96dB(A)

The sound values have been determined according to noise test code given in EN50636-2-91, using the basic standards EN ISO 11201 and EN ISO 3744.

The sound intensity level for the operator may exceed 80dB(A) and ear protection measures are necessary.

The declared vibration value has been measured in accordance with a standard test method (according to EN 50636-2-91) and may be used for comparing one product with another. The declared vibration value may also be used in a preliminary assessment of exposure.

WARNING! Depending on the actual use of the product the vibration values can differ from the declared total! Adopt proper measures to protect yourself against vibration exposures! Take the whole work process including times the product is running under no load or switched off into consideration!

Proper measures include, among others, regular maintenance and care of the product and cutting attachments, keeping hands warm, periodical breaks and proper planning of work processes!

Troubleshooting

General Troubleshooting

Suspected malfunctions are often due to causes that the user can fix themselves. Therefore, check the product using this section. In most cases the problem can be solved quickly.



WARNING!

Only perform the steps described within these instructions! All further inspection, maintenance and repair work must be performed by a qualified specialist if you cannot solve the problem yourself!

Gloves and appropriate protective clothing must be worn when performing these operations. When inspecting the machine always unplug the machine from the power outlet.

Problem	Possible Cause	Solution
Trimmer does not start.	Not connected to power supply.	Connect to power supply.
	Power cord or plug is defective.	Check by a qualified person or contact the after sales helpline.
	Other electrical defect to the product.	Check by a qualified person or contact the after sales helpline.
Trimmer does not reach full power.	Power source (e.g., generator) has too low voltage.	Connect to another power source.
	Air vents are blocked.	Clean the air vents.
Unsatisfactory cutting performance.	Cutting line spool worn or empty.	Replace cutting line spool or rewind new nylon cutting line on to spool.

Getting Help

After Sales Support

Our dedicated UK based customer helpline is open to assist you with assembly, parts queries and technical support. We are open during office hours. Our experts are here to get you back enjoying your garden in no time. Calling our service does not affect your statutory rights.

After sales helpline number: 0345 605 2063

Guarantee

Dear Customer,

In the unlikely event that your device develops a fault, please contact our Customer service department on the telephone number shown below.

1. These guarantee terms cover additional guarantee rights and do not affect your statutory warranty rights. Claims must be accompanied by Proof of Purchase. This must be in the form of a Sales receipt or Bank statement and must show that the product has been purchased within 2 years prior to the claim, from the retailer that it was originally sold to.
2. Our guarantee covers problems caused by material or manufacturing defects. Please note that our devices have not been designed for use in commercial, trade or industrial applications. Consequently, the guarantee is invalidated if the equipment is used in commercial, trade or industrial applications or for other equivalent activities.
3. The following are also excluded from our guarantee :
 - A. Faults due to accidents, customer misuse or unauthorized repairs
 - B. Failure due to lack of routine maintenance.
 - C. Failure as a result of not using the equipment in accordance with the manual and safety instructions.
 - D. Accidental damage or wear to cables or blade.
4. The guarantee is valid for a period of 2 years starting from the purchase date of the device. Guarantee claims should be submitted before the end of the guarantee period within two weeks of the defect being noticed. No guarantee claims will be accepted after the end of the guarantee period. The original guarantee period remains applicable to the device even if repairs are carried out or parts are replaced. In such cases, the work performed or parts fitted will not result in an extension of the guarantee period, and no new guarantee will become active for the work performed or parts fitted.
5. Please keep your sales receipt in a safe place.

