

145.00 mm

**BUSH**

Instruction manual  
V8715



210.00 mm



You'll soon be enjoying your new handheld vacuum cleaner

It all begins here, with your instructions. Don't worry, there's nothing too technical coming up. Just simple, step-by-step guidance to get you up and running quickly. Sound good? Then let's get started.

## Help and Guidance

We're here to help you get the most from your vacuum cleaner. Should you require any guidance, a simple solution can often be found online at:

[www.argos-support.co.uk](http://www.argos-support.co.uk)

**If you still require further assistance, call one of our experts on TMTI HELPLINE 0345 604 0105 .**

# Contents

## 1 Safety information

Safety information	6
Electrical requirement	7

## 2 Getting to know your handheld vacuum cleaner

Illustration	11
Features	11
Power controls	12
Charge	12

## 3 Using your handheld vacuum cleaner

Using the handheld vacuum cleaner	14
Assembly the charger to the wall	15

## 4 Care and maintenance

Care for the handheld vacuum cleaner	18
Cleaning the handheld vacuum cleaner	18
Technical specification	20

## 5 Product support

Troubleshooting	22
Help and assistance	23
Declaration of conformance to product	24
Standards	
Disposal	26



# Safety information 1



## Safety information

### Important safety instructions

The use of any electrical appliance requires the following common sense safety rules.

Primarily there is danger of injury or death and secondly the danger of damage to the appliance. These are indicated in the text by the following two conventions:

#### **Warning: Danger to the person!**

IMPORTANT: Damage to the appliance! In addition we offer the following safety advice.

#### **Location**

- Do not use or keep this product outside when it is raining.
- Do not store the appliance near hot ovens or heating appliances.

#### **Mains lead**

- Do not allow the mains lead to become strained or run this appliance over it.
- If the electrical cable becomes damaged, the complete cable assembly must be replaced. Do not attempt this task yourself. Contact the local retailers.

#### **Children**

- Do not leave the children use the product alone.
- The product should be stored somewhere children can't reach

#### **Personal safety**

- Never modify the cleaner in any way.
- Never use in the presence of explosive liquids or vapors.
- Never pick up inflammable or poisonous liquids such as petrol, copier toner or other volatile substances. Never pick up acids, asbestos or asbestos dust.
- Repairs to electrical appliances are only to be undertaken by trained personnel.

Unprofessional repairs can be dangerous for users.

- The appliance must never be left running when unsupervised.

If you require any technical guidance or find that your product is not operating as intended, a simple solution can often be found in the **Troubleshooting** section of these instructions.

## Product safety

- Never use the appliance without the filters being installed.
- Never use the appliance to clean hot ashes, broken glass, sharp things and harmful liquids.
- To protect against fire, electric shock and personal injury do not immerse cord, plug or cleaner in water or other liquid.

## Electrical requirements

Check that the voltage on the rating plate corresponds with your house electricity supply which must be A.C (alternating current)

If the socket outlets in your home are not suitable for the plug supplied with this appliance the plug should be removed and the appropriate one fitted.

You must keep in mind that this product can not be used while it is charging, vice versa.

This appliance is intended for domestic household use only and should not be used for any other purpose or in any other application, such as for non-domestic use or in a commercial environment.

This appliance can be used by children aged from 8 years and above and persons with reduced physical, sensory or mental capabilities or lack of experience and knowledge if they have been given supervision or instruction concerning use of the appliance in a safe way and understand the hazards involved. Children shall not play with the appliance. Cleaning and user maintenance shall not be made by children without supervision.





Getting to know your vacuum cleaner

2

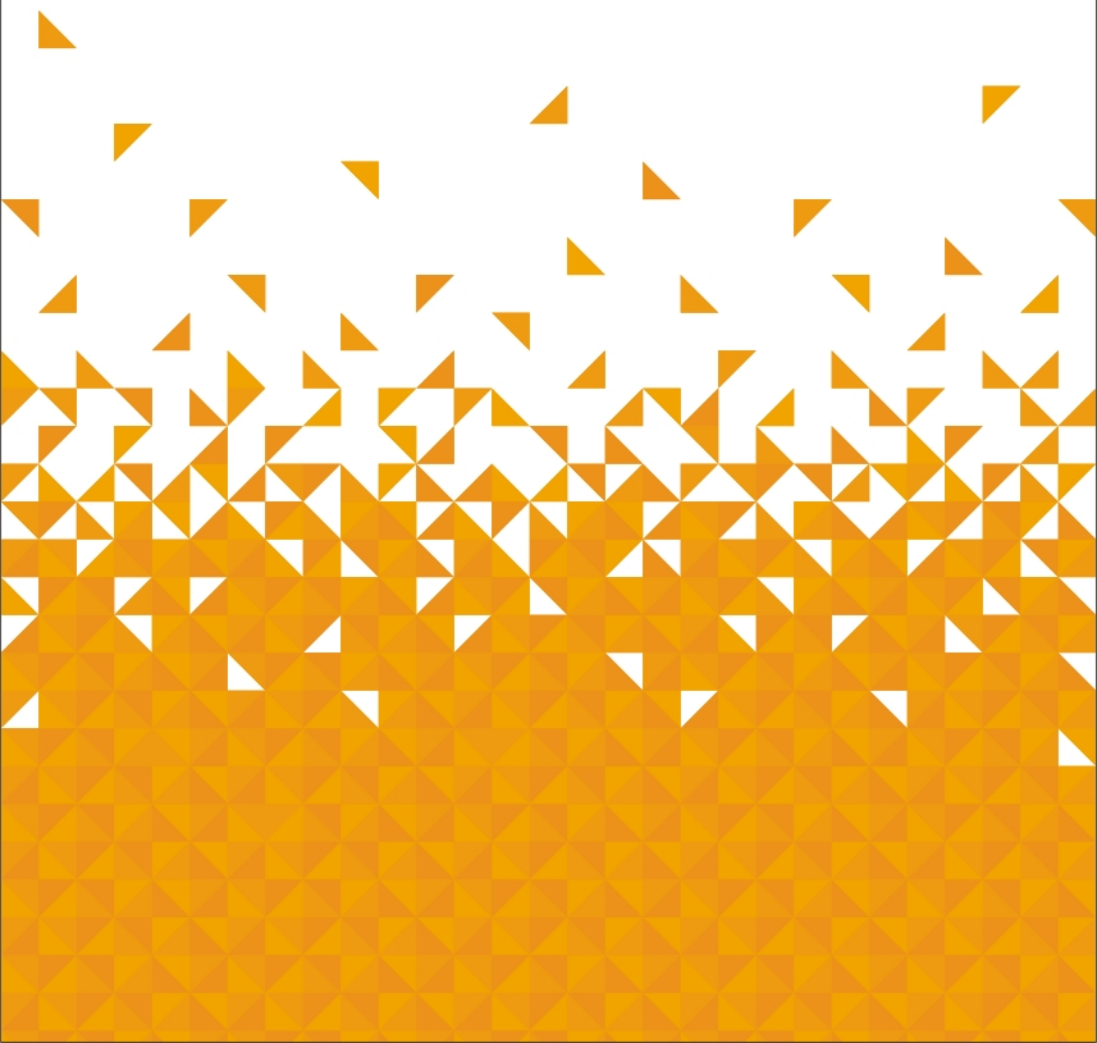

## Getting to know your vacuum cleaner

You'll be up and running in no time

### Ready? Let's begin...

Please read these instructions carefully. They contain important information which will help you get the best from your Vacuum cleaner and ensure safe and correct installation and operation.

If you require any further assistance, our technical experts are happy to help. For full details, refer to the product support section at the end of these instructions.

If you require any technical guidance or find that your product is not operating as intended, a simple solution can often be found in the **Troubleshooting** section of these instructions.

# Getting to know your Vacuum cleaner

You'll be up and running in no time

## ILLUSTRATION

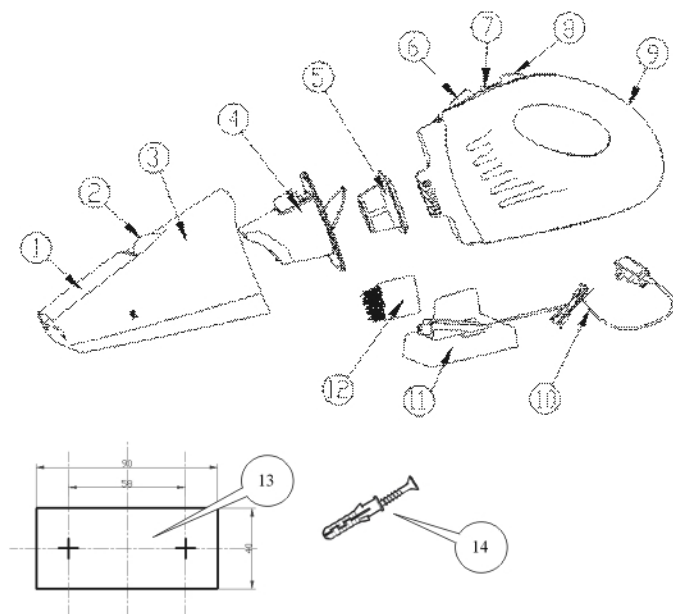

### Features

- |                   |                        |
|-------------------|------------------------|
| 1.Sucker          | 8.On/off switch-button |
| 2.Sucker button   | 9.Main body            |
| 3.Dust cup        | 10.Charger             |
| 4.Small dust cup  | 11.Charger assembly    |
| 5.filter          | 12.Assembly brush      |
| 6.Dust cup button | 13.Adhesive guide      |
| 7.Light indicator | 14.Screws with anchors |

or online at [www.argos-support.co.uk](http://www.argos-support.co.uk) if you still require further assistance, call one of our experts on 0345 604 0105 .

## Power controls

The on/off control is operated by On/off switch-button8. (Fig.1)

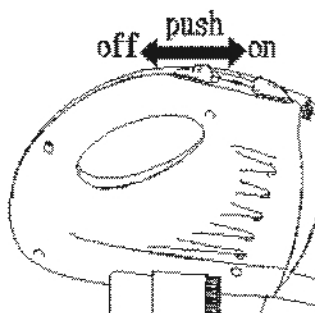

Fig.1

## How to charge the appliance

- Insert the appliance in the charger with the opening facing upward and connect to the socket. (Fig.2)

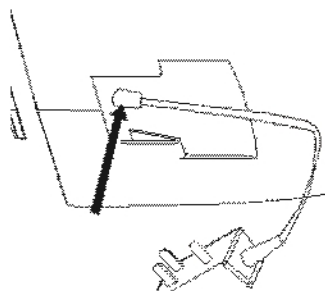

Fig.2

- Put the charger into an earthed 230V~50HZ mains socket, the light indicator 7 around the switch-buttons will turn red.
- The light indicator 7 will turn green when the charging is completed. It will take about 13-16 hours.

**WARNING:** You can leave the vacuum cleaner being charged the appliance will heat up slightly, but this is absolutely safe. However, if you do not use the product for long time, we recommend that you remove it from the charging.

If you require any technical guidance or find that your product is not operating as intended, a simple solution can often be found in the **Troubleshooting** section of these instructions.

Using your vacuum cleaner

3



## Using your handheld vacuum cleaner

Getting the most from your appliance

### First use of handheld vacuum cleaner

### Using your vacuum cleaner

- The appliance as you find it in the package is made to vacuum dust or solid materials from broad surfaces.
- For vacuuming dust and solid materials in narrow spaces, use vacuuming sucker 1.
- To vacuum Assembly brush12 , use vacuuming accessory ( fig.3)

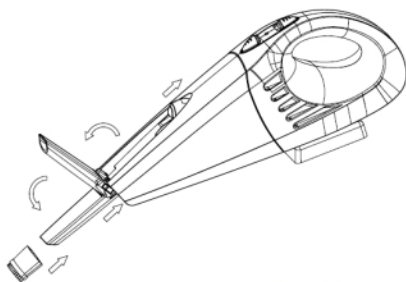

Fig.3

- Once the dust or water has reached the maximum capacity level, empty the dust cup.
- Never tilt the appliance upwards so as to avoid spilling the water.
- Always empty the dust cup and dry the filter after each use.

**WARNING:** Do not vacuum substances or products that are hot (embers, cigarettes, matches), toxic(solvents) , flammable or explosive (petrol , alcohol) , sharp (glass)or corrosive (acids) or liquids(but water is excepted).

If you have vacuumed liquids, always empty the tank and dry the filter before placing the appliance in the battery charger base .

## How to mount the charger assembly to the wall

- Choose where you wish to position the charger assembly.
- Make sure that the length of the cord is enough to reach the outlet.
- Wind any excess cord around the charger assembly. Pass the cord through the groove. (fig.4)
- Apply the adhesive guide to the wall and, with a 5mm-diameter wall drill, make the holes marked on the adhesive.(fig.5)
- Insert the anchors in the wall and secure the charger assembly with the screws.

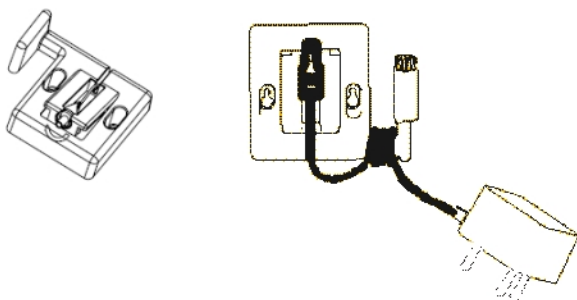

Fig.4

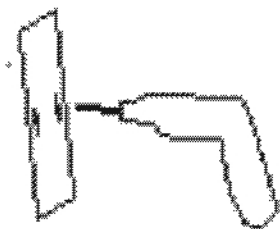

Fig5





# Care and maintenance

# 4

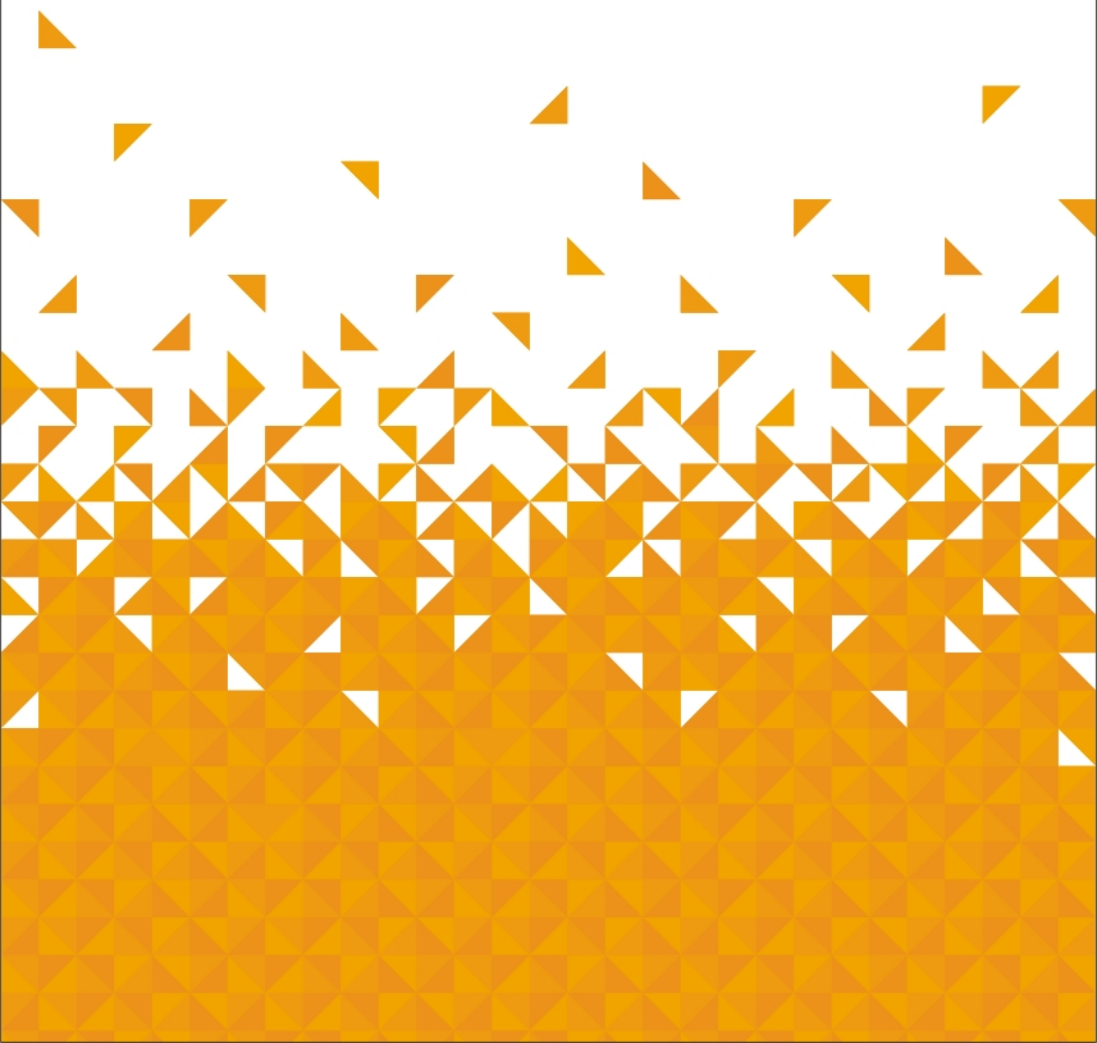

## How to care for the Vacuum Cleaner

- Always disconnect the appliance before performing maintenance.
- Remember that frequent maintenance improves the functional performance of the appliance.

## How to care for the Vacuum Cleaner

- Always disconnect the appliance before performing maintenance.
- Remember that frequent maintenance improves the functional performance of the appliance.

## How to clean the dust cup and filter

- Press the dust cup button located on top of the appliance and remove the dust cup (fig.6)

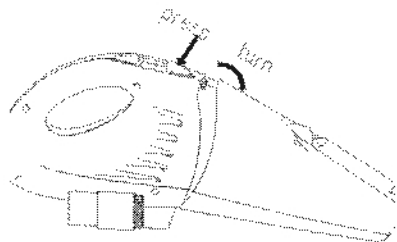
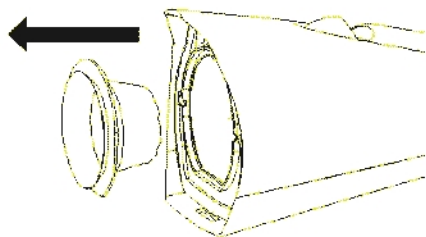

Fig.6

- Empty the dust cup and wash it with water and a detergent that does not contain abrasive substances. Carefully dry them with a soft cloth.
- Remove the filter. fig.7



(Fig.7)

- Remove the Small dust cup. fig.8

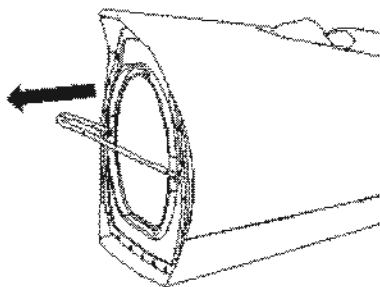

(Fig.8)

- Wash the filter with water and a detergent that does not contain abrasive substances. Dry the filter completely before repositioning it.
- Insert the holder in the dust cup3 and filter5 in the holder.
- Reposition the dust cup3 by placing it in the groove and pressing it , until you hear the "click".

## Technical Specifications

Model Number	V8715
Charge voltage	220-240V~50/60Hz
Battery	12V NiMH SC1300 mAh
Capacity	400mL
Running time	12mins
Suction power	70W
Cable length	180cm
Noise function	80dB(A)
Rated input power	Wet & Dry

If you require any technical guidance or find that your product is not operating as intended, a simple solution can often be found in the **Troubleshooting** section of these instructions.

# Product support 5



## Product support

Help is always at hand

### TROUBLESHOOTING

Please check the following details before you have your appliance repaired by an authorised servicing agent.

1. Vacuum cleaner does not work.

You can check if the battery of the product has been run out. Pls double check if the power switch of the appliance is on.

2. Suction power becomes weak.

You can check if the product has a low battery power. Or check if the dust cup is full or check if the filter sponge is clogged.

The possible solution is to immediately charging the product, remove the obstruction, or empty the dust cup or clean the filter.

3. Vacuum cleaner is overheating

You can check if the filter is blocked. The possible solution is to clean the filter.

4. Dust is coming out of the vacuum cleaner

You can check if the dust container is properly fitted to the cleaner. The possible solution is to refit the dust container to the cleaner.

# Product support

Help is always at hand

## Help and assistance

If you require any technical guidance or find that your wash vacuum cleaner is not operating as intended, a simple solution can often be found in the **Troubleshooting** section of these instructions or online at

[www.argos-support.co.uk](http://www.argos-support.co.uk)

If you still require further assistance, call one of our experts on **0345 604 0105**. To help give us give you a fast and efficient service please have the following information ready:

Model Ref.

You can find these on the rating plate - a small information panel (usually a sticker or metal plate) on the rear of your appliance

Serial number

Date of purchase

This will be shown on your receipt

Local call rates applies\*

Lines open 8am-7pm Monday to Saturday and 10am-4pm Sunday.

\*Calls to Argos enquiry lines may attract a charge and set up fee from residential lines depending on your call plan/tarif. Mobile and other providers costs may vary, see [www.bt.com/pricing](http://www.bt.com/pricing) for details.

For Security and training purposes, telephone calls to and from customer service centres maybe recorded and monitored. Calls from Republic of Ireland will attract international call charges.

## Product support

Help is always at hand



This appliance complies with the following CE directives:  
2014/35/EU low voltage directive  
2014/30/EU the EMC directive  
2011/65/EU the ROHS directive



This is a class II appliance.

### Notes on disposal:



This marking indicates that this product should not be disposed with other household wastes throughout the EU. To prevent possible harm to the environment or human health from uncontrolled waste disposal, recycle it responsibly to promote the sustainable reuse of material resources. To return your used device, please use the collection systems or contact the retailer where the product was purchased. They return and can take this product for environmental safe recycling.

If you require any technical guidance or find that your product is not operating as intended, a simple solution can often be found in the **Troubleshooting** section of these instructions.



## Battery



If you want to dispose of the product yourself, the battery must be removed as described below and disposed of in accordance with local regulations.

- Preferably discharge the battery by operating the appliance until the motor stops.
- Press the dirt cup release button and remove the dust container.
- Remove the five screws holding the body of the appliance together.
- Lift the housing cover away from the assembly.
- Detach all lead connections from the battery pack.
- Remove battery pack and motor assembly.
- Place the battery pack and motor assembly in suitable packaging to ensure that the terminal cannot be short-circuited.
- Take the battery pack and motor assembly to your service agent or to a local recycling station. Once removed, the battery cannot be refitted.

## Product support

Help is always at hand

# BUSH

Call us now and activate your 12 month guarantee

Thank you for choosing Bush. Your new product is guaranteed against faults and breakdowns for 12 months. Don't forget to register it with us today so we can provide you with our best possible after-sales service and useful updates.

[www.bushregistration.co.uk](http://www.bushregistration.co.uk)

FREEPHONE\*

0800 597 8548

Lines are open 8am - 8pm, 365 days a year. \*Calls may be recorded and monitored.

### Your Bush Guarantee

This product is guaranteed for twelve months from the date of original purchase. Any defect that arises due to faulty materials or workmanship will be repaired free of charge (or if applicable the product will be replaced or the purchase price refunded) where possible during this period by the dealer from who you purchased the unit.

The guarantee is subject to the following provisions:

- The guarantee does not cover accidental damage, misuse, cabinet parts, knobs or consumable items.
- The product must be correctly installed and operated in accordance with the instructions contained in the manual.
- It must be used solely for domestic purposes. The guarantee will be rendered invalid if the product is re-sold or has been damaged by inexpert repair.
- Specifications are subject to change without notice.
- Bush disclaim any liability for loss or damage arising from the breakdown of the product.
- This guarantee is in addition to and does not diminish your statutory or legal rights.

### Important Data Protection Information

If you provide us with information about another person, you confirm that they have appointed you to act for them, to consent to the processing of their personal data including sensitive personal data and that you have informed them of our identity and the purposes (as set out in the Important Data Privacy notice displayed overleaf) for which their personal data will be processed.

You are entitled to ask for a copy of the information we hold about you (for which we may charge a small fee) and to have any inaccuracies in your information corrected.

For quality control and training purposes, we may monitor or record your communications with us.

If your personal details change, if you change your mind about any of your marketing preferences or if you have any queries about how we use your information, please let us know by contacting our Data Protection Officer, Domestic & General, Leicester House 17 Leicester Street, Bedworth, Warwickshire CV12 8JP.

Guarantor: Argos Limited - 489 - 499 Avebury Blvd. - Milton Keynes - MK9 2NW

If you require any technical guidance or find that your product is not operating as intended, a simple solution can often be found in the **Troubleshooting** section of these instructions.



# BUSH

## Contact:

[www.argos-support.co.uk](http://www.argos-support.co.uk)

Helpline: 0345 604 0105