

BUSH

Instruction manual

Washing Machine

WMDF814B

WMDF814W





You'll soon be enjoying your new washing machine.

It all begins here, with your instructions. Don't worry, there's nothing too technical coming up. Just simple, step-by-step guidance to get you up and running quickly. Sound good? Then let's get started.

Help and Guidance

We're here to help you get the most from your <washing machine>. Should you require any guidance, a simple solution can often be found online at:

www.argos-support.co.uk

If you still require further assistance, call one of our experts on **0345 257 7271**.

If you require any technical guidance or find that your product is not operating as intended, a simple solution can often be found in the **Troubleshooting** section of these instructions, or online at **www.argos-support.co.uk** If you still require further assistance, call one of our experts on **0345 257 7271**.

Contents

1 Safety information

Safety information 6

2 Getting to know your washing machine

Ready? Let's begin 10

Accessories 12

3 Installing your washing machine

Installation requirements 14

Unpacking 14

Connections (electrical, water, gas) 15

4 Functions

Functions 18

5 Using your washing machine

First use of <washing machine> 24

Standard and advanced functions/use 25

6 Care and Maintenance

Cleaning 28

Maintenance actions 28

Technical specifications 29

7 Product support

Troubleshooting 32-33

Error Signals 34

Technical Specifications 35

Help and assistance 36

Disposal 37

Guarantee 38



Safety information

1





Safety information

Important - Please read these instructions fully before installing or operating your washing machine

Before use

- If the supply cord is damaged, it must be replaced by the manufacturer, their service agent or similarly qualified persons in order to avoid a hazard.
- The new hose-set supplied with the appliance are to be used and that old hose-set should not be reused.
 - This appliance can be used by children aged 8 years and above and persons with reduced physical, sensory or mental capabilities or lack of experience and knowledge if they have been given supervision or instruction concerning use of the appliance in a safe way and understand the hazards involved. Children shall not play with the appliance. Cleaning and user maintenance shall not be done by children without supervision.
 - Children should be supervised to ensure that they do not play with the appliance.
 - Pull out its plug from the power socket before cleaning or maintenance.
 - Make sure that all pockets are emptied.
 - Pull out its plug and cut off water supply after the operation.
 - Pets and children may climb into the machine. Check the machine before every operation.
 - Glass door may be very hot during the operation. Keep children and pets far away from the machine during the operation.
 - Take care that power voltage and frequency shall be identical to those of washing machine.
 - Do not use any socket with rated current less than that of washing machine. Never pull out the power plug with wet hands.
 - To ensure your safety, the power cord plug must be inserted into an earthed three-pole socket. Check carefully and make sure that your socket is properly and reliably earthed.
 - Packing materials may be dangerous to the children. Please keep all packing materials (plastic bags, foams etc) far away from the children.
- The installation of this appliance is best carried out by 2 people.
- Dispose of all packaging carefully and responsibly.
- This appliance is for indoor use only. Only install in a dry indoor environment.
- The appliance **MUST** be positioned on a firm level base.
- Do not position the appliance where it is exposed to direct sunlight or heat sources as this will age the plastic and rubber components.
- Ensure all 4 packing bolts have been removed.
- Ensure the appliance is connected directly to a domestic mains water supply.
- Warning: This washing machine **MUST** only be connected to a cold water supply.
- Ensure all electrical connections are as stated in this document.
- Ensure the appliance is plugged into a separate earthed socket that is easily accessible.
- Ensure the power lead is not trapped under the appliance.
- Do not connect the appliance to the power supply until installation is complete.
- This appliance is for domestic/household use only and is not suitable for commercial use.
- Check that the water hose joints and connections are secure and there are no leaks. If the hoses leak, do not use them until the leaks have been stopped.
- Do not forget that the packing material of your machine may be hazardous for children.

If you require any technical guidance or find that your product is not operating as intended, a simple solution can often be found in the **Troubleshooting** section of these instructions, or online at www.argos-support.co.uk If you still require further assistance, call one of our experts on **0345 257 7271**.



Safety information

Important - Please read these instructions fully before installing or operating your washing machine

During use

or the Customer Helpline: 0345 257 7271.

- Do not use a multiple socket or extension cord.
- Do not use if the power lead is damaged. It must be replaced by the manufacturer, their approved service agent or similarly qualified person. Customer Helpline: 0345 257 7271.
- Do not insert the plug into the power supply with wet hands.
- Do not touch or use the appliance when barefoot or with wet or damp hands.
- Do not open the detergent drawer during a wash cycle.
- Do not touch the porthole (door) during the washing cycle - it will get hot.
- Never force the machine door open while the machine is running.
- Do not open the door if water is visible through the porthole.
- Do not wash foam rubber or sponge like materials on a hot wash.
- The machine can reach high temperatures while running. Do not touch the drain hose or waste water during draining.
- Keep your pet away from your machine.
- Do not use flammable detergent, sprays or dry cleaning agents in or near to the appliance.
- Do not remove or insert the plug in the presence of flammable gas.
- The appliance should not be put on a carpet which can block the air ventilation on the bottom side.
- Do not place heavy objects or sources of heat or damp on top of the washing machine.
- Only use detergents which are suitable for automatic washing machines and follow the detergent manufacturers recommendations.
- Do not use this appliance if there are any missing or damaged parts.
- Do not attempt to repair the appliance yourself. Contact the manufacturer, their approved service agent

If you require any technical guidance or find that your product is not operating as intended, a simple solution can often be found in the **Troubleshooting** section of these instructions, or online at www.argos-support.co.uk If you still require further assistance, call one of our experts on **0345 257 7271**.



Getting to know your washing machine

2



Getting to know your washing machine

You'll be up and running in no time

Ready? Let's begin...

Please read these instructions carefully. They contain important information which will help you get the best from your washing machine and ensure safe and correct installation and operation.

If you require any further assistance, our technical experts are happy to help. For full details, refer to the product support section at the end of these instructions.

If you require any technical guidance or find that your product is not operating as intended, a simple solution can often be found in the **Troubleshooting** section of these instructions, or online at www.argos-support.co.uk If you still require further assistance, call one of our experts on **0345 257 7271**.

Getting to know your washing machine

You'll be up and running in no time

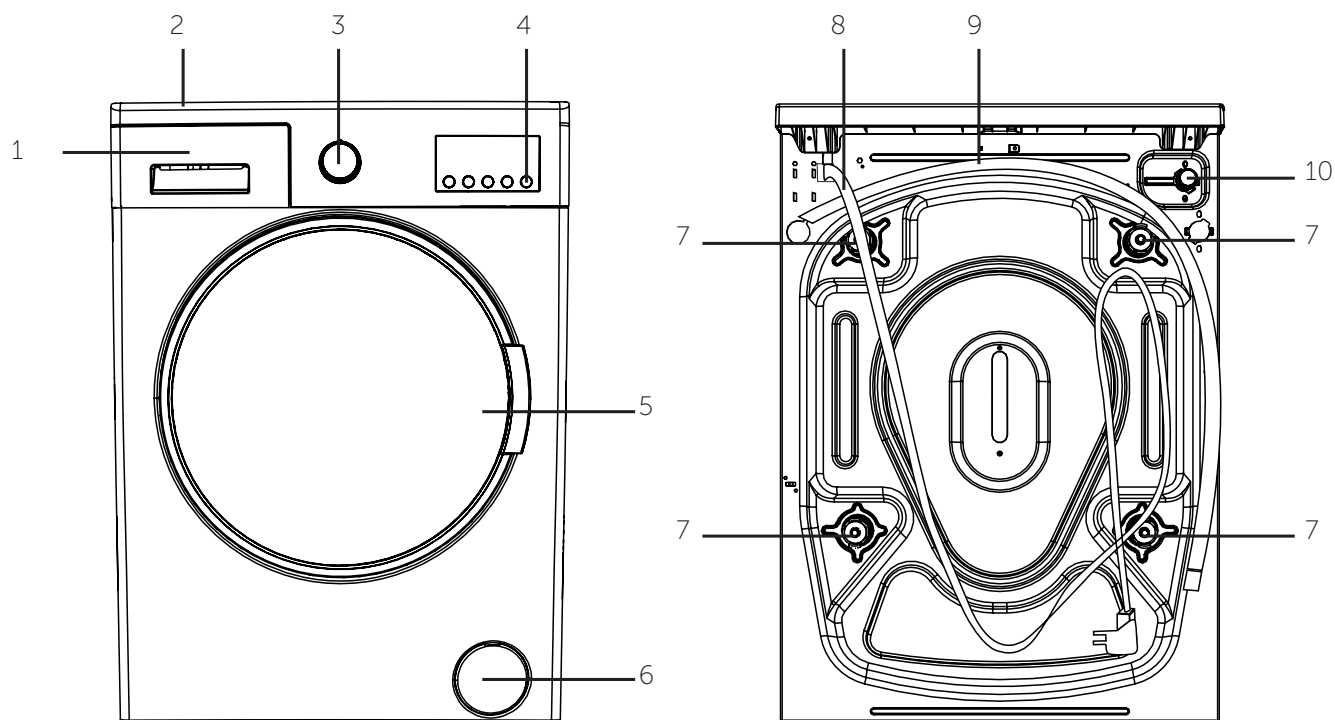

Front

1. Detergent drawer
2. Top panel
3. Programme knob
4. Start/Pause button
5. Door
6. Filter

Back

7. Packing bolt x 4
8. Power lead
9. Drain hose
10. Water inlet

If you require any technical guidance or find that your product is not operating as intended, a simple solution can often be found in the **Troubleshooting** section of these instructions, or online at www.argos-support.co.uk. If you still require further assistance, call one of our experts on **0345 257 7271**.

Getting to know your washing machine

You'll be up and running in no time

Model	Capacity	Spin Speed	Energy class
WMDF814B	8kg	1400rpm	A++
WMDF814W	8kg	1400rpm	A++

Accessories

This machine includes the below accessories, please install these parts before operating.

- plastic hole plug x 4
- Inlet hose

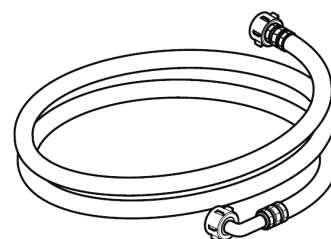
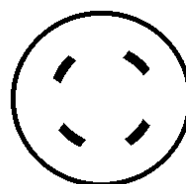

If you require any technical guidance or find that your product is not operating as intended, a simple solution can often be found in the **Troubleshooting** section of these instructions, or online at www.argos-support.co.uk If you still require further assistance, call one of our experts on **0345 257 7271**.

Installing your washing machine

3



Installing your washing machine

Bringing it all together

Unpacking your washing machine

Caution: 2 people are required to unpack the washing machine, it is recommended that gloves are worn.

a: Carefully remove all packaging materials including the foam base, dispose of correctly.

Note: When opened, water droplets may be visible in the drum etc. this is normal as each appliance is factory tested.

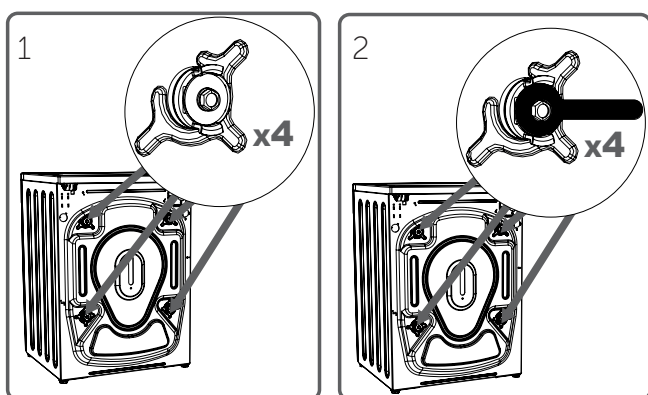

Removing the packing bolts

Important: The packing bolts are designed to support the internal components during transit, these MUST be removed before use.

a: Loosen the screws by rotating counter clockwise with a suitable wrench. (1 & 2)

b: Remove the bolts by pulling them. (3)

c: When the transport bolts have been removed, insert the plastic transport screw taps found in the accessories bag into the holes. (4)

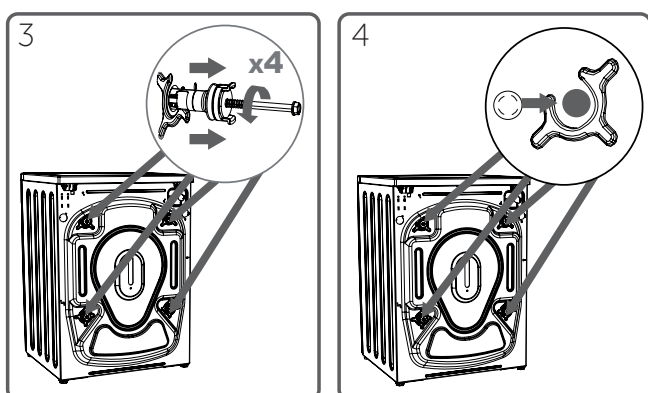

Adjusting the feet

a: For your machine to work efficiently with minimum vibration it should be settled on flat, non-slippery, firm ground.

b: You can adjust the balance of your machine by changing the positioning of its feet.

c: First, loosen the plastic adjustment nut. (5)

d: Adjust by rotating the feet upwards or downwards. (6)

e: After the desired position has been reached, tighten the plastic adjustment nut again by rotating it upwards.

Note: Never put cartons, wooden blocks or similar materials under the machine to balance irregularities in the level of the ground.

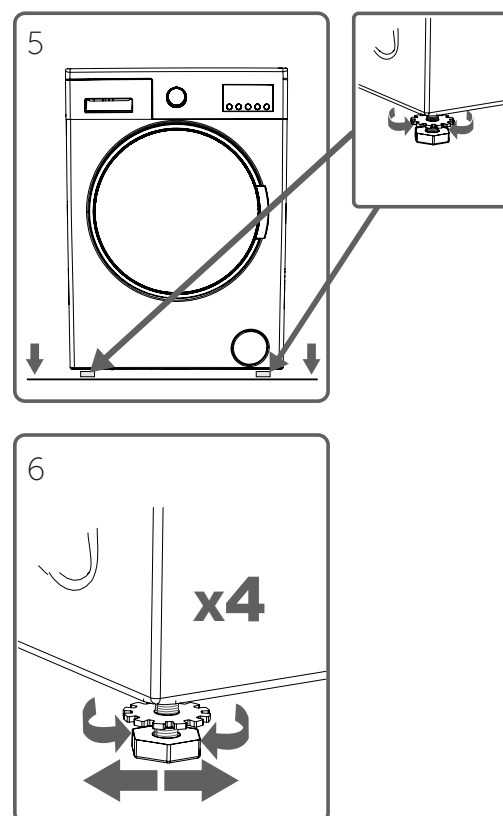

Installing your washing machine

Bringing it all together

Connections

Water inlet hose connections

Important: This washing machine MUST only be connected to a cold water supply.

a: Connect the water inlet hose, the angled connection attaches to the water inlet on the back of the washing machine. (7)

b: The straight connection attaches to the water supply valve. (8)

c: Ensure all seals are in place before connecting.

Important: Only tighten the hose connection nut by hand - do not overtighten.

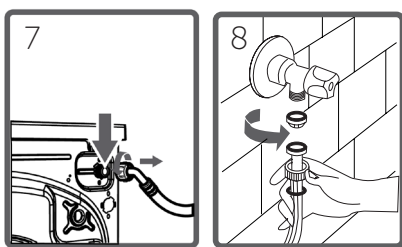

Drain hose connections

Important: The height of the top of the curve in the drain hose MUST be between 60 - 100cm from the floor. (9)

Important: The end of the water drain hose may be fitted directly to the waste water outlet hole or a special apparatus mounted on the outlet bracket of the wash-stand.

Important: Never attempt to extend the water drain hose by adding extra parts.

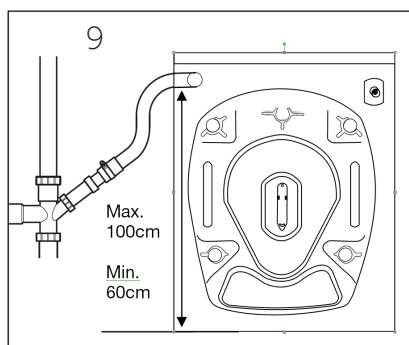

Electrical



Any electrical work that is required to install this washing machine MUST be carried out by a qualified electrician.



THIS APPLIANCE MUST BE EARTHED

Before making any electrical connections, ensure that:

- The power socket is suitable for the maximum power of the washing machine (fuses in the power circuit must be 13 amp).
- The supply voltage should be the same as that indicated in the technical specifications and the appliance rating plate (located where shown).
- The appliance should be earthed and in compliance with the applicable law.
- Additional earth cables should not be necessary if the plug and socket are earthed. If necessary, an additional earth cable should be attached to the earth terminal on the back of the washing machine and earthed.
- When installed, the power socket must be within easy reach.
- The use of adapters, multiple connectors or extension cables are not recommended.
- The appliance must be connected to a 220-240 volt 50 cycle AC supply by means of a three pin socket, suitably earthed and protected by a 13 amp fuse.
- Should the fuse need to be replaced, a 13 amp fuse approved to BS1363/A must be used.
- The plug contains a removable fuse cover that must be refitted when the fuse is replaced. If the fuse cover is lost or damaged, the plug must not be used until a replacement cover has been fitted or the plug is replaced.
- A damaged plug should be cut off as close to the plug body as possible, the fuse should be removed and the plug disposed of safely.

Installing your washing machine

Bringing it all together

Plug replacement (UK & Ireland only)

Should you need to replace the plug; the wires in the power cable are coloured in the following way:

Blue – Neutral 'N'

Brown – Live 'L'

Green & Yellow – Earth 'E'

The green & yellow wire must be connected to the terminal in the plug that is marked with the letter E or by the earth symbol.

The blue wire must be connected to the terminal that is marked with the letter N.

The brown wire must be connected to the terminal that is marked with the letter L.

If the power lead is damaged, it must be replaced by a qualified electrician.

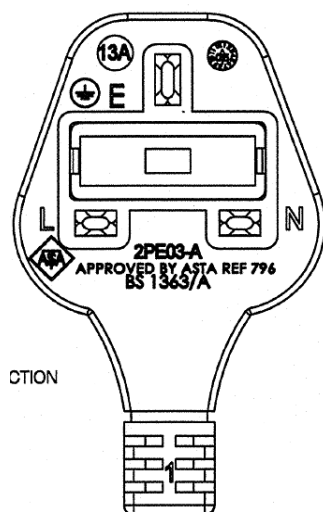

If you require any technical guidance or find that your product is not operating as intended, a simple solution can often be found in the **Troubleshooting** section of these instructions, or online at www.argos-support.co.uk If you still require further assistance, call one of our experts on **0345 257 7271**.

Functions 4



Functions

Simple everyday use

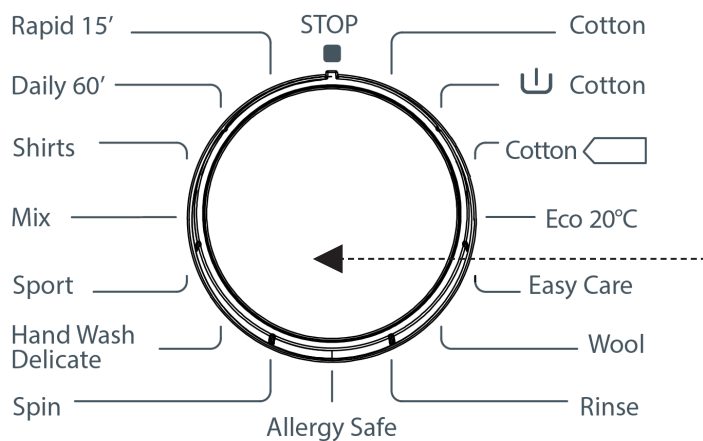

Programme selection knob
For you to select different washing programme.

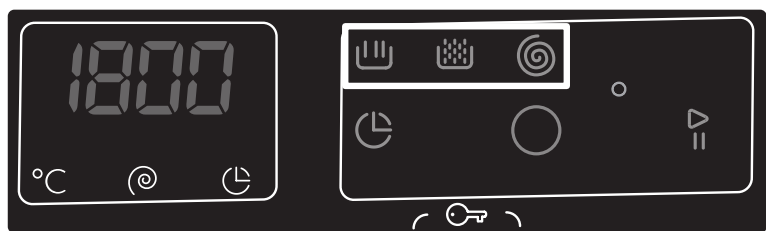

Auxiliary functions setting
Press the button repeatedly to set the Delay time. Temperature, speed and so on.

Start/Pause
Press the button to start or pause the wash cycle

If you require any technical guidance or find that your product is not operating as intended, a simple solution can often be found in the **Troubleshooting** section of these instructions, or online at www.argos-support.co.uk If you still require further assistance, call one of our experts on **0345 257 7271**.

Functions

Simple everyday use

WASHING SEQUENCE

- Plug your machine into the mains power supply.
- Open the water tap.
- Open the washing machine door.
- Load your items of clothing into the drum, ensuring they are loosely packed.
- Push the door of your machine until you hear the locking sound to close it.

Selecting programme

Select the programme appropriate for your laundry from the programme table (Page-22).

EXTRA FUNCTIONS

Before starting the programme you can optionally select an extra function.

- Press on the button of extra function you would like to select.
- If an auxiliary function symbol on the electronic display flashes continuously, the extra function you have selected will be activated.
- If an extra function symbol on electronic display blinks, the extra function you have selected will not be activated.

Reason for non-activation:

- The extra function you want to use in the washing programme you have selected is not applicable.
- Your machine has passed over the stage, during which the extra function you would like to select would be implemented.
- It is not compatible with an extra function you have selected previously.

1- Temperature selection

You can select the washing water temperature with the washing water temperature selection button.

Whenever you select a new programme, the maximum washing water temperature is shown on the washing water temperature selection.

You can gradually decrease the washing water temperature between the maximum temperature and cold washing (--) by pressing washing water temperature selection button.

If you have missed the washing water temperature you wanted, you can return to the intended temperature by continuously pressing the washing water temperature selection button.

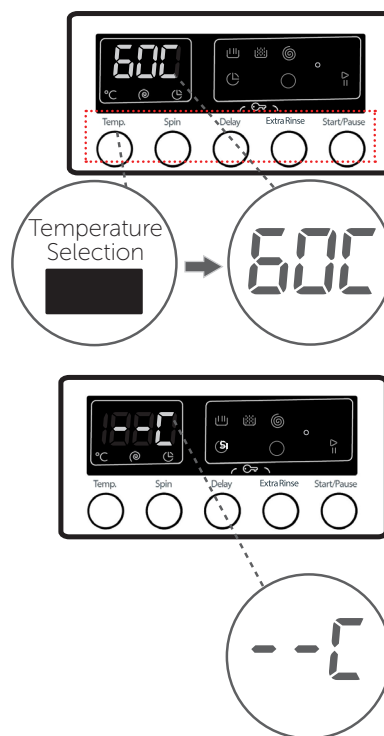

2- Spin Speed Selection

You can set the spin revolution for your laundry via spin speed button.

When you select a new programme, the maximum spin revolution speed of the programme you have selected will be viewed on the display of revolution speed.

You can gradually reduce the revolution speed between cancel spinning (--) options through the maximum spin revolution of the programme selected by pressing revolution spin speed button.

Functions

Simple everyday use

If you have skipped the spinning revolution you want to set, you can re-switch to the revolution by keeping the revolution setting button pressed.

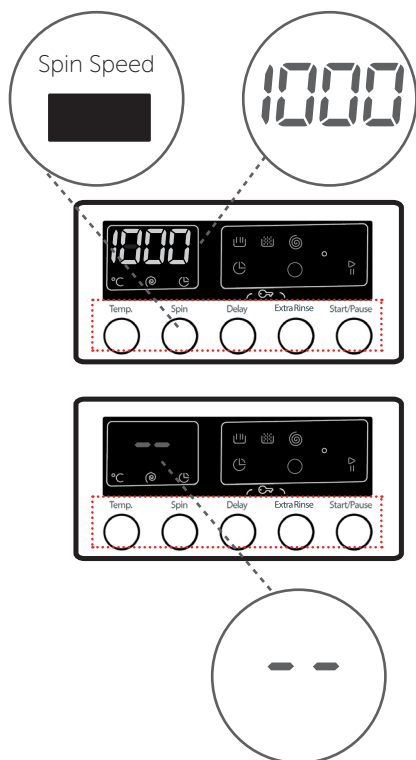

3- Delay timer

Instead of starting the programme immediately you can set the programme to start automatically after a set period of time. This time can vary from an hour to 23 hours.

To use the auxiliary function of delay timer:

- 1- Press delay timer button once.
- 2- "1 h" will appear on the display. - Symbol  will flash on the electronic display.
- 3- Repeatedly press the delay timer button until the desired number of hours delay are shown on the display.
- 4- To activate the timer delay press on any auxiliary function button except the "Start/Pause" button.

If you have skipped the time delay you wanted to set, you can go back to the time desired by keeping

pressing on the delay timer button.

If you want to cancel the time delay, you are required to press the time delay button once.  symbol will no longer flash on electronic display.

To run time delay function, your machine needs to be operated by pressing on Start/Pause button.

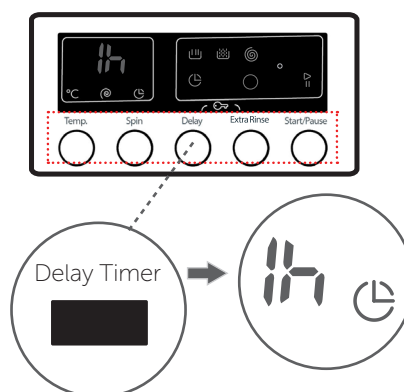

4- Extra Rinse

Select this function by pressing the Extra Rinse button when the Extra Rinse indicator  is displayed.

You may make the programme active by pressing the extra rinsing auxiliary function button when the LED light of the  symbol turns on.

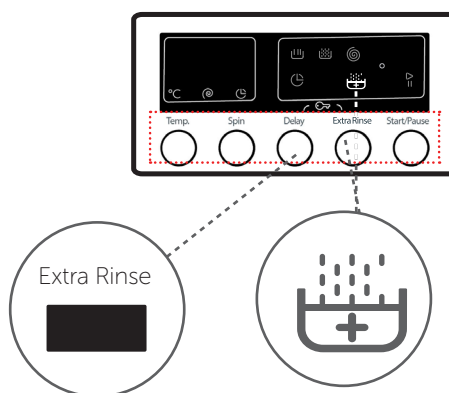

Functions

Simple everyday use

Start/Pause button

By pressing on the Start/Pause button, you may start the programme you have selected or suspend a running programme. If you switch your machine to the standby mode, the start/pause LED indicator on the electronic display will blink.

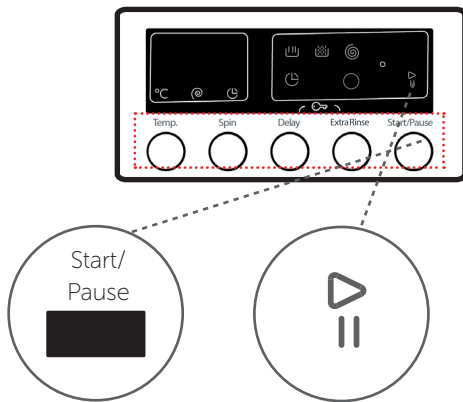

Child Lock

To avoid programme flow from being affected if programme buttons are pressed or programme button is turned when performing washing operation in your machine a child lock is available.

Press and hold both the Delay and Extra Rinse buttons for 3 seconds to activate the child lock.

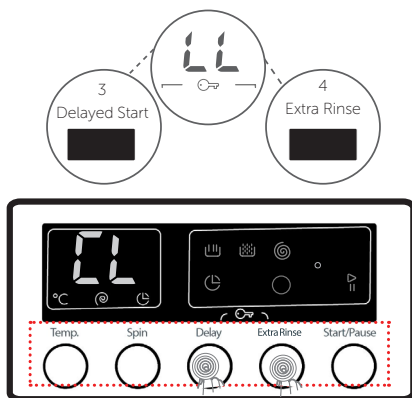

"CL" symbol will flash on the electronic display when activated.

If you press any button, while the child lock is active, the "CL" symbol will blink on the electronic display.

If while the child lock is engaged and any programme

is running, the programme knob is switched to the CANCEL position and another programme is selected, the programme previously selected continues from where it left off.

To deactivate the child lock, press and hold the same buttons used to activate it for 3 seconds, and the 'CL' symbol on the display will turn off.

Cancelling Programme

If you want to cancel any programme running:

- 1- Turn off the programme knob to STOP (OFF) position.
- 2- Your machine will stop the washing operation and the programme will be cancelled.
- 3- To get rid of the water accumulated in the machine switch the programme knob to any programme.
- 4- Your machine will perform the necessary discharge operation and cancel the programme.
- 5- You can run your machine by selecting a new programme.

Finishing Programme

Your machine will stop by itself as soon as the programme you have selected finishes.

- "End" led will blink on the display panel.

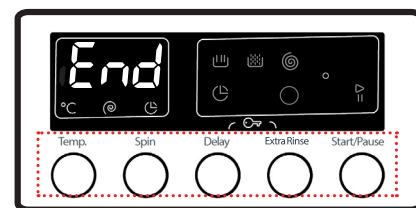

- You can open the machine's door and remove the laundry.

- Leave the door of your machine open to allow the inner part of your machine to dry after removing your laundry.

- Turn the programme knob to cancel position.

- Unplug your machine.

- Turn off the water tap.

Functions

Simple everyday use

Programme Selection Guide

Programme	Washing temperature (°c)	Prog. Time (mins) WMDF814B WMDF814W	Detergent compart.	/Max load capacity (kg) WMDF814B WMDF814W	Type of laundry
Cotton 90°	90°	187	2	8,0	Very dirty, cotton and flax textiles. (Underwear, linen, tablecloths, towels (maximum 4,0 kg), bedclothes, etc.
Pre-wash cotton	60°	164	182	8,0	Dirty cotton and flax textiles. (Underwear, linen, tablecloths, towels (maximum 4,0 kg), bedclothes, etc.
Cotton eco	60°	240	2	8,0	Dirty cotton and flax textiles. (Underwear, linen, tablecloth, towel (maximum 4,0 kg), bedclothes, etc.
Eco	20°	96	2	4,0	Less dirty, cotton and linen textiles. (Underwear, bedsheet, tablecloth, towel (max. 2 kg) bedcloth, etc.
Easy care	40°	89	2	3,5	Very dirty or synthetic-mixed textiles. (Nylon socks, shirts, blouses, synthetic-including trousers etc.)
Wool	30°	43	2	2,5	Woolen clothing with machine wash labels.
Rinse	-	42	-	8,0	If you want to additionally rinse your laundry upon completion of the washing operation, you may use this programme for any type of laundry.
Allergy safe	60°	226	2	4,0	Baby clothes
Spin	-	17	-	8,0	If you want to additionally wring your laundry upon completion of the washing operation, you may use this programme for any type of laundry.
Hand wash/ delicate	30°	90	2	2,5	Laundry recommended for hand wash or sensitive laundry.
Sports wear	30°	80	2	3,5	Sportswear
Mixed	30°	81	2	3,5	Dirty cotton, synthetics, colour and flax textiles can be washed together.
Blouses / shirts	60°	112	2	4,0	Dirty cotton, synthetic and synthetic-mixed shirts and blouses can be washed together.
Daily 60 min.	60°	60	2	4,0	You can wash your dirty cotton, colour and flax textiles at 60°C in 60 minutes.
Rapid 15 min.	30°	15	2	2,0	You can wash your slightly stained, cotton, coloured and flax textile within only 15 minutes.

(*) You can use softeners in all programmes (except spinning and draining programmes) optionally. When you arrange the quantity of the softener, comply with the warning of the softener producer. Fill your softener in the  (softener) compartment of the detergent drawer.

Note: Durations vary according to wash load (weight and type), tap water, ambient temperature and selected extra functions.

If you require any technical guidance or find that your product is not operating as intended, a simple solution can often be found in the **Troubleshooting** section of these instructions, or online at www.argos-support.co.uk If you still require further assistance, call one of our experts on **0345 257 7271**.

Using your washing machine

5



Using your washing machine



























Getting the most from your appliance

- Your laundry has product labels on them that specify their specifications. Wash or dry your laundry according to the specifications on the product label.
- Separate your laundry according to their types (cotton, synthetic, sensitive, wool etc.), their temperatures (cold, 30°, 40°, 60°, 90°) and degree of contamination (slightly stained, stained, highly stained).
- Never wash your coloured and white laundry together.
- Wash your coloured laundry separately in the first washing as they may bleed.
- Ensure that there are no metallic materials on your laundry or in the pockets; if so, take them up.

CAUTION: Faults that will emerge in case of penetration of foreign substances into your machine are not included within the scope of warranty.

- Zip up and button up your laundry.
- Remove the metallic or plastic hooks of tulle curtains or curtains or place them in a washing net or bag and then muzzle them.
- Reverse textiles such as pants, knitwear, t-shirt and sweat suit.
- Wash socks, handkerchief and suchlike small laundry in a washing net.

PUTTING LAUNDRY IN THE MACHINE

 Normal wash	 Warm wash (max 40 °C)	 Hand wash	 Bleach	 Chlorine bleach may be used	 Tumble dry, Medium (max 150 °C)
 Gentle wash	 Do not wash	 Do not bleach	 Do not iron	 Dry clean	 Tumble dry normal
 Cool iron (max 110 °C)	 Warm iron medium (max 150 °C)	 Do not dry clean	 Dry clean normal cycle with any solvent	 Dry clean normal cycle petroleum solvent only	 Drip dry
 Iron with cloth	 Dry after wash	 Warmly dry clean	 Line Dry	 No Wring	 No machine wash
 Steam iron	 Line Dry in shade	 Do not tumble dry			

- Open the door of your machine.
- Spread your laundry in your machine.

NOTE: Maximum loading capacity may vary based on the laundry type you will wash, degree of contamination and the programme you have chosen. Do not exceed maximum dry loading capacity indicated in the programme table for washing programmes.

You can take the following table of weights as an example.

- Put each item of laundry separately.
- Ensure that no laundry is stuck between the cover and bellow seal when closing the door of your machine.
- Push the door of your machine until hearing the locking sound to close it.
- Close the door of your machine properly, otherwise your machine will not start the washing operation.

LAUNDRY TYPE	WEIGHT (g)
Towel	200
Linen	500
Bathrobe	1200
Quilt cover	700
Pillow slip	200
Underwear	100
Tablecloth	250

ADDING DETERGENT INTO MACHINE

The amount of detergent you will put in your machine will depend on the following criteria:

- Your detergent utilization will be based on the degree of contamination of your laundry. Do not prewash your less stained laundry and put your slight amount of detergent in the 2nd compartment of the detergent drawer.
- For your much stained laundry, select a programme including prewashing, and put ¼ of the detergent you will put in the detergent drawer in the 1st compartment of the detergent drawer while putting the remaining ¾ of it into 2nd compartment.

If you require any technical guidance or find that your product is not operating as intended, a simple solution can often be found in the **Troubleshooting** section of these instructions, or online at www.argos-support.co.uk If you still require further assistance, call one of our experts on **0345 257 7271**.

Using your washing machine

Getting the most from your appliance

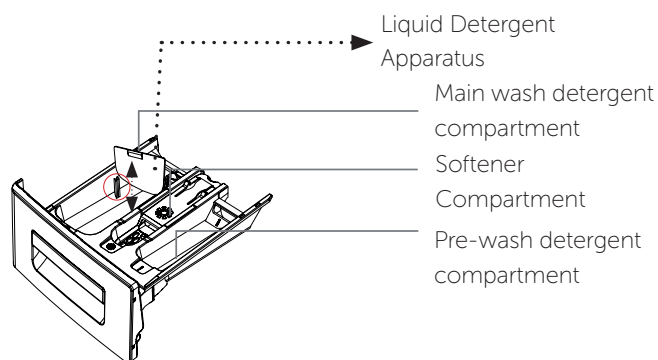

- Use detergents produced for automatic washing machine in your machine. The amount of detergent you will use for your laundry is printed on the detergent package.
- The higher the degree of hardness of the water the more detergent you will use.
- The amount of the detergent you will use will increase as the amount of your laundry increase.
- Put the softener in the softener compartment in the detergent drawer. Do not exceed the MAX level. Otherwise, softener will flow into washing water through flushing.
- Softeners with high density are required to be thinned to a degree before being put in the drawer. Because high-density softener will clog the flush and avoid the flow of the softener.
- You can use your liquid detergents in all programmes without prewashing. For this, fit liquid detergent level plate in the accessories bag or the liquid detergent apparatus (*) into 2nd compartment of the detergent drawer and set the amount of liquid detergent according to the levels on this plate. Remember to detach the liquid detergent plate.

(*)Machinery specifications may vary depending on the product purchased.

Using your washing machine

Getting the most from your appliance

Quick start

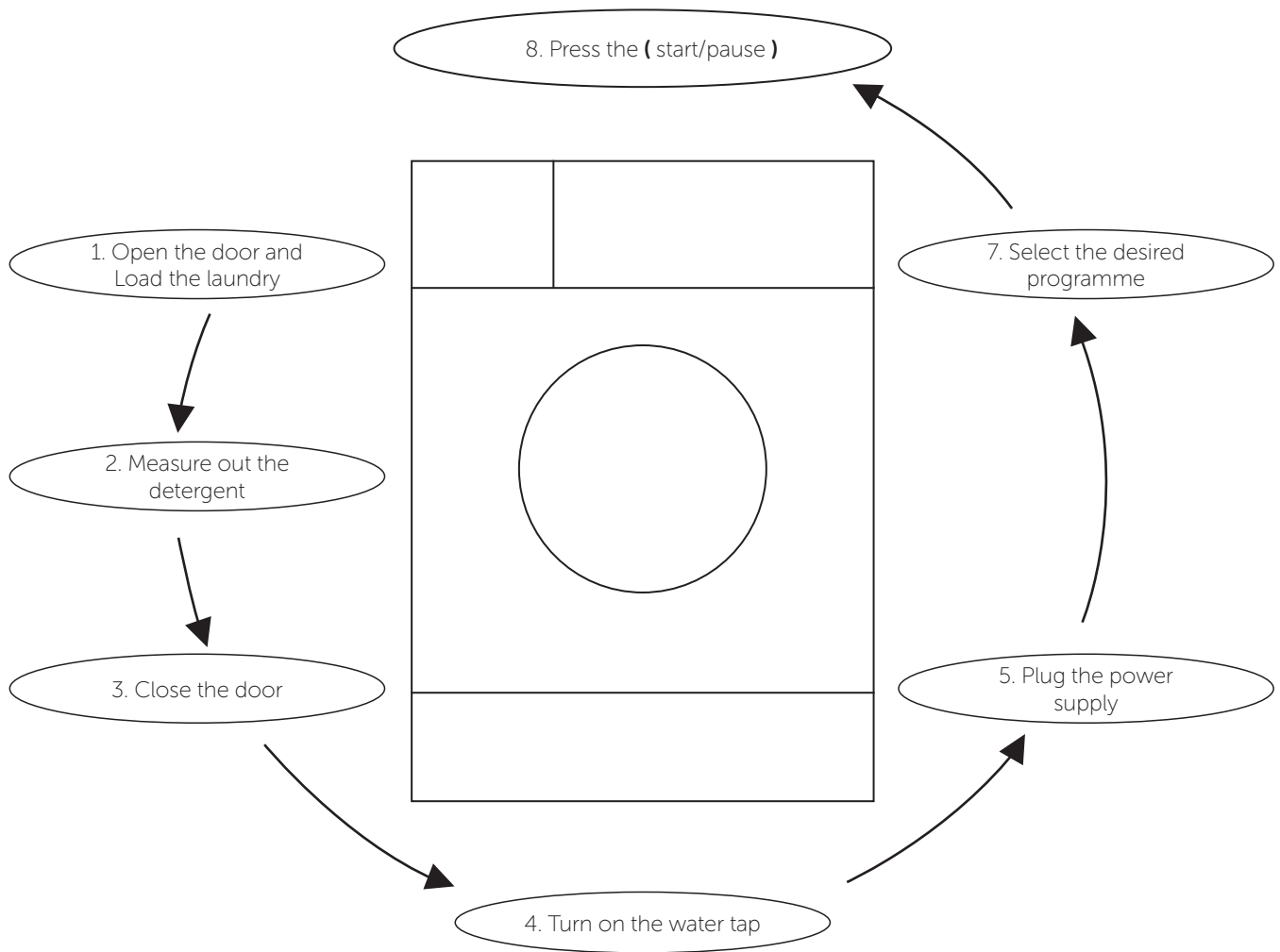

If you require any technical guidance or find that your product is not operating as intended, a simple solution can often be found in the **Troubleshooting** section of these instructions, or online at www.argos-support.co.uk If you still require further assistance, call one of our experts on **0345 257 7271**.

Care and maintenance

6



Care and maintenance

Looking after your appliance



Before cleaning your washing machine.

a: Unplug your machine from the mains power supply.

b: Close the water tap.

Water inlet filters

On the tap part of your machine's water inlet hose and at the ends of water inlet valves, there are filters to prevent entrance of the dirt and foreign materials in the water to the machine. If the machine is unable to receive sufficient water even though your water tap is fully opened, filters should be cleaned.

- Remove the water inlet hose.
- Remove the filters found on the water inlet valves by using a pincer and wash thoroughly with a brush. (1)
- Clean the filters of the water inlet hoses located on the tap side by removing manually together with the seal. (2)
- After you clean the filters, you can fit them the same way as you have removed them.

Pump filter

The pump filter system elongates the life of your pump, which is used to drain the dirty water. It prevents dirt entering the pump. Cleaning of your pump filter every 2-3 months is recommended. To clean your pump filter:

- To open the pump cover, you can use the powder detergent spade (*) or liquid detergent level plate coming out of your machine. (1-A & 2-A)
- Before opening the filter cover, place a cup in front of the filter cover to prevent flow of the remaining water in the machine.
- Clean the foreign materials in the filter with a brush and flush with clean water. (3-A)
- Check for the rotation of the pump manually.
- After cleaning the filter, fit the filter cover and tighten it by rotating it in clockwise direction. (4-A)
- Remove the foreign materials from the filter.
- Do not forget that if you do not fit the filter cover properly, it will leak water.

• While closing the pump cover, ensure that the parts on the inner side of the cover match the holes on the front panel side. (5-A)

• You can reattach the pump cover in the reverse order that you removed it.



Danger of being scalded!

The water inside the pump maybe hot- wait for it to cool.

(*) Machinery specifications may vary depending on the product purchased.

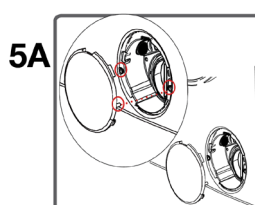
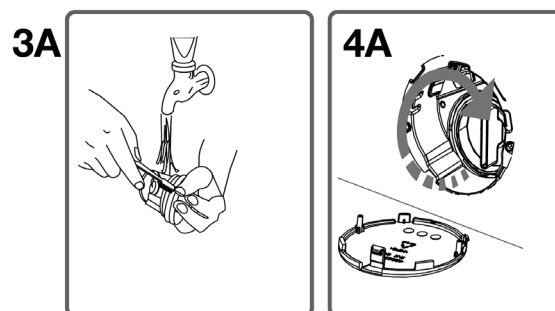
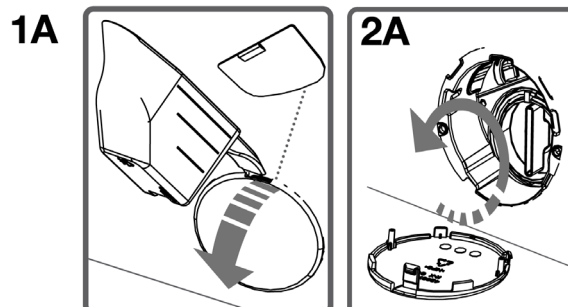
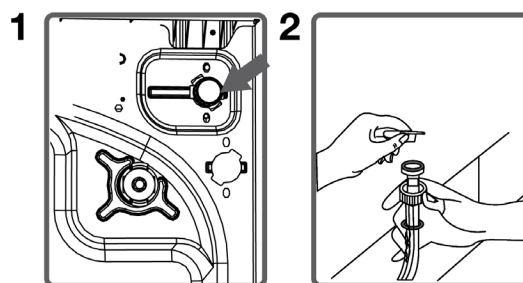

If you require any technical guidance or find that your product is not operating as intended, a simple solution can often be found in the **Troubleshooting** section of these instructions, or online at www.argos-support.co.uk If you still require further assistance, call one of our experts on **0345 257 7271**.

Care and maintenance

Looking after your appliance

Detergent drawer

Detergents may form sediments in your detergent drawer or in the housing of the detergent drawer over time. To clean the sediment, pull out the detergent drawer from time to time. To pull out the detergent drawer:

- Pull the detergent drawer to the end. (1)
- Keep on pulling by depressing on the section shown below in the detergent drawer and keep pulling and then remove the detergent drawer. (2&3)
- Clean the detergent drawer with a soft brush like an old toothbrush and flush with clean water.
- Collect residues in the housing of the detergent drawer without dropping them inside the machine.
- Assemble the detergent drawer after drying it using a towel or dry cloth.
- Do not wash your detergent drawer in a dishwasher!

Liquid Detergent Apparatus (*)

Take out the liquid detergent level apparatus for cleaning and maintenance purposes as shown in the picture and clean away detergent residues. Put the apparatus back into its place. Make sure no residues are left inside.

(*) Machinery specifications may vary depending on the product purchased.

Siphon plug

Pull out the detergent drawer. Remove the siphon plug and clean any residues away. Fit the cleaned siphon plug in its location. Check it is placed properly. (3)

Cabinet

Clean the exterior surface of the cabinet of your machine with lukewarm water and a cleaning substance that will not damage the cabinet. After rinsing with clean water, wipe it with a soft and dry cloth.

Note: To get the best out of your machine. We recommend that you periodically run a wash cycle with

limescale remover, especially in hard water areas.

Note: After each wash leave the door of the machine open to help air the drawer and reduce any mould build up;

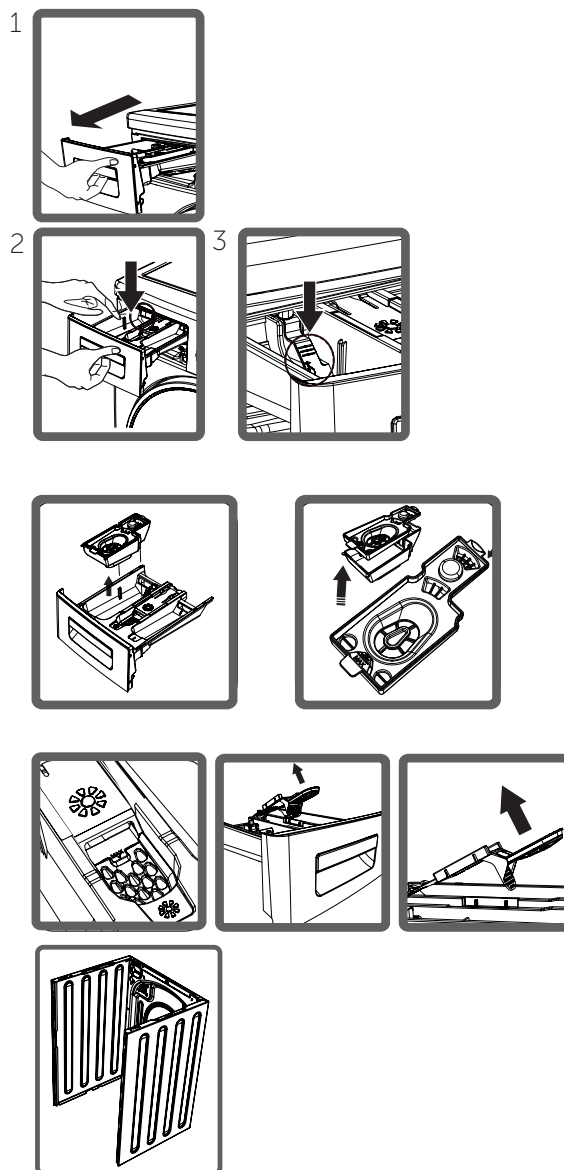

Note: Wipe the door seal ideally after each wash;

Note: Undertake a maintenance wash every 4-6 weeks with the drum empty. This wash should be undertaken with lime scale and detergent remover;

Care and maintenance

Looking after your appliance

Drum

Do not leave metallic objects such as needles, paper clips, coins etc. in your machine. These objects lead to stains in the drum. To clean such rust stains, use a non-chlorine cleaning agent and follow the instructions of manufacturers of the cleaning agent. Never use wire wool or similar hard objects for cleaning rust stains.

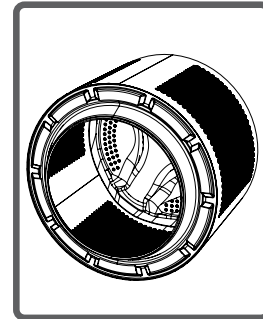

Product support

7



Product support

Help is always at hand

All repairs to the machine must be carried out by an authorised repair agent. When a repair is required or you are unable to eliminate the failure with the help of the information below:

a: Unplug the machine.

b: Close the water tap.

c: Contact the nearest authorised repair agent.

FAILURE	PROBABLE CAUSE	METHODS OF ELIMINATION
Your machine does not operate.	It is unplugged.	Insert the plug into the socket.
	Your fuse is defective.	Change your fuse.
	The electric power is off.	Check the electric power.
	Start/pause button has not been pressed.	Press the start/pause button.
	The programme knob is in the 0 (off) position.	Turn the programme knob to the desired position.
	The door is not shut properly.	Shut the door properly. You should hear the click.
Your machine does not receive water.	Water tap is closed.	Open water tap.
	The water inlet hose may be bent.	Check the water inlet hose.
	The water inlet hose is obstructed.	Clean the filters of water inlet hose. (*)
	The valve inlet filter is obstructed.	Clean the valve inlet filters. (*)
	The door is not shut properly.	Shut the door properly. You should hear the click.
Your machine is not draining water.	The drain hose is obstructed or bent.	Check the drain hose.
	The pump filter is obstructed.	Clean the pump filter. (*)
	The clothes are not placed inside the machine in a well-balanced manner.	Spread the clothes inside the machine in an orderly and well-balanced manner.
Your machine is vibrating.	The feet of your machine are not adjusted.	Adjust the feet. (**)
	Transportation screws are not removed.	Remove transportation screws. (**)
Your machine is vibrating.	There are only few clothes in the device.	It does not prevent operation of the machine.
	Excessive amount of clothes are filled in the machine or the clothes are not placed in a well-balanced manner.	Do not exceed the recommended quantity of clothes and spread your clothes in the machine in a well-balanced manner.
	Your machine is touching a rigid object.	Ensure machine is not in contact with hard objects.

(*) See the section concerning the care and maintenance of your machine.

(**) See the section concerning installation of your machine.

If you require any technical guidance or find that your product is not operating as intended, a simple solution can often be found in the **Troubleshooting** section of these instructions, or online at www.argos-support.co.uk If you still require further assistance, call one of our experts on **0345 257 7271**.

Product support

Help is always at hand

FAILURE	PROBABLE CAUSE	METHODS OF ELIMINATION
Excessive foam in the detergent drawer.	Too much detergent has been used.	Press the start/pause button. In order to stop the foam, dilute one table-spoon of softener in half liter of water and pour it in the detergent drawer. Press the start/pause button after 5-10 minutes. Arrange the amount of the detergent properly in the next washing process.
	Wrong detergent has been used.	Use only the detergents produced for full automatic machines.
The washing result is poor.	Your laundry is too dirty for the programme you have selected.	Select a suitable programme.
	The amount of detergent used is not sufficient.	Use more detergent.
The washing result is not good.	Clothes exceeding the maximum capacity have been loaded in the machine.	Put the clothes in your machine in a manner not to exceed its maximum capacity.
	Your water may be hard.	Use the amount of detergent specified by the detergent manufacturer.
	Distribution of the clothes in your machine is not well-balanced.	Spread the clothes inside the machine in an orderly and well-balanced manner.
The water is drained from the machine as soon as it is filled.	The end of the water drain hose is in a position too low according to the machine.	Position the water drain at an appropriate height. (**)
No water is seen in the drum during washing.	No failure. The water is in the lower part of the drum.	-
There are residues of detergent on the clothes.	Some detergents contain ingredients which are not soluble in water and which may form white stains on your clothes.	By adjusting your machine, carry out an additional rinse, or eliminate the stains after drying, with a brush.
There are grey stains on the clothes.	These stains may be caused by oil, cream or ointment.	In the next washing operation, use the maximum detergent amount declared by the detergent producer.
The spinning process is not done or starts with delay.	No failure. The unbalanced load control may work in that way.	The unbalanced load control system will try to distribute your clothes in a homogenous manner. After your clothes are distributed, passage to spinning process will be realized. In the next washing process, place your clothes into the machine in a well-balanced manner.

(*) See the section concerning the care and maintenance of your machine.

(**) See the section concerning installation of your machine.

If you require any technical guidance or find that your product is not operating as intended, a simple solution can often be found in the **Troubleshooting** section of these instructions, or online at www.argos-support.co.uk. If you still require further assistance, call one of our experts on **0345 257 7271**.

Product support

Help is always at hand

Error Signals

Your machine is equipped with systems which will take the necessary precautions and warn you in case of any.

IMPORTANT: IT CAN TAKE UPTO 10 MINUTES FOR ERROR TO REGISTER.

Failure code	Probable failure	Process to be followed
E01	The door is not shut properly.	Shut the door properly so that you hear the click. If the problem persists, turn off the machine unplug and contact the nearest authorised service agent immediately.
E02	The water level in your machine is below heater. The pressure of your water supply may be low or water supply may be blocked.	Turn on the tap fully. The water supply may be interrupted. If the problem persists, your machine will automatically stop after a while. Unplug your machine, turn off the tap and contact the nearest authorised service agent immediately.
E03	The pump has failed or the pump filter is obstructed.	Clean the pump filter. If the problem persists and contact the nearest authorised service agent immediately. (*)
E04	Your machine has excessive amount of water.	Your machine will discharge water by itself. Pursuant to discharging operation, turn off your machine and unplug it. Turn off your tap and contact the nearest authorised service.

(*) See the section regarding the care and maintenance of your machine.

If you require any technical guidance or find that your product is not operating as intended, a simple solution can often be found in the **Troubleshooting** section of these instructions, or online at www.argos-support.co.uk If you still require further assistance, call one of our experts on **0345 257 7271**.

Product support

Help is always at hand

Technical Specifications

Model / Item	WMDF814B	WMDF814W
Power supply	(220-240) V ~/50Hz	(220-240) V ~/50Hz
Max working current	10 amp	10 amp
Water pressure	Maximum : 1Mpa Minumum : 0.01 MPa	Maximum : 1Mpa Minumum : 0.01 MPa
Maximum power	2200 watt	2200 watt
Maximum washing load (dry)	8 kg	8 kg
Spinning speed	1400 rpm	1400 rpm
Washing programmes	15	15
Size	845 x 597 x 557	845 x 597 x 557
Net weight	70 kg	70 kg

If you require any technical guidance or find that your product is not operating as intended, a simple solution can often be found in the **Troubleshooting** section of these instructions, or online at www.argos-support.co.uk. If you still require further assistance, call one of our experts on **0345 257 7271**.

Product support

Help is always at hand

Help and assistance

If you require any technical guidance or find that your washing machine is not operating as intended, a simple solution can often be found in the **Troubleshooting** section of these instructions or online at www.argos-support.co.uk

If you still require further assistance, call one of our experts on **0345 257 7271***. To help give us give you a fast and efficient service please have the following information ready:

Model Ref.

Serial number

Date of purchase

You can find these on the rating plate - a small information panel (usually a sticker or metal plate) on the rear of your appliance

This will be shown on your receipt

Local call rates applies*

Lines open 8am-7pm Monday to Saturday and 10am-4pm Sunday.

*Calls to Argos enquiry lines may attract a charge and set up fee from residential lines depending on your call plan/tariff. Mobile and other providers costs may vary, see www.bt.com/pricing for details.

For Security and training purposes, telephone calls to and from customer service centres maybe recorded and monitored. Calls from Republic of Ireland will attract international call charges.

If you require any technical guidance or find that your product is not operating as intended, a simple solution can often be found in the **Troubleshooting** section of these instructions, or online at www.argos-support.co.uk If you still require further assistance, call one of our experts on **0345 257 7271**.

Product support

Help is always at hand



Notes on disposal :

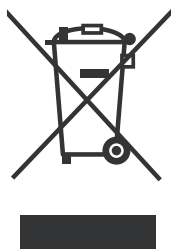

The symbol on the product or its packaging indicates that this product may not be treated as household waste. Instead it should be handed over to the applicable collection point for the recycling of electrical and electronic equipment. By ensuring this product is disposed of correctly, you will help prevent potential negative consequences for the environment and human health, which could otherwise be caused by inappropriate waste handling of this product. For more detailed information about recycling this product, please contact your local council office, your household waste disposal service or the shop where the product was purchased.

Product support

Help is always at hand

BUSH

Call us now and activate your 12 month guarantee

Thank you for choosing Bush. Your new product is guaranteed against faults and breakdowns for 12 months. Don't forget to register it with us today so we can provide you with our best possible after-sales service and useful updates.

www.bushregistration.co.uk

FREEPHONE*

0800 597 8548

Lines are open 8am - 8pm, 365 days a year. *Calls may be recorded and monitored.

Your Bush Guarantee

This product is guaranteed for twelve months from the date of original purchase. Any defect that arises due to faulty materials or workmanship will be repaired free of charge (or if applicable the product will be replaced or the purchase price refunded) where possible during this period by the dealer from who your purchased the unit.

The guarantee is subject to the following provisions:

- The guarantee does not cover accidental damage, misuse, cabinet parts, knobs or consumable items.
- The product must be correctly installed and operated in accordance with the instructions contained in the manual.
- It must be used solely for domestic purposes. The guarantee will be rendered invalid if the product is re-sold or has been damaged by inexpert repair.
- Specifications are subject to change without notice.
- Bush disclaim any liability for loss or damage arising from the breakdown of the product.
- This guarantee is in addition to and does not diminish your statutory or legal rights.

Important Data Protection Information

If you provide us with information about another person, you confirm that they have appointed you to act for them, to consent to the processing of their personal data including sensitive personal data and that you have informed them of our identity and the purposes (as set out in the Important Data Privacy notice displayed overleaf) for which their personal data will be processed.

You are entitled to ask for a copy of the information we hold about you (for which we may charge a small fee) and to have any inaccuracies in your information corrected.

For quality control and training purposes, we may monitor or record your communications with us.

If your personal details change, if you change your mind about any of your marketing preferences or if you have any queries about how we use your information, please let us know by contacting our Data Protection Officer, Domestic & General, Leicester House 17 Leicester Street, Bedworth, Warwickshire CV12 8JP.

Guarantor: Argos Limited - 489 - 499 Avebury Blvd. - Milton Keynes - MK9 2NW

If you require any technical guidance or find that your product is not operating as intended, a simple solution can often be found in the **Troubleshooting** section of these instructions, or online at www.argos-support.co.uk If you still require further assistance, call one of our experts on **0345 257 7271**.

BUSH

Contact:

www.argos-support.co.uk

Helpline: 0345 257 7271

52221268