



**CUGGL BEDRAIL GREY**

**CUGGL BEDRAIL BLUE**

**CUGGL BEDRAIL PINK**

care & instruction manual

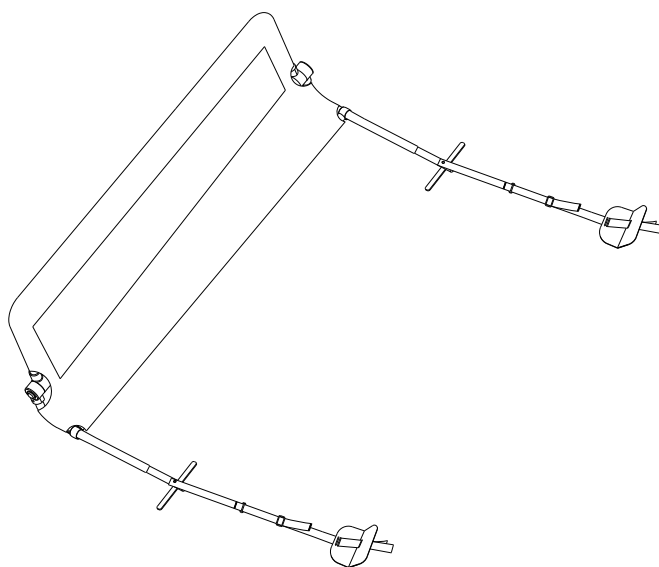

**IMPORTANT KEEP FOR FUTURE REFERENCE**



# Exploded diagram for single bedrail

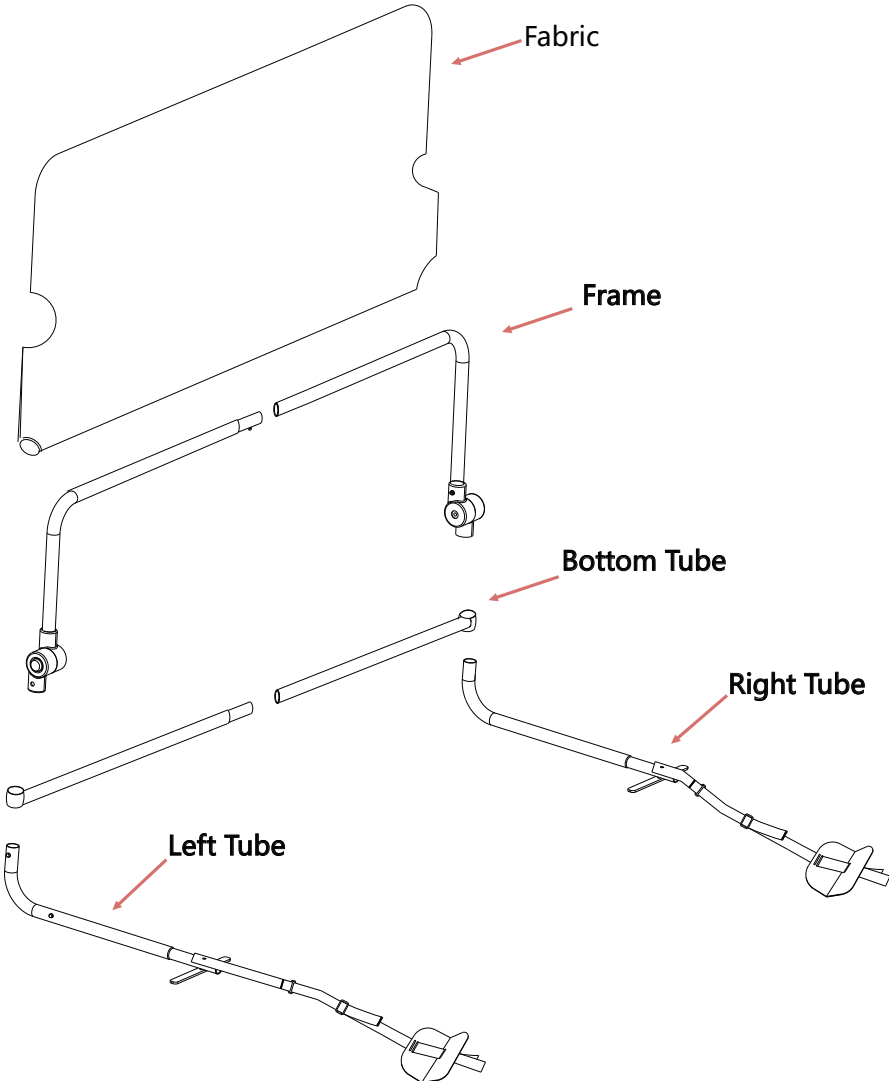

# WARNING!

It is recommended only to use the bedrail for children between 18 months and 5 years. Only use the bedrail when the child is able to climb in and out of bed unaided.

The bedrail should not be used as a substitute for a cot, as it cannot provide the same level of safety as a cot.

Once the bedrail is in locked position or when placed in the fitted position, it should touch the side of the mattress.

The bedrail is fixed to the bed or to the mattress, the bedrail should not be used unless the fixings are in place and securely attached to both the bed and/or the mattress and the bedrail.

This bedrail is designed to fit most divan or slatted style single beds with a separate mattress.

The length of the mattress and the bed must be between 150-200cm, with the width being 75cm -90cm, the thickness of the mattress must be between 8cm - 23cm.

Once fitted in place, the bedrail should be checked to ensure that it is properly fitted and secure.

The bedrail should be periodically checked for its general condition with particular reference to the security of any locking mechanism and/or hinges that are used on the product.

Additional and replacement parts should be obtained only from the manufacture.

Complies to BS 7972:2001+A1:2009

## Please check all the parts listed below:

- A - Left frame (A1) X 1 & right frame (A2) X 1
- B - Left tube ( B1 ) X 1 & right tube ( B2 ) X 1
- C - Bottom tube ( C1 & C2 ) X 1
- D - Fabric

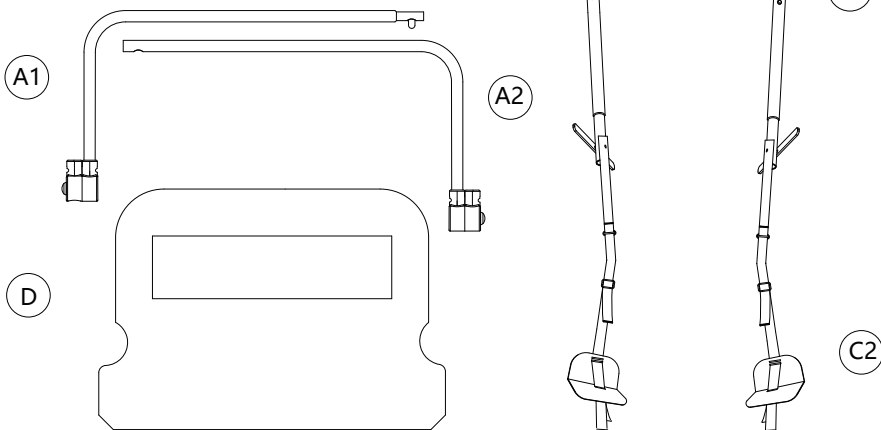

# Assembling Your Bedrail

Step 1: Put the frame through the fabric along the arrow and put the fabric together till the button is shown. Press the button and connect the two frames until the button pops up and locks in place.

( See figure 1 )

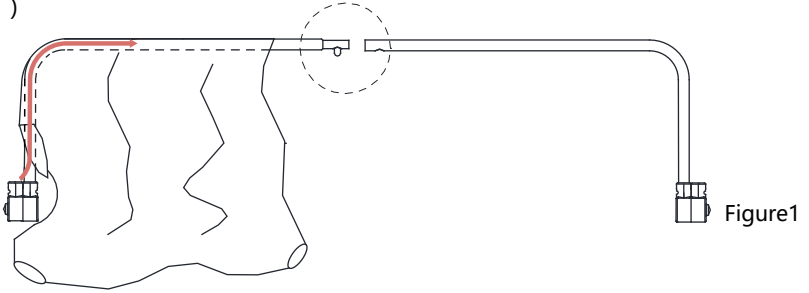

Step 2: Spread the fabric to cover the right frame as shown in figure 2.

( See figure 2 )

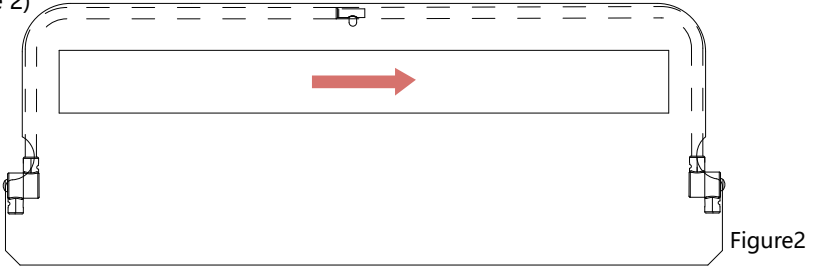

Step 3: Fix the bottom tube ( C1 & C2 ) together, and then feed through the fabric.

( See figure 3 )

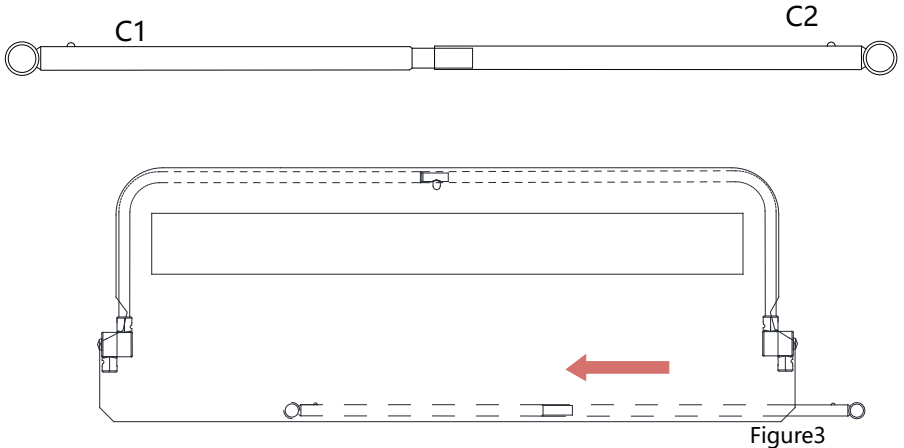

Step 4: Put the left tube ( B1 ) through the plastic ring on C1 and then feed it through the fabric. Fix it to the left hinge system until the button pops up and locks in place. (see figure 4)

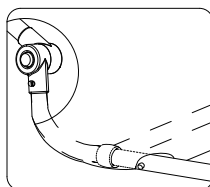
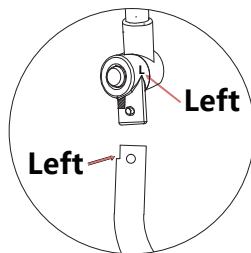
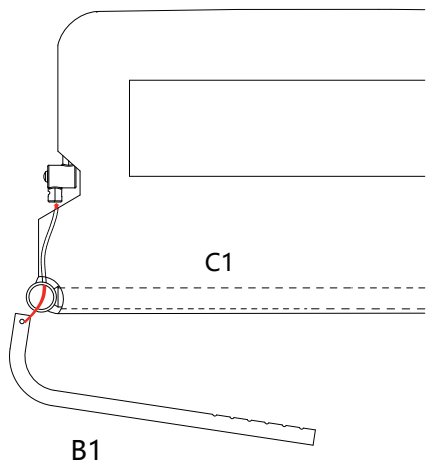

Figure4

Step 5: Put the right tube (B2) through the plastic ring on C2 and then feed it through the fabric. Fix it to the right hinge system until the button pops up and locks in place. (see figure 5)

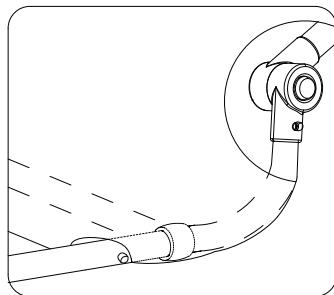
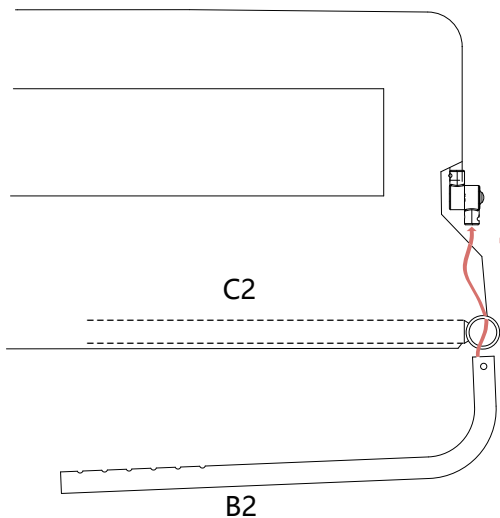
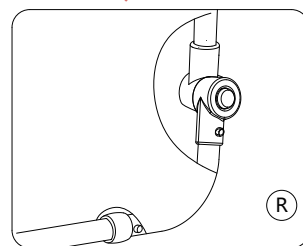
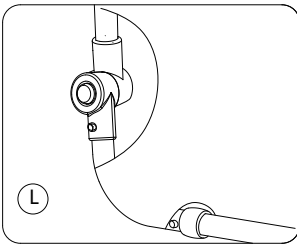
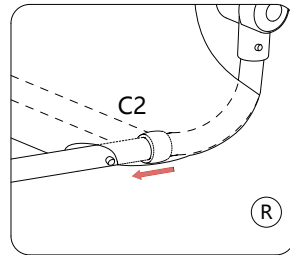
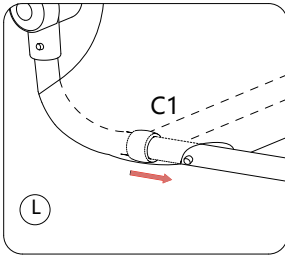
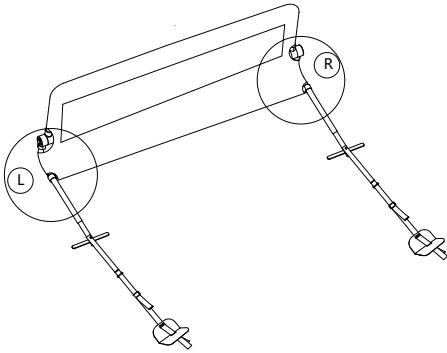
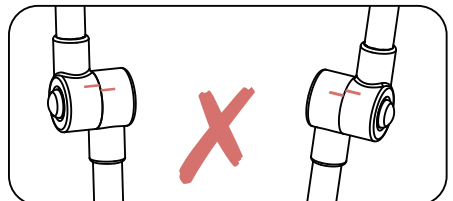
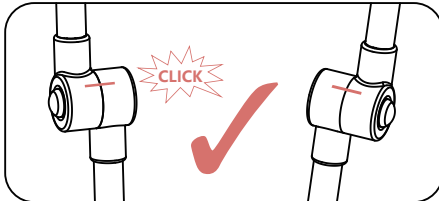

Figure5

Step 6: Slide the plastic ring on C1 and C2 behind the button . ( see figure 6 )



Step 7: To lock the side panel of the bedrail, push the top bar up until you hear a click and the red line on the hinge joins to create one line as below.



When the red line is in one line and you hear a click, the lock mechanism is engaged.

Figure6

# Installing Your Bedrail

Step 1. Remove the mattress from the bed and place the bedrail in the intended position, following the guide in step 2. Adjust the length of the straps according to the width of the mattress.

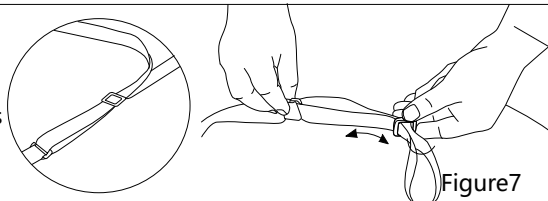

Figure7

Caution: Ensure the straps remain flat and do not twist.

( See figure 7 )

Place the mattress on the bed, make sure the steel plates are between the side of the mattress and the bed.

( See figure 8 )

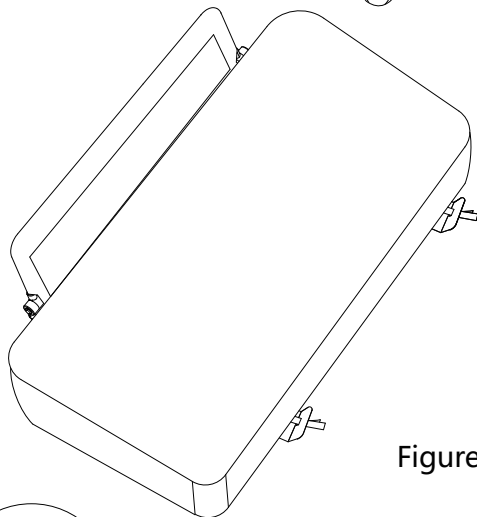

Figure8

Take hold of the lower strap, and pull it to tighten the plate against the mattress.

( See figure 9 )

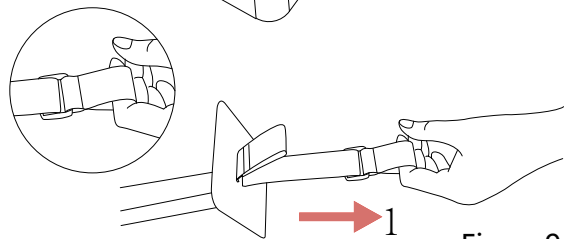

Figure9

Next, take hold of the upper strap and pull it to lock the plate in place, to ensure there is no movement against the mattress.

Ensure that the straps are hidden ( See figure 10 )

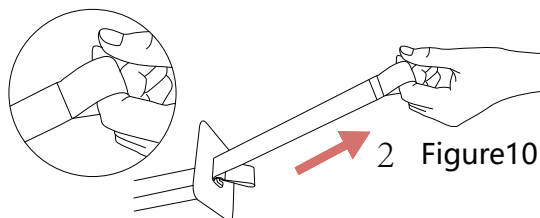

Figure10

Step 2: **WARNING:** To prevent the risk of strangulation it is essential to ensure that when the bedrail is fitted into position, there is a gap of at least 250 mm ( 10in ), between each end of the bed and the corresponding end of the bedrail. The bedrail should not be used on a bed with a sleeping surface that is more than 600 mm ( 23.6in ) from the floor. ( See figure 11 )

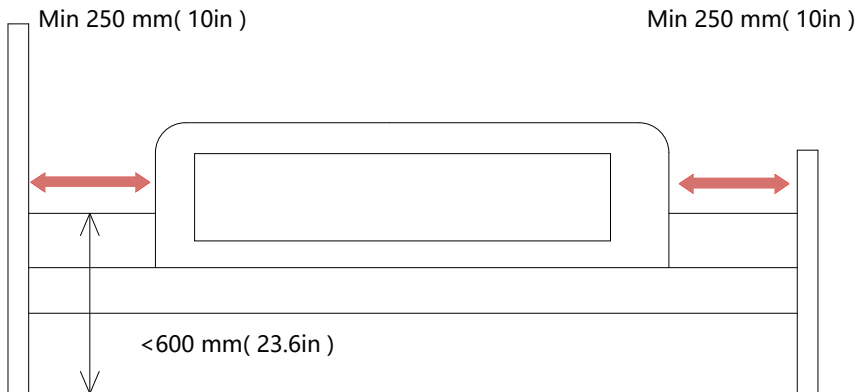

Figure11

Step 3: To fold the side of the bedrail, press the buttons on the left hinge and right hinge at the same time and lay down the upper side of the bedrail to the locked position when it is not in use. (see figure12) When in use, always ensure the side panel is locked in place by following the guide in step 7 on page 5.

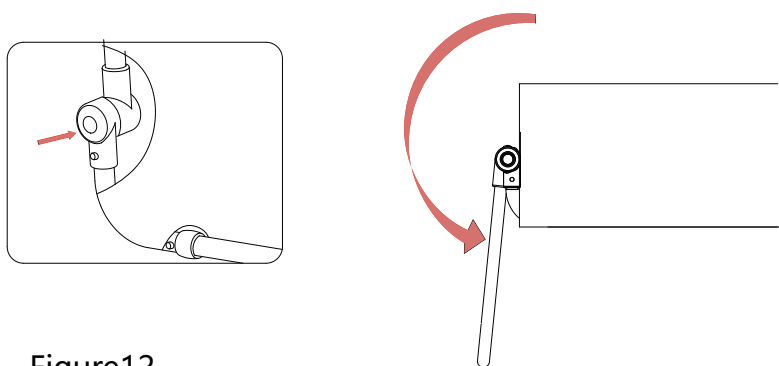

Figure12

## Folding Your Bedrail for Storing

Step 1: Remove the left/right tube. Press the upper button and then remove the left/right tube from hinge. Press the lower button and then remove them from the bottom tube. ( See figure 13 )

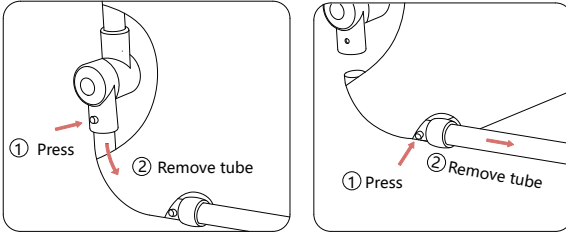

Figure13

Step 2: Slide out the bottom tube from fabric. ( See figure14 )

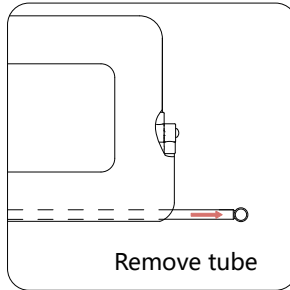

Figure14

Step 3: Push the fabric back along the top bar to reveal the middle button as shown. Press the button and pull the two sections apart. (see figure 15)

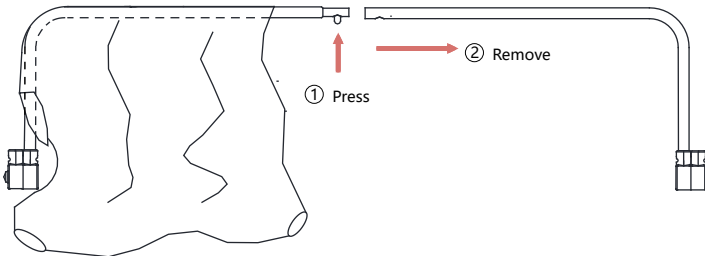

Figure15



## Care & Maintenance

Fabric composition: 100% Polyester.

Periodically check the bed rail for signs of damage, wear and/or for missing components.

Do not use if any part is missing, worn or damaged.

Check the bedrail regularly to make sure all hardware and mountings are tight and secure.

Never clean with abrasives, ammonia based, bleach based cleaners.

Make sure it is dry and clean when storing.

Proper cleaning of bedrail can be done by sponging it with warm water and mild detergent.

When you want to clean the fabric, please refer to the step1 and step2 on page 8 and then take off the fabric from the metal frame as shown in figure 16.

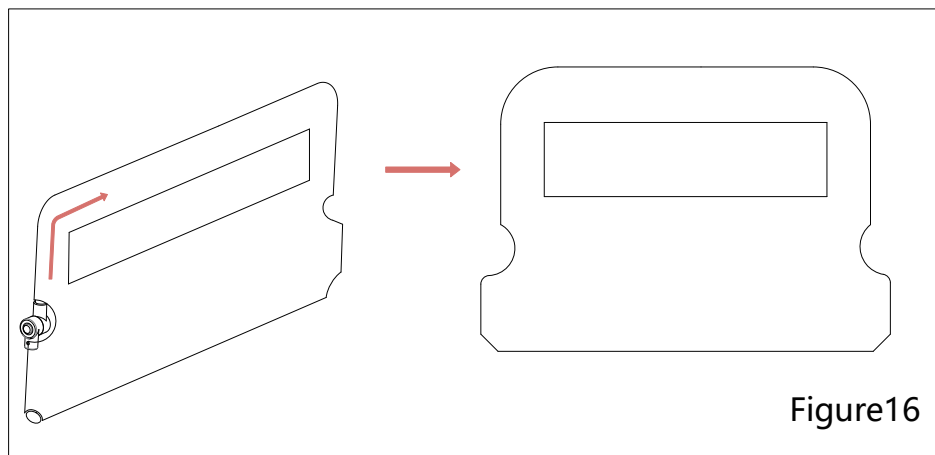

Figure16

### Customer care

#### Your child's safety is your responsibility

If you have a problem with this product or require replacement parts, please contact your nearest Argos store or telephone the Argos Customer Care Team on 0345 640 2020

Alternatively write to:

#### Customer Care Team

Produced in China. Argos Limited, 489-499 Avebury Boulevard, Milton Keynes, MK9 2NW. Argos(N.I.) Ltd, Forestside Shopping Centre, Upper Galwally, Belfast, United Kingdom, BT8 6FX

Argos Distributors(Ireland) Limited, Unit 7, Ashbourne Retail Park, Ballybin Road, Ashbourne, County Meath, Ireland

TEL 0345 640 2020

[www.argos.co.uk/cuggl](http://www.argos.co.uk/cuggl)

Please keep all the relevant information for future reference.