

# Instruction Manual



CAL. Z022, Z024 (R23 SERIES)



## FEATURES AND SPECIFICATION

- This watch is a combination quartz watch with analogue and digital displays, 3 hands analogue movement.
  - Accuracy at normal temperature:  $\pm 30$  seconds a month
  - Time keeping mode: hours, minutes, seconds, month, date, day of week, "PM" (only available in 12-hour format)
- Press S1 button to show the month and date indication.**
- Alarm Mode: Daily alarm.
  - Timer Mode:
    - Measuring unit: 1 second
    - Input range: from 1 second to 23:59'59".
  - Stop watch Mode:
    - Measuring unit: 1/100 of second
    - Measuring capacity: 23:59'59".
  - Normal operating temperature range: between -20°C and 70°C.
  - Battery type: (For Cal. Z022) CR2016, SR626SW (For Cal. Z024) CR2032, SR626SW

## DIGITAL DISPLAY A

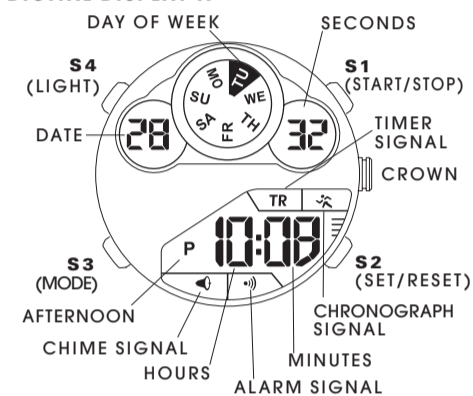

## DIGITAL DISPLAY B

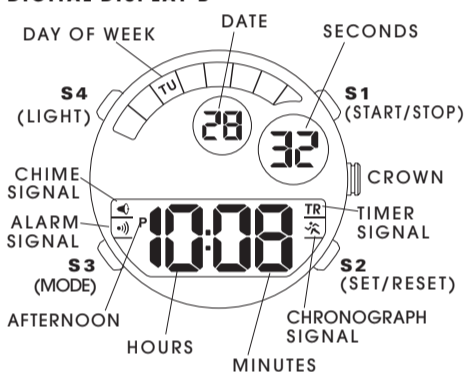

## SETTING THE TIME (ANALOGUE)

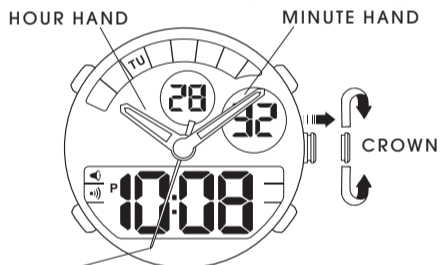

- Pull the crown out one step, the second hand will stop.
- Set the hands to the correct time by turning the crown.
- Push the crown back to the original position. The watch will start running again.

The analogue indication and digital display of the time setting can be adjusted separately.

## HOW TO CHANGE DISPLAY MODE

Press S3 button to change the display mode. Each time the button is pressed, the mode changes in the following order.

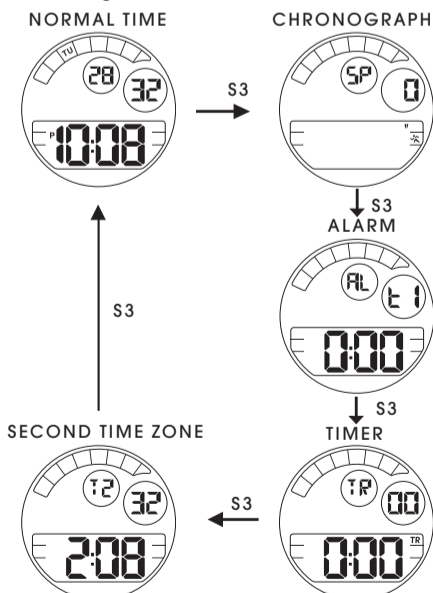

## HOW TO SET NORMAL TIME / CALENDAR

- While in the normal time mode, press S2 button once. The second digits start to flash.
- While the second digits are selected (flashing), press S1 button to reset the seconds to 00. If you press S1 button while the second count is in the range between 30 and 59, the seconds are reset to 00 and 1 is added to minutes. If the second count is in the range between 00 and 29, the seconds are reset to 00 but the minute count is unchanged.
- Press S3 button to move on to the next setting.



- Press S1 button to adjust the value. Holding S1 button down can fasten the process.
- When the 12-hour format is selected, the indicator "PM" indicates "p.m." times. There is no indicator for "a.m." times.
- Press S2 button to confirm the settings.

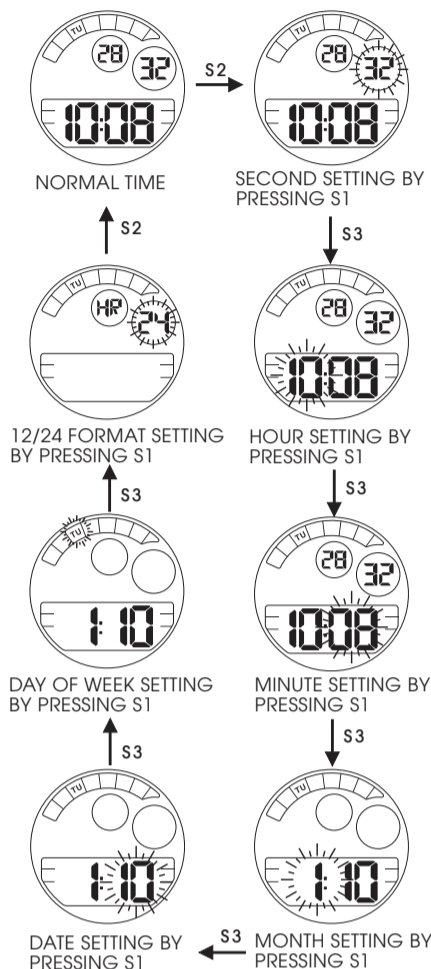

## HOW TO USE STOPWATCH

From the normal time mode, press S3 button once, you are now in the chronograph mode.

### First Usage:

- Press S1 button alternately to start and stop the chronograph.
- Press S2 button to reset the chronograph to zero.
- Press S3 button to return to normal time mode. (This can be done at any time with the chronograph still running.)

### Second Usage:

- Press S1 button to start counting.
- Press S2 button to show the first split time T1 (0 to T1). The digits stop flashing, but chronograph is still counting.
- Press S2 button again to continue counting.
- Further press S2 button to show the second split time T2 (0 TO T2). This operation can be repeated and the split times can be read: 0 to T3, 0 to T4 etc.
- Press S1 button to stop the measurement of the chronograph.
- Press S2 button to show the last split time Tn (0 to Tn).
- Press S2 button again, the chronograph is reset to zero.
- Press S3 button to return to the normal time mode.

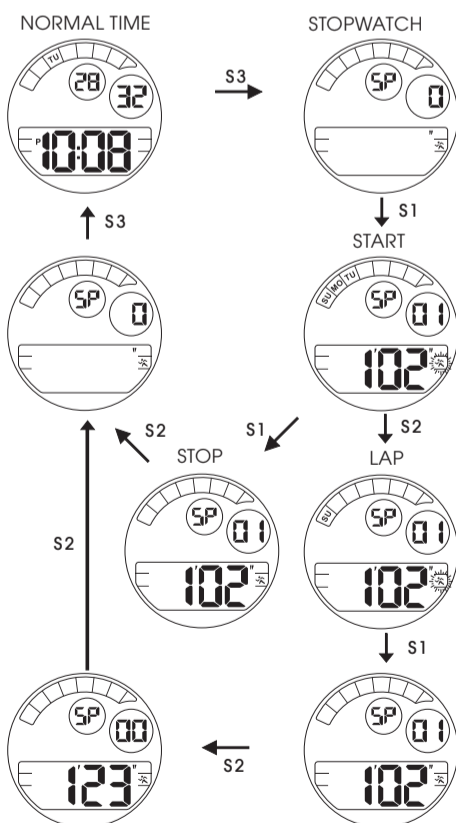

## ■ HOW TO SET ALARM TIME

- You can set alarm with hours and minutes. When the alarm is on, the alarm (BI-BI) sounds for 20 seconds at the preset time. Press S1, S2 or S3 button to stop the alarm after it starts sound. Alarm is available in one time zone only (T1 or T2).
- From the normal time mode, press S3 button 2 times to enter the alarm mode.
- To change the alarm setting, press S2 button. The hour digits start flashing. To adjust the value, press S1 button.
- To move on to the minute setting, press S3 button. To adjust the value, press S1 button.
- To set the time zone, press S3 button. "AL. T1" or "AL. T2" will flash. Select the time zone by pressing S1 button.

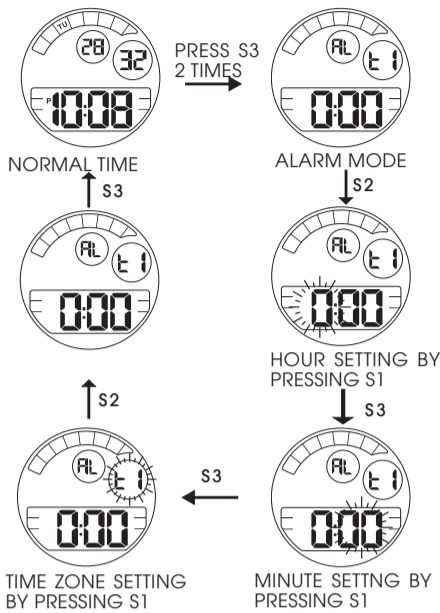

## ■ HOW TO SET SECOND ZONE TIME

- From the normal time mode, press S3 button 4 times to enter the second time zone mode.
- Press S2 button to start the setting procedure. The hour digits start flashing.
- To adjust the value, press S1 button (+1 hour).
- Press S3 button once to move on to the minute setting.
- To adjust the value, press S1 button (+30 minutes or -30 minutes).
- Press S2 button to confirm the setting.
- Press S3 button to return to the normal time mode.

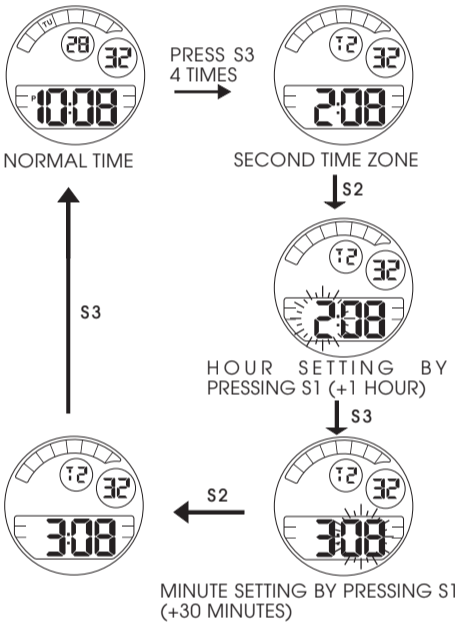

## ■ ALARM & CHIME ON/OFF

From the normal time mode, press S3 button 2 times to enter the alarm mode. Press S1 button to turn on or off the ALARM and HOURLY CHIME signals.

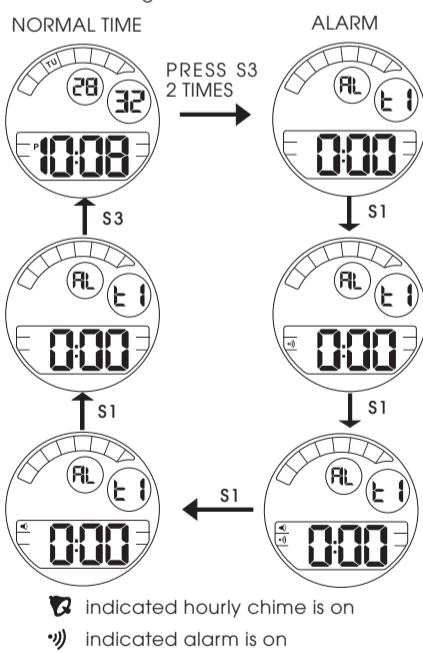

## ■ HOW TO USE EL BACKLIGHT

In any mode press S4 button to illuminate the display for about 3 seconds.

### Note:

- The backlight of the watch employs an electro-luminescent (EL) light, which tends to lose illuminating power after very long use.
- The illumination provided by backlight may be hard to see when viewed under direct sunlight.

## ■ HOW TO USE TIMER

### TO SET THE COUNTDOWN TIMER

- From the normal time mode, press S3 button 3 times to enter the timer mode.
- While in the timer mode, press S2 button. The hour digit starts to flash.
- Press S3 button to change the selection of setting.
- Press S1 button to adjust the value. Holding S1 button down can fasten the process.
- After you set the countdown time, press S2 button to return to the timer mode.

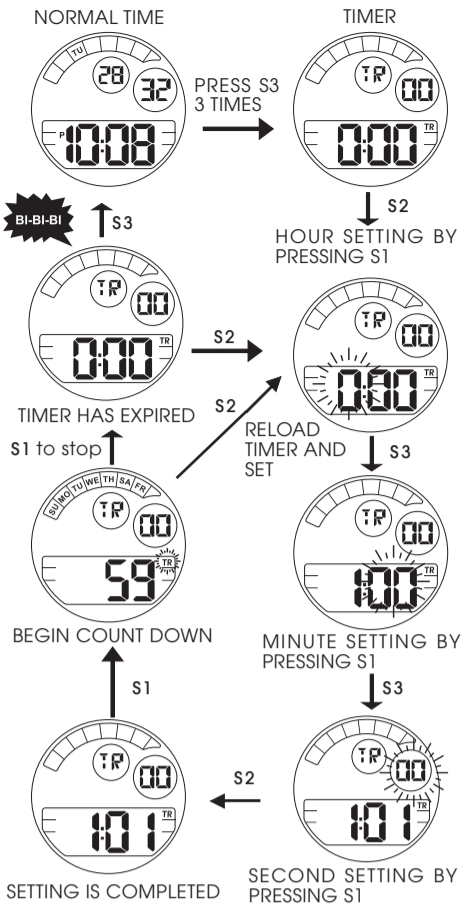

## TO USE THE COUNTDOWN TIMER

- Press S1 button while in the timer mode to start the countdown timer.
- Press S1 button again to stop the countdown timer.
- While in the timer mode, press S2 button to reset the countdown time to its starting value and to start to countdown automatically or while in the timer mode, press S2 button and then press S1 button to reset the countdown time.
- From 3 minutes prior to the expiry time, the alarm (BI BI) beeps each time when the second digits reach "0" or "30".
- Within 10 seconds to the expiry time, the alarm (BI) beeps per second.
- When the timer expires, the alarm (BI-BI-BI) beeps for 10 seconds. It may be silenced by pressing S1, S2 or S3 button.

## ■ BATTERY CHANGE

The batteries which power your watch should last approximately 2 years. However, because they are inserted at the factory, the actual life of the batteries once in your possession may be less than 2 years.

Be sure to replace the batteries to prevent any possible malfunction as soon as they run down. To replace the batteries, we recommend taking the watch to a local watch repair shop.

**Note:** If the alarm is used for more than 20 seconds a day, the hourly time signal more than 24 times a day, the stopwatch more than once a day and/or the illuminating light for more than 1 second a day, the battery life may be less than the specified period.

## ■ CARE OF YOUR LORUS WATCH

This watch contains precise electronic components. Never attempt to open the case or remove the back cover.

### • BATTERY

**CAUTION**

Do not expose the old battery to fire or recharge it. Keep it at a place beyond the reach of children. If a child swallows it, consult a doctor immediately.

### • WATER RESISTANT

Condition of use	Accidental contact with water, such as splashes and rain	Swimming and taking a shower	Skin diving	Scuba diving
Indication on the dial/case back				
No Indication	NO	NO	NO	NO
WATER RESISTANT	YES	NO	NO	NO
WATER RESISTANT (50M/5 BAR)	YES	YES	NO	NO
WATER RESISTANT (100M/10 BAR) or above	YES	YES	YES	NO

\* If your watch is 200 M/20 BAR, 100 M/10 BAR or 50 M/5 BAR water resistant, it is so indicated on the dial/case back.

- Do not operate the buttons when the watch is wet.
- If the watch is exposed to salt water, rinse it in fresh water and then wipe it thoroughly dry.
- Should you find any water or condensation inside the watch, immediately have it checked. Water can corrode electric parts inside the case.

### Caution:

Leather straps are not water resistant except so indicated, even if the watch head is water resistant.

### • ALLERGIC REACTION

Because the case and band touch the skin directly, it is important to clean them regularly. If not, shirt sleeves may be stained and those with delicate skin may develop a rash. Please wear the watch with some play to avoid any possible allergic reaction. If you develop a rash on your wrist, stop wearing and consult a physician.

### • MAGNETISM

Your watch will be adversely affected by strong magnetism. Keep it away from close contact with magnetic objects.

### • SHOCKS AND VIBRATIONS

Your watch may be worn for normal sports activities, but be careful not to drop it or hit it on hard surfaces.

### • TEMPERATURE

Your watch is preadjusted so that constant accuracy may be insured at normal temperature.

### • CLEANING

Use only a soft cloth and clean water for cleaning your watch. Never use chemicals, as the waterproof gasket will corrode.

## ■ SERVICE

When your LORUS watch requires repair or servicing, please see the enclosed WARRANTY/GUARANTEE.