

BUSH

Instruction manual

CD8TDNSW



You'll soon be enjoying your new <condenser dryer>.

It all begins here, with your instructions. Don't worry, there's nothing too technical coming up. Just simple, step-by-step guidance to get you up and running quickly. Sound good? Then let's get started.

Help and Guidance

We're here to help you get the most from your <condenser dryer>. Should you require any guidance, a simple solution can often be found online at:

www.argos-support.co.uk

If you still require further assistance, call one of our experts on **0345 257 7271**.

Contents

1	Safety information		
	Safety information	6	
2	Getting to know your <condenser dryer>		
	Ready? Let's begin	10	
	Accessories	12	
3	Installing your <condenser dryer>		
	Installation requirements	14	
	Electrical connection	15	
4	Functions		
	Functions	18	
5	Using your <condenser dryer>		
	Using your <condenser dryer>	24	
6	Care and Maintenance		
	Cleaning	28	
	Technical specifications	31	
	Product fiche	32	
7	Product support		
	Troubleshooting		34
	Help and assistance		35
	Declaration of conformance to product standards		36
	Disposal		37

Safety information

1





Safety information

Important - Please read these instructions fully before installing or operating

Before use

- The installation of this appliance is best carried out by 2 people.
- Dispose of all packing carefully and responsibly.
- The appliance is designed for **indoor use only** and must be protected from rain, moisture and extreme temperature variations.
- This appliance is designed for household use.
Do not use the appliance for Industrial and commercial use, or any other purpose.
- The appliance **MUST** be positioned on a firm level base.
- **Do not** splash water on the appliance. It may cause electrical parts to fail and result in an electric shock.
- For appliance with ventilation openings in the base, the carpet **must not** obstruct the openings.
- The appliance **must not** be installed behind a lockable door, a sliding door or a door with a hinge on the opposite side to that of the tumble dryer, in such a way that a full opening of the tumble dryer door is restricted.
- **Do not** sit, stand or place any other heavy objects on top of the appliance. This could result in injury or damage to the appliance.
- **Do not** allow children to play with the appliance to avoid the risk of entrapment and suffocation.
- Keep ventilation opening, in the appliance enclosure or in the built-in structure, clear of obstruction.

- The lint trap has to be cleaned frequently, if applicable.
- Clean lint screen before or after each load.
- Never use the dryer without the lint filter.

During use

- This appliance can be used by children aged from 8 years and above and persons with reduced physical, sensory or mental capabilities or lack of experience and knowledge if they have been given supervision or instruction concerning use of the appliance in a safe way and understand the hazards involved. Children shall not play with the appliance. Cleaning and user maintenance shall not be made by children without supervision.
- The tumble dryer is not to be used if industrial chemicals have been used for cleaning.
- Lint must not to be allowed accumulate around the tumble dryer.
- Do not dry unwashed items in the tumble dryer.
- Items that have been soiled with substances such as cooking oil, acetone, alcohol, petrol, kerosene, spot removers, turpentine, waxes and wax removers should be washed in hot water with an extra amount of detergent before being dried in the tumble dryer.
- Items such as foam rubber(latex foam), shower caps, waterproof textiles, rubber backed articles and clothes or pillows fitted with foam rubber pads should not be dried in the tumble dryer.

If you require any technical guidance or find that your product is not operating as intended, a simple solution can often be found in the **Troubleshooting** section of these instructions,



Safety information

Important - Please read these instructions fully before installing or operating

- Fabrics softeners, or similar products, should be used as specified by the fabric softener instructions.
- The final part of a tumble dryer cycle occurs without heat (cool down cycle) to ensure that the items are left at a temperature that ensure that the items will not be damaged.
- Remove all objects from pockets such as lighters and matches.
- **WARNING:** Never stop a tumble dryer before the end of drying cycle unless all items are quickly removed and spread out so that the heat is dissipated.
- Children of less than 3 years should be kept away unless continuously supervised.
- Do not attempt to repair the appliance yourself.
Contact the Customer Helpline:
0345 257 7271.
- If the supply cord is damaged, it must be replaced by the manufacturer, its service agent or similarly qualified persons in order to avoid a hazard.
- Oil-affected items can ignite spontaneously, especially when exposed to heat sources such as in a tumble dryer. The items become warm, causing an oxidation reaction in the oil. Oxidation creates heat. If the heat cannot escape, the items can become hot enough to catch fire. Piling, stacking or storing oil-affected items can prevent heat from escaping and so create a fire hazard.
- If it is unavoidable that fabrics that contain vegetable or cooking oil or have been contaminated by hair care products be placed in a tumble dryer they should first be washed in hot water with extra detergent - this will reduce, but not eliminate, the hazard.



CAUTION: HOT SURFACE!



CAUTION: RISK OF FIRE!

Getting to know your
<condenser dryer >

2



Getting to know your < condenser dryer >

You'll be up and running in no time

Ready? Let's begin...

Please read these instructions carefully. They contain important information which will help you get the best from your <condenser dryer> and ensure safe and correct installation and operation.

If you require any further assistance, our technical experts are happy to help. For full details, refer to the product support section at the end of these instructions.

If you require any technical guidance or find that your product is not operating as intended, a simple solution can often be found in the **Troubleshooting** section of these instructions.

Getting to know your < condenser dryer >

You'll be up and running in no time

Component

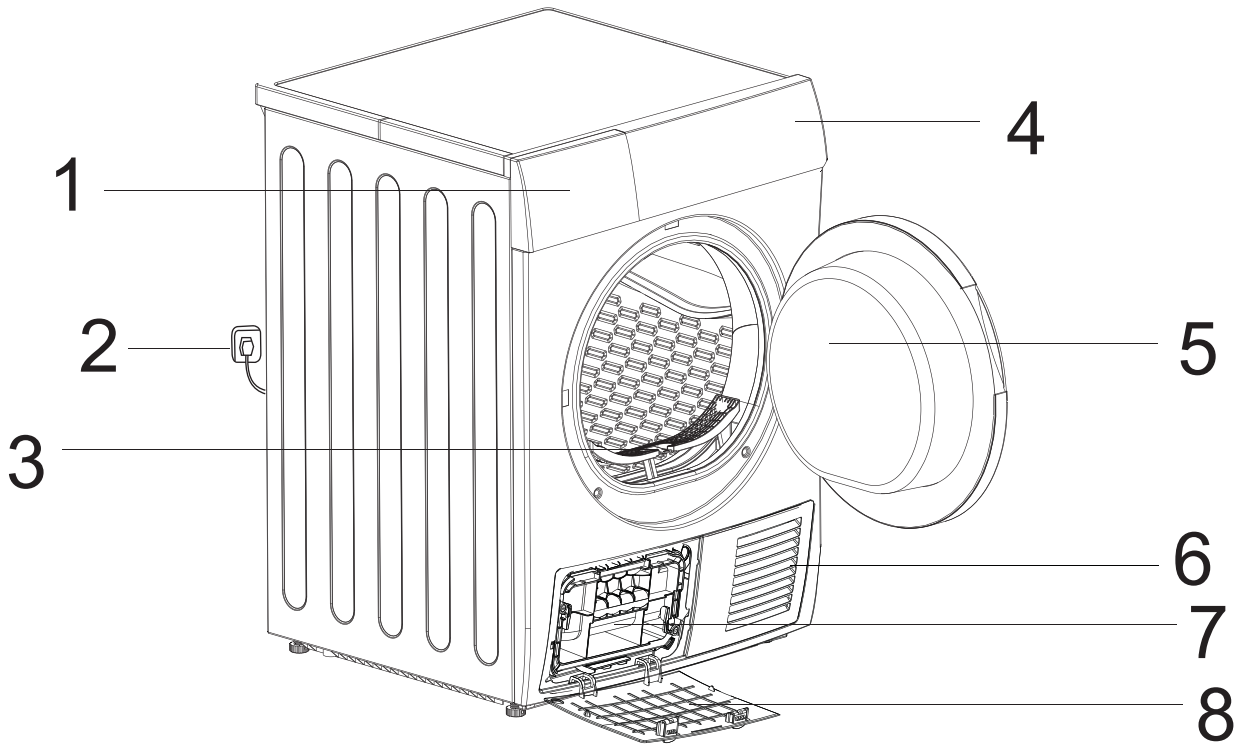

1. Water Container

2. Power Cord & Plug

3. Lint filter

4. Control Panel

5. Door

6. Air inlet

7. Condenser Unit

8. Condenser Cover

Getting to know your < condenser dryer >

You'll be up and running in no time

Model	capacity	Energy class	Color
CD8TDNSW	8kg	B	White

Accessories

This machine includes below accessories

- Instructions X 1



Tools

You may use this tools to help install above parts

- glove
- screwdriver

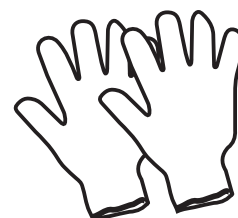
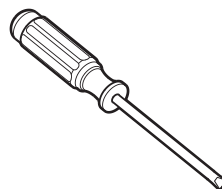

If you require any technical guidance or find that your product is not operating as intended, a simple solution can often be found in the **Troubleshooting** section of these instructions,

Installing your < condenser dryer>

3



Installing your < condenser dryer >

Bringing it all together

Installation requirements

Transportation

-  Caution: 2 people are required to unpack and handle the appliance, it is recommended that gloves are worn.
- The appliance should be transported only in an upright position. Do not tilt the appliance greater than 45°. The packaging as supplied must be intact during transportation.
- Do not move the appliance by pulling the door or handle as it may damage your flooring and wall coverings etc.
- Ensure the supply cable is not caught under the appliance during and after moving.
- Carefully remove all package materials including the foam base, dispose of correctly.

Unpacking condenser dryer

Caution: 2 people are required to unpack the tumble dryer, it is recommended that gloves are worn.

Carefully remove all packaging materials including the foam base, dispose of correctly.

Installation

- Please install the dryer on solid and flat ground.
- Please do not place the dryer on the slope, soft carpet or wooden floor.
- Please do not install the dryer outdoors, to prevent the dryer from being frozen to damage of machine parts.
- If the floor is obviously uneven, it needs to be adjusted. It vibrates the machine, causing machine to move from its position. Using tools to adjust the height of four machine legs to adjust the levelness of this dryer.(Fig1)

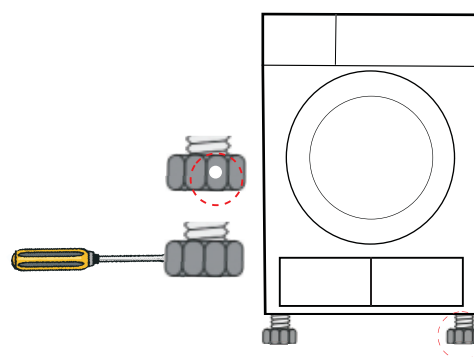

Fig 1

If you require any technical guidance or find that your product is not operating as intended, a simple solution can often be found in the **Troubleshooting** section of these instructions.

Installing your < condenser dryer >

Bringing it all together

Electrical connection



Any electrical work that is required to install this appliance **MUST** be carried out by a qualified electrician.



Warning: THIS APPLIANCE MUST BE EARTHED

Before making any electrical connections, ensure that:

- Electrical safety is only guaranteed when the earth system of your house in accordance with the related local regulations.
- Do not bend, stretch or pull the supply cable to avoid electric shock.
- Ensure the power socket is suitable for the Maximum power of the machine (fuses in the power circuit must be 13 amp).
- The supply voltage should be the same as that indicated in the technical specifications and the appliance rating plate.
- The appliance should be earthed and in compliance with the applicable law.
- When installed, the power socket must be within easy reach.
- If the socket outlets in your home are not suitable for the plug supplied with this unit check with a qualified electrician for replacement.
- To avoid the risk of overloading your plug socket, the use of adapters, multiple connectors or extension cables are not recommended. The appliance must be connected to a 220-240 volt 50Hz AC supply by means of a three pin socket, suitably earthed and protected by a 13 amp fuse.
- Should the fuse need to be replaced, a 13 amp fuse approved to BS1362/A must be used.
- The plug contains a removable fuse cover that must be refitted when the fuse is replaced. If the fuse cover is lost or damaged, the plug must not be used until a replacement cover has been fitted or the plug is replaced.
- A damaged plug should be cut off as close to the plug body as possible, the fuse should be removed and the plug disposed of safely.

Plug replacement (UK & Ireland only)

Should you need to replace the plug; the wires in the power cable are coloured in the following way:

Blue - Neutral ' N '

Brown - Live ' L '

Green & Yellow - Earth ' E '

As the colours of the wires in the power cable may not correspond with the coloured markings identifying the terminals in your plug, and proceed as follows (Fig2):

The green & yellow wire must be connected to the terminal in the plug that is marked with the letter E or by the earth symbol.

The blue wire must be connected to the terminal that is marked with the letter N.

The brown wire must be connected to the terminal that is marked with the letter L.

If power supply cord is damaged, it must be replaced by the manufacturer or its service agent or a similar qualified person in order to avoid a hazard.

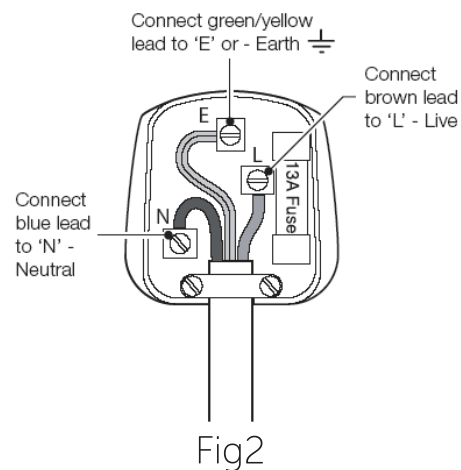

Functions 4



Functions

Simple everyday use

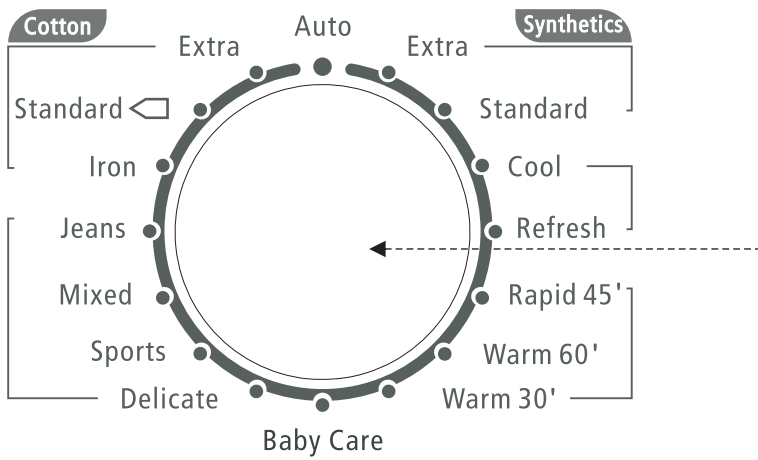

Programme selection knob
For you to select different dry programme

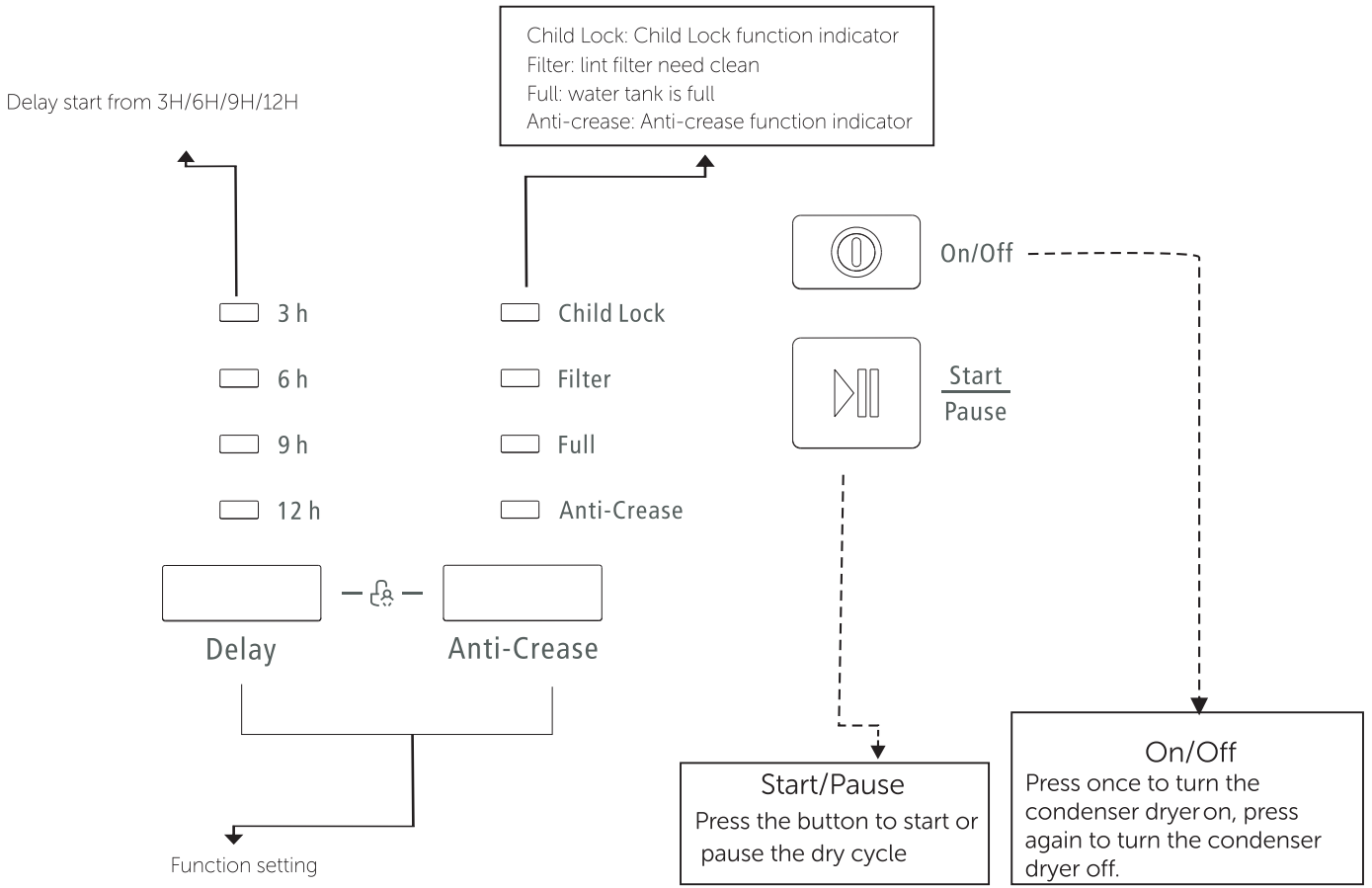

Press function button, function icon will be activated.
After programme started, press Delay and Anti-crease button simultaneously for 3 sec to indicate Child Lock function

If you require any technical guidance or find that your product is not operating as intended, a simple solution can often be found in the **Troubleshooting** section of these instructions.

Functions

Simple everyday use

Select the programme

1. Press the **[On/Off]** button ,when the LED brighten up, rotate the programme knob to select the desired programme.
2. Select the **[Delay]**, **[Anti-Crease]** functions for additional option.
3. Press the **[Start/Pause]** button.

Programme start

The drum will keep rotating after the programme start, the state light will flash in sequence.

Programme end

The drum will stop running after the programme ends.
The dryer will start **[Anti-crease]** function if user doesn't remove the load in 1 minute (refer to page 21). Please press **[On/Off]** key to cut off power.

Cotton

For cottons and coloureds made of cotton or linen.

Rapid 45'

For washing which is to be dried quickly, eg, made of acrylic fibres or for individual small items.

Synthetics

For non-iron washing made of synthetic and blended fabrics, cotton.

Baby Care

To dry the clothes of the baby.

Special

To dry delicate clothes in a low temperature.

Delicate

Define and save your favorite programme.

Warm - To warm clothes 30 min or 60min.

Cool - To air clothes without blowing hot air.

Refresh - To refresh the clothes that have been kept at closed environments for a long time.

Auto- Special programme which can work automatically for mixed of different kind of clothes.
Not suitable for wool.

Functions

Simple everyday use

Specialty drying function

1. **【Delay】** drying procedure

To delay the drying programme 3H,6H,9H,12H. this function can start the machine after the set time.

Steps in details

- (1).Load your laundry and make sure the machine door is closed.
 - (2).Press the **【On/Off】** button,then to turn the programme selector knob and select a desired programme.
 - (3).You can select the **【Anti-Crease】** functions according to your need.
 - (4).To press the **【Delay】** key.
 - (5).Continue to press the **【Delay】** to select the delay time.
 - (6).After the **【Start/Pause】** button is pushed, the dryer is at the run condition. The drying procedure will be automatically performed when the delay time is over.
 - (7).If you push the **【Start/Pause】** button again, the delay function will be paused.
 - (8).If you want to cancel the "Delay" function, please press the **【On/Off】** button.
- Example: Select **【Cotton extra】** programme to start up on 3 hours later.
Select **【Cotton extra】** and **【Delay】**,then press **【Delay】** button until display show "3H", then press **【Start/pause】**,the dryer will perform automatically after 3 hours.

If you require any technical guidance or find that your product is not operating as intended, a simple solution can often be found in the **Troubleshooting** section of these instructions.

Functions

Simple everyday use

1. **【Anti-Crease】**function

At the end of the drying cycle, it will display end for 1 min. Then it will automatically launch the anti-crease operation for 30 minutes. If this function has been selected, the anti-crease operation will be lasted for 120 minutes. You can stop this function at any time when you press the start/pause button once.

The **【Anti-Crease】**indicator shall illuminate when the anti-crease function is selected.

This function prevents the laundry from creases. The laundry can be removed during the anti-crease phase.

2. **【Child Lock】** feature

(1).This machine incorporates a special child safety lock, which can prevent children from carelessly pressing keys or making the faulty operation.

(2).When the dryer is at the operation state, press the**【Anti-Crease】**and **【Delay】**buttons at the same time for over 3 seconds to start child lock function. When child lock function is set, no key can effect to the dryer except **【On/Off】**button. Under child lock mode, press the **【Anti-Crease】**and **【Signal】**buttons at the same time for over 3 seconds to release the child lock function.

3. Once programme has started

- Changing the program

Press **【on/off】**, the machine will stop running. Then press **【on/off】** again, you can choose another program which you prefer. Then press **【start/pause】**, the machine will continue to work under the new programme.

- Cancelling the programme

Open the door, the unit will stop immediately. Press on/off once to switch off unit and cancel the programme at the same time.

- Add or remove laundry

Open the door, the machine will stop running, you can add or remove laundry then press **【start/pause】**, the machine will continue to work.

Functions

Simple everyday use

Programme table

Programme		Weight (max)	Application/Properties
Auto	Auto	5.0kg	To dry unknown material clothes automatically.
Cotton	For cottons and coloureds made of cotton or linen.		
	Extra	8.0kg	To dry cotton pieces of clothing. Drying level: extra dry.
	Standard	8.0kg	To dry cotton pieces of clothing. Drying level: cupboard dry.
	Iron	8.0kg	To dry cotton pieces of clothing. Drying level: applicable to iron.
Jeans	Jeans	5.0kg	To dry jeans or leisure clothes that are spun at high speeds in the washing machine.
Mixed	Mixed	3.5kg	If you can not determine what the clothing's material is, please choose Mix.
Sports	Sports	3.0kg	To dry sportswear, thin fabrics, polyester, which are not ironed.
Delicate	Delicate	1.0kg	To dry delicate laundry that is suitable for drying or laundry which is advised to be hand-washed at a lower temperature.
Baby Care	Baby Care	1.0kg	To dry small amount of baby clothing.
Synthetics	For non-iron washing made of synthetic and blended fabrics, cotton.		
	Extra	3.5kg	To dry thick or multi-layered synthetic fabrics. Drying level: extra dry.
	Standard	3.5kg	To dry thin synthetic fabrics which are not ironed, such as easy care shirts, table linen, baby clothes, socks.
Cool	Cool	—	To air clothes without blowing hot air from in 10 min.
Refresh	Refresh	—	To refresh the clothes that have been kept at closed environments for a long time from minimum 20 min. to maximum 150 min. (in 10 min. steps).
Rapid 45'	Rapid 45'	0.6kg	To dry at most 3 shirts in 45 min.
Warm 60'	Warm 60'	—	To warm clothes with hot air in 60 min.
Warm 30'	Warm 30'	—	To warm clothes with hot air in 30 min.

Note:

1.  This symbol means the energy efficiency test programme "standard cotton programme", which is most suitable to dry normal cotton load at rated load capacity

2. The programme above are only recommended for using, users can choose the appropriate programme according to the personal habits. Thick and multi-layered fabrics, e.g. bedlinen, jeans, jackets etc, are not easy to dry, you'd better choose Jeans programme and maximum drying intensity level.

If you require any technical guidance or find that your product is not operating as intended, a simple solution can often be found in the **Troubleshooting** section of these instructions.

Using your < condenser dryer >

5



Using your < condenser dryer >

Getting the most from your appliance

Before first use

Final checks before operating the appliance

1. Good air circulation around the appliance positioned appliance.
2. The feet have been adjusted for perfect leveling.
3. Plug in the appliance.

Garments suitable for drying in tumble dryer

Before using the tumble dryer, you have to ensure the laundry is suitable to dry in the tumble dryer. Always follow the advice on the garment labels. Dry only laundry with a label stating they are suitable for drying in the dryer and select the appropriate programme.

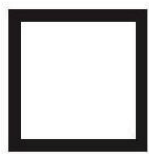

Dry



Do not dry



Do not tumble dry



Tumble dry, high heat



Tumble dry, middle heat

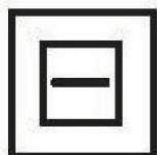

Dry horizontally



Hang without spinning



Dry on a hanger

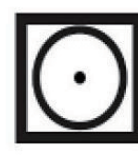

Tumble dry, low heat

Garment NOT suitable for drying in tumble dryer

- Do not dry articles that have been previously cleaned in, washed in, soaked in or spotted with Petrol,/gasoline, dry-cleaning solvents or other flammable or explosive substances as they give off vapors that could ignite or explode.
- Do not dry the articles containing rubber, plastic or similar elastic materials such as padded bras, tennis shoes, galoshes, bath mats, rugs, bibs, baby pants, raincoat plastic bags or pillows that may melt or burn. Some rubber materials, when heated, can under certain circumstances produce fire by spontaneous combustion.
- Do not dry clothes / articles made of foam or rubber as they may be deformed.
- Clothes / articles made of containing meal, hard plastic and similar materials, such as belt buckles, jeans, bra wires, buttons and similar accessories will damage the machine and may cause breakdown.
- Do not place such items in the tumble dryer.
- Do not dry items such as woolen, silk articles and nylon stockings, delicate embroidered fabrics, garments with metal accessories and items such as sleeping bags.
- Too wet laundry or laundry with dripping water must not be put into the tumble dryer.

Preparation for the clothes to be dried

- Thoroughly spin the laundry in washing machine. High spin speed can reduce the drying time and save energy consumption.
- Separate your laundry before placing them into the tumble dryer.
- Sort the laundry according to their types thickness. Put the same type of laundry together.

If you require any technical guidance or find that your product is not operating as intended, a simple solution can often be found in the **Troubleshooting** section of these instructions.

Using your < condenser dryer >

Getting the most from your appliance

Quick start

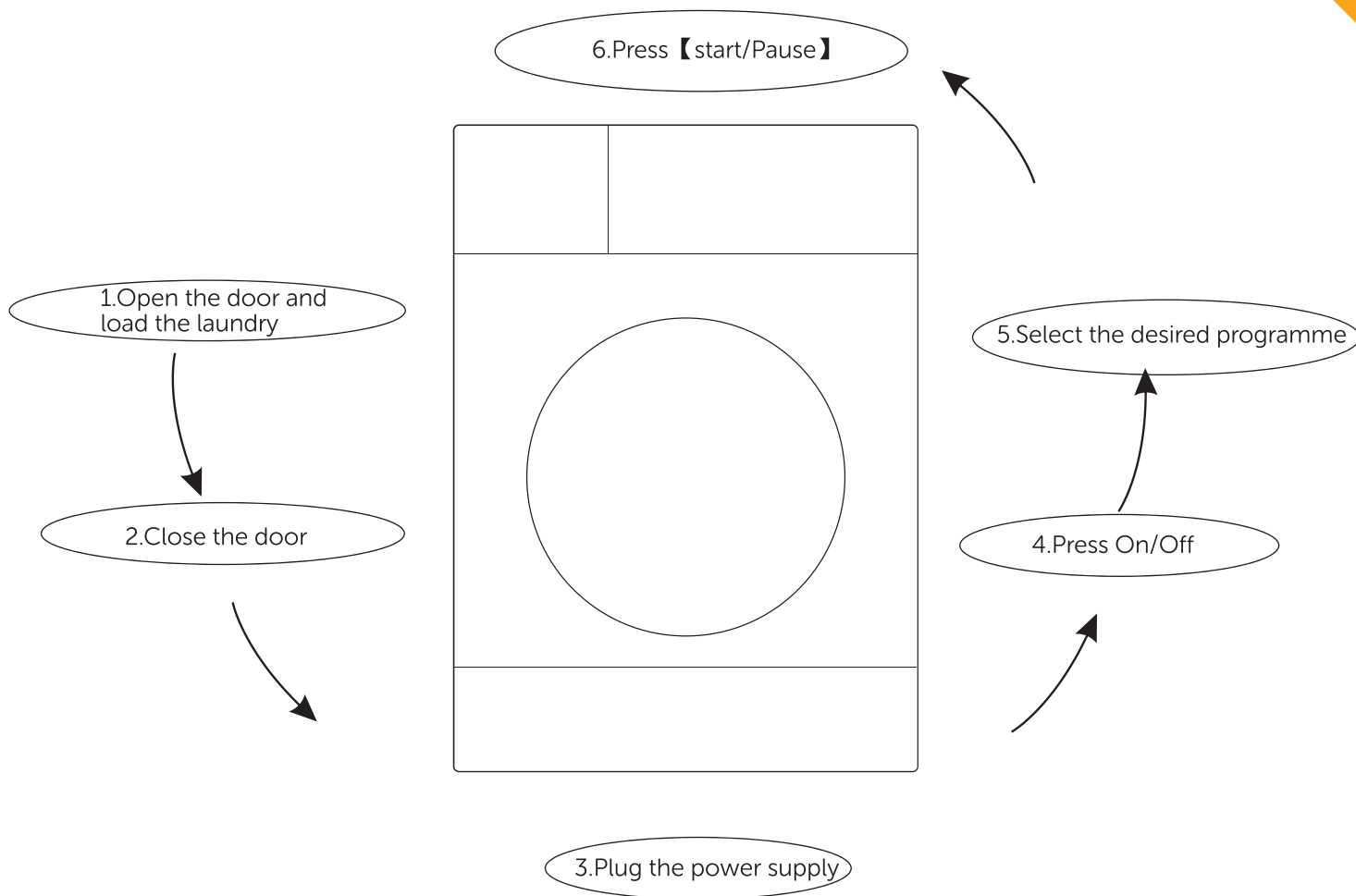

Care and maintenance

6



Care and maintenance

Looking after your appliance

General



Important: Always unplug the appliance from the power socket during cleaning and maintenance.

- Never use any sharp instruments or abrasive substance, soap, household cleaner, detergent or wax polish for cleaning.
- Use luke warm water to clean the cabinet of the appliance and wipe it dry.
- Never clean the appliance with flammable fluids. It could cause a damage and fire hazard.
- Clean the exterior of the appliance, inner tube and door seal with a damp cloth. Open the door for aeration to dry the inner tube through.
- Avoid water going in the control panel. Clean with a dry cloth only.
- Clean the lint filter after each use.

NOTE!

- 1.The lint filter accumulated on the filter will block the air circulation, which will cause the extension of drying time and consumption; therefore, the scrap thread filter shall be cleaned after each use.
- 2.Do not operate the dryer without the lint filter !
- 3.Clean the lint filter after each use to prevent lint accumulation inside the dryer.
- 4.The icon  will flash to remind you to clean the filter.

Cleaning the door

Periodically clean the interior part of the door to remove any fluff from the seals around the filter. Accurate cleaning ensures correct drying(Fig4).

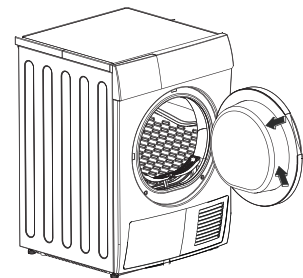

Fig4

Cleaning the filter:

- 1.Open the loading door.
- 2.Remove the cover filter by pulling it up and open the filter (Fig5,6)
- 3.Clean lint,fibre,and cotton raveling by hand or with a soft piece of cloth (Fig7,8).
- 4.Close the filter and place it back into its seat.

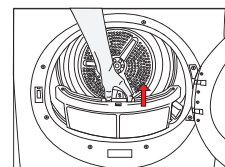

Fig5

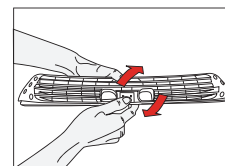

Fig6

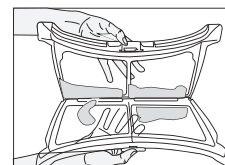

Fig7

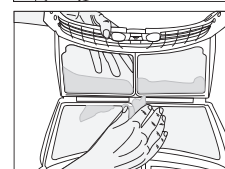

Fig8

NOTE!

Do not be alarmed by the amount of fluff. It is not due to excessive wear caused by the dryer.

All fabric loses fluff when drying but it goes unnoticed in the air. In a tumble dryer it simply collects in the filter.

After a while, a whitish film due to detergent residue on laundry forms on the filters. When this occurs, clean the filters with warm water using a brush.

If you require any technical guidance or find that your product is not operating as intended, a simple solution can often be found in the **Troubleshooting** section of these instructions.

Care and maintenance

Looking after your appliance

Cleaning the condenser

- ⚠ 1.Clean with water only; do not use hard/sharp-edged objects!
Do not operate the dryer without the air condenser!
- 2.During drying, water may collect between the window and the seal, but this does not affect the function of your dryer!

The condenser is situated at the lower part of the cabinet behind a small door. To open the door, push the catch as per picture above. During the drying cycle or at the end, it is normal for water to be present on the surface of the condenser unit(Fig9).

To pull out the condenser, first turn the two red stops downwards and then remove the condenser unit holding it at the handle(Fig10).

Clean it with a brush and rinse it under the shower if necessary(Fig11). Also clean the outside, removing all fluff. Clean the rubber seal round the condenser cabinet and in the inner part of the small door with a damp cloth.

- ⚠ Important! Do not use pointed objects or utensils to clean the spaces between the plates, as this could damage the condenser and make it permeable. Re-fit the condenser, turn the red stops upwards and close the door.

- ⚠ Do not use this appliance if the condenser has not been fitted.

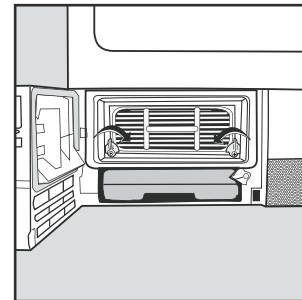

Fig9

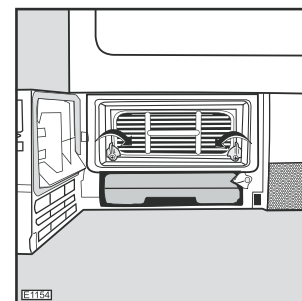

Fig10

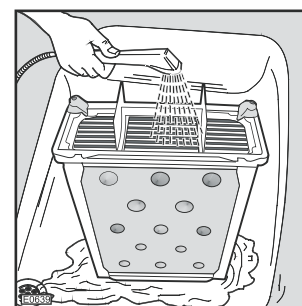



Fig11

Care and maintenance

Looking after your appliance



WARNING:

1. Empty the water container after each use, the programme will be paused and the “” icon will flash if the water container is full during the drying process. After the container is empty, the dryer can be restarted by pressing **【Start/Pause】** button.
2. Do not drink the condensed water.
3. Do not use the dryer without the water container.

Empty the water container

1. Hold and pull out the water container with two hands (Fig12).
2. Tilt the water container, pour out the condensed water (Fig13).
3. Insert the water container.

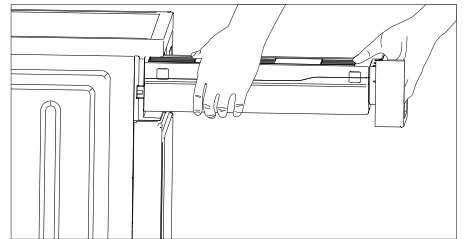

Fig12

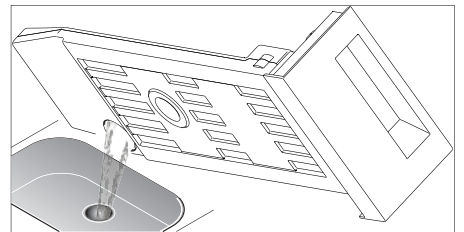

Fig13

The tank must be re-inserted correctly.

After emptying and inserting the tank the Start/Pause button has to be pressed again to allow the programme to continue.

Cleaning the drum

When your laundry does not reach the desired degree of dryness, in other words, when it turns out either too dry or too damp, we advise you to clean the inside of the drum with a cloth soaked with vinegar.

This will eliminate the slight film that has formed in the drum (due to residues of detergent and softeners used in the washing, and from the lime contained in the water), which prevents the probes from detecting the correct degree of dryness.

If you require any technical guidance or find that your product is not operating as intended, a simple solution can often be found in the **Troubleshooting** section of these instructions.

Care and maintenance

Looking after your appliance

Technical specification

Model	CD8TDNSW
Energy efficiency class 1	B
Energy consumption – pre year 2	561kWh
Rated capacity (max.)	8kg
Operating noise level dB(A)	69
Product dimension	H845xW595xD615
Net Weight	41kg
Rated power input	2700W
Rated voltage/Frequency	220-240V~/50Hz
Minimum operation temperature	+5°C

- The rated capacity is the maximum capacity, make sure that the dry clothes which are loaded to the appliance do not exceed the rated capacity each time.
- Do not install the tumble dryer in a room when there is a risk of frost occurring. At temperatures around freezing point the tumble dryer may not be able to operate properly.
- There is a risk of damage if the condensed water is allowed to freeze in the pump, hoses and / or condensed water container.

NOTE:

1 A+++ (most efficiency) to D (least efficiency)

2 Energy consumption 561.0kWh per year, based on 160 drying cycles of the standard cotton programme at full and partial load, and the consumption of the low-power modes. Actual energy consumption per cycle will depend on how the appliance is used.

We apologise for any inconvenience caused by any minor inconsistencies in these instructions, which may occur as a result of product improvements and development.

Care and maintenance

Looking after your appliance

Product fiche

Brand	BUSH
Model	CD8TDNSW
Dryer Type	Condenser
Rated capacity	8 kg
Energy efficiency class	B
Energy consumption	561 kWh
Automatic or non-automatic	Automatic
EU Ecolabel	N/A
Energy consumption of the standard cotton programme at full load	4.74 kWh
Energy consumption of the standard cotton programme and partial load	2.56 kWh
Power consumption of the off-mode (Po)	0.28 W
Power consumption of the left-on mode (PI)	0.8 W
Duration of the left- on mode	10 min
Weighted programme time of the standard cotton programme at full and partial load	112 min
Programme time of the standard cotton programme at full load	140 min
Programme time of the standard cotton programme at partial load	90 min
Sound power level for the standard cotton programme at full load	69 dB
Average condensation efficiency of the standard cotton programme at full load	80.1%
Average condensation efficiency of the standard cotton programme at partial load	80.1%
Weighted condensation efficiency for the standard cotton programme at full and partial load	80.1%
The 'standard cotton programme' used at full and partial load is the standard drying programme to which the information in the label and the fiche relates, that this programme is suitable for drying normal wet cotton laundry and that it is the most efficient programme in terms of energy consumption for cotton.	

NOTE:

1 A+++ (most efficiency) to D (least efficiency)

2 Energy consumption 561.0 kWh per year, based on 160 drying cycles of the standard cotton programme at full and partial load, and the consumption of the low-power modes. Actual energy consumption per cycle will depend on how the appliance is used.

We apologise for any inconvenience caused by any minor inconsistencies in these instructions, which may occur as a result of product improvements and development.

If you require any technical guidance or find that your product is not operating as intended, a simple solution can often be found in the **Troubleshooting** section of these instructions.

Product support

7



Product support

Help is always at hand

Troubleshooting

1. Tumble dryer doesn't operate?

Please make sure the power plug was inserted well and check the protection devices and fuses.

2. Laundry has shrunk?

Please review the advice on the garments label to select the suitable programme setting.

3. Laundry not dry enough at the end of drying?

Please reduce the quantity of clothes for drying each time and clean the lint filter after each use.

4. Laundry too dry?

Please take out the clothes immediately while the drying cycle is finished and review the advice on the garments label to select the suitable programme setting.

5. The tumble dryer has noisy?

Please make sure the tumble dryer was installed on even surface and leveling the appliance.

6. is flashing?

Please empty condensation container.

7. is flashing?

Please clean air cooler and lint filter.

If you require any technical guidance or find that your product is not operating as intended, a simple solution can often be found in the **Troubleshooting** section of these instructions.

Product support

Help is always at hand

Help and assistance

If you require any technical guidance or find that your <condenser dryer> is not operating as intended, a simple solution can often be found in the **Troubleshooting** section of these instructions or online at www.argos-support.co.uk

If you still require further assistance, call one of our experts on **0345 257 7271*** To help give us give you a fast and efficient service please have the following information ready:

Model Ref.	<input type="text"/>	You can find these on the rating plate - a small information panel (usually a sticker or metal plate) on the rear of your appliance
Serial number	<input type="text"/>	
Date of purchase	<input type="text"/>	This will be shown on your receipt

Local call rates applies*

Lines open 8am-7pm Monday to Saturday and 10am-4pm Sunday.

*Calls to Argos enquiry lines may attract a charge and set up fee from residential lines depending on your call plan/tarif. Mobile and other providers costs may vary, see www.bt.com/pricing for details.

For Security and training purposes, telephone calls to and from customer service centres maybe recorded and monitored. Calls from Republic of Ireland will attract international call charges.

or online at www.argos-support.co.uk If you still require further assistance, call one of our experts on **0345 257 7271**.

Product support

Help is always at hand



This appliance complies with the following EEC directives:

2014/35/EU low voltage directive

2014/30/EU EMC directive

2009/125/EC EU Directive

Notes on disposal:



This marking indicates that this product should not be disposed with other household wastes throughout the EU. To prevent possible harm to the environment or human health from uncontrolled waste



disposal, recycle it responsibly to promote the sustainable reuse of material resources. To return your used device, please use the collection systems or contact the retailer where the product was purchased. They return and can take this product for environmental safe recycling.

Remember: Old machine must be disposed of carefully – Cut off the mains plug and /or remove the door to be unusable before disposed – if in doubt, contact your local council for details on how to dispose of an old dryer.

If you require any technical guidance or find that your product is not operating as intended, a simple solution can often be found in the **Troubleshooting** section of these instructions.

Product support

Help is always at hand



Call us now and activate your 12 month guarantee

Thank you for choosing Bush. Your new product is guaranteed against faults and breakdowns for 12 months. Don't forget to register it with us today so we can provide you with our best possible after-sales service and useful updates.

www.bushregistration.co.uk

FREEPHONE*

0800 597 8548

Lines are open 8am - 8pm, 365 days a year. *Calls may be recorded and monitored.

Your Bush Guarantee

This product is guaranteed for twelve months from the date of original purchase. Any defect that arises due to faulty materials or workmanship will be repaired free of charge (or if applicable the product will be replaced or the purchase price refunded) where possible during this period by the dealer from who your purchased the unit.

The guarantee is subject to the following provisions:

- The guarantee does not cover accidental damage, misuse, cabinet parts, knobs or consumable items.
- The product must be correctly installed and operated in accordance with the instructions contained in the manual.
- It must be used solely for domestic purposes. The guarantee will be rendered invalid if the product is re-sold or has been damaged by inexpert repair.
- Specifications are subject to change without notice.
- Bush disclaim any liability for loss or damage arising from the breakdown of the product.
- This guarantee is in addition to and does not diminish your statutory or legal rights.

Important Data Protection Information

If you provide us with information about another person, you confirm that they have appointed you to act for them, to consent to the processing of their personal data including sensitive personal data and that you have informed them of our identity and the purposes (as set out in the Important Data Privacy notice displayed overleaf) for which their personal data will be processed.

You are entitled to ask for a copy of the information we hold about you (for which we may charge a small fee) and to have any inaccuracies in your information corrected.

For quality control and training purposes, we may monitor or record your communications with us.

If your personal details change, if you change your mind about any of your marketing preferences or if you have any queries about how we use your information, please let us know by contacting our Data Protection Officer, Domestic & General, Leicester House 17 Leicester Street, Bedworth, Warwickshire CV12 8JP.

Guarantor: Argos Limited - 489 - 499 Avebury Blvd. - Milton Keynes - MK9 2NW

or online at www.argos-support.co.uk If you still require further assistance, call one of our experts on 0345 257 7271.

BUSH

Contact:

www.argos-support.co.uk

Helpline: 0345 257 7271