

BUSH

Instruction Manual

PR-50



Table of content

Help and guidance	1
Safety information	2
Battery installation	2
Functions & Control	3
Setting the clock	4
Turning on/off the radio	4
Listening to radio	4
Locking function	5
Presetting your favourite radio stations	5
Specification	5
Product support	6
Disposal	7
Guarantee	7
Important Data Protection information	8

You'll soon be enjoying your new Personal FM Radio.

It all begins here, with your instructions. Don't worry, there's nothing too technical coming up. Just simple, step-by-step guidance to get you up and running quickly. Sound good? Then let's get started.

Help and Guidance

We're here to help you get the most from your radio. Should you require any guidance, a simple solution can often be found online at:

www.argos-support.co.uk

If you still require further assistance, call one of our experts on **0345 604 0105**.



Safety Information

Important – Please read these instructions fully before installing or operating

- This appliance is intended for domestic household use only and should not be used for any other purpose or in any other application, such as for non-domestic use or in a commercial environment.
- Ventilation
- Allow at least a 10 cm gap all around the product.
- The ventilation should not be impeded by covering the ventilation openings with items, such as newspapers, table-cloths, curtains, etc.
- No naked flame sources, such as lighted candles, should be placed on the apparatus.
- Attention should be drawn to the environmental aspects of battery disposal.
- This apparatus is not suitable for use in a tropical climate.
- The apparatus shall not be exposed to dripping or splashing and that no objects filled with liquids, such as vases, shall be placed on the apparatus.
- Batteries (battery pack or batteries installed) shall not be exposed to excessive heat such as sunshine, fire or the like.
- Never let anyone push objects into holes and ventilations slots.
- Do not attempt to repair this product yourself; always get a qualified service agent carry out adjustments or repairs.
- The marking plate is located at the rear of the apparatus.

INSTALLING THE BATTERIES

- Only adults should handle battery. Do not allow a child to use this apparatus unless the battery cover is securely attached to the unit.
- Insert 2 x 1.5V AAA size batteries (not included) in to the compartment, taking care to match the battery orientations marked on the inside of the





compartment.

- Replace the battery compartment cover.

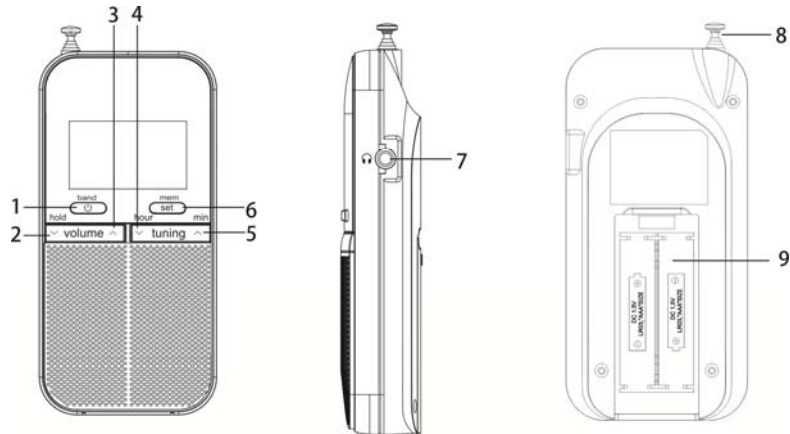
Important: You need to reset the clock and the preset stations when inserting new batteries.

FUNCTIONS & CONTROL



1.  /band button
2. Volume  /hold button
3. Volume  button
4. Tuning  / hour button
5. Tuning  / min button

6. Set/mem button
7.  headphones/earphones jack
8. Telescopic antenna
9. Battery compartment



To prevent possible hearing damage, do not listen at high volume levels for long periods.

SETTING THE CLOCK



After inserting the batteries, the hour and minute digits “0:00” will flash on the display. In this standby state you can set the clock.

1. Repeatedly press **hour/min** to set the clock time.
2. Press **set** to confirm.
 - The hour and minute digits will stop flashing.
 - “:” will flash.





To reset the clock, in standby state press and hold **set** until the clock time flashes and then repeat the steps above to set the clock time.

TURNING ON/OFF THE RADIO

1. Press  to turn on the radio.
 - The display will briefly show the radio frequency and then return to the clock time.
2. To turn off the radio, press and hold  for about 2 seconds.

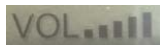
LISTENING TO RADIO

1. In power on state, repeatedly press **band** to select the radio frequency AM or FM.
 - The corresponding band symbol “FM” or “AM” will appear on the display.
2. Adjust the volume by repeatedly pressing the volume up and down buttons. 
 - The display will show the volume level 
3. Repeatedly press the tuning up and down buttons to tune into the desired station. 
 - Press and hold the tuning up or down button for auto forward or backward radio station searching.

NOTE:

- For the best FM reception, extend the telescopic antenna to its full length, adjust the direction and angle.
- For the best AM reception, rotate the apparatus slowly and horizontally.

Locking function

When turning on the radio, you can lock all buttons to prevent settings from being changed accidentally.



To lock the buttons, press and hold the button  for about 5 seconds and the display will show "HOLD".

To unlock the buttons, press and hold this button again for about 5 seconds and "HOLD" will disappear from the display.

NOTE: This locking function is only available when turning on the radio.

PRESETTING YOUR FAVOURITE RADIO STATIONS

Up to 10 FM and 10 AM radio stations can be preset.

1. Follow steps in "Listening to Radio" and tune in to the station that you wish to preset.
2. Press and hold **mem** for about 2 seconds.
 - The display will show "PRESET".
3. While "PRESET" is displayed, press **mem** again to store the station.
4. Repeat steps above to store desired stations.

To listen to preset radio stations, repeatedly press **mem** to select the desired radio station. The display will show "MEM" and "CH" number.

SPECIFICATIONS

FM: 87.5 MHz – 108 MHz

AM: 522 KHz – 1620 kHz

Power Output: 0.3W RMS

Power source: DC 3V (2 x 1.5V  SIZE "AAA")

We apologise for any inconvenience caused by minor inconsistencies in these instructions, which may occur as a result of product improvement and development.

Product support

Help is always at hand

Help and assistance

If you require any technical guidance or find that your Alarm Clock Radio is not operating as intended, a simple solution can often be found in the Troubleshooting section of these instructions or online at

www.argos-support.co.uk

If you still require further assistance, call one of our experts on
0345 604 0105.

Local call rates applies*

Lines open 8am-7pm Monday to Saturday and 10am-4pm Sunday.

*Calls to Argos enquiry lines may attract a charge and set up fee from residential lines depending on your call plan/tariff. Mobile and other providers costs may vary, see www.bt.com/pricing for details.

For Security and training purposes, telephone calls to and from customer service centres maybe recorded and monitored. Calls from Republic of Ireland will attract international call charges.

Disposal



You should now recycle your waste electrical goods and in doing so help the environment. This symbol means an electrical product should not be disposed of with normal household waste. Please ensure it is taken to a suitable facility for disposal when finished with.

Visit www.recycle-more.co.uk, click on "bank locator" and enter your postcode to find your nearest recycling site.

This product is intended for use within the UK. This equipment complies with the essential requirements for the Radio Equipment Directive 2014/53/EU.



Declaration of Conformance

Hereby, Argos Ltd, declares that this Band II LPD device is in compliance + with the essential requirements and other relevant provisions of Directive 2014/53/EU. The complete declaration of conformity can be obtained by contacting <http://www.argos-support.co.uk/>

BUSH

Call us now and activate your 12 month guarantee

Thank you for choosing Bush. Your new product is guaranteed against faults and breakdowns for 12 months. Don't forget to register it with us today so we can provide you with our best possible after-sales service and useful updates.

www.bushregistration.co.uk

FREEPHONE*

0800 597 8548

Lines are open 8am - 8pm, 365 days a year. *Calls may be recorded and monitored.

Your Bush Guarantee

This product is guaranteed for twelve months from the date of original purchase. Any defect that arises due to faulty materials or workmanship will be repaired free of charge (or if applicable the product will be replaced or the purchase price refunded) where possible during this period by the dealer from who you purchased the unit.

The guarantee is subject to the following provisions:

- The guarantee does not cover accidental damage, misuse, cabinet parts, knobs or consumable items.
- The product must be correctly installed and operated in accordance with the instructions contained in the manual.
- It must be used solely for domestic purposes. The guarantee will be rendered invalid if the product is re-sold or has been damaged by inexpert repair.
- Specifications are subject to change without notice.
- Bush disclaim any liability for loss or damage arising from the breakdown of the product.
- This guarantee is in addition to and does not diminish your statutory or legal rights.

Important Data Protection Information

If you provide us with information about another person, you confirm that they have appointed you to act for them, to consent to the processing of their personal data including sensitive personal data and that you have informed them of our identity and the purposes (as set out in the Important Data Privacy notice displayed overleaf) for which their personal data will be processed.

You are entitled to ask for a copy of the information we hold about you (for which we may charge a small fee) and to have any inaccuracies in your information corrected.

For quality control and training purposes, we may monitor or record your communications with us.

If your personal details change, if you change your mind about any of your marketing preferences or if you have any queries about how we use your information, please let us know by contacting our Data Protection Officer, Domestic & General, Leicester House 17 Leicester Street, Bedworth, Warwickshire, CV12 8JP.

Guarantor: Argos Limited - 489 - 499 Avebury Blvd. - Milton Keynes - MK9 2NW