

# **Acer LCD Monitor**

## **User Guide**

Copyright © 2016. Acer Incorporated.  
All Rights Reserved.

Acer LCD Monitor User Guide  
Original Issue: 4/2016

Changes may be made periodically to the information in this publication without obligation to notify any person of such revisions or changes. Such changes will be incorporated in new editions of this manual or supplementary documents and publications. This company makes no representations or warranties, either expressed or implied, with respect to the contents hereof and specifically disclaims the implied warranties of merchantability or fitness for a particular purpose.

Record the model number, serial number, purchase date and place of purchase information in the space provided below. The serial number and model number are recorded on the label affixed to your computer. All correspondence concerning your unit should include the serial number, model number and purchase information.

No part of this publication may be reproduced, stored in a retrieval system, or transmitted, in any form or by any means, electronically, mechanically, by photocopy, recording or otherwise, without the prior written permission of Acer Incorporated.

Acer LCD Monitor User Guide

Model number: \_\_\_\_\_

Serial number: \_\_\_\_\_

Date of purchase: \_\_\_\_\_

Place of purchase: \_\_\_\_\_

Acer and the Acer logo are registered trademarks of Acer Incorporated. Other companies' product names or trademarks are used herein for identification purposes only and belong to their respective companies.

# Information for your safety and comfort

## Safety instructions

Read these instructions carefully. Keep this document for future reference. Follow all warnings and instructions marked on the product.

## Special notes on LCD monitors

The following are normal with the LCD monitor and do not indicate a problem.

- Due to the nature of the fluorescent light, the screen may flicker during initial use. Turn off the power switch and then turn it on again to make sure the flicker disappears.
- You may find slightly uneven brightness on the screen depending on the desktop pattern you use.
- The LCD screen has 99.99% or more effective pixels. It may include blemishes of 0.01% or less such as a missing pixel or pixel lit all the time.
- Due to the nature of the LCD screen, an afterimage of the previous screen may remain after switching the image, when the same image is displayed for hours. In this case, the screen is recovered slowly by changing the image or turning off the power switch for a few hours.

## Cleaning your monitor

Please carefully follow these guidelines when cleaning the monitor:

- Always unplug the monitor before cleaning.
- Use a soft cloth to wipe the screen and cabinet front and sides.

## Accessibility

Be sure that the power outlet you plug the power cord into is easily accessible and located as close to the equipment operator as possible. When you need to disconnect power from the equipment, be sure to unplug the power cord from the electrical outlet.

## Safe listening

To protect your hearing, follow these instructions.

- Gradually increase the volume until you can hear it clearly and comfortably and without distortion.
- After setting the volume level, do not increase it after your ears have adjusted.
- Limit the amount of time listening to music at high volume.
- Avoid turning up the volume to block out noisy surroundings.
- Turn the volume down if you can't hear people speaking near you.

## Warnings

- Do not use this product near water.
- Do not place this product on an unstable cart, stand or table. If the product falls, it could be seriously damaged.
- Slots and openings are provided for ventilation to ensure reliable operation of the product and to protect it from overheating. These openings must not be blocked or covered. The openings should never be blocked by placing the product on a bed, sofa, rug or other similar surface. This product should never be placed near or over a radiator or heat register, or in a built-in installation unless proper ventilation is provided.
- Never push objects of any kind into this product through cabinet slots as they may touch dangerous voltage points or short-out parts that could result in a fire or electric shock. Never spill liquid of any kind onto or into the product.
- To avoid damage of internal components and to prevent battery leakage, do not place the product on a vibrating surface.
- Never use it under sporting, exercising, or any vibrating environment which will probably cause unexpected short current or damage internal devices.
- The adapter is only used for this monitor, do not be used for other purposes.
- Your device uses one of the following power supplies:  
Manufacture: DELTA:ADP-180MB K(19.5Vdc/9.23A)

## Using electrical power

- This product should be operated from the type of power indicated on the marking label. If you are not sure of the type of power available, consult your dealer or local power company.
- Do not allow anything to rest on the power cord. Do not locate this product where people will walk on the cord.

- If an extension cord is used with this product, make sure that the total ampere rating of the equipment plugged into the extension cord does not exceed the extension cord ampere rating. Also, make sure that the total rating of all products plugged into the wall outlet does not exceed the fuse rating.
- Do not overload a power outlet, strip or receptacle by plugging in too many devices. The overall system load must not exceed 80% of the branch circuit rating. If power strips are used, the load should not exceed 80% of the power strip's input rating.
- This product's power cord is equipped with a three-wire grounded plug. The plug only fits in a grounded power outlet. Make sure the power outlet is properly grounded before inserting the power cord plug. Do not insert the plug into a non-grounded power outlet. Contact your electrician for details.



.....

**Warning! The grounding pin is a safety feature. Using a power outlet that is not properly grounded may result in electric shock and/or injury.**



.....

**Note:** The grounding pin also provides good protection from unexpected noise produced by other nearby electrical devices that may interfere with the performance of this product.

- Use the product only with the supplied power supply cord set. If you need to replace the power cord set, make sure that the new power cord meets the following requirements: detachable type, UL listed/CSA certified, type SPT-2, rated 7 A 125 V minimum, VDE approved or its equivalent, 4.6 meters (15 feet) maximum length.

## Product servicing

Do not attempt to service this product yourself, as opening or removing covers may expose you to dangerous voltage points or other risks. Refer all servicing to qualified service personnel.

Unplug this product from the wall outlet and refer servicing to qualified service personnel when:

- the power cord or plug is damaged, cut or frayed
- liquid was spilled into the product
- the product was exposed to rain or water
- the product has been dropped or the case has been damaged
- the product exhibits a distinct change in performance, indicating a need for service
- the product does not operate normally after following the operating instructions



**Note:** Adjust only those controls that are covered by the operating instructions, since improper adjustment of other controls may result in damage and will often require extensive work by a qualified technician to restore the product to normal condition.

## Potentially explosive environments

Switch off your device in any area with a potentially explosive atmosphere and obey all signs and instructions. Potentially explosive atmospheres include areas where you would normally be advised to turn off your vehicle engine. Sparks in such areas could cause an explosion or fire resulting in bodily injury or even death. Switch off the device near depots, storage and distribution areas; chemical plants; or where blasting operations are in progress. Areas with a potentially explosive atmosphere are often, but not always, marked. They include below deck on boats, chemical transfer or storage facilities, vehicles using liquefied petroleum gas (such as propane or butane), and areas where the air contains chemicals or particles such as grain, dust or metal powders.

## Additional safety information

Your device and its enhancements may contain small parts. Keep them out of the reach of small children.

## IT Equipment Recycling Information

Acer is strongly committed to environmental protection and views recycling, in the form of salvaging and disposal of used equipment, as one of the company's top priorities in minimizing the burden placed on the environment.

We at Acer are very conscious of the environmental effects of our business and strive to identify and provide the best working procedures to reduce the environmental impact of our products.

For more information and help when recycling, please go to this website:

<http://www.acer-group.com/public/Sustainability/sustainability01.htm>

Visit [www.acer-group.com](http://www.acer-group.com) for further information on the features and benefits of our other products.

## Disposal instructions



Do not throw this electronic device into the trash when discarding. To minimize pollution and ensure utmost protection of the global environment, please recycle. For more information on the Waste from Electrical and Electronics Equipment (WEEE) regulations, visit <http://www.acer-group.com/public/Sustainability/sustainability01.htm>

## LCD pixel statement

The LCD unit is produced with high-precision manufacturing techniques. Nevertheless, some pixels may occasionally misfire or appear as black or red dots. This has no effect on the recorded image and does not constitute a malfunction.

This product has been shipped enabled for power management:

- Activate display's Sleep mode within 15 minutes of user inactivity.
- Activate computer's Sleep mode within 30 minutes of user inactivity.
- Wake the computer from Sleep mode by pushing the power button.

## Tips and information for comfortable use

Computer users may complain of eyestrain and headaches after prolonged use. Users are also at risk of physical injury after long hours of working in front of a computer. Long work periods, bad posture, poor work habits, stress, inadequate working conditions, personal health and other factors greatly increase the risk of physical injury.

Incorrect computer usage may lead to carpal tunnel syndrome, tendonitis, tenosynovitis or other musculoskeletal disorders. The following symptoms may appear in the hands, wrists, arms, shoulders, neck or back:

- numbness, or a burning or tingling sensation
- aching, soreness or tenderness
- pain, swelling or throbbing
- stiffness or tightness
- coldness or weakness

If you have these symptoms, or any other recurring or persistent discomfort and/or pain related to computer use, consult a physician immediately and inform your company's health and safety department.

The following section provides tips for more comfortable computer use.

## Finding your comfort zone

Find your comfort zone by adjusting the viewing angle of the monitor, using a footrest, or raising your sitting height to achieve maximum comfort. Observe the following tips:

- refrain from staying too long in one fixed posture
- avoid slouching forward and/or leaning backward
- stand up and walk around regularly to remove the strain on your leg muscles

## Taking care of your vision

Long viewing hours, wearing incorrect glasses or contact lenses, glare, excessive room lighting, poorly focused screens, very small typefaces and low-contrast displays could stress your eyes. The following sections provide suggestions on how to reduce eyestrain.

### Eyes

- Rest your eyes frequently.
- Give your eyes regular breaks by looking away from the monitor and focusing on a distant point.
- Blink frequently to keep your eyes from drying out.

### Display

- Keep your display clean.
- Keep your head at a higher level than the top edge of the display so your eyes point downward when looking at the middle of the display.
- Adjust the display brightness and/or contrast to a comfortable level for enhanced text readability and graphics clarity.
- Eliminate glare and reflections by:
  - placing your display in such a way that the side faces the window or any light source
  - minimizing room light by using drapes, shades or blinds
  - using a task light
  - changing the display's viewing angle
  - using a glare-reduction filter
  - using a display visor, such as a piece of cardboard extended from the display's top front edge
- Avoid adjusting your display to an awkward viewing angle.
- Avoid looking at bright light sources, such as open windows, for extended periods of time.

## Developing good work habits

Develop the following work habits to make your computer use more relaxing and productive:

- Take short breaks regularly and often.
- Perform some stretching exercises.
- Breathe fresh air as often as possible.
- Exercise regularly and maintain a healthy body.





Acer Incorporated  
8F, 88, Sec. 1, Xintai 5th Rd., Xizhi  
New Taipei City 221, Taiwan

## Conformiteitverklaring

Wij,

**Acer Incorporated**  
8F, 88, Sec. 1, Xintai 5th Rd., Xizhi, New Taipei City 221, Taiwan

En,

**Acer Italy s.r.l.**  
Via Lepetit, 40, 20020 Lainate (MI) Italië  
Tel: +39-02-939-921, Fax: +39-02 9399-2913  
www.acer.it

**Product:** LCD-monitor  
**Handelsnaam:** Acer  
**Modelnummer:** XR342CK  
**SKU-nummer:** XR342CK xxxxxx;  
("x" = 0-9, a-z, A-Z, of leeg)

Wij, Acer Incorporated, verklaren hierbij onder exclusieve verantwoordelijkheid dat het hierboven beschreven product voldoet aan de relevante wetten op harmonisering in de Unie zoals in de onderstaande Richtlijn en dat de geharmoniseerde normen en/of andere relevante standaarden werden toegepast:

**EMC-richtlijn: 2014/30/EU**

<input checked="" type="checkbox"/> EN 55022:2010+AC:2011 Klasse B	<input checked="" type="checkbox"/> EN 55024:2010
<input checked="" type="checkbox"/> EN 61000-3-2:2006+A2:2009 Klasse D	<input checked="" type="checkbox"/> EN 61000-3-3:2013

**LVD-richtlijn: 2014/35/EU**

<input checked="" type="checkbox"/> EN 60950-1:2006/A11:2009/A1:2010/A12:2011/A2:2013
---

**RoHS-richtlijn: 2011/65/EU**

<input checked="" type="checkbox"/> EN 50581:2012
---

**ErP-richtlijn: 2009/125/EG**

<input checked="" type="checkbox"/> Verordening (EG) nr. 1275/2008; EN 50564:2011
---

Jaar om de CE-markering te beginnen aanbrengen: 2016.

**RU Jan / Sr. Manager**  
**Acer Incorporated (Taipei, Taiwan)**

**Sep.05,2016**

**Date**



**Acer Incorporated**  
8F, 88, Sec. 1, Xintai 5th Rd., Xizhi  
New Taipei City 221, Taiwan

## Conformiteitverklaring

Wij,

**Acer Incorporated**

8F, 88, Sec. 1, Xintai 5th Rd., Xizhi, New Taipei City 221, Taiwan

En,

**Acer Italy s.r.l.**

Via Lepetit, 40, 20020 Lainate (MI) Italië

Tel: +39-02-939-921, Fax: +39-02-9399-2913

www.acer.it

<b>Product:</b>	<b>LCD-monitor</b>
<b>Handelsnaam:</b>	<b>Acer</b>
<b>Modelnummer:</b>	<b>XR382CQK</b>
<b>SKU-nummer:</b>	<b>XR382CQK xxxxxx;</b>
	<b>("x" = 0-9, a-z, A-Z, of leeg)</b>

Wij, Acer Incorporated, verklaren hierbij onder exclusieve verantwoordelijkheid dat het hierboven beschreven product voldoet aan de relevante wetten op harmonisering in de Unie zoals in de onderstaande Richtlijn en dat de geharmoniseerde normen en/of andere relevante standaarden werden toegepast:

**EMC-richtlijn: 2014/30/EU**

EN 55022:2010+AC:2011 Klasse B

EN 55024:2010

EN 61000-3-2:2006+A2:2009 Klasse D

EN 61000-3-3:2013

**LVD-richtlijn: 2014/35/EU**

EN 60950-1:2006/A11:2009/A1:2010/A12:2011/A2:2013

**RoHS-richtlijn: 2011/65/EU**

EN 50581:2012

**ErP-richtlijn: 2009/125/EG**

Verordening (EG) nr. 1275/2008; EN 50564:2011

Jaar om de CE-markering te beginnen aanbrengen: 2016.

**RU Jan / Sr. Manager**  
**Acer Incorporated (Taipei, Taiwan)**

**Nov.30,2016**

**Date**



**Acer America Corporation**  
333 West San Carlos St., San Jose  
Suite 1500  
CA 95110, U. S. A.  
Tel : 254-298-4000  
Fax : 254-298-4147  
www.acer.com

English



## Federal Communications Commission Declaration of Conformity

This device complies with Part 15 of the FCC Rules. Operation is subject to the following two conditions: (1) this device may not cause harmful interference, and (2) this device must accept any interference received, including interference that may cause undesired operation.

The following local Manufacturer /Importer is responsible for this declaration:

<b>Product:</b>	LCD Monitor
<b>Model Number:</b>	XR342CK/XR382CQK
<b>SKU Number:</b>	XR342CK/XR382CQK xxxxxx ("x" = 0~9, a ~ z, or A ~ Z)
<b>Name of Responsible Party:</b>	Acer America Corporation
<b>Address of Responsible Party:</b>	333 West San Carlos St. Suite 1500 San Jose, CA 95110 U. S. A.
<b>Contact Person:</b>	Acer Representative
<b>Phone No.:</b>	254-298-4000
<b>Fax No.:</b>	254-298-4147

<b>Information for your safety and comfort</b>	<b>iii</b>
Safety instructions	iii
Special notes on LCD monitors	iii
Cleaning your monitors	iii
Accessibility	iv
Safe listening	iv
Warnings	iv
Using electrical power	iv
Product servicing	v
Potentially explosive environments	vi
Additional safety information	vi
IT Equipment Recycling Information	vi
Disposal instructions	vi
LCD pixel statement	vii
Tips and information for comfortable use	vii
Finding your comfort zone	vii
Taking care of your vision	viii
Developing good work habits	viii
Declaration of Conformity	ix
Federal Communications Commission	
Declaration of Conformity	x
<b>Unpacking</b>	<b>1</b>
Attaching the base (for selected models)	2
Screen position adjustment	3
Connecting the adapter and AC Power cord	3
Power saving	
Display Data Channel (DDC)	
Connector pin assignment	4
19-pin color display signal cable	4
20-pin color display signal cable	4
<b>Standard timing table</b>	<b>7</b>
<b>Installation</b>	<b>9</b>
<b>Users controls</b>	<b>10</b>
Panel controls	10
Using the Shortcut Menu	11
The Function page	12
<b>Troubleshooting</b>	<b>17</b>
HDMI/DP/DP ALT Mode (Optional)	17

# Unpacking

Please check that the following items are present when you unpack the box, and save the packing materials in case you need to ship or transport the monitor in the future.

LCD monitor

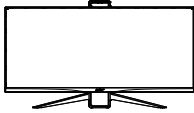

Quick start guide



AC Adapter

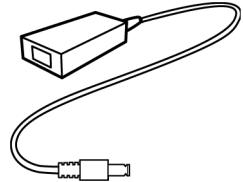

DP Cable  
(Optional)

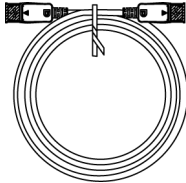

HDMI cable  
(Optional)

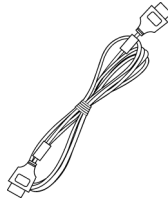

AC Power cord

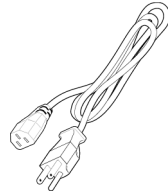

USB 3.1 Type C-C cable  
(Optional)

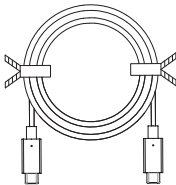

MHL cable  
(Optional)

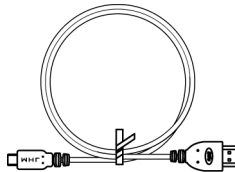

Wall mount BKT

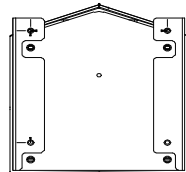

Headset hook

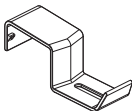

# SCREEN POSITION ADJUSTMENT

In order to optimize the best viewing position, you can adjust the height/tilt of the monitor.

- **Height Adjustment**

After pressing the top of the monitor then you can adjust the height of the monitor.

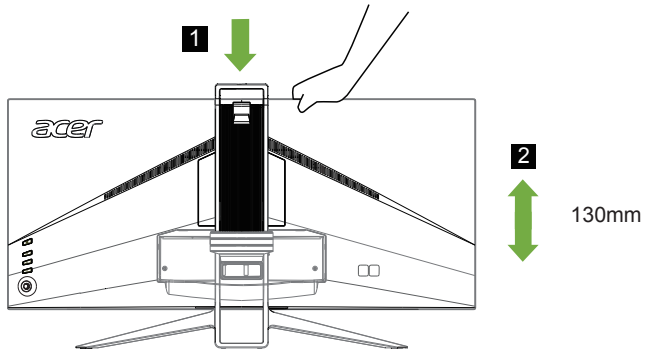

- **Tilt**

Please see the illustration below for an example of the tilt range.

Only at the highest point can 35 degrees of recline be offered for the angle of elevation.

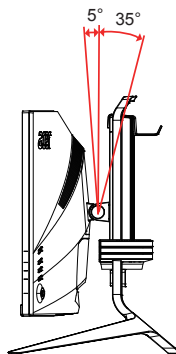

## Connecting the adapter and AC Power cord

- Check first to make sure that the power cord you use is the correct type required for your area.
- The monitor has a universal power supply that allows operation in either 100/120 V AC or 220/240 V AC voltage area. No user-adjustment is required.
- Plug one end of the AC power cord to the Adapter, and plug the other end into an AC outlet.
- For units using 120 V AC:  
Use a UL-listed cord set, type SVT wire and plug rated 10 A/125 V.
- For units using 220/240 V AC:  
Use a cord set consisting of H05VV-F cord and plug rated 10 A/250 V. The cord set should have the appropriate safety approvals for the country in which the equipment will be installed.

## Power saving

The monitor will be driven into "Power Saving" mode by the control signal from the display controller, as indicated by the amber-color power LED.

State	LED Light
ON	Blue
Power Saving Mode	Amber

The power saving states will be kept until a control signal has been detected or the keyboard or mouse is activated. The recovery time from Active OFF state back to ON state is around 3 seconds.

## Display Data Channel (DDC)

To make installation easier, so long as your system supports the DDC protocol, the monitor is able to plug-and-play. The DDC is a communication protocol through which the monitor automatically informs the host system about its capabilities; for example, supported resolutions and corresponding timing. The monitor supports the DDC2B standard.

## 20-pin color display signal cable

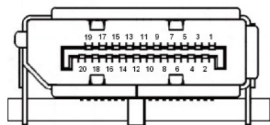

PIN No.	Description	PIN No.	Description
1	ML_Lane 0+	2	GND
3	ML_Lane 0-	4	ML_Lane 1+
5	GND	6	ML_Lane 1-
7	ML_Lane 2+	8	GND
9	ML_Lane 2-	10	ML_Lane 3+
11	GND	12	ML_Lane 3-
13	KONFIG1	14	CONFIG2
15	AUX CH+	16	GND
17	AUX CH-	18	Hot Plug
19	Return	20	DP_PWR

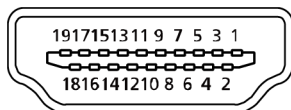

\*19-pin Color Display Signal Cable

PIN No.	Description
7.	MHL+
9.	MHL-
18.	VBUS
19.	CBUS
5, 11, 17	GND

\* Only for MHL models



## 19-pin color display signal cable

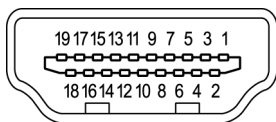

PIN No.	Description	PIN No.	Description
1	TMDS Data2+	2	TMDS Data2 Shield
3	TMDS Data2-	4	TMDS Data1+
5	TMDS Data1 Shield	6	TMDS Data1-
7	TMDS Data0+	8	TMDS Data0 Shield
9	TMDS Data0-	10	TMDS Clock+
11	TMDS Clock Shield	12	TMDS Clock-
13	CEC	14	Reserved (N.C. on device)
15	SCL	16	SDA
17	DDC/CEC Ground	18	+5V Power
19	Hot Plug Detect		

## 24-pin USB 3.1 Type C cable

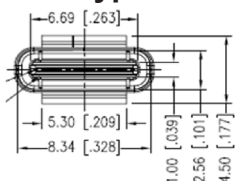

PIN No.	Signal Assignment	PIN No.	Signal Assignment
A1	GND	B12	GND
A2	SSTXp1	B11	SSTXp1
A3	SSTXn1	B10	SSTXn1
A4	VBUS	B9	VBUS
A5	CC1	B8	CC1
A6	Dp1	B7	Dp1
A7	Dn1	B6	Dn1
A8	SBU1	B5	SBU1
A9	VBUS	B4	VBUS
A10	SSTXn2	B3	SSTXn2
A11	SSTXp2	B2	SSTXp2
A12	GND	B1	GND

# Daisy chain

Extended: The number of DP output connections.

## XR342CK

Monitor 2 Monitor 1	2560x1440@60 RB (10bit)	2560x1440@60 RB (8bit)	1920x1080@60 (10bit)	1920x1080@60 (8bit)
3440x1440@75 RB (10bit)	No	No	Yes	Yes
3440x1440@75 RB (8bit)	No	Yes	Yes	Yes

## XR382CQK

Monitor 2 Monitor 1	2560x1440@60 RB (10bit)	2560x1440@60 RB (8bit)	1920x1080@60 (10bit)	1920x1080@60 (8bit)
3840x1600@75 RB (10bit)	No	No	No	No
3840x1600@75 RB (8bit)	No	Yes	Yes	Yes

## Standard timing table (XR342CK)

MODE	Resolution		
1	VGA	640x480	60Hz
2	VGA	640x480	72Hz
3	VGA	640x480	75Hz
4	MAC	640x480	67Hz
5	VESA	720x400	70Hz
6	SVGA	800x600	56Hz
7	SVGA	800x600	60Hz
8	SVGA	800x600	72Hz
9	SVGA	800x600	75Hz
10	MAC	832x624	75Hz
11	XGA	1024x768	60Hz
12	XGA	1024x768	70Hz
13	XGA	1024x768	75Hz
14	MAC	1152x870	75Hz
15	VESA	1152x864	75Hz
16	VESA	1280x960	60Hz
17	SXGA	1280x1024	60Hz
18	SXGA	1280x1024	75Hz
19	VESA	1280x720	60Hz
20	WXGA	1280x800	60Hz
21	WXGA+	1440x900	60Hz
22	WSXGA+	1680x1050	60Hz
23	FHD	1920x1080	60Hz
24	Wide HD	2560x1080	60Hz
25	QHD	3440x1440 <sup>①</sup>	30Hz
26	QHD	3440x1440	60Hz
27	QHD	3440x1440	75Hz

<sup>①</sup> HDMI 2.0 only

## Standard timing table(XR382CQK)

VESA MODE			
MODE	Resolution		
1	VGA	640x480	60Hz
2	VGA	640x480	72Hz
3	VGA	640x480	75Hz
4	MAC	640x480	67Hz
5	VESA	720x400	70Hz
6	SVGA	800x600	56Hz
7	SVGA	800x600	60Hz
8	SVGA	800x600	72Hz
9	SVGA	800x600	75Hz
10	MAC	832x624	75Hz
11	XGA	1024x768	60Hz
12	XGA	1024x768	70Hz
13	XGA	1024x768	75Hz
14	MAC	1152x870	75Hz
15	VESA	1152x864	75Hz
16	VESA	1280x960	60Hz
17	SXGA	1280x1024	60Hz
18	SXGA	1280x1024	75Hz
19	VESA	1280x720	60Hz
20	WXGA	1280x800	60Hz
21	WXGA+	1440x900	60Hz
22	WSXGA+	1680x1050	60Hz
23	FHD	1920x1080	60Hz
24	Wide HD	2560x1080	60Hz
25	WQHD+	3840x1600 <sup>①</sup>	30Hz
26	WQHD+	3840x1600	60Hz
27	WQHD+	3840x1600	75Hz

<sup>①</sup> HDMI 2.0 only

# Installation

1. Turn off your computer and unplug your computer's power cord.
2. Connect the signal cable to the HDMI (optional) and /or DP (optional) and /or MHL (optional) input socket of the monitor, and the HDMI (optional) and /or DP (optional) and /or MHL (optional) output socket of the graphics card on the computer. Then tighten the thumbscrews on the signal cable connector.
3. USB 3.1 Type C-C Cable(Optional, USB Type C-C input models only)  
Connect one end of the USB 3.1 Type C-C cable (optional) to your computer and connect the other end to your electric devices.
4. Insert the monitor power cable into the power port at the back of the monitor.
5. Connect the power adapter and power cord to the monitor, then to a properly grounded AC outlet.

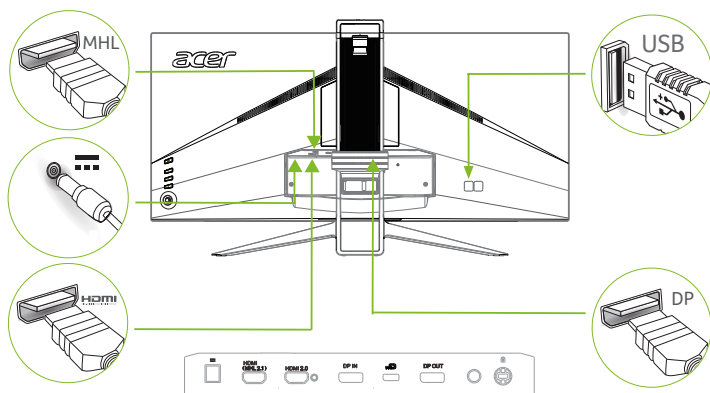

## User Controls

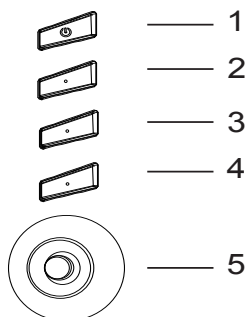

## External controls

1	Power button	Turns the monitor on/off. Blue indicates power on. Amber indicates standby/ power saving mode.
2	Function key 	<ol style="list-style-type: none"> <li>Press to view Main page. Press again to enter hotkey1 function.</li> <li>When the Function Menu is active, press this key to view the basic information for your monitor and current input or reset the custom color settings to the factory defaults.</li> </ol>
3	Function key 	<ol style="list-style-type: none"> <li>Press to view Main page. Press again to enter hotkey2 function.</li> <li>When the Function Menu is active, press this button to select select scenario mode or game mode .</li> </ol>
4	Function key 	<ol style="list-style-type: none"> <li>Press to view Main page. Press again to enter Input select function.</li> <li>When the Function Menu is active, this button will quit the OSD.</li> </ol>
5	Function key 	<ol style="list-style-type: none"> <li>Press to view Main page. Press again to enter next function in the Function Menu.</li> <li>The single toggle button on the backside of the Display bezel operates like a joystick. To move the cursor, simply toggle the button in four directions. Press the button to select desired option. Red indicates operable. Grey indicates inoperable.</li> </ol>

### AdaptiveSync(XR342CK):

It can allow a AdaptiveSync supported graphics source to dynamically adjust display refresh rate based on typical content frame rates for power efficient, virtually stutter free and low-latency display update.

### Free-Sync(XR382CQK):

It can allow a Free-Sync supported graphics source to dynamically adjust display refresh rate based on typical content frame rates for power efficient, virtually stutter free and low-latency display update.

### DTS Sound:

 For DTS patents, see <http://patents.dts.com>. Manufactured under license from DTS Licensing Limited. DTS, the Symbol, & DTS and the Symbol together are registered trademarks, and DTS Sound is a trademark of DTS, Inc. © DTS, Inc. All Rights Reserved.

## Using the Shortcut Menu



**Note:** The following content is for general reference only. Actual product specifications may vary.

The OSD (onscreen display) can be used to adjust the settings of your LCD monitor. Press the MENU key to open the OSD. You can use the OSD to adjust the picture quality, OSD position and general settings. For advanced settings, please refer to following page:

### Main page

	<ol style="list-style-type: none"> <li>Hot Key1 (Modes, Brightness, Volume, Gamma, Contrast, Blue Light, Over Drive, PIP/PBP)</li> <li>Hot Key2 (Modes, Brightness, Volume, Gamma, Contrast, Blue Light, Over Drive, PIP/PBP)</li> <li>Input selection</li> <li>Menu OSD</li> </ol>
--	---

### Hot key1 (default: Game mode)

To choose game mode (G1, G2, G3) which user-defined profile to use or scenario mode (User, Standard, ECO, Graphics, Movie)

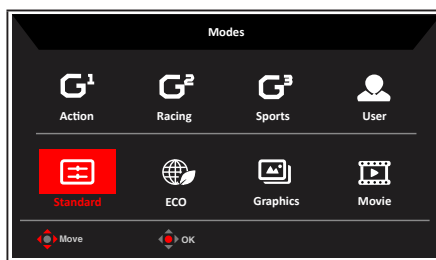

### Hot key2 (default: Brightness)

Open the Brightness control and select your preferred brightness setting. When you are done, press the joystick to quit current page and store.

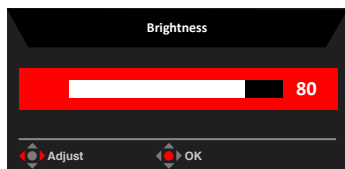

## Selecting the input

Open the Input control and select HDMI2.0, HDMI (MHL2.1), DP ALT, DP In or Auto Source. When you are done, press the joystick to exit current page and store.

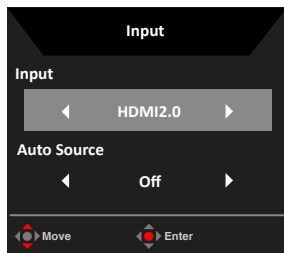

## The Function page

Open the Function page to adjust the functions, settings which you want using the arrows. When you are done, toggle the joystick to the left or right to go back one level or use

**X-** to exit current page and store.

## Picture

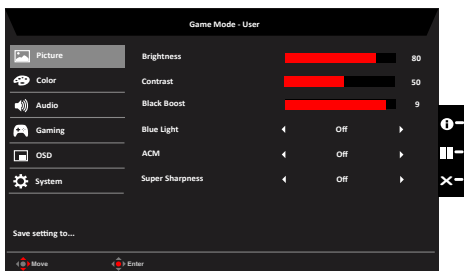

1. Press the MENU key to open the OSD.
2. Toggle the joystick to the up or down to select Picture from the OSD. Then toggle to the right to navigate to the element you wish to adjust and press the joystick to enter it.
3. Toggle to the left or right to adjust the sliding scales.
4. The Picture menu can be used to adjust the Brightness, Contrast, Black Boost, Blue Light, ACM and Super Sharpness.
5. Brightness: Adjust the brightness from 0 to 100.
 

---

**Note:** Adjusts the balance between light and dark shades.
6. Contrast: Adjust the contrast from 0 to 100.
 

---

**Note:** Sets the degree of difference between light and dark areas.
7. Black Boost: Adjust the black level from 0 to 10. Enhances shadows by increasing the brightness without changing lighter shades.
8. Blue Light: Filters out blue light to protect your eyes by adjusting how much blue light is



shown -- 80%, 70%, 60%, or 50%.



**Note:** Higher values allow more blue light through. For the best protection select a lower value.

9. ACM: Turn ACM on or off. The default is off.
10. Super Sharpness: Turn the Super Sharpness On or Off. Super Sharpness technology can simulate high-resolution images by boosting the pixel density of the original source to make images sharper and clearer.

## Color

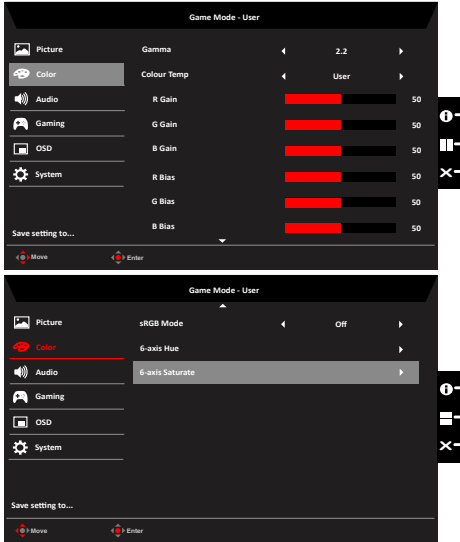

1. Press the MENU key to open the OSD.
2. Toggle the joystick to the up or down to select Color from the OSD. Then toggle to the right to navigate to the element you wish to adjust and press the joystick to enter it.
3. Toggle to the left or right to adjust the sliding scales.
4. Gamma mode allows you to adjust the luminance tone. The default value is 2.2 (standard value for Windows).
5. Color temperature: Default is warm. You can choose Cool, Normal, Warm, Bluelight or User.
6. sRGB: Default is off. You can turn sRGB on or off to better color match with peripheral devices, such as printers and digital cameras.
7. 6-axis Hue: Adjust the red, green, blue, yellow, magenta and cyan hue.
8. 6-axis Saturate: Adjust the red, green, blue, yellow, magenta and cyan saturation.

## Audio

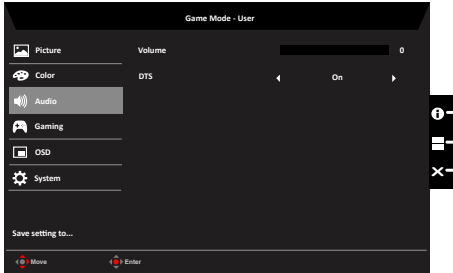

1. Press the MENU key to open the OSD.
2. Toggle the joystick to the up or down to select Audio from the OSD. Then toggle to the right to navigate to the element you wish to adjust and press the joystick to enter it.
3. Toggle to the left or right to adjust the sliding scales.
4. Volume: Adjust the volume
5. DTS: Turn DTS Sound On or Off. Your monitor is equipped with two 7W speakers on the rear. DTS Sound is stratified and creates a remarkable sonic flow.

## Gaming

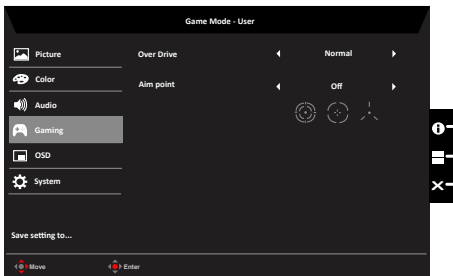

1. Press the MENU key to open the OSD.
2. Toggle the joystick to the up or down to select Gaming from the OSD. Then toggle to the right to navigate to the element you wish to adjust and press the joystick to enter it.
3. Toggle to the left or right to adjust the sliding scales.
4. OD: Select Off, Normal, or Extreme.
5. Aim point: Show an Aim point on the screen for shooting games.

## OSD

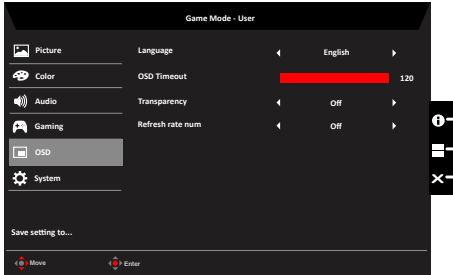

1. Press the MENU key to open the OSD.
2. Toggle the joystick to the up or down to select OSD from the OSD. Then toggle to the right to navigate to the element you wish to adjust and press the joystick to enter it.
3. Toggle to the left or right to adjust the sliding scales.
4. Language: Set the OSD menu language.
5. OSD timeout: Adjust the delay before turning off the OSD menu.
6. Transparency: Select the transparency when using gaming mode. The transparency can be 0% (OFF), 20%, 40%, 60%, or 80%.
7. Refresh rate num: Display the panel's current refresh rate on the screen.

## System

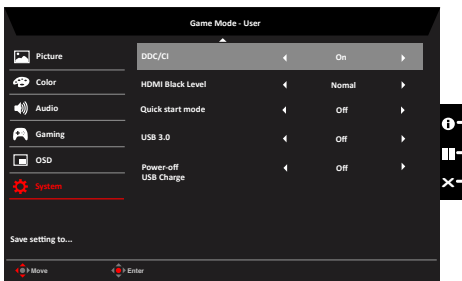
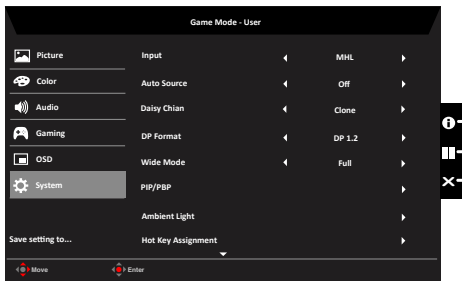

1. Press the MENU key to open the OSD.
2. Toggle the joystick to the up or down to select System from the OSD. Then toggle to the right to navigate to the element you wish to adjust and press the joystick to enter it.

3. Toggle to the left or right to adjust the sliding scales.
4. Input: Select the source from DP In, HDMI 2.0,HDMI(MHL),or DP ALT.
5. Auto Source:The default is "On", can support auto search for signal source in order.
6. Daisy Chain: Default is extend, can select daisy chain function extend or clone. Clone Mode is not supported with Adaptive-Sync.
7. DP Format :Default is DP1.2, can selection DP support DP1.1 or DP1.2 format.
8. Wide mode: You can select which screen aspect you are using. The options are Full, Aspect, and 1:1.
9. PIP/PBP settings
10. Ambient light: Adjust the lighting effects, color, and style. When choosing lighting effects by MNT Status, following colors will be shown:  
White: Normal mode.  
Red: Adaptive-Sync mode.
11. Hotkey Assignment: Select the function of shortcut key 1 (Modes, Brightness, Volume, Gamma, Contrast, Blue Light, Over Drive, PIP/PBP) and shortcut keys 2 (Modes, Brightness, Volume, Gamma, Contrast, Blue Light, Over Drive, PIP/PBP)
12. DDC/CI: Allows the monitor settings to be set through the software on the PC.



-----  
**Note:** DDC/CI, short for Display Data Channel/Command Interface, which allows monitor controls to be sent via software.

13. HDMI Black level setting.
14. Quick start mode: Select Off or On. Turn on to speed up boot speed.
15. DP ALT Mode: Default set USB 3.0 function OFF. Turn on USB 3.0 function, Using higher speed for data transport, display port only occupy on two lanes.  
On: Using 2 lanes for USB 3.0 high speed data and 2 lanes for DisplayPort signal.  
DP ALT maximum display resolution is QHD (3440x1440-30Hz).  
Off: Using full lanes to transport DisplayPort signal.  
DP ALT maximum display resolution is 4K (3440x1440-75Hz)
16. Power-off USB charge: Turn On or Off.

## Save Setting to...(User mode only)

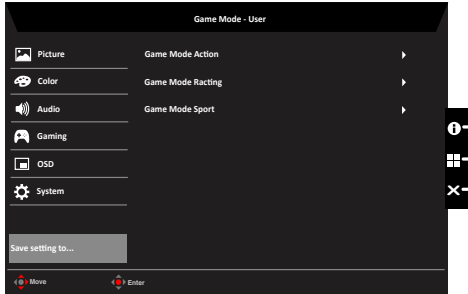

1. Press the MENU key to open the OSD.
2. Toggle the joystick to the up or down to select "Save Setting to..." from the OSD. Then toggle the right to navigate to the element you wish to adjust and press the joystick to enter it.
3. Save Setting to Game mode: There are three user-defined profiles available. When you have decided what settings suit you, save them and system will be able to recall the settings in the future when you turn on gaming mode .

## Troubleshooting

Before sending your LCD monitor for servicing, please check the troubleshooting list below to see if you can self-diagnose the problem.

### HDMI/DP/DP ALT Mode (Optional)

Problem	LED status	Remedy
No picture visible	Blue	Using the OSD menu, adjust brightness and contrast to maximum or reset to their default setting.
	Off	Check the power switch.
		Check if the AC power cord is properly connected to the monitor.
Amber	Check if the video signal cable is properly connected at the back of monitor.	
	Check if the computer system is switched on and in power saving/standby mode.	