

FR

Lire attentivement le livret consignes de sécurité et ce livret avant la première utilisation.

EN

Read safety instructions and booklet carefully before using for the first time.

DE

Lesen Sie vor der ersten Benutzung die Sicherheitshinweise und die Broschüre sorgfältig durch.

NL

Neem vóór het eerste gebruik dit boekje en het boekje met de veiligheidsvoorschriften aandachtig door.

IT

Leggere con attenzione il libretto sulle norme di sicurezza e questo libretto, al primo utilizzo.

ES

Lea detenidamente las instrucciones de seguridad y este folleto antes de utilizar el aparato por primera vez.

PT

Leia atentamente as instruções de segurança bem como este folheto antes da primeira utilização.

EL

Διαβάστε προσεκτικά το φυλλάδιο με τις οδηγίες ασφαλείας καθώς και αυτό το φυλλάδιο πριν χρησιμοποιήσετε τη συσκευή για πρώτη φορά.

DA

Læs hæftet med sikkerhedsanvisninger og dette hæfte omhyggeligt, inden apparatet tages i brug første gang.

SV

Läs häftet med säkerhetsinstruktioner och det här häftet noga innan du använder apparaten första gången.

FI

Lue turvallisuuohjekirjanen ja tämä kirjanen huolellisesti ennen ensimmäistä käyttökertaa.

NO

Les nøye heftet med sikkerhetsinstruksjoner og dette heftet før første gangs bruk.

TR

Kullanmadan önce güvenlik talimatları kitapçığını ve bu kitapçığı dikkatlice okuyun.

RU

Перед первым использованием прибора внимательно ознакомьтесь с правилами техники безопасности и данной инструкцией.

UK

Прочитайте інструкції з техніки безпеки і цю брошуру перед використанням уперше.

KK

Бірінші рет қолданарда қауіпсіздік нұсқаулығын мұқият оқып шығыңыз.

RO

Citiți cu atenție manualul cu instrucțiunile de siguranță și această broșură înainte de prima utilizare.

SL

Pred prvo uporabo natančno preberite navodila za varno uporabo in ta navodila.

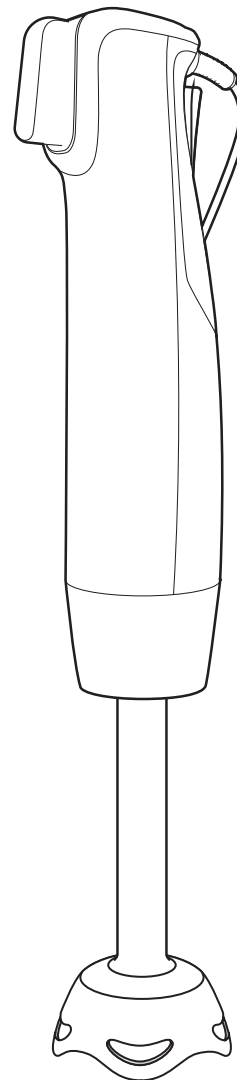
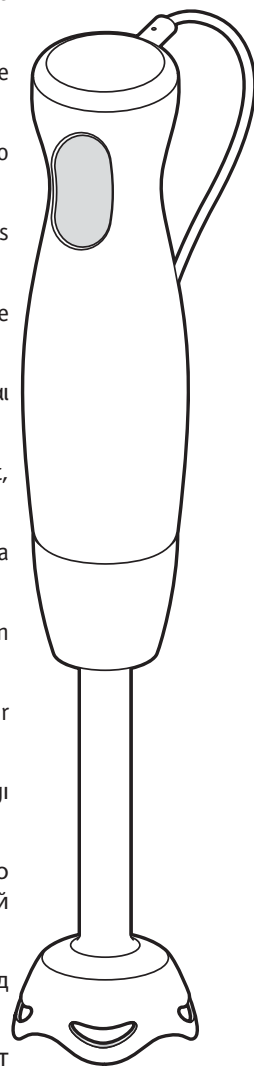

Pre prve upotrebe pažljivo pročitajte knjižicu s bezbednosnim uputstvima i ovu knjižicu.

Molimo da prije prve uporabe pažljivo pročitate sigurnosne upute i upute za uporabu.

Prije prve upotrebe pročitajte knjižicu sa sigurnosna uputstva i knjižicu o upotrebi.

Прочетете внимателно книжката и съветите за безопасност в нея преди първата употреба.

Lugege enne esimest kasutuskorda tähelepanelikult ohutusnõudeid ja seda brošüüri.

Pirms pirmās lietošanas uzmanīgi izlasiet drošības norādījumus un šo informāciju.

Prieš naudodami prietaisą pirmą kartą įdėmiai perskaitykite saugos instrukciją ir šią instrukciją.

Przed pierwszym korzystaniem z urządzenia przeczytaj uważnie książkę z zasadami bezpieczeństwa oraz niniejszą instrukcję.

Před prvním použitím si pozorně přečtěte brožuru s bezpečnostními pokyny a tuto brožuru.

Pred prvým použitím si pozorne prečítajte brožúru „Bezpečnostné odporúčania a použitie“.

Az első használat előtt figyelmesen olvassa el a biztonsági előírásokról szóló brosúrát és a jelen brosúrát.

อ่านคำแนะนำเพื่อความปลอดภัยและคู่มือการใช้งานอย่างละเอียดก่อนการใช้งานเป็นครั้งแรก

처음 사용 전 안전지침과 현 책자를 잘 읽어 두시기 바랍니다.

y ọc số tay hướng dẫn an toàn v cu n số tay này trước khi sử dụng.

使用前・請仔細閱讀安全建議手冊和說明書。

Sila baca buku arahan keselamatan dan buku ini sebelum penggunaan untuk kali pertama.

اقرأ كتاب تعليمات الأمان بعناية قبل أول استخدام.

قبل از استفاده، دفترچه راهنمای ایمنی و این دفترچه را مطالعه کنید.

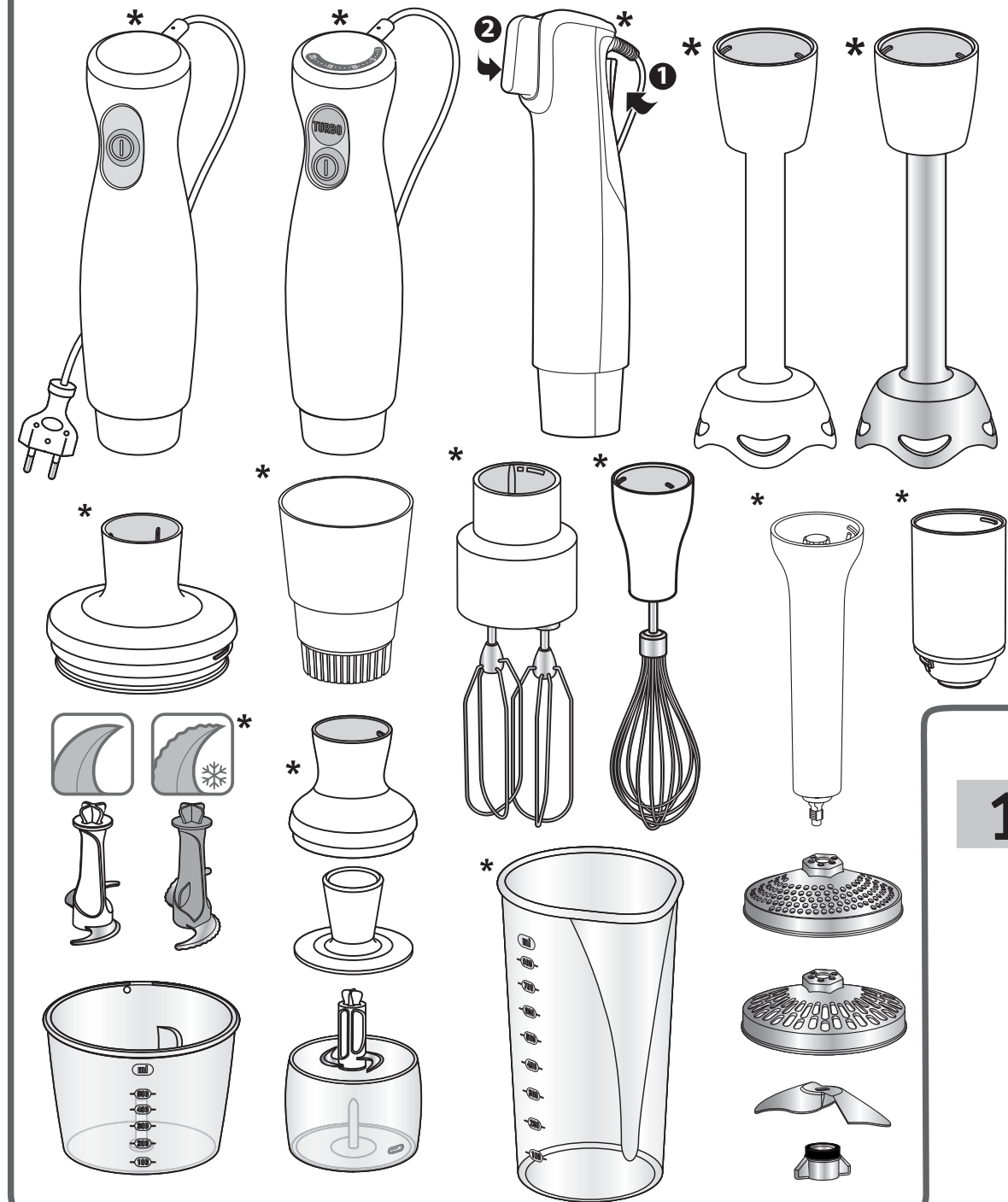

\*

*Selon modèle/Depending on model*  
*Je nach Modell/Afhankelijk van het model*  
*Secondo il modello/En función del modelo*  
*Consoante o modelo/ανάλογα με το μοντέλο*  
*Modelafhængig/Beroende på modell*  
*Mallista riippuen/Avhengig av modell*  
*Modele göre/V závislosti od modelu*  
*залежно від моделі/үлгіге байланысты*  
*în funcție de model/Glede na model*  
*U zavisnosti od modela/Ovisno o modelu / Ovisno o modelu*  
*B závislosti od modela/Soltuvalt mudelist*  
*Atbilstoši modelim/Priklausomai nuo modelio*  
*W zależności od modelu/Podle modelu*  
*Podľa modelu/Modelitól függően*  
*แตกต่างกันไปในแต่ละรุ่น / 모델에 따라 다름*  
*Tùy theo mẫu / 視乎型號而定*  
*Bergantung pada model*  
*برحسب مدل / حسب الموقزِيل*

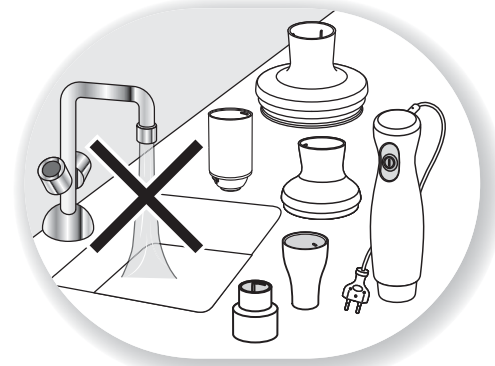
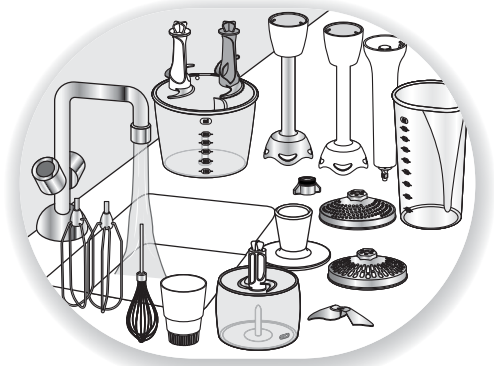
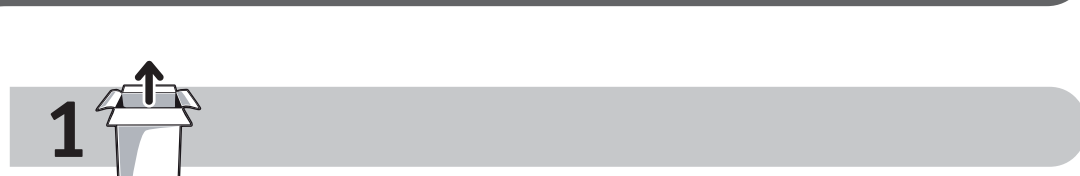

2

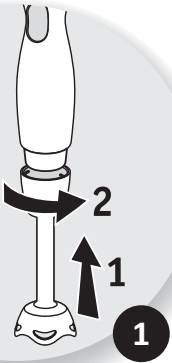
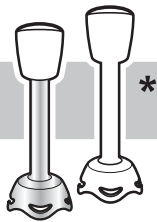

1

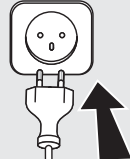

2

2

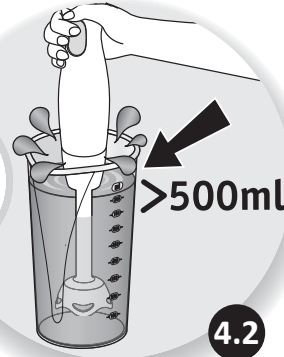
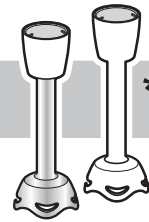

4.2

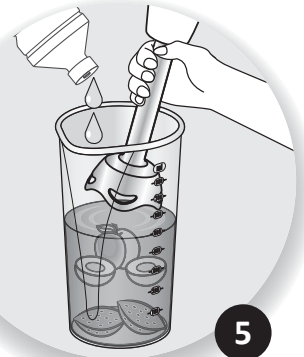

5



3.1

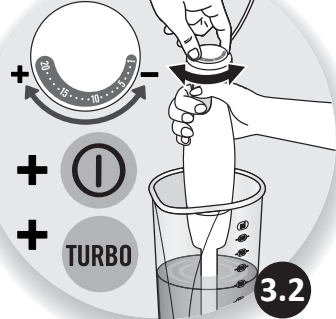

3.2



6



7



3.3\*

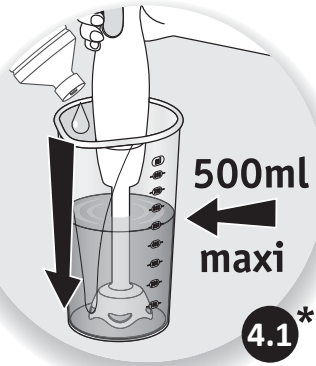

4.1\*

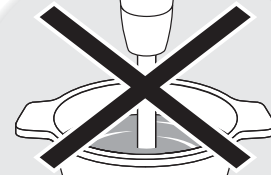

8

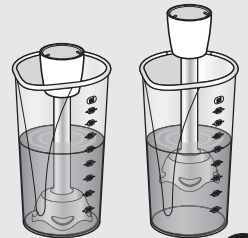

9

2

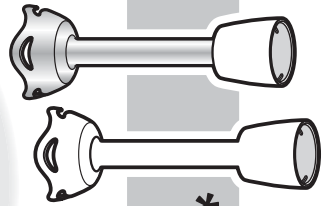

\*

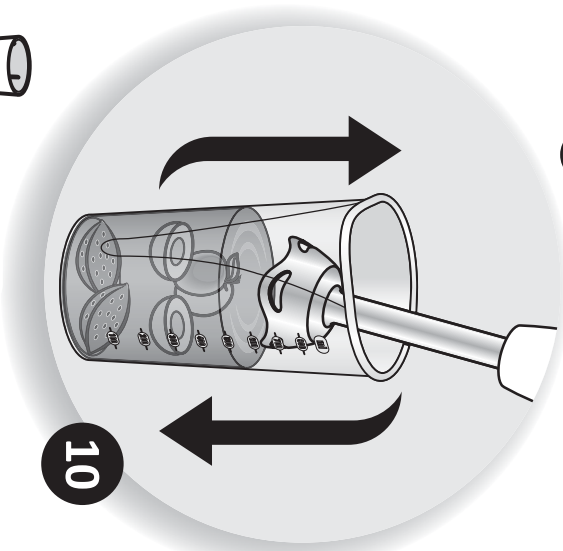

10

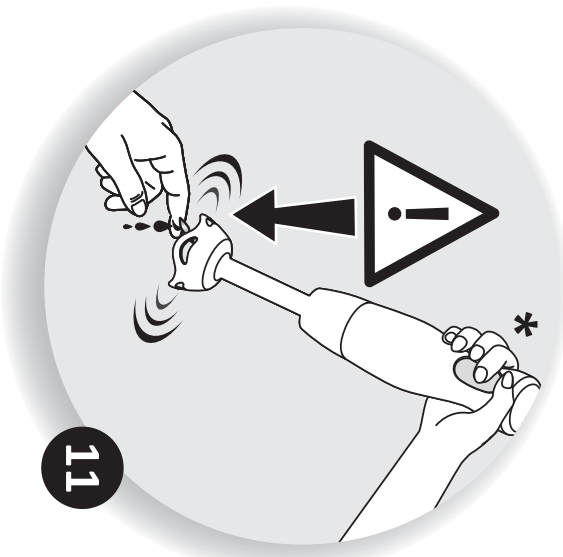

11

3

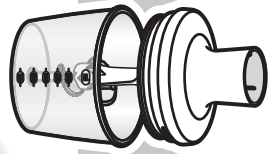

\* 500 ml

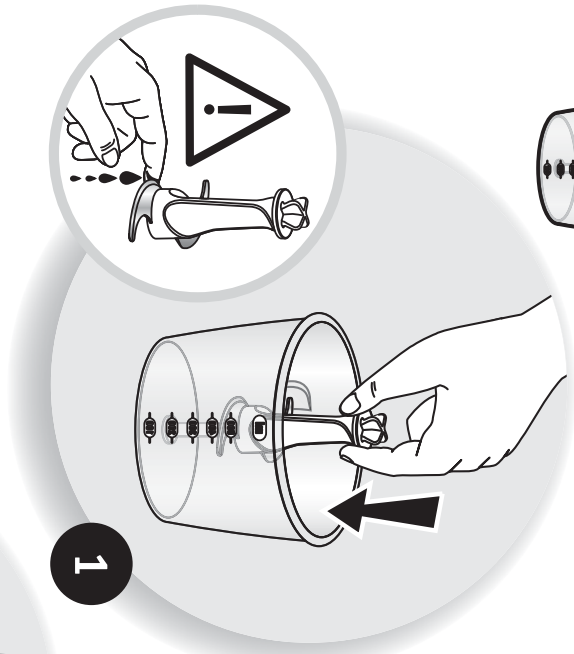

1

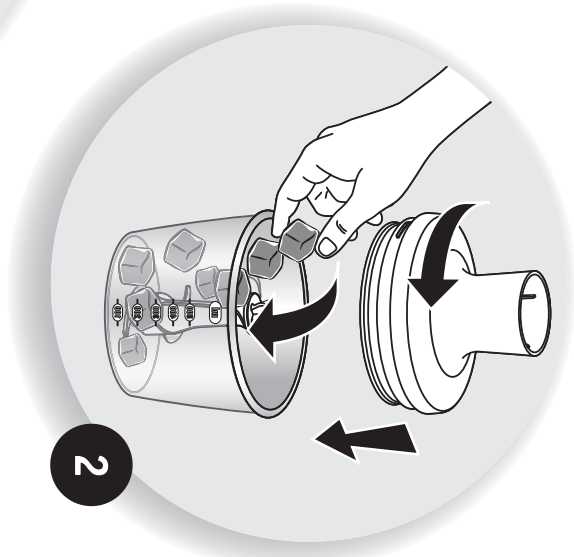

2

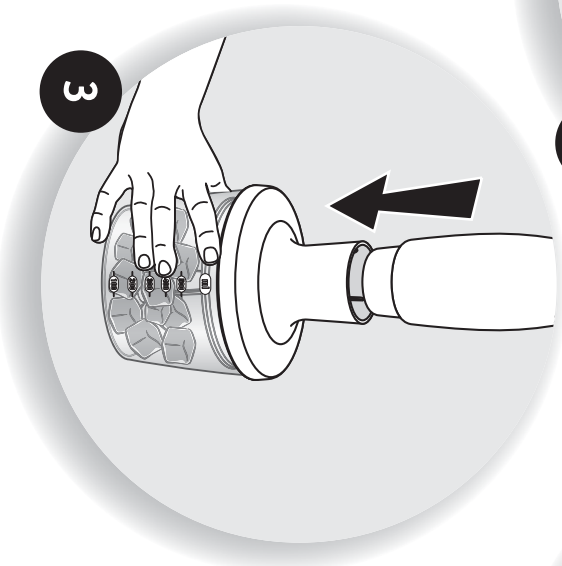

3

**4** \* 150ml

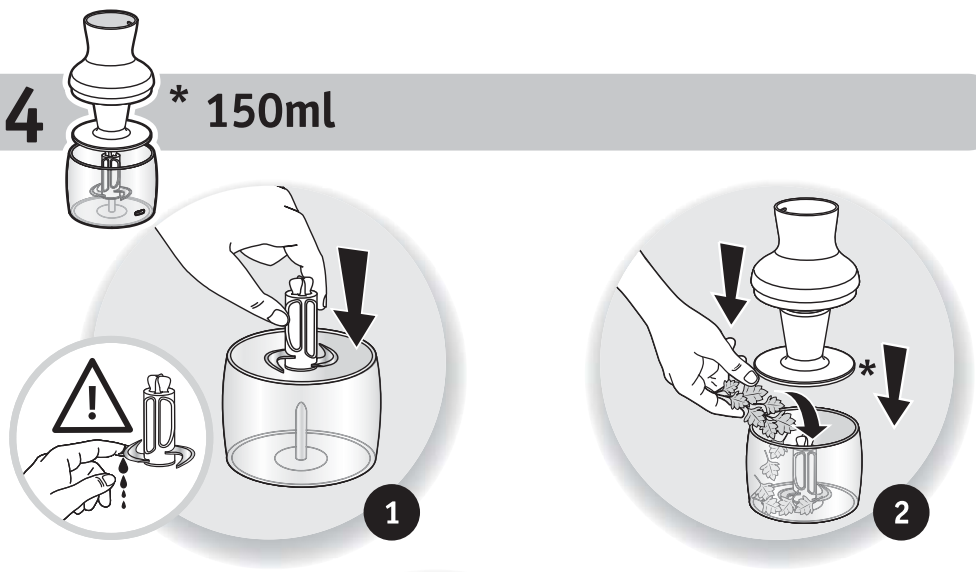



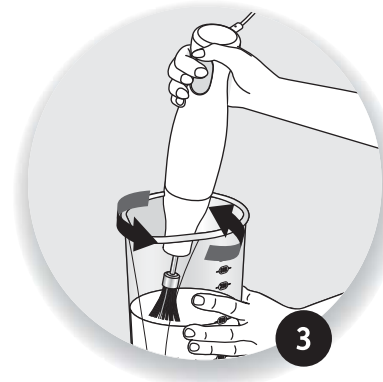
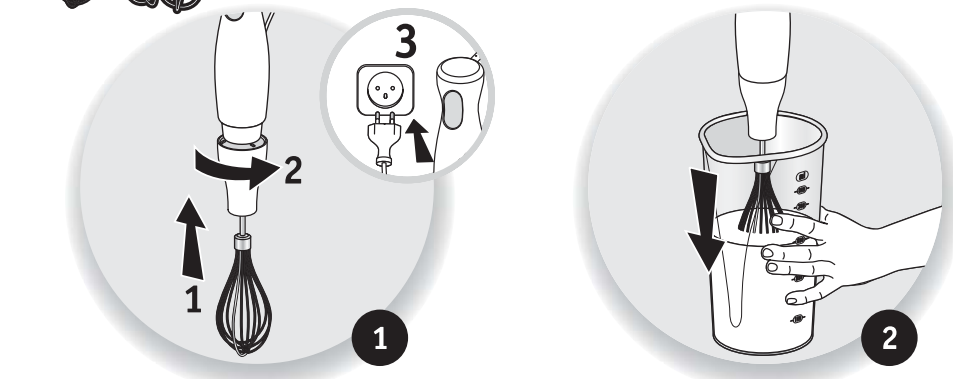

**5** \*

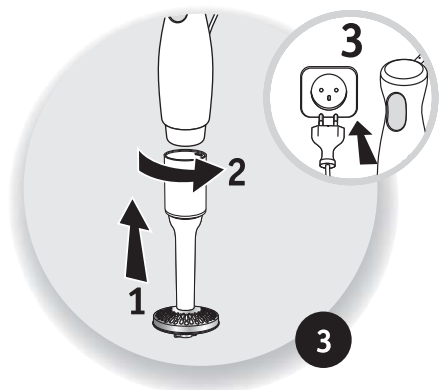
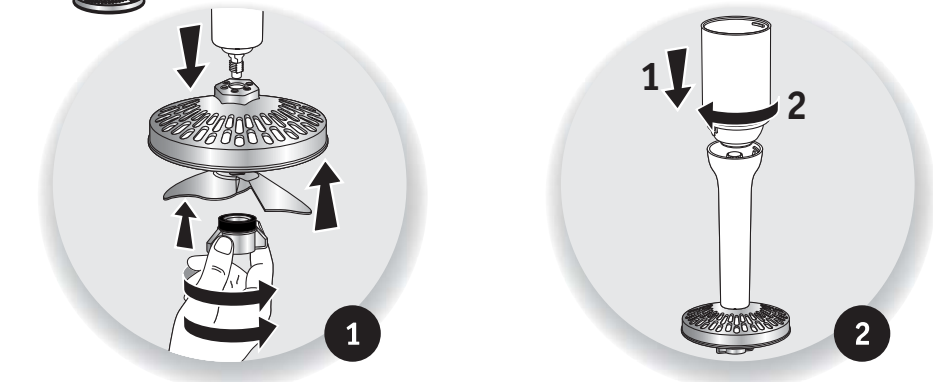



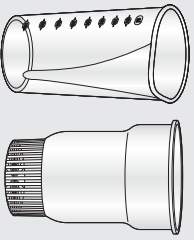
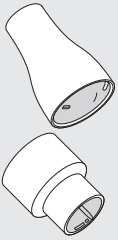

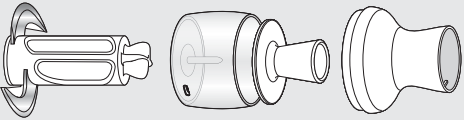
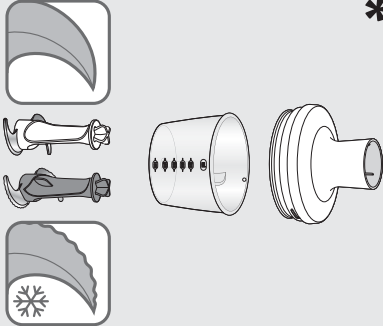
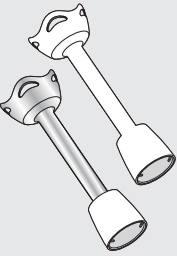
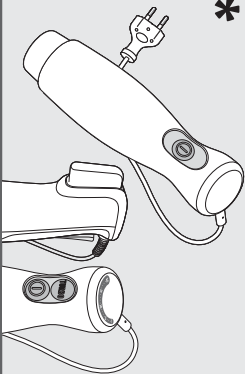
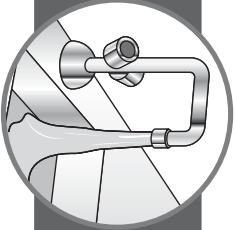
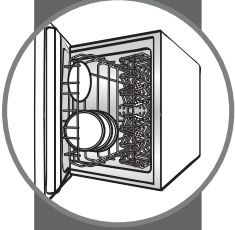



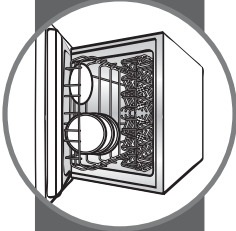
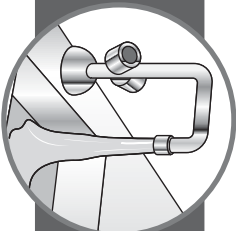



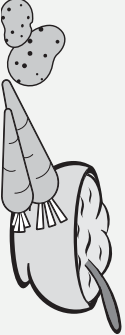
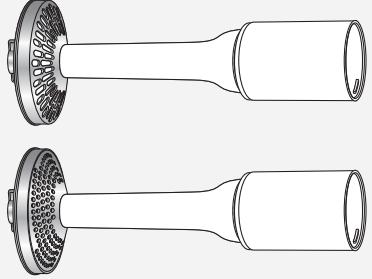

**6** \*



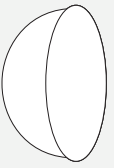





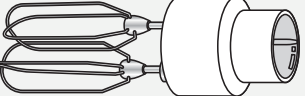

































































































































											
<p>&lt;</p>	<p>×</p>	<p>&lt;</p>	<p>&lt;</p>	<p>&lt;</p>	<p>×</p>	<p>&lt;</p>	<p>&lt;</p>	<p>×</p>	<p>&lt;</p>	<p>×</p>	
<p>&lt;</p>	<p>×</p>	<p>&lt;</p>	<p>&lt;</p>	<p>&lt;</p>	<p>×</p>	<p>&lt;</p>	<p>&lt;</p>	<p>×</p>	<p>&lt;</p>	<p>×</p>	
<p>&lt;</p>	<p>&lt;</p>	<p>&lt;</p>	<p>×</p>	<p>&lt;</p>	<p>&lt;</p>	<p>×</p>	<p>&lt;</p>	<p>&lt;</p>	<p>×</p>	<p>&lt;</p>	

	✓	✓	✓		✓		✓
	✓	✗	✗		✗		✗
	✓	✓	✓		✓		✓

							
1kg	1min	turbo					
8 	3min	turbo					
300 ml	3min	turbo					
300 ml	4min	turbo					
800 g	3min	turbo					
800 g	3min	turbo					
							5 min max

						 MAX	
* Oil 250ml =  x1 +  x1 +  +  + 	 turbo	30s		1			
	 turbo	40s	350ml				
 turbo	40s	350g					
 turbo	40s	500ml					
 turbo	30s	20g					
 turbo	40s	200g					
 turbo	15 pulses	125g					
 turbo	30s Pulse	4					
 turbo	3s	40g					
 turbo	3s	100g					
 turbo	3min	4					
 turbo	3min	200ml					
 turbo	3min	200ml					
 x1 +  x1 +  +  + 	 turbo	30s		1			
 turbo	40s	350g					
 turbo	40s	500ml					
 turbo	30s	20g					
 turbo	40s	200g					
 turbo	15 pulses	125g					
 turbo	30s Pulse	4					
 turbo	3s	40g					
 turbo	3s	100g					
 turbo	3min	4					
 turbo	3min	200ml					
 turbo	3min	200ml					
 x1 +  x1 +  +  + 	 turbo	30s		1			
 turbo	40s	350ml					
 turbo	40s	350g					
 turbo	40s	500ml					
 turbo	30s	20g					
 turbo	40s	200g					
 turbo	15 pulses	125g					
 turbo	30s Pulse	4					
 turbo	3s	40g					
 turbo	3s	100g					
 turbo	3min	4					
 turbo	3min	200ml					
 turbo	3min	200ml					
 x1 +  x1 +  +  + 	 turbo	30s		1			
 turbo	40s	350ml					
 turbo	40s	350g					
 turbo	40s	500ml					
 turbo	30s	20g					
 turbo	40s	200g					
 turbo	15 pulses	125g					
 turbo	30s Pulse	4					
 turbo	3s	40g					
 turbo	3s	100g					
 turbo	3min	4					
 turbo	3min	200ml					
 turbo	3min	200ml					
 x1 +  x1 +  +  + 	 turbo	30s		1			
 turbo	40s	350ml					
 turbo	40s	350g					
 turbo	40s	500ml					
 turbo	30s	20g					
 turbo	40s	200g					
 turbo	15 pulses	125g					
 turbo	30s Pulse	4					
 turbo	3s	40g					
 turbo	3s	100g					
 turbo	3min	4					
 turbo	3min	200ml					
 turbo	3min	200ml					
 x1 +  x1 +  +  + 	 turbo	30s		1			
 turbo	40s	350ml					
 turbo	40s	350g					
 turbo	40s	500ml					
 turbo	30s	20g					
 turbo	40s	200g					
 turbo	15 pulses	125g					
 turbo	30s Pulse	4					
 turbo	3s	40g					
 turbo	3s	100g					
 turbo	3min	4					
 turbo	3min	200ml					
 turbo	3min	200ml					
 x1 +  x1 +  +  + 	 turbo	30s		1			
 turbo	40s	350ml					
 turbo	40s	350g					
 turbo	40s	500ml					
 turbo	30s	20g					
 turbo	40s	200g					
 turbo	15 pulses	125g					
 turbo	30s Pulse	4					
 turbo	3s	40g					
 turbo	3s	100g					
 turbo	3min	4					
 turbo	3min	200ml					
 turbo	3min	200ml					



Si votre appareil ne fonctionne pas, vérifiez qu'il soit bien connecté au secteur, que le cordon soit en bon état. Votre appareil ne fonctionne toujours pas? Adressez-vous à un centre service agréé (voir liste dans le livret service).

If your appliance does not work, check it is properly connected to the mains and the power cord is in good condition. Your appliance still does not work? Contact an approved service centre (see the service booklet).

Sollte Ihr Gerät nicht funktionieren, überprüfen Sie, ob es ordnungsgemäß an die Stromversorgung angeschlossen ist und ob das Kabel in einwandfreiem Zustand ist. Ihr Gerät funktioniert immer noch nicht? Wenden Sie sich an einen autorisierten Kundendienst (siehe Liste im Serviceheft).

Als uw apparaat niet werkt, controleer dan of het goed op het elektriciteitsnet is aangesloten en of het snoer niet beschadigd is. Werk het apparaat nog steeds niet? Neem dan contact op met een erkend servicecentrum (zie de lijst in het serviceboekje).

Se l'apparecchio non funziona, verificate che sia ben collegato alla rete elettrica e che il cavo sia in buono stato. L'apparecchio continua a non funzionare? Rivolgervi ad un centro di assistenza autorizzato (vedere l'elenco nel libretto).

Si su aparato no funciona, asegúrese de que está bien conectado a la red eléctrica y que el cable está en buen estado. ¿Su aparato sigue sin funcionar? Diríjase a un servicio técnico autorizado (ver la lista en el folleto de servicio).

Caso o aparelho não esteja funcionar, certifique-se de que está corretamente ligado à corrente e que o cabo de alimentação se encontra em perfeitas condições de utilização. O seu aparelho continua sem funcionar? Contacte um Serviço de Assistência Técnica autorizado (consulte a lista no folheto de Serviços de Assistência Técnica).

Εάν η συσκευή σας δεν λειτουργεί, βεβαιωθείτε ότι έχει συνδεθεί σωστά στην πρίζα και ότι το καλώδιο βρίσκεται σε καλή κατάσταση. Η συσκευή σας εξακολουθεί να μη λειτουργεί; Απευθυνθείτε σε ένα εξουσιοδοτημένο κέντρο σέρβις (βείτε τη λίστα στο φυλλάδιο σέρβις).

Hvis apparatet ikke virker, kontroller om det er tilsluttet netforsyningen. Virker apparatet stadig ikke? Kontakt et autoriseret serviceværksted (se listen i servicehæftet).

Om apparaten inte fungerar, kontrollera att den är ansluten till elnätet och att sladden är i gott skick. Vad gör jag ifall apparaten fortfarande inte fungerar? Vänd dig till ett auktoriserat servicecenter (se listan i servicehäftet).

Jos laite ei toimi, tarkasta, että siihen on kytketty virta oikein ja että johto on kunnossa. Eikö laitteesi vieläkään toimi? Ota yhteyttä valtuutettuun huoltorähtöluon (katso yhteyshetod huoltokirjasesta).

Dersom apparatet ikke virker, sjekk at det er koblet til strømmettet, og at ledningen er i god stand. Fungerer apparatet fortsatt ikke? Kontakt et godkjent serviceverksted (se listen i servicehåndboken).

Sihazınız çalışmıyorsa, elektrik şebekesine doğru şekilde bağlanıp, kablusunun çalıgır durumda olduğunu dogrulaın. Sihazınız hala çalışmıyormu? Yetkili bir servis merkezine başvurun (servis kitarçığındaki listeye bakınız).

Если ваш прибор не работает, проверьте, правильно ли он подключен к сети, исправен ли шнур. Прибор по-прежнему не работает? Обратитесь в аккредитованный центр технического обслуживания (см. список в паспорте изделия).

Якщо прилад не працює, переконайтеся, що він правильно підключений до мережі та шнур у доброму стані. Прилад усе одно не працює? Зверніться в один з акредитованих центрів технічного обслуговування (див. список у паспорті виробу).

Егер құрылғын жұмыс істемесе, құрылғының қуат көзіне дұрыс қосылғанын және қуат сымының күйін тексеріңіз. Құрылғы мүлдем жұмыс істемей ме? Тісті қызмет көрсету орталығына хабарласыңыз (қызмет көрсету нұсқаулығында берілген тізімді қараңыз).

Dasă aparatul dımneaoastră nu funcționează, verificați ca acesta să fie racordat coreșpunzător la rețeaua de alimentare și cablul să fie în stare bună. Aparatul dımneaoastră tot nu funcționează? Adresați-vă unui centru de service agreat (a se vedea lista din cartelul de service).

Се нарвага не делује, преверите, али је кабел правилно прикључен в електрично омреже, озигма се преричаје, да кабел ни рошкодован. Ваша нарвага се ведно не делује? Обрните се на рооблашени сервисни центер (глејите seznam v servisni knjižici).

Ako váš aparát ne radi, overte, či je správne pripojen na elektrickú sieť a či je kábel v dobrom stave. Aký aparát a či je kábel v dobrom stave? Obráťte sa na odborníka (pozrite si zoznam poskytovateľov služieb).

Ako upraviť rádio, overte, či je správne pripojen a či je kábel v dobrom stave. Aký aparát a či je kábel v dobrom stave? Obráťte sa na odborníka (pozrite si zoznam poskytovateľov služieb).

Ako váš aparát ne radi, overte, či je správne pripojen na elektrickú sieť a či je kábel v dobrom stave. Aký aparát a či je kábel v dobrom stave? Obráťte sa na odborníka (pozrite si zoznam poskytovateľov služieb).

Ако уредът Ви не работи, проверете дали е правилно свързан със захранването и дали кабелът е в добро състояние. Ако уредът продължава да не работи: Обърнете се към оторизиран сервизен център (виж списък в книгата за експлоатация).

Kui teie seade ei tööta, veenduge, et see oleks korralikult vooluvõrku ühendatud ja et juhe oleks heas seisukorras. Teie seade ei tööta ikka? Pöörduge volitatud teenindusettevõtte poole (tutvuuge nende loeteluga kasutusjuhendis).

Ja ierice nedarbojas, pārbaiciet, ka tā ir pieslēgta tīklam un ka vads nav bojāts. Vai ierice joprojām nedarbojas? Varsieties sertificētā servisa centrā (to saraksts pievienots).

Jeigu jūsų prietaisas neveikia, patikrinkite, ar jis tinkamai prijungtas prie sektoriaus ir ar maitinimo laidas yra tinkamos būklės. Prietaisas vis tiek neveikia? Kreipkitės į patvirtintas remonto dirbtuves (žr. sąrašą aptarnavimo knygelėje).

Jeżeli urządzenie nie działa, sprawdź, czy jest ono prawidłowo podłączone do sieci elektrycznej i czy kabel nie jest uszkodzony. Urządzenie nadal nie działa? Prosimy o kontakt z autoryzowanym punktem serwisowym (zob.: lista w książce gwarancyjnej).

Pokud váš prístroj nefunguje, overte si, zda je správne zapojen do siete a zda je kábel v dobrom stave. Aký prístroj a či je kábel v dobrom stave? Obráťte sa na smluvní servisní středisko (viz seznam v servisní knize).

Ak váš prístroj nefunguje, skontrolujte, či je správne zapojený do zásuvky a či je kábel v poriadku. Zariadenie stále nefunguje? Obráťte na autorizované servisné stredisko (pozrite si zoznam v servisnej knižke).

a készülék nem működik, ellenőrizze, hogy megfelelően van-e csatlakoztatva, és hogy a kábel jó állapotban van-e. A készülék továbbra sem működik? Ez esetben forduljon a közeli hivatalos szakszervizhez (a szervizlistát ld. a szervizkönyvben).

หากเครื่องใช้ไฟฟ้าของคุณไม่ทำงาน ให้ตรวจสอบว่าติดตั้งหรือใช้ หรือสายไฟอยู่ในสภาพดีหรือไม่  
ถ้าเครื่องใช้ไฟฟ้าของคุณยังไม่สามารถใช้งานได้  
โปรดติดต่อศูนย์บริการที่ใกล้บ้านของคุณ  
(ดูรายชื่อศูนย์บริการจากคู่มือการบริการ)

기기가 작동하지 않을 경우, 전원 연결 및 전선 상태를 확인하십시오. 기기가 여전히 작동하지 않습니까? 이 경우 공인 서비스 센터에 문의하십시오 (서비스 책자 내 리스트를 참조)

Nếu thiết bị của bạn không hoạt động, hãy chắc chắn rằng nó đã được kết nối đúng với nguồn điện, dây điện trong tình trạng tốt. Thiết bị của bạn vẫn không hoạt động? Xin vui lòng liên hệ với trung tâm dịch vụ ủy quyền (xem danh sách trong cuốn sổ tay).

如果您的設備未能正常運作，請檢查是否已經插電，並檢查線路是否是正常狀態。如果設備依然無法運作，請聯繫授權服務中心（詳情請參閱清單中的服務手冊）。

Jika perkakas anda gagal berfungsi, pastikan kabel kuasa diplagkan dengan betul dan pastikan kabel kuasa berada dalam keadaan yang baik. Adakah perkakas anda masih berfungsi? Sila hubungi pusat perkhidmatan yang diluluskan (sila rujuk senarai dalam buku panduan).

إذا لم يعمل الجهاز الخاص بك، فُيرجى التحقق من أنه متصل بشكل صحيح بالتيار الكهربائي ومن أن الكابل في حالة جيدة. هل الجهاز الخاص بك لا يزال لا يعمل؟ يُرجى الاتصال بمركز مُعتمد لخدمة العملاء (انظر القائمة في كتيب الخدمة).

در صورتی که دستگاه شما کار نمی کند، مطمئن شوید دستگاه به برق وصل است و سیم برق در وضعیت مناسبی قرار دارد. آیا دستگاه شما هنوز کار نمی کند؟ لطفاً با مرکز خدمات مجاز تماس بگیرید (لیست مراکز مجاز در همین دفترچه ارائه شده است).