

BUSH

Instruction manual

VL32HDLED



You'll soon be enjoying your new TV.

It all begins here, with your instructions. Don't worry, there's nothing too technical coming up. Just simple, step-by-step guidance to get you up and running quickly. Sound good? Then let's get started.

Help and Guidance

We're here to help you get the most from your television. Should you require any guidance, a simple solution can often be found online at:

www.bush-support.com

If you still require further assistance, call one of our experts on **0345 604 0105**.

Contents

| | | | |
|----------|---|----|----|
| 1 | Safety information | | |
| 2 | Getting to know your TV | | |
| | Ready? Let's begin... | 10 | |
| | Accessories | 10 | |
| | Installing / Removing the Base Stand | 11 | |
| | Wall Mounting Installation Guidelines | 11 | |
| | Viewing remote control | 12 | |
| | Viewing control panel | 13 | |
| | Viewing back panel | 14 | |
| | Aerial connection | 15 | |
| | Power connection | 15 | |
| | Remote control - Inserting batteries | 15 | |
| | Switching the TV On and Off | 15 | |
| | Operation using TV control buttons | 16 | |
| | Operation using remote control | 16 | |
| | Initial setup | 17 | |
| 3 | Connections | | |
| | Left bottom connections explained | 20 | |
| | Left side connections explained | 21 | |
| | HDMI Connections | 22 | |
| | SCART Connections | 22 | |
| 4 | Standard features | | |
| | How to navigate menus - Selecting source | 26 | |
| | Electronic programme guide (EPG) (DTV mode) | 26 | |
| | Teletext (ATV mode) | 27 | |
| | Digital Teletext (DTV mode) | 28 | |
| | Recording DTV Programme onto a USB Storage Device | 28 | |
| | Timer Programming | 29 | |
| | Play Recorded Programme | 30 | |
| | Quick Settings management (ATV / DTV Mode) | | 30 |
| 5 | Other information | | |
| | Specifications | | 40 |
| | Digital reception | | 40 |
| | Plug replacement - UK and Ireland only | | 41 |
| | Energy label | | 41 |
| | DTS TruSurround | | 41 |
| | HDMI | | 41 |
| 6 | Product support | | |
| | Trouble shooting | | 44 |
| | Supported file formats | | 45 |
| | Disposal information | | 46 |
| | Help and assistance | | 47 |
| | Guarantee | | 48 |

Safety information

1





Safety information

Important - Please read these instructions fully before installing or operating

Power source

The TV should be operated only from a 100-240V~50/60Hz outlet.

 **AC voltage:** Rated voltage marked with this symbol is AC voltage.

- **Warning: Do not** leave your TV in standby or operating mode when you leave your house.

Positioning the TV

This product is intended for indoor use only. For ventilation, please leave a clear space of at least 10cm all around the TV.(Fig 1)

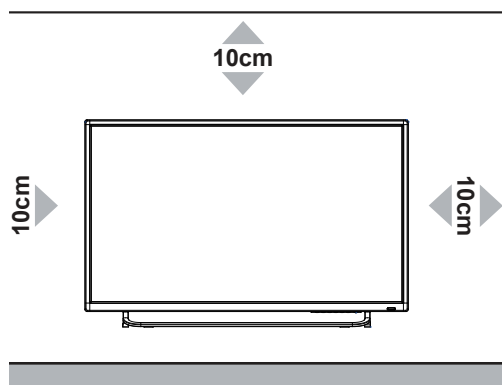

Fig 1.

- **Do not** block the ventilation openings.
- **Do not** place the TV on sloping or unstable surfaces, the TV may tip over.
- To prevent damage to the TV, do not place any objects on top of the TV.
- Only use the TV in moderate climates.

Power cord and plug

- The power cord plug should be easily accessible. In case of storms and lightning, when going on holiday, or when the TV is not used for a long period of time disconnect the power cord from the mains power socket.
- **Do not** place the TV, furniture, etc. on the power cord or pinch the cord.
- Handle the power cord by the plug, do not unplug the TV by pulling the power cord.

- Never touch the power cord/plug with wet hands as this could cause a short circuit or electric shock.
- Never make a knot in the power cord or tie it with other cords.
- Power cords should be placed in such a way that they are not likely to be stepped on or driven over.
- A damaged power cord/plug can cause fire or give you an electric shock. When damaged it must be replaced, this should only be done by qualified personnel.

Moisture and water

- **Do not** use this TV in a humid or damp place (avoid bathrooms, the sink in the kitchen, and near the washing machine).
- **Do not** expose this TV to rain or water, as this may be dangerous.
- **Do not** place objects filled with liquids, such as flower vases, on top of the TV. Avoid from dripping or splashing.
- If any solid object or liquid falls into the cabinet, unplug the TV and have it checked by qualified personnel before operating it any further.

Ventilation

- The slots and openings on the TV set are intended for ventilation and to ensure reliable operation.
- To prevent overheating, these openings must not be blocked or covered in anyway.

Heat sources and flames

- **Do not** expose the TV to direct sunlight or other heat sources.
- The TV should not be placed near to open flames and sources of intense heat such as an electric heater.
- Ensure that no open flame sources, such as lighted candles, are placed on top of the TV.



- **Warning: To prevent the spread of fire, keep candles or other open flames away from this product at all times.**

If you require any technical guidance or find that your product is not operating as intended, a simple solution can often be found in the **Troubleshooting** section of these instructions,



Safety information

Important - Please read these instructions fully before installing or operating



- To reduce the risk of electric shock, do not remove cover (or back). No user-serviceable parts inside. Refer servicing to qualified service personnel.



- The exclamation point within an equilateral triangle is intended to alert the user to the presence of important operating and maintenance (servicing) instructions in the literature accompanying the appliance.



- The lightning flash with arrowhead symbol, within an equilateral triangle, is intended to alert the user to the presence of uninsulated "dangerous voltage" within the product's enclosure that may be of sufficient magnitude to constitute a risk of electric shock of persons.

Headphone volume

Excessive sound pressure from earphones and headphones can cause hearing loss, please take care.

Wall mounting (optional)

- To prevent injury, this TV must be securely attached to the wall in accordance with the installation instructions (if the option is available).
- Do not install the TV on a ceiling or on an inclined wall.

LCD Screen

- The LCD screen is a very high technology product with about a million thin film transistors, giving you fine picture details. Occasionally, a few non-active pixels may appear on the screen as a fixed blue, green or red point. Please note that this does not affect the performance of your product.
- Take care not to scratch the screen with fingernails or other hard objects.

Cleaning

- Before cleaning, unplug the TV from the wall socket.
- **Do not** use liquid or aerosol cleaners. Only use a soft, dry cloth.

Batteries

Warning: Incorrect installation of batteries may cause battery leakage and corrosion, resulting in damage to the remote control.

Do not mix old and new batteries, or batteries of different types.

Do not dispose of batteries with normal household waste, take to a local recycling centre.

The batteries shall not be exposed to excessive heat such as sunshine, fire or the like.



Children may not recognize dangers. The swallowing of batteries can be fatal. Keep batteries always out of reach of small children. If a battery is swallowed, seek immediate medical attention.

Replacement parts

When replacement parts are required, make sure that the service technician has used replacement parts, which are specified by the manufacture or have the same specifications as the original one. Unauthorised substitutions may result in fire, electrical shock or other hazards.

Servicing

- Warning: Risk of electric shock, **do not** attempt to repair, service or modify this TV yourself. Contact the manufacturer, their approved service agent or the **Customer Helpline: 0345 604 0105.**

Markings on the Product



This equipment is a Class II or double insulated electrical appliance. It has been designed in such a way that it does not require a safety connection to electrical earth.

Getting to know your TV

2



Getting to know your TV

You'll be up and running in no time

Ready? Let's begin...

Please read these instructions carefully. They contain important information which will help you get the best from your TV and ensure safe and correct installation and operation.

If you require any further assistance, our technical experts are happy to help. For full details, refer to the product support section at the end of these instructions.

Accessories

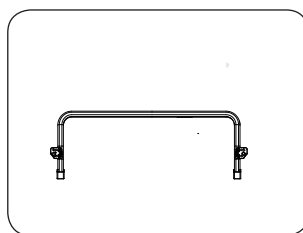

Stand Base

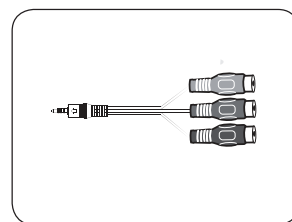

MINI YPBPR Cable

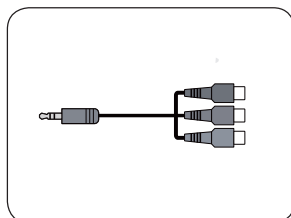

MINI AV Cable



Remote Control

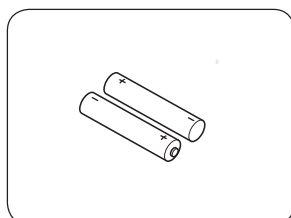

Batteries: 2 x AAA

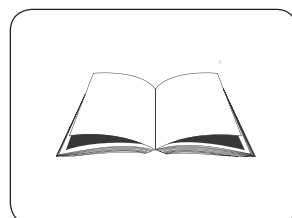

Instruction Book

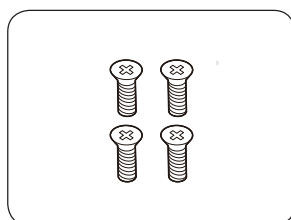

Screws

If you require any technical guidance or find that your product is not operating as intended, a simple solution can often be found in the **Troubleshooting** section of these instructions,

Getting to know your TV

You'll be up and running in no time

Installing / Removing the Base Stand

Base Stand Assembly Instruction

1. Lay the TV flat on a table with the LED screen face down. To prevent the TV from being scratched, put a piece of soft cloth on the table on which the screen will be set.
2. Place the base in position as shown. Insert and tighten 4 screws (provided) into pedestal holes as shown.

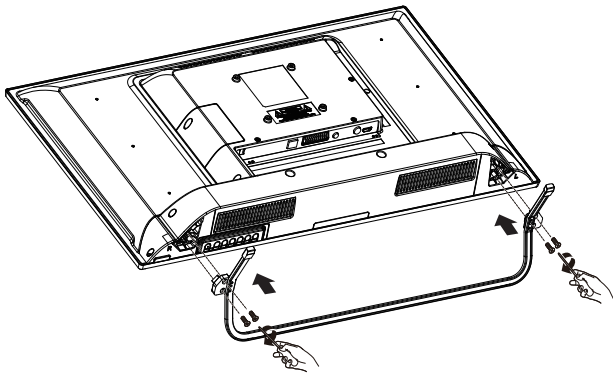

Wall Mounting Installation Guidelines

1. Lay the TV flat on a table with the LED screen face down. To prevent the TV from being scratched, put a piece of soft cloth on the table on which the screen will be set.
2. Remove the 4 screws .
3. Remove the stand.

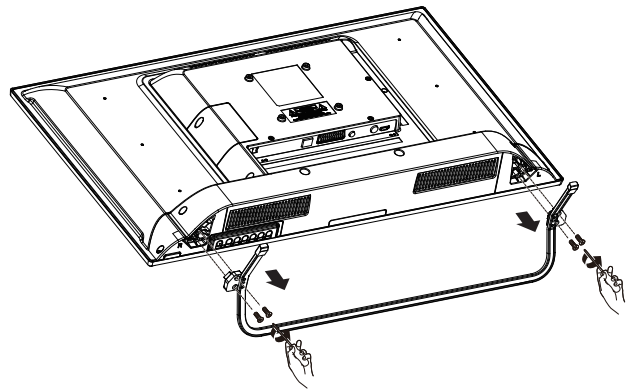

INSTALLATION NOTES

This TV can be connected to an AC 100-240 Volts, 50/60 Hz power supply. Never connect straight to a DC power supply.

Locate the TV in a room where light does not strike the screen directly. Total darkness or a reflection on the screen can cause eyestrain. Soft and indirect lighting is recommended for comfortable viewing.

Allow enough space between the TV and the wall to permit ventilation.

Avoid excessively warm locations to prevent possible damage to the cabinet or premature component failure.

4. Use the four screws (4*10mm, not included) to fix the TV onto a wall mounting bracket (not included) via the four VESA standard holes on the back of the television.

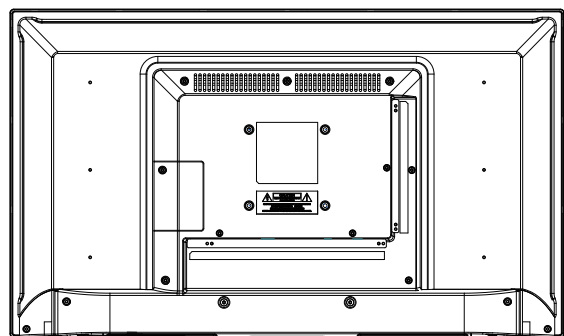

100 x 100mm VESA mount

Getting to know your TV

You'll be up and running in no time

Viewing remote control

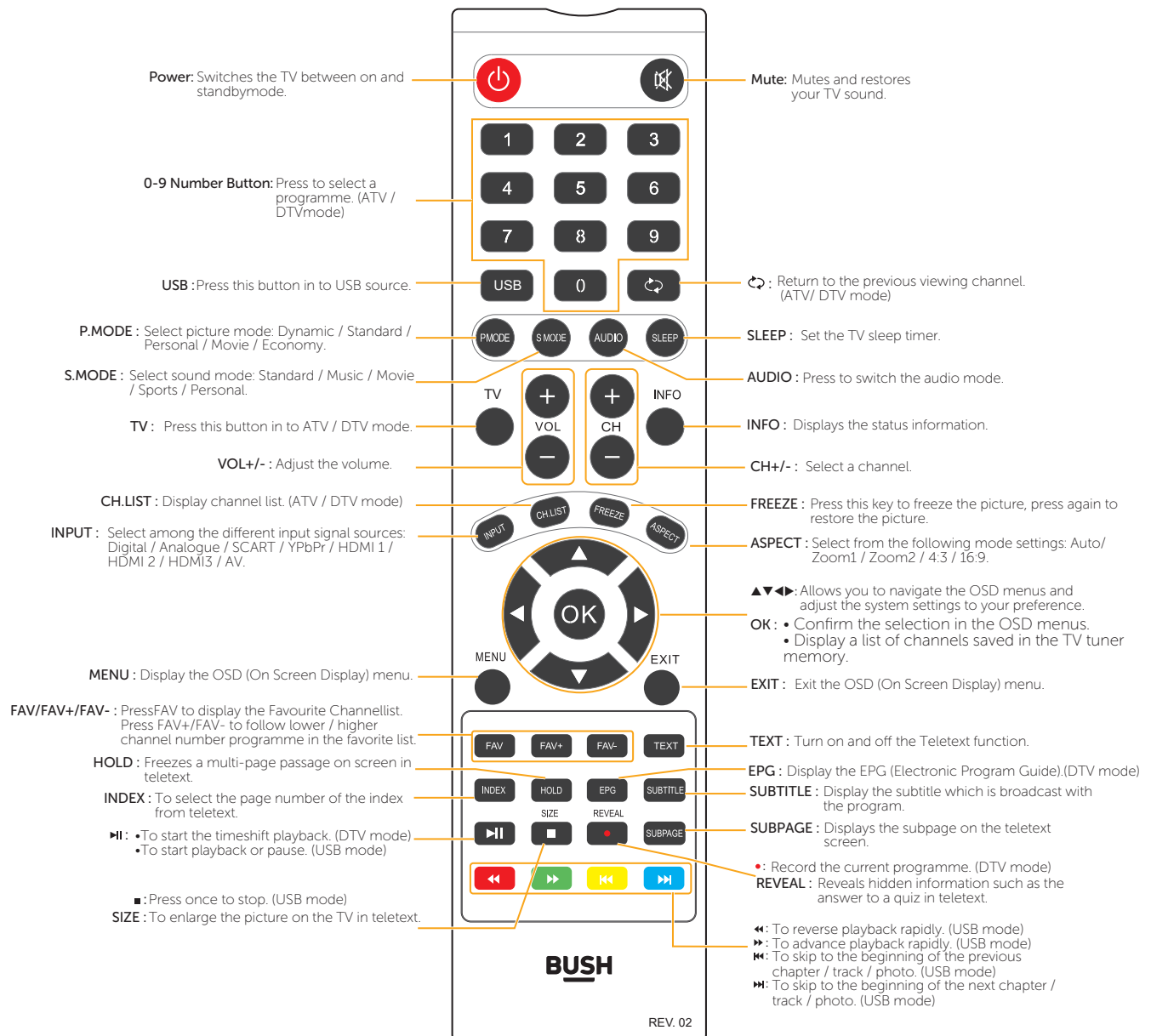

If you require any technical guidance or find that your product is not operating as intended, a simple solution can often be found in the **Troubleshooting** section of these instructions,

Getting to know your TV

You'll be up and running in no time

Viewing control panel



1. VOL+ Increase the volume
2. VOL- Decrease the volume
3. CH▲ Selects the next channel up
4. CH▼ Selects the next channel down
5. INPUT Accesses the Source menu
6. MENU Accesses the TV menus
7. POWER Turns the TV on and into standby
8. Standby LED/Remote Control Sensor

Getting to know your TV

You'll be up and running in no time

Viewing back panel

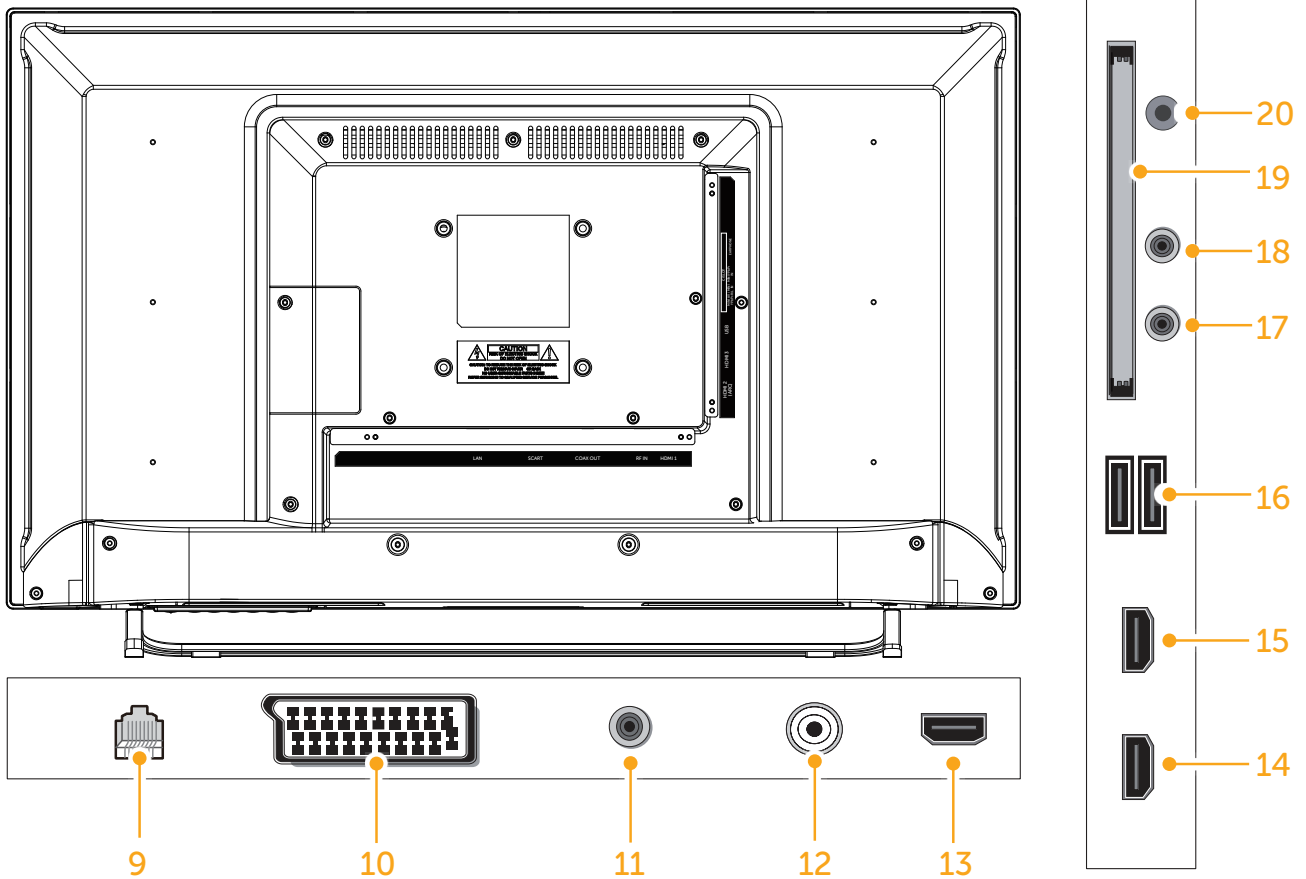

9. LAN

10. SCART Socket SCART lead connection

11. COAXIAL Out

12. RF Input (ANT.)

13. HDMI1 Socket High Definition lead connection

14. HDMI2 Socket High Definition lead connection

15. HDMI3 Socket High Definition lead connection

16. USB Socket USB connection (optional)

17. MINI AV/YPbPr-R/L

18. MINI YPbPr

19. CI Slot

20. Headphone jack

If you require any technical guidance or find that your product is not operating as intended, a simple solution can often be found in the **Troubleshooting** section of these instructions,

Getting to know your TV

You'll be up and running in no time

Aerial connection

Connect a coaxial cable (not provided) to the ANT/CABLE IN jack on the back of your TV and to the antenna or cable TV wall jack.

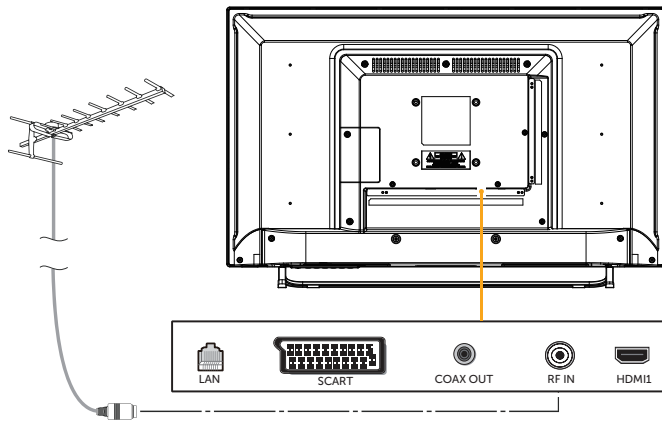

Connect the incoming cable from the cable wall jack to the cable-in jack on the cable or satellite box. Connect a coaxial cable (not provided) to the ANT/CABLE IN jack on the side of your TV and to the coaxial out jack on the cable or satellite box.

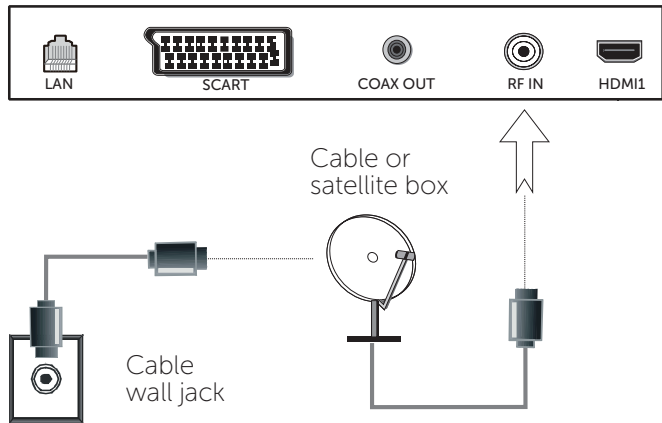

Power connection

Connect the power cord plug to the mains power socket.

Please note: After unpacking, allow the TV to reach ambient room temperature before connecting the TV to the mains power socket.

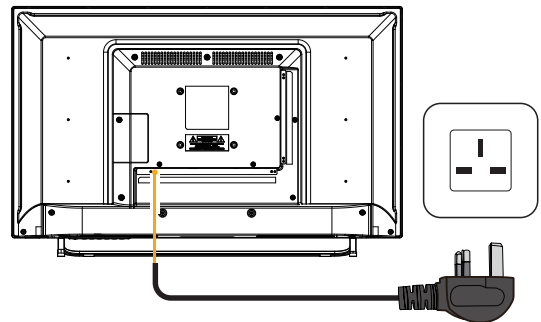

Remote control - Inserting batteries

Remove the battery cover on the back of the remote control, gently push down and pull backwards at the same time as shown.

Insert two AAA/R3 or equivalent type batteries. Ensure the batteries are inserted the correct way and replace the battery cover.

Note: When the remote control is not going to be used for long periods of time, the batteries should be removed. Otherwise the remote control may be damaged, caused by battery leakage and corrosion.

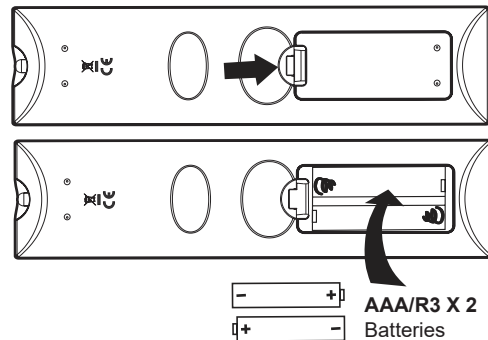

Switching the TV On and Off

Switching the TV On

With power cord plug connected to the mains power socket and TV in 'Standby' mode.

To switch the TV on from standby mode, either:

- a: **The Remote control;** Press the "⏻" button.
- b: **The TV;** Press the "⏻" button on the front bezel of the TV.

Switching the TV Off

Either press the "⏻" button on the remote control or press the "⏻" button on the front bezel of the TV, the TV will then switch to standby mode.

Getting to know your TV

You'll be up and running in no time

Operation using TV control buttons

The **VOL+/VOL-** buttons will function as volume up/down as default. Even if you set other functions for these buttons, the **VOL+/VOL-** buttons will return to volume control after a short while.

Volume Setting

Press **VOL+/VOL-** buttons to increase or decrease volume.

Programme Selection

Press **CH▲/CH▼** buttons to select the next or previous programme.

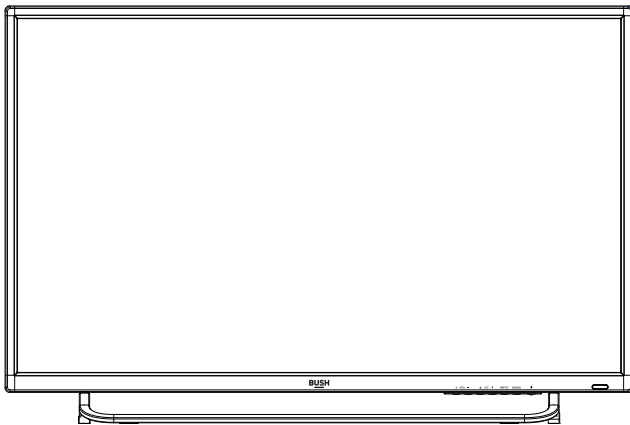

Operation using remote control

The remote control is designed to control all the functions of the model you selected.

Volume Setting

Press **VOL+** button to increase the volume.

Press **VOL-** button to decrease the volume. A volume level scale (slider) will be displayed on the screen.

Programme Selection (Previous or Next Programme)

Press **CH-** button to select the previous programme.

Press **CH+** button to select the next programme.

Programme Selection (Direct Access)

Press number buttons on the remote control to select programmes between 0 and 9. The TV will switch to the selected programme.



If you require any technical guidance or find that your product is not operating as intended, a simple solution can often be found in the **Troubleshooting** section of these instructions,

Getting to know your TV

You'll be up and running in no time

Initial setup

1. Connect one end of the RF coaxial cable to the aerial socket on the wall and the other end of the cable to the RF (75Ω) socket at the bottom of your TV.

2. Connect the mains cable to the mains socket after you have completed all the connections.

3. With power cord plug connected to the mains power socket and TV in 'Standby' mode. At this stage, the TV switches to standby mode. The red LED indicator will illuminate on the front panel of the TV.

4. In standby mode, press the "⏻" button on the front bezel of the TV or the "⏻" button on the remote control to turn the TV on. The red LED indicator will turn blue.

5. The first time you turn the TV on, please ensure the TV is connected to the aerial, then press the **OK** buttons for the next setup.

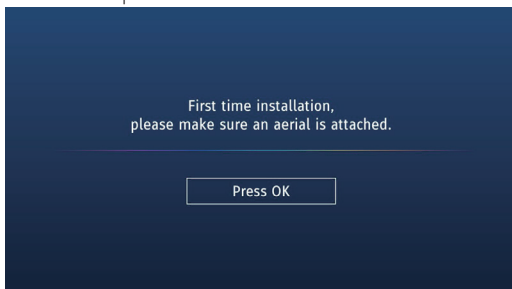

6. Select your language.

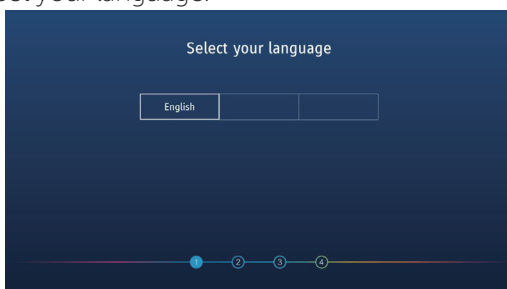

7. Press the ◀ ▶ buttons to select your country.

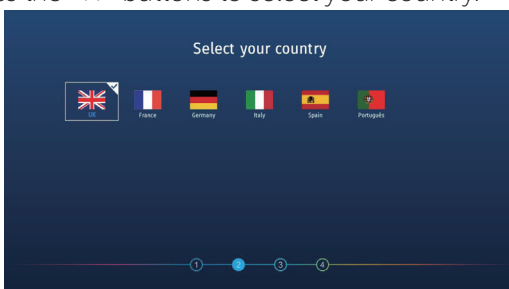

8. Press the ◀ ▶ buttons to select the environment.

- Home Mode: Viewing at home.
- Store Mode: For store demo, the brightness is higher than home mode.

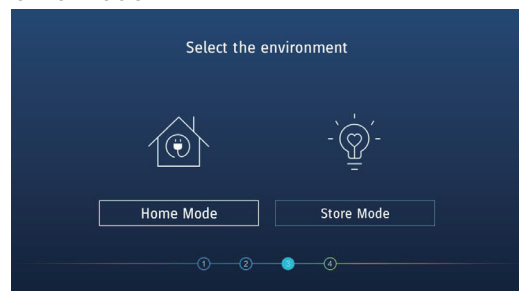

9. Press the ▲ ▼ ◀ ▶ buttons to select the default source.

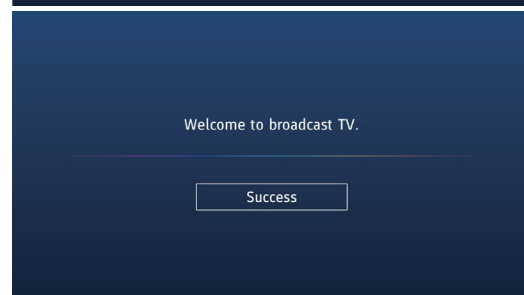
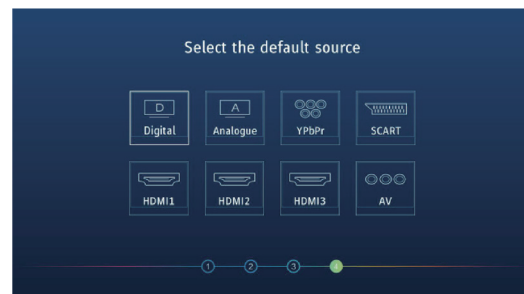

Connections

3



Connections

Bringing it all together

Left bottom connections explained

1. LAN

To use the wired network connection, connect an RJ-45 Ethernet cable (not included) from the jack on the back of your TV to your network router. When connected to the network, it has only two functions:

- Update network time.
- OTA(Over-the-Air Technology) will use it to update software.

2. SCART socket

Inputs or outputs for external devices. Connect the SCART cable between the SCART socket on the TV and the SCART socket on the external device (decoder, VCR or DVD player).

Note: If an external device is connected via the SCART socket, the TV will automatically switch to SCART mode.

3. COAXIAL

Connect to the digital audio input socket on a digital / standard 5.1 audio system.

4. RF Input (ANT.)

Connects to aerial (antenna) or cable TV. If you use a decoder or a media recorder, you should connect the aerial cable through the device to the TV with an appropriate aerial cable.

5. HDMI Input

Connects a device that has an HDMI socket. The TV can display High Definition pictures from devices such as a High Definition Satellite Receiver or DVD Player. These devices must be connected via the HDMI sockets or Component Socket. No sound connection is needed for an HDMI to HDMI connection.

Note: For HDMI 2 only

In addition to normal HDMI and HDMI-DVI functionality, it outputs TV audio to an HDMI-ARC compliant device, such as a soundbar / home theatre system.

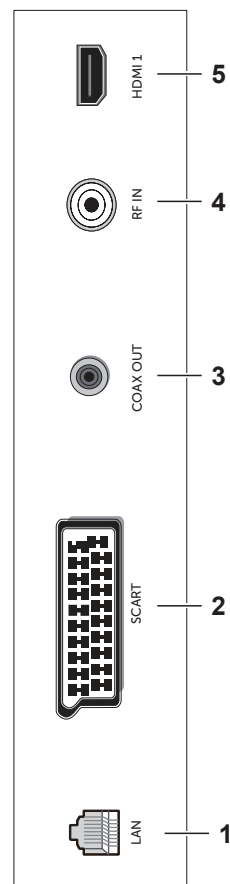
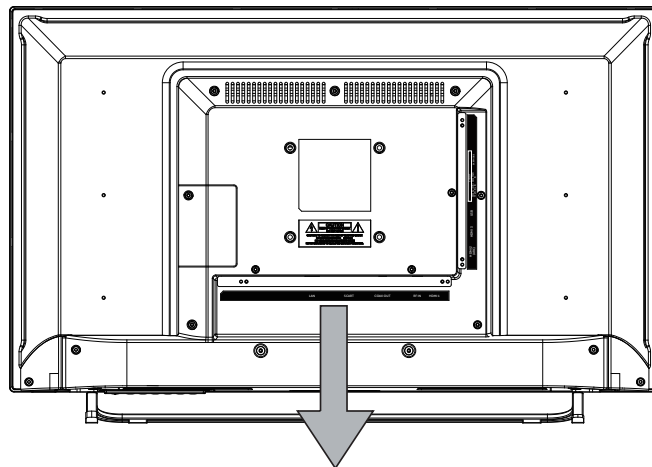

Connections

Bringing it all together

Left side connections explained

6. USB Input

To connect devices to the TV, providing fast data exchange. USB will have function in USB/DTV mode.

7. MINI AV/YPbPr-R/L

Connect to the composite VIDEO and AUDIO (R/L) output sockets on external video devices.

8. MINI YPbPr

YPbPr Input socket is just suitable for YPbPr Mini Cable. Connect to a DVD player, Digital Set-Top-Box, or other AV devices with component (YPbPr) video output sockets.

Note: Pls. use "MINI AV/YPbPr-R/L" socket, when you want to connect to YPbPr audio.

9. CI Slot

Used to insert a CI card. A CI card allows you to view all the channels that you subscribe to. For more information, see "Common Interface" section.

10. Headphone jack

To connect an external headphone to the TV. Connect to the HEADPHONE jack to listen to the TV from headphones. **Note:** Headphone volume can be changed using "VOL+" or "VOL-" buttons.

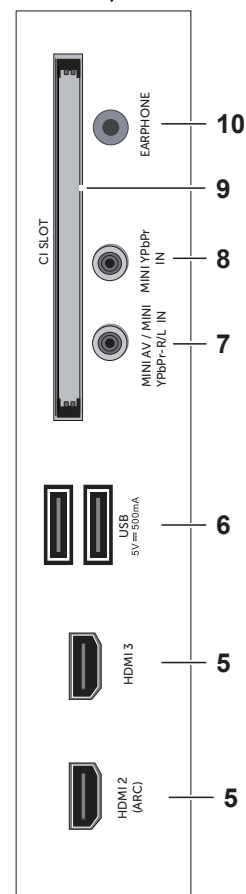
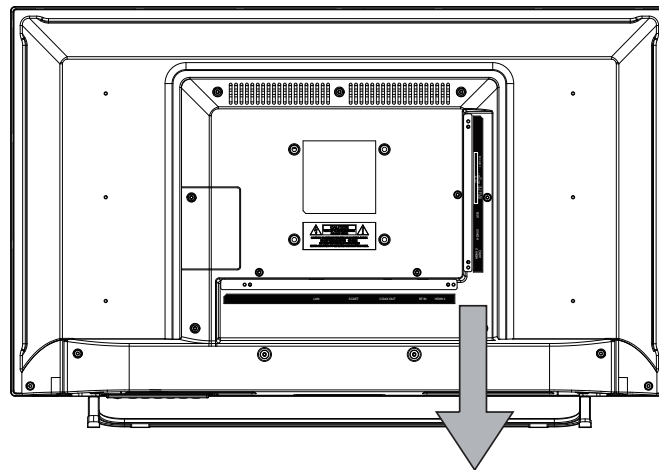

Connections

Bringing it all together

HDMI Connections

HDMI lets you enjoy high definition digital images and high quality sound by connecting the TV to external devices such as DVD players, set top boxes or gaming equipment.

Power off both the TV and the device before making any connections.

For more information, refer to your device's own instruction book.

When connecting, switch "INPUT" to "HDMI 1/ HDMI 2/ HDMI 3". See, "Selection Source" section.

Note: HDMI cable is not supplied.

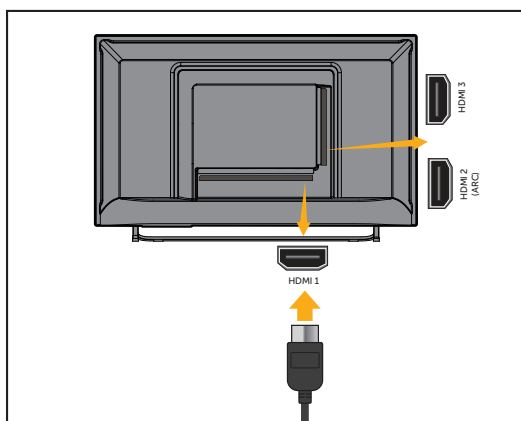

SCART Connections

Most devices support SCART connection. You can connect a DVD recorder, VCR or decoder to the TV using the SCART socket.

Power off both the TV and the device before making any connections.

For more information, refer to your device's own instruction book.

Note: The Scart cable is not supplied.

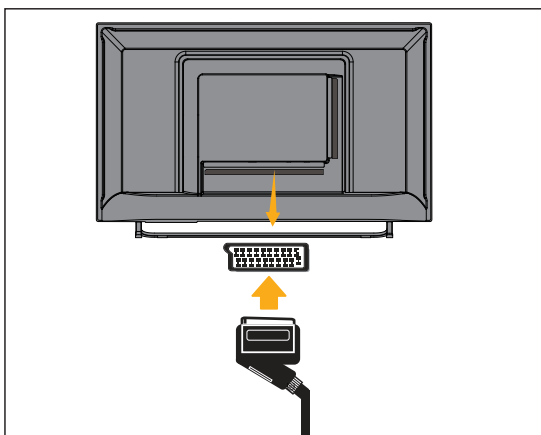

If you require any technical guidance or find that your product is not operating as intended, a simple solution can often be found in the **Troubleshooting** section of these instructions,



Standard features

4



Standard features

Simple everyday use

How to navigate menus - Selecting source

1. Press the **INPUT** button on the bottom of the TV or the **INPUT** button on the remote control to display the Input source list.
2. Press the **▲▼◀▶** buttons to select the input source that you want: Digital / Analogue / SCART / YPbPr / HDMI 1 / HDMI 2 / HDMI 3 / AV.
3. Press **OK** button to confirm your selection.

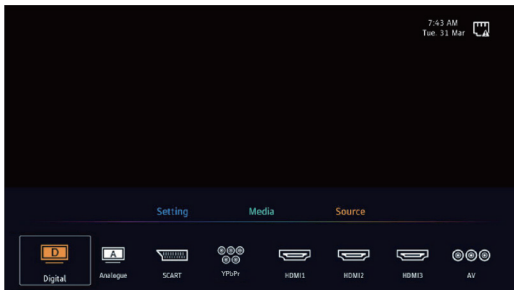

Electronic programme guide (EPG) (DTV mode)

This system has an Electronic Programme Guide (EPG) to help you navigate through all the possible viewing options.

The EPG supplies information such as programme listings, start and end times for all available services. In addition, detailed information about the programme is often available in the EPG (the availability and amount of programme information will vary, depending on the particular broadcaster).

This function can be used only when the EPG information is broadcast by broadcasting companies.

The EPG displays the programme details for the next 7 days.

1. Press the **EPG** button to switch on EPG.

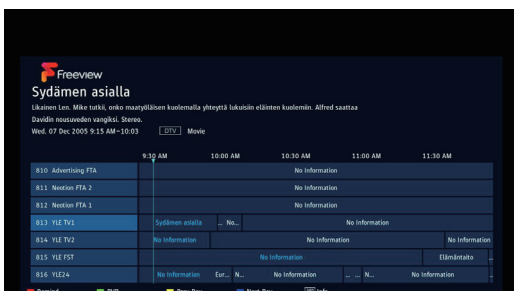

2. Press **EPG** button or **EXIT** button again to switch off EPG and return to normal TV viewing.



Info bar commands:

RED (Remind)

Press the **RED** button while on the selected programme, the Remind setting menu will be displayed. You can view and set the reminder time and frequency.

GREEN (PVR)

Press the **GREEN** button while on the selected programme, the Record setting menu will be displayed. You can view and set the recording time and frequency.

Press the **▲▼◀▶** buttons to adjust the settings then select **Save**, and press **OK** button to confirm the settings. Then  /  will be displayed as your reminders shown. The TV will automatically tune to the selected programme when it starts, and it will have a remind of 30s.

YELLOW (Prev. Date)

Press the **YELLOW** button to view the schedule of the previous day.

BLUE (Next Date)

Press the **BLUE** button to view the schedule of the next day.

• REC

Timer Programming.

Note: A USB storage device must be connected to one of the USB inputs to use the PVR or REC functions.

OK

Press to display detailed information of the selected programme (if available).

Standard features

Simple everyday use

Teletext (ATV mode)

Teletext is a free service broadcast by some TV stations which gives up-to-the-minute information on news, weather, television programmes, share prices and many other topics. Using the Teletext control buttons you can view pages of information that are listed in the teletext **INDEX**.

To Turn on Teletext Function



Make sure the TV channel you are watching transmits teletext.
"No Teletext" sign will show on the screen if teletext is not available.

In ATV mode, press the **TEXT** button to enter Teletext mode. Press the **INDEX** button to display the **INDEX** page.
Press the **TEXT** button once to exit and the TV will return to the channel you were watching.

To select a page of text

Find the number of the page in the **INDEX** and enter it using the **0-9** buttons. The number of the page will appear on the top left corner of the screen.
The page counter will search for your page. When it finds it, the page will be displayed. To move to the next page of text, press the **▲** button.
To move to the previous page, press the **▼** button.
To return to the **INDEX** page, enter the **"100"** by using the **0-9** buttons or press the **INDEX** button.

Mix

To view a page of text while watching a TV programme, press the **TEXT** button twice.
The text will be superimposed over the TV programme.
Double height text If you have difficulty reading the text on the TV you can double the height of the text.
Press the **SIZE** button. The top half of the page will be displayed in double height text.
Press the **SIZE** button again. The bottom half of the page will be displayed in double height text.
Press the **SIZE** button again to return to the full page.

Page HOLD

If the page of text you have selected contains subpages, these subpages will automatically be displayed in order with a delay to allow you to have enough time to read the page.

To stop the movie to the next sub page, press the **HOLD** button.

To continue moving through the sub pages, press the **HOLD** button again.

Alternative: Press the **SUBPAGE** button, and then use the **0-9** buttons to enter a 4-digit page number.

To Reveal Information

Press the **REVEAL** button to reveal concealed information (quiz answers etc.).

Press the **REVEAL** button again to conceal the information again.

Fasttext

At the bottom of the teletext screen is a row of subject headings in red, green, yellow and blue.

The remote control has a row of colour buttons corresponding to the row of coloured subjects on the screen.

Pressing one of the colour buttons will take you directly to the page corresponding to the subject heading.

Standard features

Simple everyday use

Digital Teletext (DTV mode)

Digital teletext can access special digital teletext services and specific services which broadcast digital teletext. You will need to turn off Subtitle Function before using teletext.

1. In DTV mode, press the **TEXT** button to display the teletext page.

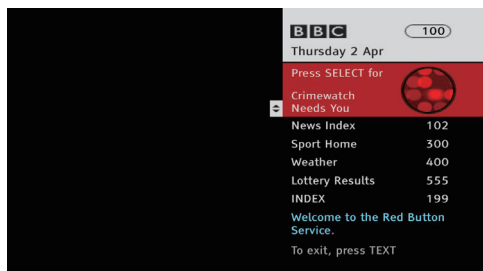

2. Press the **0-9** buttons to select a page number.

3. Follow the instructions on digital teletext and move onto the next step by pressing **OK, ▲▼◀▶, RED, GREEN, YELLOW, BLUE** or **0-9** buttons etc.

4. To change digital teletext service, select a different service by pressing the **0-9** buttons or the **▲▼** buttons.

5. Press the **TEXT** button to exit

Recording DTV Programme onto a USB Storage Device

Use this function to record the DTV programme you are watching on the main screen and save it for future viewing. The recording from timer programme or direct recording may have a little bit of delay when it starts to record the broadcast programme.

Please make sure the USB device is inserted. If not, a warning message will pop up.

1. Press the **● REC** button to record the programme that you are currently watching.



To display the recording information, press the **● REC** button.

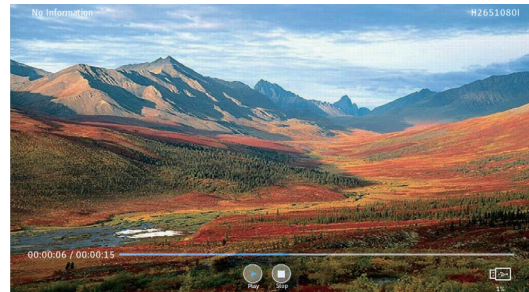

2. Press the **Stop** button to stop recording.



- If a hard disk is used, make sure its mains adapter is connected to the mains supply.
- If a USB hub is used, make sure its mains adapter is connected to the mains supply as the total current consumption may exceed 500mA.
- The maximum supported storage space of the hard disk is 1 TB.
- The file system only supports FAT32 format.
- If you want to store the video streaming of a DTV programme, the transfer rate of the USB storage device must not be less than 5MB/s, otherwise the picture and sound of the programme will be affected and a warning statement will be shown on the screen. If this happens, please upgrade your USB storage device.
- The TV screen will be blank temporarily as it will take time to start up and stabilise the connected hard disk. This is normal and the starting time may vary depending on the brand and the memory size of the connected hard disk.
- Disconnect the USB storage device if it is not in use.

Standard features

Simple everyday use

Timer Programming

This function is used for scheduled recording. The recording from timer programme or direct recording may have a little bit of delay when it starts to record the broadcast programme.

Please make sure the USB device is inserted. If not, a warning message will pop up.

1. Press the **EPG** button on the remote control. The **EPG** menu will appear.

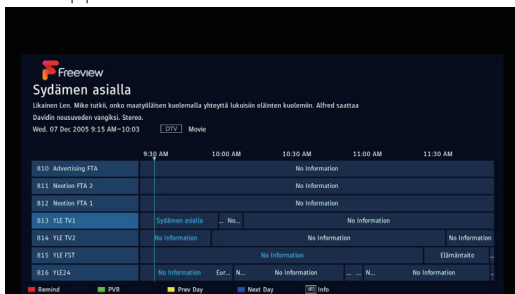

2. Press the **REC** button on the remote control while on the selected programme, the **PVR** menu will be displayed. Press the **▲▼◀▶** buttons to select the settings in the **Record** menu for the Repeat, Record time.

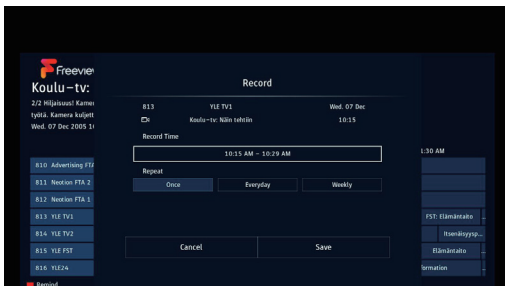

Repeat

Press the **◀▶** buttons to select the Repeat (Once / Every day / Weekly).

Record time

Press the **▲▼◀▶** buttons to adjust the start time and the end time

3. After finishing all the recorder adjustments, press the **Save** button to confirm your settings.

4. The Record Setting List will then be displayed with your preset reminders shown.

5. Press the **EXIT** button to exit EPG.



- When the preset time is reached, the TV will start recording automatically.
- If a programme recording starts when the TV is in standby mode, the LED indicator will alternatively flash red and blue.

Standard features

Simple everyday use

Play Recorded Programme

You can play a recorded programme from the recorded programme list or from a USB Storage Device.

1. Press the **INPUT** button on the bottom of the **TV** or the **INPUT** button on the remote control then press the ◀▶▲▼ buttons to select the Media mode and then press the **OK** button to select your storage device and then press the **OK** button.

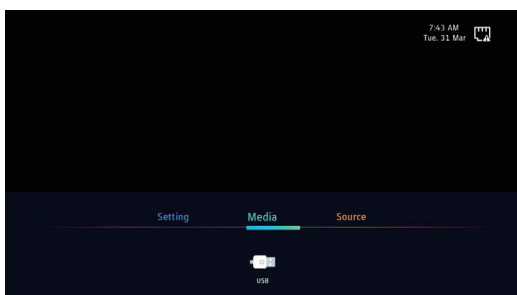

2. Press the ◀▶▲▼ buttons to select **Movies** and then press the **OK** button.

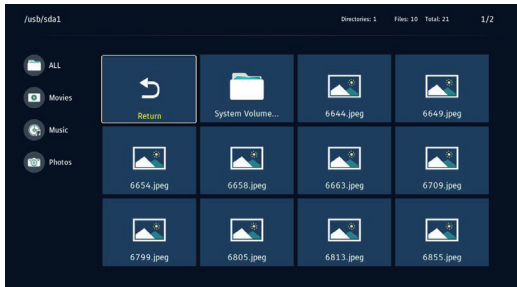

3. Press the ◀▶▲▼ buttons to select your recorded programme and then press the **OK** button to view.

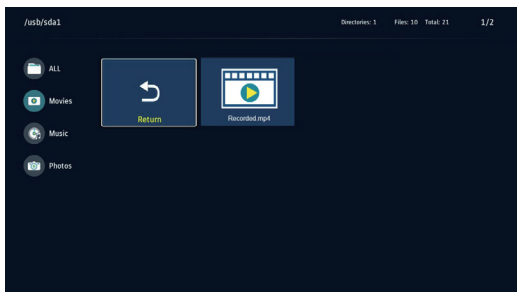

4. Press the **OK** button or the **INFO** button to display the function bar. Press the ◀▶ buttons and then press the **OK** button to select the function: Previous / FB / Pause(Play) / FF / Next / Repeat / Playlist / Info / Zoom.

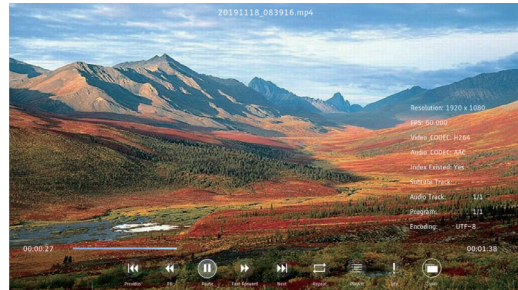

5. Press the **EXIT** button to return to the previous menu.

Quick Settings management (ATV / DTV Mode)

1. Press the **MENU** button to display the main menu. Press the **OK** buttons to select Quick Settings in the main menu, it will highlight the first option.
2. Press the ▲▼◀▶ buttons to change the following settings.

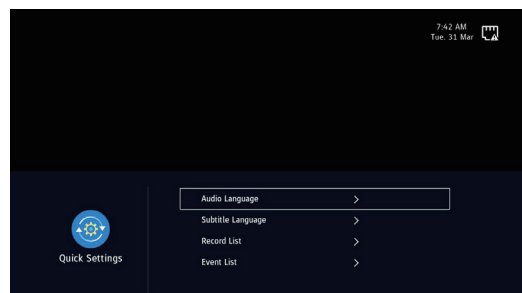

Audio Language (DVT mode)

Press the ▲▼ buttons to select your desired Audio language. Press the ◀▶ buttons to select L/R.

Audio Language (AVT mode)

Language selection for dual language broadcast. If a programme can be received in two languages (dual language), you can switch to DUAL I, DUAL II or Mono by pressing the **AUDIO** button repeatedly. When a programme is selected, press the **AUDIO** button to select Stereo, Dual I, Dual II and Mono.

Subtitle Language

Press the ▲▼ buttons to select your desired subtitle language.

Record List

Select Record List to check the information of the connected USB storage device for PVR.

Standard features

Simple everyday use

Event List

Select Event list to view the scheduled recordings list.

3. Press the **EXIT** button to exit the menu.

Picture management (ATV / DTV Mode)

1. Press the **MENU** button to display the main menu. Press the **◀▶** buttons to select Picture in the main menu, then press the **OK** button, it will highlight the first option.

2. Press the **▲▼◀▶** buttons to change the following settings.

TIPS:

- You can change the value of brightness, contrast, colour, tint, sharpness and backlight when the picture is in Personal mode.
- You can press **P.MODE** button on the remote control to change the Picture Mode directly.

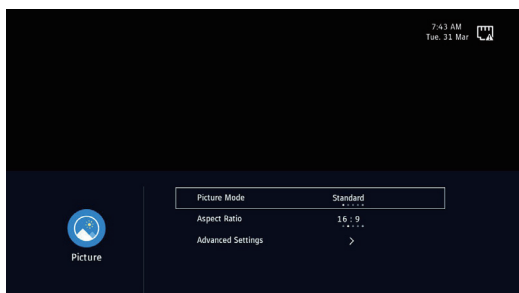

Picture Mode

Allows the selection of a picture-enhancement technical from among the following options: Standard / Personal / Dynamic / Movie / Economy .

Brightness

This item can adjust the brightness output of the entire picture; it will affect the dark region of the picture.

Contrast

This item can adjust the highlight intensity of the picture, but the shadow of the picture is invariable.

Colour

This item can adjust the saturation of the colour based on your own preference.

Tint

This item may use in compensating colour changed with the transmission in the NTSC mode. Not available for PAL transmission.

Sharpness

This item can adjust the peaking in the detail of the picture.

Backlight

This item can adjust the backlight of the colour based on your own preference.

Aspect Ratio

Allows you to watch the screen in various picture formats: Auto / 16:9 / 4:3 / Zoom1 / Zoom2.

Advanced Settings

- **OverScan:** The screen is fully displayed when OverScan off. Part of the screen will not show when OverScan on. Press the **◀▶** buttons to select On or Off.
- **Colour Temperature:** Reduces the colour temperature of the connected device (Standard / Cold / Warm).
- **Dynamic Contrast:** Adjusts the dynamic contrast (Off / Low / High).
- **Noise Reduction:** Reduces the noise level of the connected device (Off / Low / Medium / High).

3. Press the **EXIT** button to exit the menu.

Sound management

1. Press the **MENU** button to display the main menu. Press the **◀▶** buttons to select Sound in the main menu, then press the **OK** button, it will highlight the first option.

2. Press the **▲▼◀▶** buttons to change the following settings.

TIPS:

- You can press the **S.MODE** button on the remote control to change the Sound Mode directly.

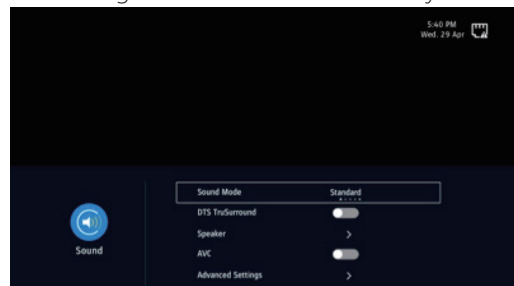

Sound Mode

Allows the selection of an audio-enhancement technical from among the following options: Standard, Music, Sports, Movie and Personal.

DTS TruSurround

This creates a surround sound effect to your TV when switched on and DTS TruSurround is off. Press the **◀▶** buttons to select On or Off.

Standard features

Simple everyday use

Speaker

- **Audio Out** : Press the ◀ ▶ buttons to select PCM, RAW or Off.
- **Digital Audio Delay**: Press the ◀ ▶ buttons to set value of your preference.

AVC

Automatic volume control. Press the ◀ ▶ buttons to select On or Off.

Advanced Settings

- **Balance**: Adjusts the relative volume of the speakers in a multiple speaker system. Press the ◀ ▶ buttons to set value based on your own preference.
- **Treble**: Controls the relative intensity of higher-pitched sounds. Press the ◀ ▶ buttons to set value based on your own preference.
- **Bass**: Controls the relative intensity of lower-pitched sounds. Press the ◀ ▶ buttons to set value based on your own preference.
- **Audio Description**: This is an additional narrative track, mainly used by visually blind and visually impaired users. Selects to turn On/Off Audio Description. (DTV mode)

3. Press the **EXIT** button to exit the menu.

Channel management (ATV / DTV Mode)

1. Press the **MENU** button to display the main menu. Press the ◀ ▶ buttons to select **Channel** in the main menu, then press the **OK** button, it will highlight the first option.

2. Press the ▲▼◀▶ buttons to change the following settings.

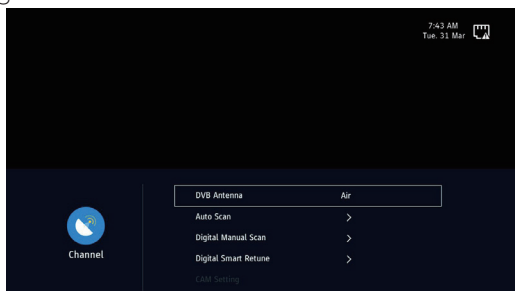

Auto Scan

Use this to automatically find and store all available channels. This is normally recommended if some channels have been added or removed by the broadcaster or you have moved house.

- **Tuning Mode**: Selects the auto scan mode:

Digital+Analogue / Digital / Analogue.

- **Auto Tuning**: Press the ▶ or **OK** button to start auto tuning.

Digital Manual Scan (DTV Mode)

- Press the ◀ ▶ buttons to select the desired channel.
- **Start Scan**: Press the ▲▼ buttons to select Start Scan and then press the **OK** button to start tuning.



If you stop the tuning before it has finished, the TV will report a no signal error. This is normal because all previous channel memory has been cleared before tuning is carried out.

Digital Smart Retune (DTV Mode)

To ensure receiver maintains target region selection, favourites, reminders and scheduled recordings following a rescan.

Press the ▶ / **OK** buttons to select the feature.

CAM Setting (DTV mode)

1. Press the **MENU** button to display the main menu. Press the ◀ ▶ buttons to select **Channel** in the main menu, then press the **OK** button.

2. Press the ▲▼ buttons to select **CAM Setting** and then press the **OK** button.

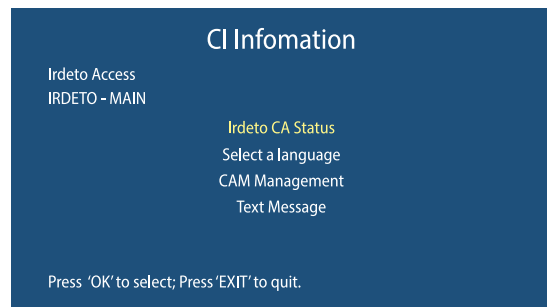

3. A Common Interface main menu will pop up. Press the ▲▼ buttons to select the items and press the **OK** button to confirm.

4. Press the **EXIT** button to exit the menu.

The common interface allows the use of a Common Access Module to enable you to view scrambled (pay to view) services. These services are provided by TopUp TV (UK only) and others. The Common Access Module and viewing card can be obtained from the service provider.



Do not repeatedly insert or remove the Common Access Module as this may damage the interface and cause a malfunction.

This feature is not available in all countries.

Standard features

Simple everyday use

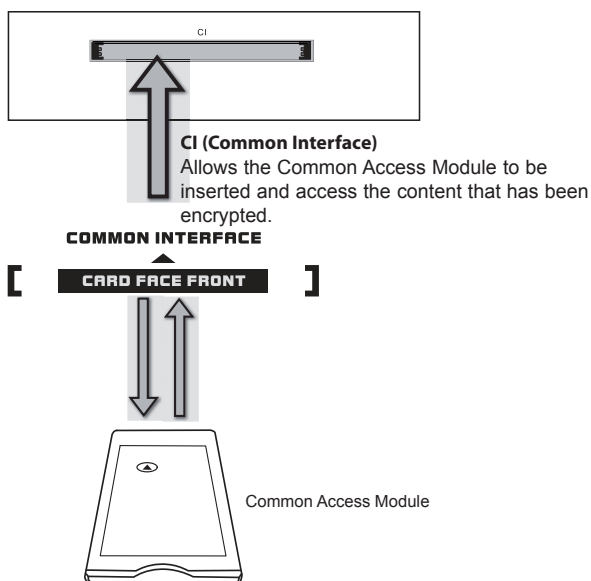

To insert the Common Access Module

1. Before you insert the Common Access Module, ensure that the TV is switched off and the viewing card is inserted **in accordance with the Service Provider's instructions**.
2. Insert the Common Access Module into the slot. Flip the Common Access Module to another side and try again if you feel resistance.
3. Switch the TV on.

To remove the Common Access Module

1. Before you remove the Common Access Module, ensure that the TV is switched off.
2. Pull the Common Access Module from the slot.
3. Switch the TV on.

Signal Information (DTV mode)

1. Press the **MENU** button to display the main menu. Press the ◀▶ buttons to select **Channel** in the main menu, then press the **OK** button.
2. Press the ▲▼ buttons to select **Signal Information** and then press the **OK** button to view the Signal Information.

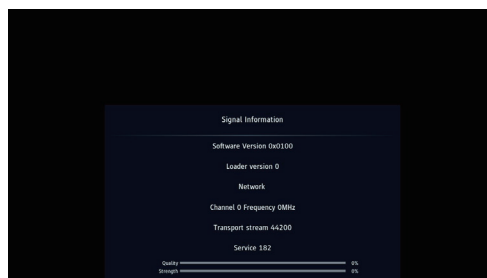

3. Press the **EXIT** button to exit the menu.

Network management

1. Press the **MENU** button to display the main menu. Press the ◀▶ buttons to select **Network** in the main menu, then press the **OK** button, it will highlight the first option.
2. Press the ▲▼◀▶ buttons to change the following settings.

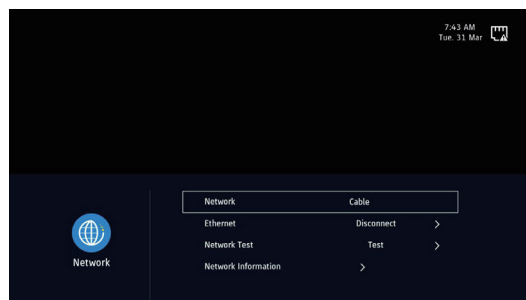

Ethernet

Press the ◀▶ or **OK** button to select DHCP On or Off.

Network Test

Press the ▶ or **OK** button to start the test.

Network Information

Press the ▶ or **OK** button to see network information.

3. Press the **EXIT** button to exit the menu.

Time management

1. Press the **MENU** button to display the main menu. Press the ◀▶ buttons to select **Time** in the main menu, then press the **OK** button, it will highlight the first option.
2. Press the ▲▼◀▶ buttons to change the following settings.

Standard features

Simple everyday use



Time

The clock is set automatically when receiving a digital signal or you can set it manually.

Press the **▶** or **OK** button to select Auto Sync On or Off.

On: Press the **▶** or **OK** button to set Time zone

Off: Press the **▶** or **OK** button to set Date&Time.

On Time

Press the **▶** or **OK** button to enter On Time menu.

On Time: Set the On Time, Input Source, Digital Channel Type(DVT mode), Channel, Volume.

Off Time: Set the Off Time.

Sleep Timer

Press the **▲▼** buttons to select a period of time after which the TV automatically switches to standby mode:

Off/10/20/30/ 60/ 90/120min.

OSD Timer

Displays time of the on-screen menu:

Never/5/10/15/20/30/60/180s.

Auto Standby

The unit will automatically switch to standby mode Off/3/4/5 hours after the last time the remote control was used. If you want to operate the TV for a long period of time, turn off the auto standby function.

3. Press the **EXIT** button to exit the menu.

System management

1. Press the **MENU** button to display the main menu. Press the **◀▶** buttons to select System in the main menu, then press the **OK** button, it will highlight the first option.

2. Press the **▲▼◀▶** buttons to change the following settings.

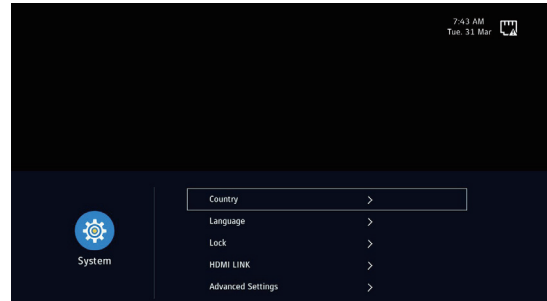

Country

Selects the country where you will operate the TV. The default country is set as UK.

Language

Selects your desired language to be displayed on the menu. The default on-screen menu language is set as English.

- Menu Language
- Primary Audio Language
- Secondary Audio Language
- Primary Subtitle Language
- Secondary Subtitle Language

Lock

Use the **0-9** buttons to input a 4-digit password to enter the Lock System menu.



Default password "0000".

If you change the password, be sure to remember the new password! If you forget the new password, press the master password "4711".

The Lock must be set to On for this function to operate. If the Lock System is set to On, a valid password must be entered when you access Auto Scan / Digital manual Scan.

• Set Password

Use the 0-9 buttons to input the old password and then input the new 4-digit password. Re-enter new password for confirmation.

• Channel Lock

Channel Lock is designed to prevent children watching unsuitable programmes. When a channel is blocked, a valid password must be entered.

• Parental Guidance

This function allows you to set up blocking schemes to block specific channels and ratings. Press the buttons to select an age rating: Off, 4-18.

HDMI LINK

Press the **◀▶** or **OK** button to select On or Off.

When HDMI LINK on, you can set Device Auto Power Off, TV Auto Power on, HDMI ARC, Detect.

Standard features

Simple everyday use

Advanced Settings

Press the ► or OK button to enter Advanced Settings menu. Then press the ▲▼◀▶ buttons to change the following settings.

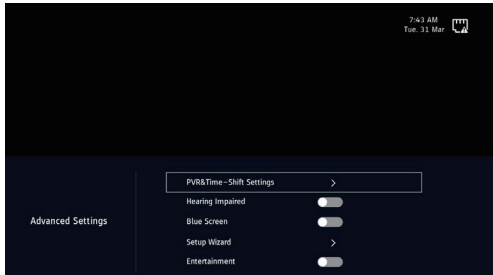

• PVR&Time-Shift Settings

Disk: The path of the current usb flash drive.

Timeshift: Set file size of TimeShift.

Format: Format flash drive.

Speed Check: Check the speed of the usb flash drive.

Hearing Impaired: Auxiliary functions for hearing impairment. Press ◀▶ button to select on or off.

• **Blue Screen:** Blue screen is displayed when there is no signal. Press ◀▶ button select on or off.

• **Setup Wizard:** Select into "First time installation".

• **Entertainment:** Press ◀▶ button to select Store mode on or off.

• **Restore to Default:** Select to restore defaults.

3. Press the EXIT button to exit the menu.

Entertainment

Using the Features via USB Port

1. Switch off the TV before connecting any USB storage device.

2. Connect your USB storage device to the USB port of your TV.

3. Press the button on the bottom of the TV or the button on the remote control to turn on your TV and your USB storage device.

4. Press the INPUT button on the bottom of the TV or the INPUT button on the remote control to display the Source List. Use the ▲▼◀▶ buttons to select MEDIA and then press the OK button to confirm.

Attention:

Some versions of portable hard disk may require more power than the TV USB socket can provide. To ensure correct operation please use power adapter for that device.

• If a USB hub is used make sure its mains adapter is connected to the mains supply as the total current

consumption exceed 500mA.

• The maximum supported storage space of the hard disk is 1 TB.

• The file system only support FAT32 format.

• If you want to store the video streaming of a DTV programme, the transfer rate of the USB storage device must not be less than 5MB/s, otherwise the picture and sound of the programme will be affected and a warning statement will be shown on the screen. If this happens, please upgrade your USB storage device.

• The TV screen will be blank temporarily as it will take time to start up and stabilize the connected hard disk. This is normal and the starting time may vary depending on the brand and the memory size of the connected hard disk.

• Disconnect the USB storage device if it is not in use.

Viewing Photo

1. Press the INPUT button on the bottom of the TV or the INPUT button on the remote control then press the ▲▼◀▶ buttons to MEDIA and then press the OK button.

2. Press the ▲▼◀▶ buttons to select Photos and then press the OK button.

3. Press the▲▼◀▶ buttons to select the picture file and then press the OK button.

4. Press the MENU button to display the function bar: Previous / Rotate+ / Pause(Play)/ Rotate-/ Next / Repeat / Playlist / Info.

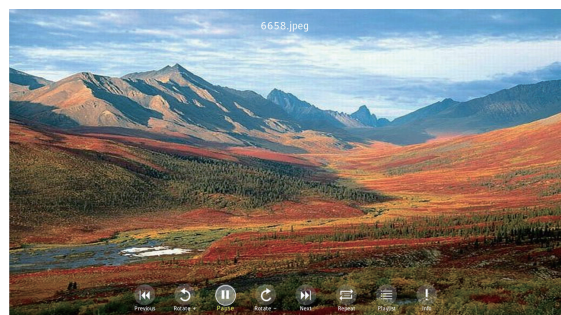

5. Press the EXIT button to return to the previous menu.

Listening to Music

1. Press the INPUT button on the bottom of the TV or the INPUT button on the remote control then press the ▲▼◀▶ buttons to MEDIA and then press the OK button.

2. Press the ▲▼◀▶ buttons to select Music and then press the OK button.

3. Press the▲▼◀▶ buttons to select the music file and then press the OK button.

or online at www.bush-support.com If you still require further assistance, call one of our experts on 0345 604 0105.

Standard features

Simple everyday use

4. Press the **MENU** button to display the function bar:
Repeat / Previous / FB / Pause(Play) / FF / Next / Encoding.

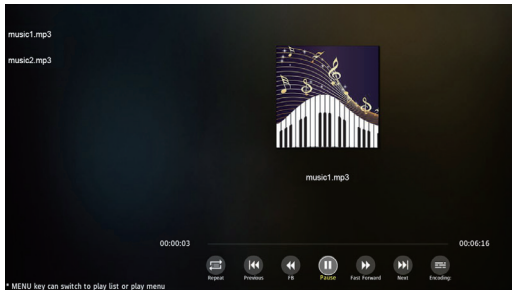

5. Press the **EXIT** button to return to the previous menu.

Viewing Movies

1. Press the **INPUT** button on the bottom of the TV or the **INPUT** button on the remote control then press the **▲▼◀▶** buttons to **MEDIA** and then press the **OK** button.
2. Press the **▲▼◀▶** buttons to select **Movies** and then press the **OK** button.
3. Press the **▲▼◀▶** buttons to select the movie file and then press the **OK** button.
4. Press the **MENU** button to display the function bar:
Previous/FB /Pause(Play) / FF / Next / Repeat / Playlist/
Info/ Zoom.

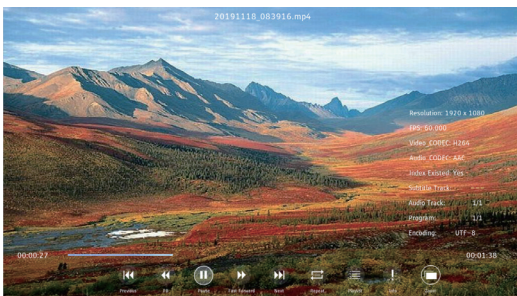

5. Press the **EXIT** button to return to the previous menu.



Other information 5



Other information

Helpful technical information

Specifications

| | |
|--|---|
| TV Broadcasting | PAL, B/G, D/K, I, SECAM, L/L' |
| Receiving Channels | VHF (BAND I/III) - UHF (BAND U) - HYPERBAND |
| Number of Preset Channels | 99 |
| Channel Indicator | On Screen Display |
| RF Aerial Input | 75 Ohm (unbalanced) |
| Operating Voltage | AC 100-240V~ 50/60Hz |
| Audio | Nicam |
| Audio Output Power (WRMS.) (10% THD) | 2 x 6 W |
| Panel Dimensions DxLxH (with stand) | 181.0 x 727.8 x 466.7 mm |
| Weight (with stand) | 4.4 kg |
| Panel Dimensions DxLxH (without stand) | 87.8 x 727.8 x 434.8 mm |
| Energy Consumption Data | EEI A+ |
| On Mode Power Consumption (W) | 65 W |
| Standby Mode (W) | 0.5W |
| Standby Mode | After 4 Hours |
| Operating Temperature | 0°C~40°C |
| Operating Humidity | 10%~80% |

Digital reception

| |
|---|
| MHEG-5 ENGINE compliant with ISO/IEC 13522-5 UK engine Profile 1 - for UK |
| Object carousel support compliant with ISO/IEC 135818-6 and UK DTT profile - for UK |
| Frequency range: 474-850 MHz for UK models |
| 170-862 MHz for EU models |
| Transmission standard: DVB-T/T2 MPEG-2 |
| Demodulation: COFDM with 2K/8K FFT mode |
| FEC: all DVB modes |
| Video: MP@ML, PAL, 4:3/16:9 |
| Audio: MPEG Layer I&II 32/44.148kHz. |

We apologise for any inconvenience caused by any minor inconsistencies in these instructions, which may occur as a result of product improvements and development.

If you require any technical guidance or find that your product is not operating as intended, a simple solution can often be found in the **Troubleshooting** section of these instructions.

Other information

Helpful technical information

Plug replacement - UK and Ireland only

Should you need to replace the plug; the wires in the power cable are coloured in the following way:

Blue – Neutral 'N'

Brown – Live 'L'

As the colours of the wires in the power cable may not correspond with the coloured markings identifying the terminals in your plug, and proceed as follows:

The blue wire must be connected to the terminal that is marked with the letter N.

The brown wire must be connected to the terminal that is marked with the letter L.

If the power lead is damaged, it must be replaced by a qualified electrician.

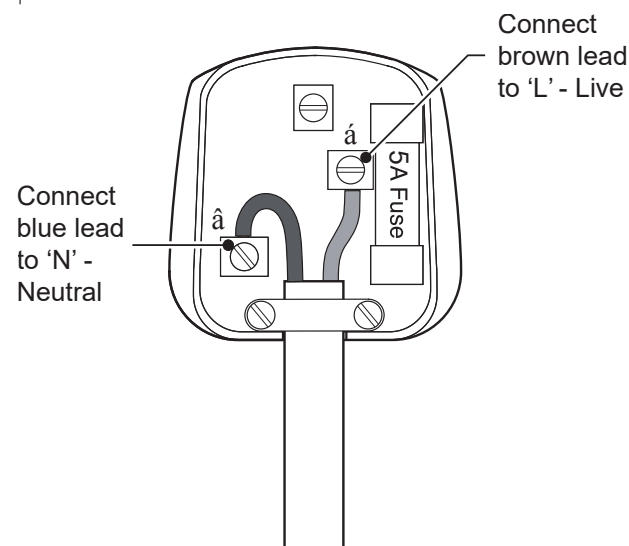

Energy label

This is called the product Fiche – the information needs to be presented in the following order, also this maybe in the form of a copy of the label, in colour or black and white – the label however must display all the information below:

- Supplier's name or trade mark
- Supplier's model product model no.
- The energy efficiency class of the model.
- The visible screen diagonal in centimetres and in inches
- The on-mode power consumption
- The annual energy consumption
- The screen resolution in physical horizontal and vertical pixel count

DTS TruSurround

For DTS patents, see <http://patents.dts.com>.

Manufactured under license from DTS Licensing Limited. DTS, the Symbol, DTS and the Symbol together, and TruSurround are registered trademarks and/or trademarks of DTS, Inc. in the United States and/or other countries. © DTS, Inc. All Rights Reserved.



HDMI

The terms HDMI, HDMI High-Definition Multimedia Interface, and the HDMI Logo are trademarks or registered trademarks of HDMI Licensing Administrator, Inc.



Product support

6



Product support

Help is always at hand

Trouble shooting

Image persistence - ghosting

Please note that ghosting may occur while displaying a persistent image (still or paused image). LCD TVs' image persistence may disappear after a short time. Try turning off the TV for a while. To avoid this, do not leave the screen in still picture mode for extended periods.

No power

If your TV has no power, please check the power cord plug is connected to the mains power socket.

Poor picture

1. Have you selected the correct TV system?
2. Is your TV or house aerial located too close to a non-earthed audio equipment or neon lights, etc.?
3. Mountains or high buildings can cause double pictures or ghost images. Sometimes you can improve the picture quality by changing the direction of the aerial. Is the picture or teletext unrecognisable?
4. Check if you have entered the correct frequency.
5. Please retune the channels.
6. The picture quality may degrade when two devices are connected to the TV at the same time. In such a case, disconnect one of the devices.

No picture

1. No Picture means that your TV is not receiving a transmission. Have you selected the correct button on the remote control? Try once more. Also make sure the correct input source has been selected.
2. Is the aerial connected properly?
3. Are the plugs connected tightly to the aerial socket?
4. Is the aerial cable damaged?
5. Are suitable plugs used to connect the aerial?
6. If you are in doubt, consult your dealer.

No sound

1. Has the TV been set to mute? To cancel mute, press the "M" button, or increase the volume level.
2. Sound is coming from only one speaker. Is the balance set to one extreme?

Remote control - does not operate

Your TV no longer responds to the remote control. The batteries may be exhausted, if so you can still use the control buttons on the bottom of the TV.

Input sources - cannot be selected

1. If you cannot select an input source, it is possible that no device is connected.
2. Check the AV cables and connections if you have tried to connect a device.

Product support

Help is always at hand

Supported file formats

| Media | File Ext. | Codec | | Remark |
|----------------|--------------|--|-------|---|
| | | Video | Audio | |
| MOVIE | .mpg | MPEG-1,MPEG-2 | | Max Resolution: 1920x1080 |
| | | | | Max Data Rate: 40 Mbps |
| | .avi | Xvid,MJPEG | | Max Resolution: 1920x1080 Max Data Rate: 20 Mbps |
| | | MPEG-4 SP/ASP, H.263/H.264 | | |
| | .ts | MPEG-2, H.264, HEVC | | |
| | .mov .mkv | MPEG-4 SP/ASP, H.263/H.264, HEVC | | |
| | .dat | MPEG-1 | | |
| | .mp4 | MPEG-4 SP/ASP, H.263/H.264, HEVC | | |
| MPEG-1,MPEG-27 | | | | |
| .vob | MPEG-2 | | | |
| MUSIC | .mp3 | -- | MP3 | Sample Rate: 8K~48KHz Bit Rate : 32K~ 320Kbps |
| PHOTO | .jpg/P | rogressive JPEG | | Max Resolution: 1024x768 |
| | .jpegB | aseline JPEG | | Max Resolution: 15360x8640 |
| | .bmp | BMP | | Max Resolution: 9600x6400 |
| | | | | Pixel Depth: 1/ 4/8/16/24/32 bpp |
| | .png | Non-Interlaced | | Max Resolution: 9600x6400 |
| Interlaced | | Max Resolution: 1280x800 | | |

Product support

Help is always at hand

Disposal information

Recycling electrical products



You should now recycle your waste electrical goods and in doing so help the environment. This symbol means an electrical product should not be disposed of with normal household waste. Please ensure it is taken to a suitable facility for disposal when finished with. Visit www.recycle-more.co.uk, click on "bank locator" and enter your postcode to find your nearest recycling site.

For more information, please contact the local authority or the dealer where you purchased the product.

Instructions for waste disposal:

Packaging and packaging aids are recyclable and should principally be recycled. Packaging materials, such as plastic bag, must be kept away from children.

The cold cathode fluorescent lamp in LCD PANEL contains a small amount of mercury; please follow the local laws or regulations for disposal.

Notice: The sign Pb below the symbol for batteries indicates that this battery contains lead.



Products



Battery



This product is intended for use within the UK. This equipment complies with the essential requirements of the Radio Equipment Directive RED 2014/53/EC.

Declaration of Conformance

Hereby, Argos Ltd, declares that this television device (catalogue number 484/0754) is in compliance with the essential requirements and other relevant provisions of the Radio Equipment Directive RED 2014/53/EC. The complete declaration of conformity can be obtained by contacting <http://www.bush-support.com>.

Product support

Help is always at hand

Help and assistance

If you require any technical guidance or find that your television is not operating as intended, a simple solution can often be found in the **Troubleshooting** section of these instructions or online at www.bush-support.com

If you still require further assistance, call one of our experts on **0345 604 0105*** . To help give us give you a fast and efficient service please have the following information ready:

| | | |
|------------------|----------------------|---|
| Model Ref. | <input type="text"/> | You can find these on the rating plate - a small information panel (usually a sticker or metal plate) on the rear of your product |
| Serial number | <input type="text"/> | |
| Date of purchase | <input type="text"/> | |

Local call rates applies*

Lines open 8am-7pm Monday to Saturday and 10am-4pm Sunday.

*Calls to Bush enquiry lines may attract a charge and set up fee from residential lines depending on your call plan/tariff. Mobile and other providers costs may vary, see www.bt.com/pricing for details.

For security and training purposes, telephone calls to and from customer service centres may be recorded and monitored. Calls from Republic of Ireland will attract international call charges.

Product support

Help is always at hand

Guarantee

BUSH

Call us now and activate your 12 month guarantee

Thank you for choosing Bush. Your new product is guaranteed against faults and breakdowns for 12 months. Don't forget to register it with us today so we can provide you with our best possible after-sales service and useful updates.

www.bushregistration.co.uk

FREEPHONE*

0800 597 8548

Lines are open 8am - 8pm, 365 days a year. *Calls may be recorded and monitored.

Your Bush Guarantee

This product is guaranteed for twelve months from the date of original purchase. Any defect that arises due to faulty materials or workmanship will be repaired free of charge (or if applicable the product will be replaced or the purchase price refunded) where possible during this period by the dealer from who your purchased the unit.

The guarantee is subject to the following provisions:

- The guarantee does not cover accidental damage, misuse, cabinet parts, knobs or consumable items.
- The product must be correctly installed and operated in accordance with the instructions contained in the manual.
- It must be used solely for domestic purposes. The guarantee will be rendered invalid if the product is re-sold or has been damaged by inexpert repair.
- Specifications are subject to change without notice.
- Bush disclaim any liability for loss or damage arising from the breakdown of the product.
- This guarantee is in addition to and does not diminish your statutory or legal rights.

Important Data Protection Information

To find out how we and Domestic & General Insurance PLC use your data please refer to the guarantee registration material or visit www.bushregistration.co.uk

Guarantor: Argos Limited - 489 - 499 Avebury Blvd. - Milton Keynes - MK9 2NW

If you require any technical guidance or find that your product is not operating as intended, a simple solution can often be found in the **Troubleshooting** section of these instructions,



BUSH

Produced and imported for Argos Ltd
489-499 Avebury Boulevard, Milton Keynes MK9 2NW
Made in China.

Bush is a registered trademark of Argos Ltd.

Contact:

www.bush-support.com

Helpline: 0345 604 0105

HDMI[®]
HIGH-DEFINITION MULTIMEDIA INTERFACE

 **dts**[®]
TruSurround



90101-24991