

THANK YOU FOR BUYING A HOTPOINT PRODUCT.

In order to receive a more complete assistance, please register your product on www.hotpoint.eu/register



Before using the appliance read the Safety Instructions carefully.

CONTROL PANEL

- 1 Programme selection knob
- 2 On/Off button
- 3 Start/Pause button

Options buttons

- 4 Gentle Power
- 5 Crease Care
- 6 Cycle End Signal
- 7 Cycle Options (hold for Settings)
- 8 Dryness Level
- 9 Timed Drying
- 10 Start Delay

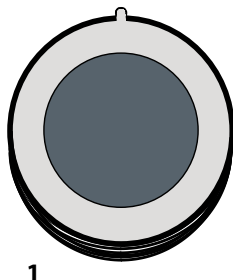

1

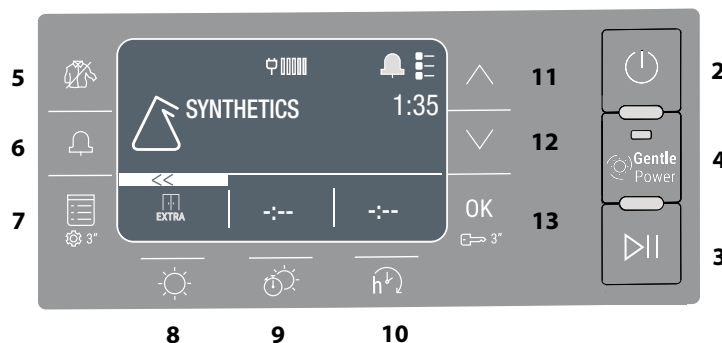

Navigation buttons and Key Lock

- 11 UP
- 12 DOWN
- 13 CONFIRM OK (hold for Key Lock)

INDICATORS

Cycle phase: ☀ Drying - 🌡 Cool Down - END End of Cycle

🚰 Empty water tank - 🧼 Clean secondary filter - 🚫 Clogged door filters - 🧹 Autoclean - 📶 Eco Monitor

Refer to Troubleshooting section: 🗨 Failure call After-sales Service - DEMO Demo Mode

FIRST TIME USE

When starting the appliance the first time, the control panel will automatically show the set language menu. The **UP** and **DOWN** buttons are used to show the languages available in the machine. Press the **OK** button to confirm. The machine cannot be used without having selected the language.

Make sure that the water tank is correctly inserted.

The dryer must be installed in a room with a temperature ranging between 5°C and 35°C to ensure proper operation. Before using the dryer make sure it has been in an upright position for at least 6 hours.

DAILY USE

Doing this will keep your machine working at its BEST:

- remember to empty your water tank after each drying cycle.
- remember to clean your filters after each drying cycle.

Refer to the Care & Maintenance section.

1. Plug the dryer into the power supply socket.
2. Open the door and load garments; always refer to instructions on clothing labels and the max loads indicated in the programme section. Empty pockets. Make sure garments do not get caught between the door and/or the door filter. Do not load items that are dripping wet. Do not tumble dry large, very bulky items.
3. Close the door.
4. Press the "On/Off" button.
5. Select the most suitable programme for the type of fabric in that load.
6. Select the options, if necessary.
7. Press the "Start/Pause" button to begin drying.
8. At the end of the drying cycle, a buzzer will beep. An indicator on the control panel signals the end of the cycle. Pull the load out immediately to prevent the formation of creases on laundry.
9. Turn the machine off by pressing the "On/Off" button, open the door and pull the clothing out. If the machine is not switched off manually, after about a quarter of an hour from the end of the cycle, the appliance turns off automatically to save energy. Note that some programme/option accords with "Crease Care" system. This means that for some hours, after the end of the drying cycle, the drum rotates at regular intervals to prevent the formation of creases. In case of power failure, it is necessary to press the "Start/Pause" button to restart the cycle.

Eco Monitor

This indicator shows the energy consumption level according to the programme and the options set. The consumption is proportional to the lines on the display, by the ecomonitor icon.

OPENING THE DOOR DURING THE CYCLE

Laundry can be checked while the drying cycle runs and any garments already dry can be removed, while drying continues for the remaining items. After closing the door, press the "Start/Pause" button to resume machine operation.

Keep the door closed until the cycle end to save time and energy.

NAVIGATION

The "UP" and "DOWN" buttons are used to navigate the available menus.

- Press the **OK** button to confirm the selection.
- Press the Option button at the << symbol, where present on the display, to return to the previous screen.

If no selection is confirmed, after about 2 minutes, the display return to the main screen.

SETTINGS

To access the Settings menu, press and hold the relevant button for a few seconds.

- **Set language** shows the available languages on the display.
- **Sounds** allows to enable or disable the sounds (some sounds, as warnings, will remain active anyway).
- **Brightness** allows to modify the display brightness.
- **Factory Default** allows to reset the default settings. After having selected the setting, press and hold the **OK** button for a few seconds.

***MAX LOAD 9 Kg (Dry load)**

CARE LABEL





















Always check the care labels, especially when placing garments in the tumble dryer for the first time. Below are the most commonly used symbols:

- ☐ May be tumble dried.
- ☒ Do not tumble dry.
- ☀ Tumble dry – high heat.
- ☁ Tumble dry – low heat.



PROGRAMS

The duration of these programs will depend on the size of the load, types of textiles, the spin speed used in your washer and any extra options selected. **In machines equipped with display, the duration of the cycles is shown on the control panel.** The remaining time is constantly checked and adjusted during the drying cycle to show the best possible estimate.
Option to use - If all your loads on Automatic Cycles are consistently less dry or more dry than you would like, you may increase or decrease the dryness level using the specific option.

-  **Mixed** **kg 4**
This programme is ideal for drying cotton and synthetic fabrics together.
-  **Eco Cotton** **kg Max***
This is the most efficient programme in terms of energy consumption and is suitable for drying normal wet cotton laundry. The values on the Energy Label are based on this programme.
NOTE: for optimal energy efficiency, select "Cupboard Dry" using dryness level option. To increase the dryness level, select "Extra Dry".
-  **Synthetics** **kg 4**
For drying synthetic fabrics.
-  **Daily** **kg 2**
Ideal for drying garments of cotton blends or synthetics spun at high speed in the washing machine.
-  **Wool** **kg 1**
Programme for drying wool clothes. It is advisable to turn the items inside out before drying. If heavy edges remain damp, leave them to dry naturally.
-  **Silk** **kg 0.5**
Gentle drying of silk garments.
-  **Baby** **kg 2**
A programme intended for drying newborns items (cotton and chenille), as well as delicate items. Do not dry items with plastic coverings.
-  **Duvet**
Programme intended to dry bulky items, such as a single duvet.
-  **More Cycles**
-  **Bed & Bath** **kg Max***
This programme is intended for drying cotton towels and sheets.
 -  **Microfiber** **kg 2**
Gentle drying for microfiber.
 -  **Cuddly Toys**
This cycle preserves the appearance of cuddly toys, keeping them at their best. Remove all accessories before proceeding with drying. Each single piece must not exceed 600 gr.
 -  **Fitness** **kg 4**
For drying sports garments made of synthetics or cotton.
 -  **Down Jacket** **kg 2**
To dry down jackets, restoring their natural softness (2 jackets).
 -  **Mats** **kg 3**
To dry small bath or kitchen mats. Do not dry mats with plastic parts, as this could cause a fire hazard.
 -  **Lingerie** **kg 2**
To dry very delicate underwear. Close all hooks before drying.
 -  **Shirts** **kg 3**
This is a programme for cotton or cotton blend/synthetics shirts.
 -  **Jeans** **kg 3**
For drying sturdy cotton including denim trousers and jackets.
 -  **Anti Allergy** **kg Max***
This cycle has the "Allergy UK" approval of "The British Allergy Foundation" attesting the effective reduction and elimination of allergens. It can be used both with damp load (drying and treatment) and dry load (half load only).
 -  **Pre- Iron**
This cycle relaxes fibres, thus making ironing and folding easier. Suitable for small load of damp or dry cotton and cotton blend fabrics. Not for wet items.





 **Rapid 30'** **kg 0.5**
Ideal for drying cotton garments spun at high speed in the washing machine.

 **Refresh**
A short programme suitable for refreshing fibres and garments through the emission of fresh air. Do not use on wet items. It can be used on with any load size but is more effective with small loads. It lasts about 20 minutes.

OPTIONS

These buttons allow you to personalise the selected programme according to personal requirements.
Not all options are available for all programmes. Some options may be incompatible with ones you have previously set; if so, you will be alerted by the buzzer and/or blinking indicators. If the option is available, the option indicator will stay on. The programme may retain some options selected in previous drying cycles.

 **Dryness Level**
Press the relevant button several times to obtain a different level of residual moisture on your laundry. The display signals the level being selected. After few seconds of inactivity, the display returns to the main menu.

-  **Iron Dry:** very delicate drying. Items will be more easily ironed immediately after the cycle.
-  **Hanger Dry:** a level intended for delicate garments ready to be hanged.
-  **Cupboard Dry:** the laundry is ready to be folded and put away.
-  **Extra Dry:** for laundry intended to be worn at the end of the cycle.

 **Timed Drying**
This option is to manually set the drying time. Press the corresponding button to set the required time for drying. An indicator on the control panel signals the time being selected.

 **Start Delay**
This option is for delaying the start of the cycle. Press the corresponding button several times to find the required delay. Once the max time is reached, the option is reset by pressing the button again. An indicator on the control panel signals the time being selected. After pressing the "Start/Pause" button, the machine signals the time remaining to the start of the cycle. If the door is opened, press the "Start/Pause" button once the door has been closed.

 **Crease Care**
This option add a crease treatment at the end of the cycle by means of a periodic rotation of the drum (duration up to 10 hours). It is particularly suitable when it is not possible to remove the laundry as soon as the drying ends. If this option is used together with the Start Delay, the crease treatment is added also in the Start Delay phase. This option remains in memory if selected in the previous drying.

 **Gentle Power**
At the end of the drying cycle laundry loses the wet film, which protects them from wear and friction. When this option is activated the dryer performs anti-stress drum movements that minimise the effects of fabric wear, meanwhile the air circulation system provides a more even drying. The cycle time will be extended when this option is turned on.

 **Key Lock**
This option makes all machine controls inaccessible, except the "On/Off" button. When the machine is on:

- to activate the option, keep the button pressed until the machine signals that the option has been enabled.
- to disable the option, keep the button pressed until the machine signals that the option has been disabled.

This option remains in memory if selected in previous drying.

 **Cycle End Signal**
This option activates a prolonged buzzer at the end of the cycle. Enable it if you do not think you will hear the normal sound at the end of the cycle. After having pressed the option button, it can be enabled or disabled using the **UP** and **DOWN** buttons.

Press the **OK** button to confirm.

This option remains in memory, if selected in previous drying.

☰ Cycle Option

This button provides access to the menu of options below. Scroll the options with the **"UP"** and **"DOWN"** buttons and press the **OK** button to confirm the selection.

- ☀ **Gentle**
Enables a more gentle treatment of the laundry by reducing the drying temperature.

- 🧺 **Iron Ready**
This option signals when the garments reach a dryness level suitable for ironing by means of the beeps and the display. Remove the garments to be ironed, close the door and press the Start/Pause button. The dryer goes on working until the remaining garments reach the selected dryness level..

CARE AND MAINTENANCE

WARNING: unplug the dryer during the cleaning and maintenance procedures.

🚰 Emptying the water tank after each cycle (see fig. A).

Pull the container out of the dryer and empty it into a sink or other suitable drain, then place it back properly. Do not use the dryer without having inserted the container back in place.

🧼 Cleaning the primary door filter after each cycle (see fig. B).

Pull the primary door filter out and clean it by removing the lint from the filter surface under running water or using a vacuum cleaner.

🧼 Cleaning the secondary door filter when the relevant indicator turns on (see fig. C).

Pull the secondary door filter out and clean it in all its parts by washing it under running water or using a vacuum cleaner.

🧼 Clogged filters - clean both door filters (see fig. B, fig. C).

For optimal performance, dry the filters before inserting them back in place.

Do not use the dryer without having inserted all filters back in place properly first.

The filters are essential parts for drying. They are intended to collect the lint formed during the drying process. In case of clogged filters, the air flow inside the dryer would be seriously affected: the drying time would be longer, the energy consumption would increase and the dryer could be damaged. If these procedures are not carried out properly, the dryer may not start.

☰ Autoclean

The maintenance of the bottom filter of this model is automatic. The dryer carries out cleaning when the sensors signal the need to do so. In this case, the machine goes on working even when the drying cycle is completed. An indicator on the control panel will signal the maintenance. **Do not switch the machine off during this phase.**

PRODUCT DESCRIPTION

1. Water Tank (A)
2. Air Intake grille
3. Door filter: primary (B), secondary (C)

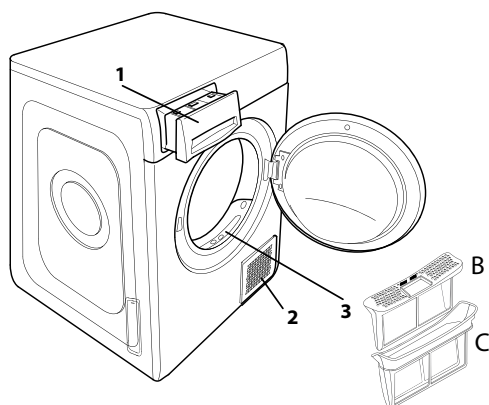

Cleaning the tumble dryer

- The external metal, plastic and rubber parts can be cleaned with a damp cloth.
- Clean the front air intake grille regularly (every 6 months) with a vacuum cleaner to remove any lint, fluff or dust deposits. Furthermore, remove any lint deposits from the filters area, using a vacuum cleaner every so often.
- Do not use solvents or abrasives.

TRANSPORT AND HANDLING

Never lift the dryer by holding on to its top side.

1. Unplug the dryer
2. Remove the water from the water tank completely.
3. Make sure that door and water tank are properly closed.

Power consumption			
off-mode (Po) - Watts			0.50
left-on mode (Pl) - Watts			2.00
Programmes	Kg	kWh	Minutes
Eco Cotton * ☐	9	2.12	250
Eco Cotton ☐	4.5	1.20	160
Synthetics	4	0.63	90

*This is the reference programme for the energy label and suitable to dry normal wet cotton laundry. This is the most efficient programme in terms of energy consumption for drying wet cotton laundry. (Standard/Default starting configuration)

Heat Pump System

The heat pump contains fluorinated greenhouse gases, contained in a hermetically sealed unit. This sealed unit contains 0.18 kg of the F gas R134a. GWP = 1430 (1 t CO₂).

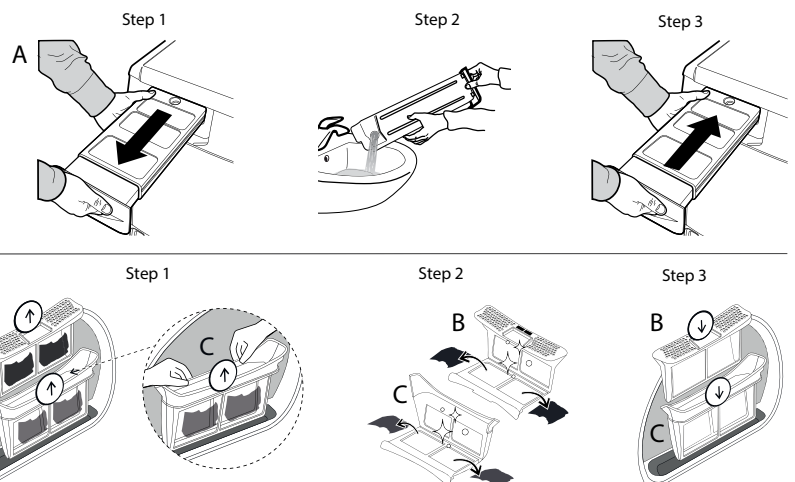

TROUBLESHOOTING

Before contacting the After-sales Service, refer to the table below. Often the malfunctions are minor and can be solved in few minutes.

Malfunction	Possible cause	Solution
The tumble dryer does not turn on.	The plug is not inserted into the socket.	Insert the plug into the socket.
	The plug is faulty.	Try to plug another appliance in the same socket. Do not use connecting electrical devices to the socket, such as adapters or extensions.
	A power failure occurred.	Wait for the power supply to be restored and switch the fuse on again if necessary.
The tumble dryer does not start.	The door has not been closed properly.	Close the door.
	A time delay was set to the start of the cycle.	For machines equipped with this function: wait for the set delay to end or switch the machine off to reset it. Refer to the Options section.
	The "Start/Pause" button was not pressed in order to start the programme.	Press the "Start/Pause" button.
	The Key Lock function was enabled (for machines equipped with this option).	Refer to the Options section. If Key Lock was selected, disable it. Switching the machine off will not disable this option.
Garments are wet at cycle completion.	Small load.	The automatic programme has not sensed the required final moisture so that the dryer completes the programme and stops. If this happens simply select an additional short period of drying or select Extra Dry option if available.
	Large loads or heavier fabrics.	Dryness levels can be modified to the specific dryness desired. Extra Dry is recommended for ready to wear items.
The drying times are very long.	An appropriate maintenance was not carried out.	Refer to the Care & Maintenance section and perform the operations described.
	The programme, the time and/or the drying level set are not suitable for the type and the amount of load inserted into the dryer.	Refer to Programmes and Options sections to find the programme and options most suitable for the type of load..
	The garments are too wet.	Carry out a washing cycle with higher spin speed to remove as much water as possible.
	The dryer may be overloaded.	Refer to the Programmes section to check the max load for each programme.
	Room temperature.	The drying time may be longer if the room temperature falls outside the 14–30°C range.
The programme did not end.	A power failure occurred might have occurred.	In case of power failure, it is necessary to press the "Start/Pause" button to restart the cycle
Lights on or flashing		
Water tank	The water tank is full.	Empty the water tank. Refer to the Care & Maintenance section
Door filter	Failure of the air flow necessary for machine operation.	Clean the door filter and check whether air intake is free. Carrying out these operations improperly may cause damages. Refer to Care & Maintenance section.
Bottom filter*	The bottom filter requires cleaning.	Clean the bottom filter. Refer to Care & Maintenance section.
DEMO The cycle lasts few minutes.	The dryer is in DEMO mode. The DEMO indicator is on.	Disable the DEMO mode. The following actions must be carried out in sequence, without breaks. Switch the machine on and then switch it off again. Press the "Start/Pause" button until the buzzer is heard. Switch the machine on again. The machine signals that the function was disabled.
The presence of wrench symbol signals a malfunction.	The machine sensors detected a failure.	Switch the dryer off and unplug it. Open the door immediately and pull laundry out, to allow the heat to dissipate. Wait for about 15 minutes. Reconnect the dryer to the power supply, load the laundry and restart the drying cycle. If the problem still occurs, contact the After-Sales Service Centre and communicate the letters and digits flashing on the display. For instance: F3 and E2.

*Note: some models are auto-cleaning and not equipped with bottom filter. Please refer to the Care & Maintenance section.



You can download the Safety Instructions, User Manual, Product Fiche and Energy data by:

- Visiting our website - docs.hotpoint.eu
- Using QR Code
- Alternatively, **contact our After-sales Service** (See phone number in the warranty booklet). When contacting our After-sales Service, please state the codes provided on your product's identification plate.

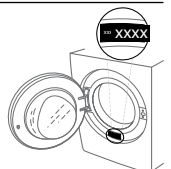

Hotpoint



W11555215

07/2021