

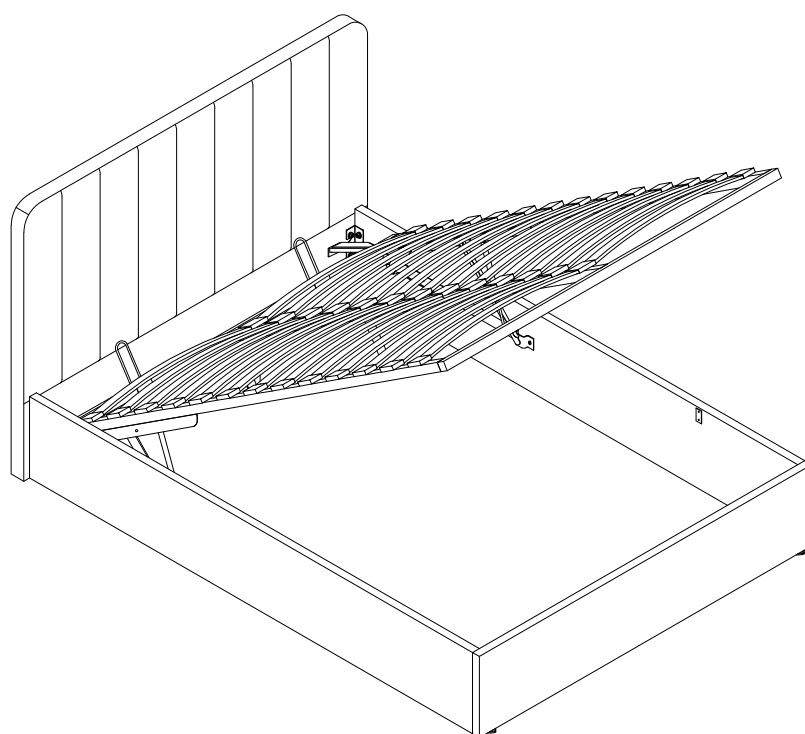

# Pandora



## Spare Parts

 [www.argos-support.co.uk](http://www.argos-support.co.uk)

 [Help@ClickSpares.co.uk](mailto:Help@ClickSpares.co.uk)

 0370 112 1928

## Customer Support

 0345 640 2020

 [argos.co.uk/help/contact-us](http://argos.co.uk/help/contact-us)



# Safety and Care Advice

## Product Details

4' Bed Silver Grey 500/5598	4'6 Bed Silver Grey 306/4177	5' Bed Silver Grey 955/4612	6' Bed Silver Grey 776/0439
4' Bed Blush Pink 310/1308	4'6 Bed Blush Pink 337/7785	5' Bed Cream 761/7173	6' Bed Cream 776/3742
4' Bed Navy 474/8337	4'6 Bed Navy 344/4780	5' Bed Navy 466/9320	6' Bed Taupe 762/3387
4' Bed Cream 393/2278	4'6 Bed Cream 329/9825	5' Bed Forest Green 449/9545	
4' Bed Forest Green 474/5732	4'6 Bed Forest Green 407/0122	5' Bed Taupe 761/8220	
4' Bed Taupe 733/3093	4'6 Bed Taupe 765/6749	5' Bed Blue Black 775/1589	
4' Bed Blue Black 774/7232	4'6 Bed Blue Black 779/1587	5' Bed White Boucle 773/6951	
4' Bed White Boucle 775/7796	4'6 Bed White Boucle 776/8008		

## IMPORTANT, RETAIN FOR FUTURE REFERENCE: READ CAREFULLY.

- Keep children and animals away from the work area, small parts could choke if swallowed.
- Make sure you have enough space to layout the parts before starting.
- This product has been constructed to be used in the domestic environment only and not for commercial purposes.

- Assemble the item as close to its final position (in the same room) as possible.
- Assemble on a soft level surface to avoid damaging the unit or your floor.

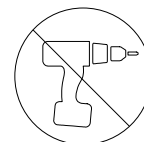

• We do not recommend the use of power drill/drivers for inserting screws as this could damage the unit. Only use hand screwdrivers.

- Parts of the assembly will be easier with 2 people.
- Dispose of all packaging carefully and responsibly.

## Cleaning Guidance

- Minor stains and spillages should be removed immediately from cushion fabric, by wiping over lightly with a damp cloth and mild soapy water.
- Light marking can also be removed using this method.
- To remove more stubborn stains or marking, a good quality proprietary domestic fabric cleaner can be used, although it should first be tested on an inconspicuous area of the fabric.

## Important Ottoman Safety Warnings

- Caution. This bed uses a pressurised mechanism.
- Use caution when operating - Always use two hands at arm's length, and only where illustrated on the product.
- You must ensure the mattress is on the frame before lifting the mechanism - Failure to do so may result in injury.
- Please ensure Children and pets are kept away from the bed when operating the bed mechanism.
- If removing the mattress, make sure that the frame is secured as it could flip open.
- Only use the storage compartment when the frame is fully raised in the 'up' position.
- No children or animals are left unattended when the frame is in the 'up' position.
- Do not remain on the bed whilst the lifting mechanism is in use.
- Beware of Entrapment - Keep both hands clear of mechanism when operating the mechanism.
- When lifting the bed remove all bedding - Except the fitted sheet.
- Only suitable for persons aged 13 years +.

## Information For Use

	Small Double Size 4'0	Double Size 4'6	King Size 5'0
Mattress Size	1200x1900mm	1350x1900mm	1500x2000mm
Maximum Mattress Weight	45KG	45KG	45KG

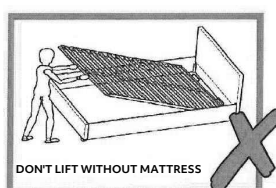
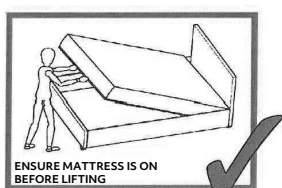

# Fittings (Shown to scale)

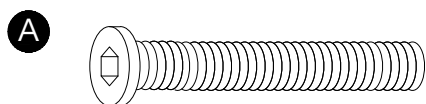

8x45mm Bolt x 6

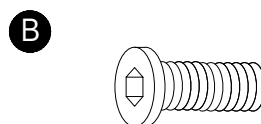

8x25mm Bolt x 50

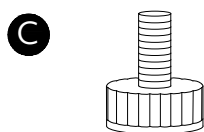

8mm Bolt x 4

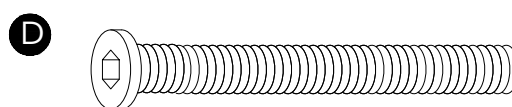

8x60mm Bolt x 2

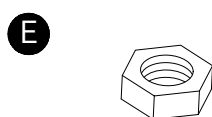

Nut x 6



17mm Flat washer x 58



12mm Spring washer x 34

**Note: All fittings packed inside the back of the headboard**

# Parts

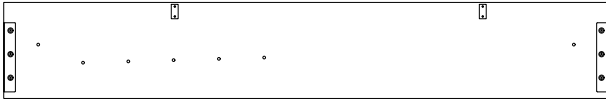

- 1 Right side rail x 1  
(4'-4'6"-1930 x 305mm)(5'/6'-2030 x 305mm)



- 2 Left side rail x 1  
(4'-4'6"-1930 x 305mm)(5'/6'-2030 x 305mm)



- 4 Footboard x1 (4'-1300 x 305mm)  
(4'6"-1450 x 305mm)(5'-1600 x 305mm)  
(6'-1900 x 305mm)

**Note: Packed inside the back of the headboard**



- 6 Metal corner plate x 4 (169 x 35mm)  
**Note: Packed inside the back of the headboard**

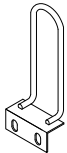

- 8 Mattress support bracket x 2  
**Note: Packed inside the back of the headboard**

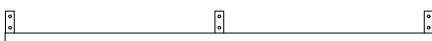

- 10 Ottoman end frame (Footboard) x 1  
(4'-1213 x 85mm)(4'6"-1363 x 85mm)  
(5'-1513 x 85mm)(6'-1813 x 85mm)  
**Note: Packed inside the back of the headboard**

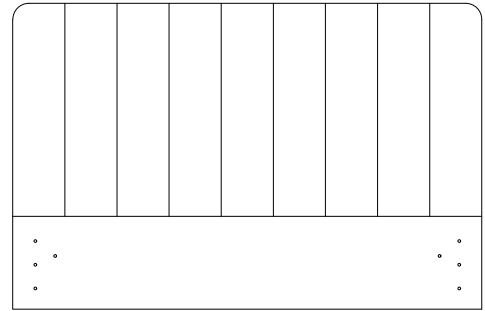

- 3 Headboard x1 (4'-1350 x 980mm)  
(4'6"-1500 x 980mm)(5'-1650 x 980mm)  
(6'-1950 x 980mm)

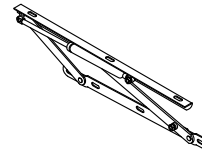

- 5 Hinge Mechanism (x 1 pair)  
NOTE: PISTON ATTACHED

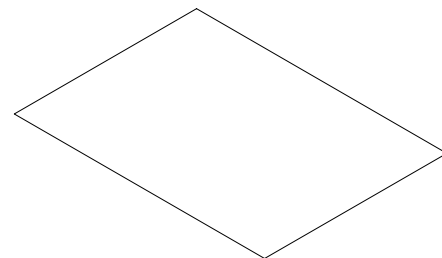

- 7 Fabric base x 1 (4'-1965 x 1280mm)  
(4'6"-1965 x 1430mm)(5'-2065 x 1580mm)  
(6'-2065 x 1880mm)  
**Note: Packed inside the back of the headboard**

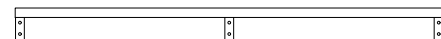

- 9 Ottoman end frame (Headboard) x 1  
(4'-1213 x 85mm)(4'6"-1363 x 85mm)  
(5'-1513 x 85mm)(6'-1813 x 85mm)  
NOTE: EXTRA HOLES  
**Note: Packed inside the back of the headboard**



- 11 Ottoman frame (Sides) x 2  
(4'-4'6"-1822 x 30mm)(5'/6'-1922 x 30mm)

# Parts

---

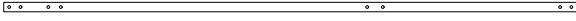

- 12 Ottoman frame centre support x 1  
(4'/4'6"-1822 x 30mm)(5'/6'-1922 x 30mm)

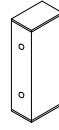

- 13 Ottoman frame support x 1  
(94 x 40mm)

**Note: Packed inside the back of the headboard**



- 14 Bentwood slats x 28 (4'-598 x 9 x 53mm)  
Bentwood slats x 28 (4'6"-675 x 9 x 53mm)  
Bentwood slats x 30 (5'-750 x 9 x 53mm)  
Bentwood slats x 30 (6'-903 x 9 x 53mm)

**Note: Packed inside the back of the headboard**

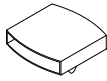

- 16 Double slat caps x 14 (4'/4'6"-55mm)  
Double slat caps x 15 (5'/6'-55mm)

**Note: Packed inside the back of the headboard**



- 15 Single slat caps x 28 (4'/4'6"-55mm)  
Single slat caps x 30 (5'/6'-55mm)

**Note: Packed inside the back of the headboard**

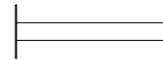

- 17 Support Leg x 2 (25 x 205mm)

**Note: Packed inside the back of the headboard**

# Tools required

---

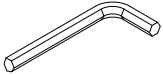

Allen key (Supplied)

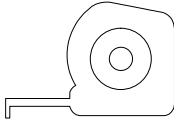

Ruler/tape measure

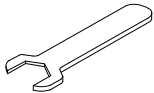

Spanner (Supplied)

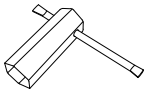

Box spanner (Supplied)

# 1

Components packed inside back of headboard

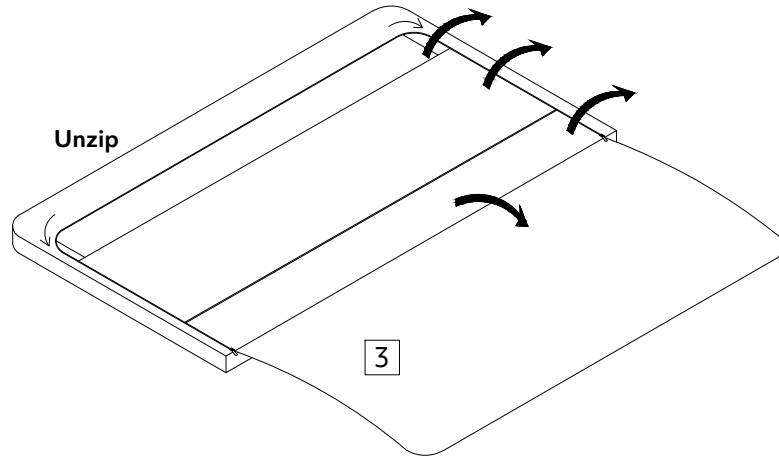

**WARNING!**  
The headboard is heavy.  
Lift with care.

Shown upside down

# 2

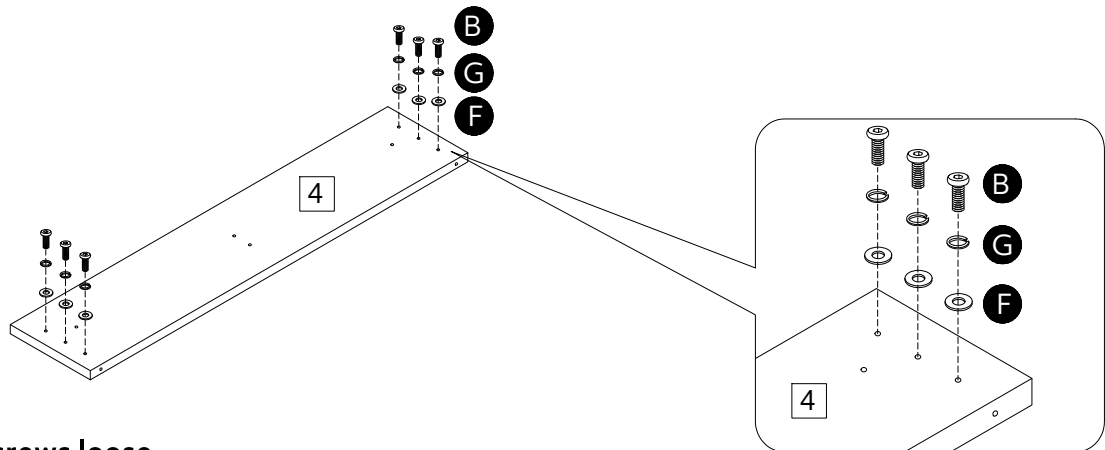
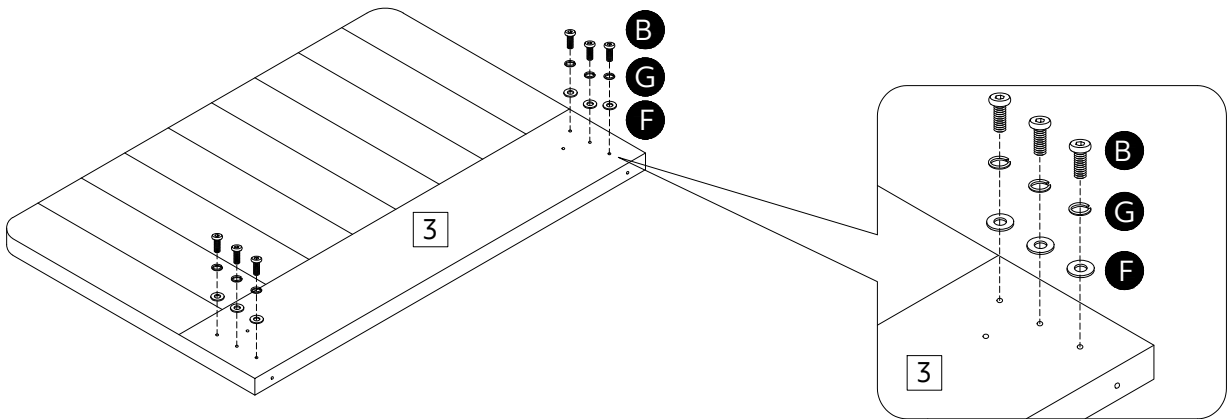
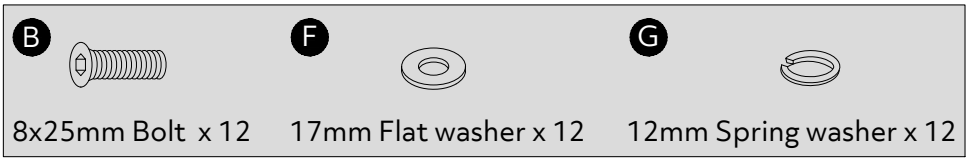
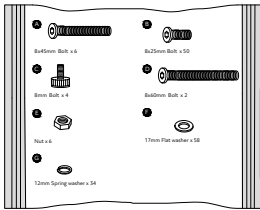

Leave screws loose

# 3

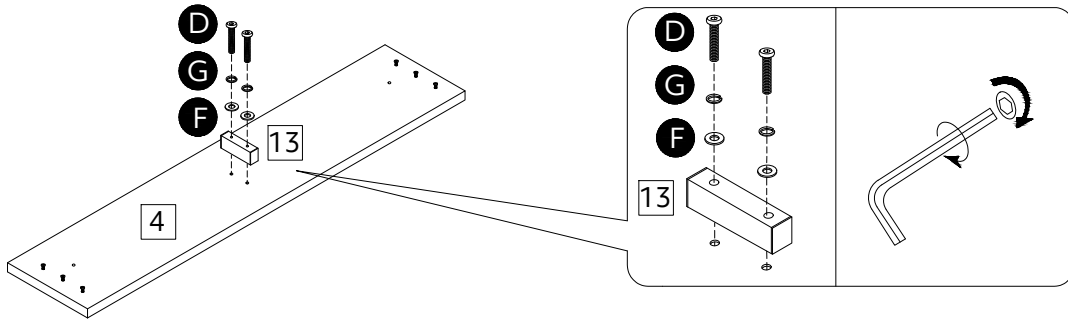

# 4

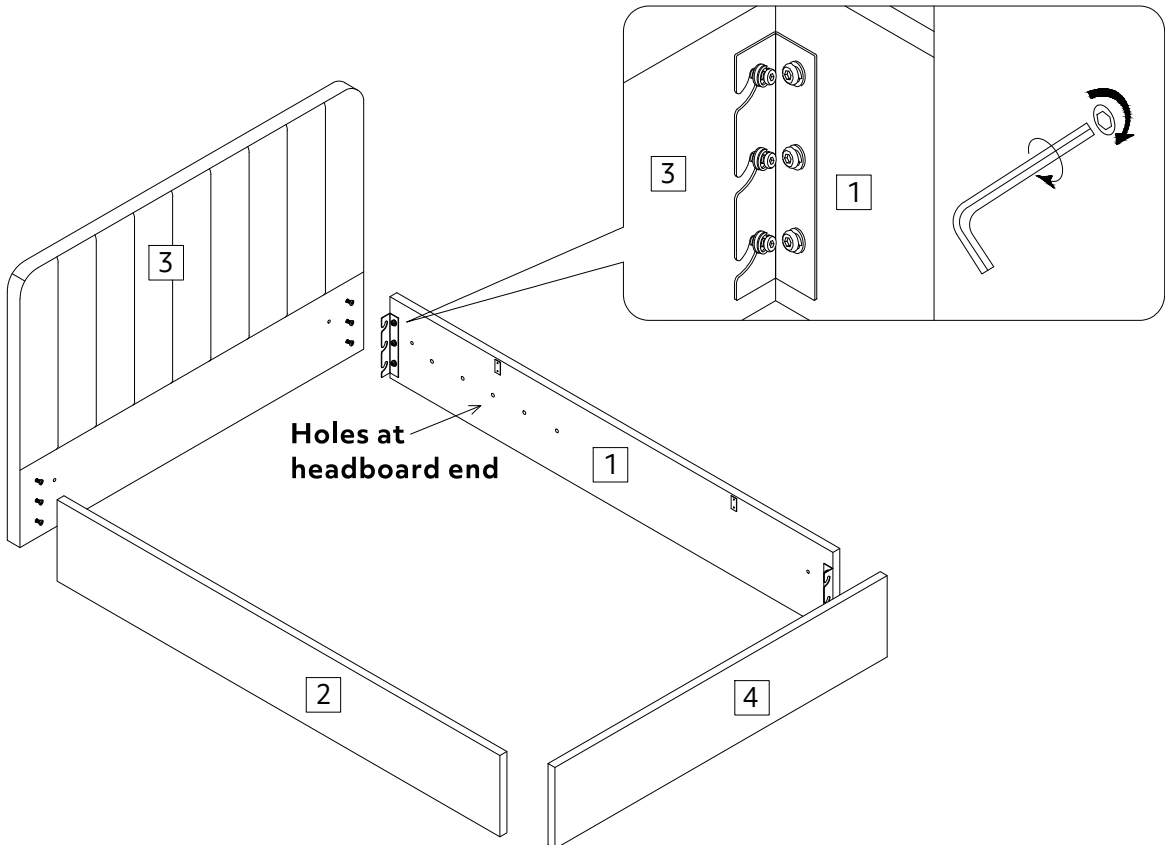

**Do not fully tighten fixings!**

# 5

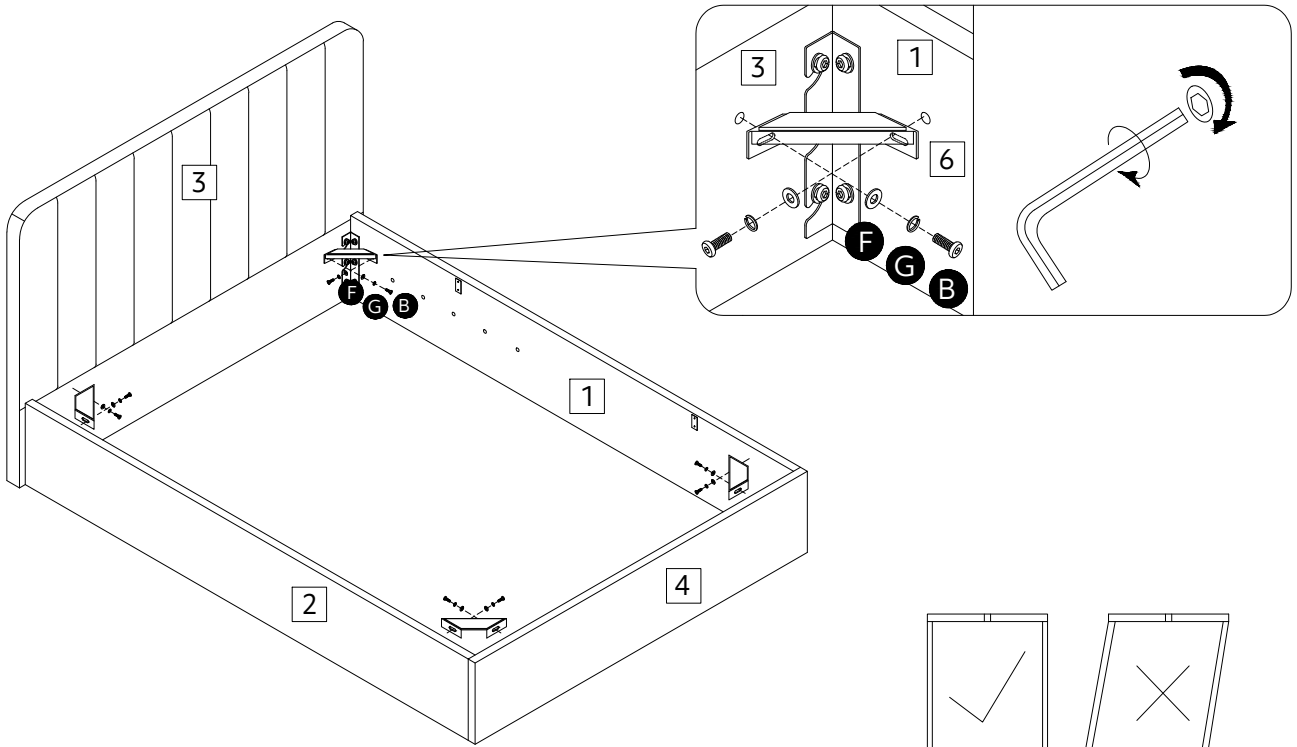
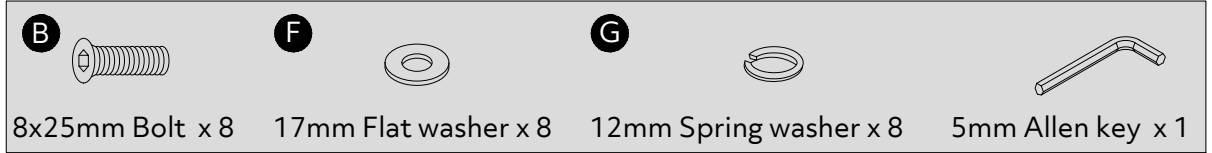

Ensure frame is square

# 6

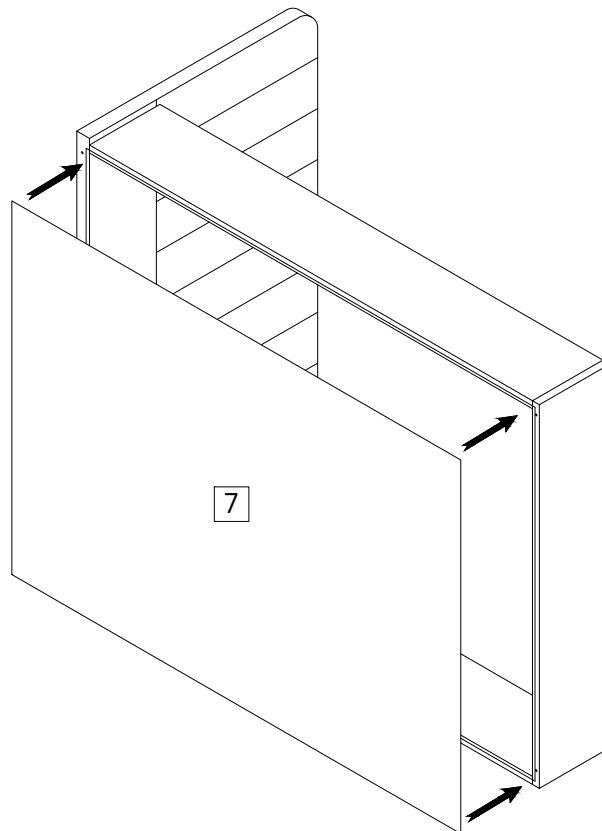

Velcro fastening

# 7

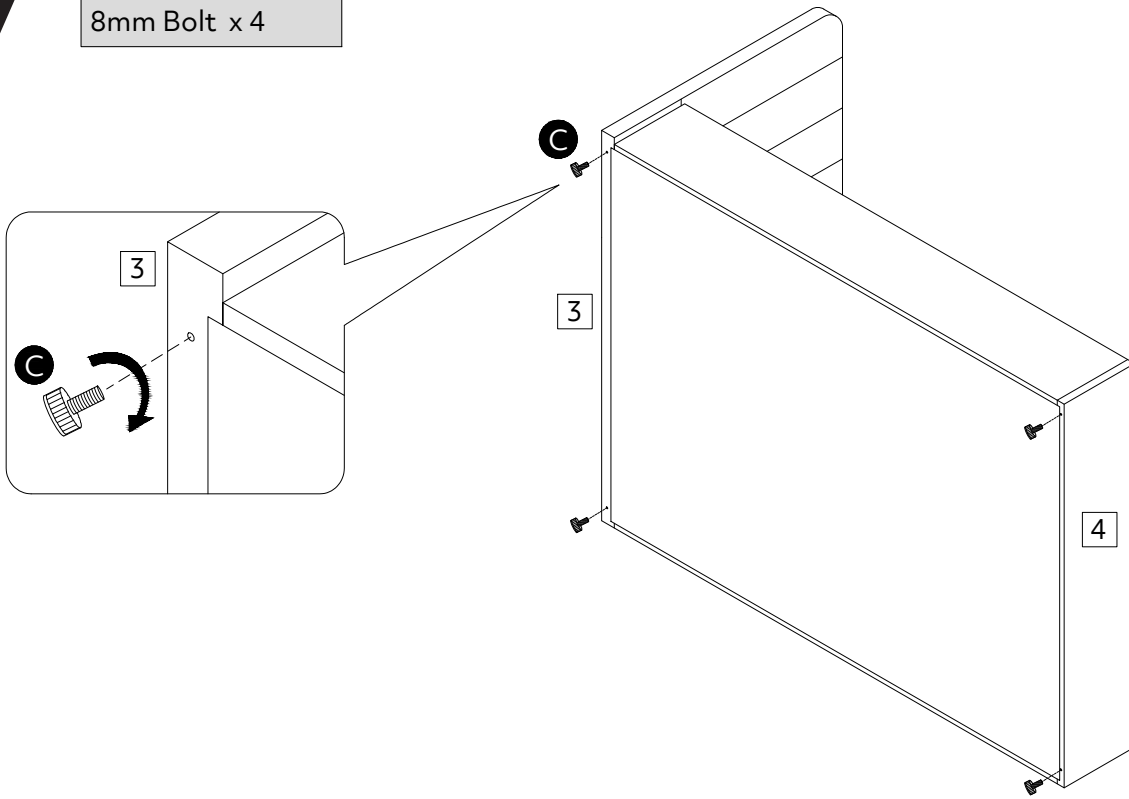
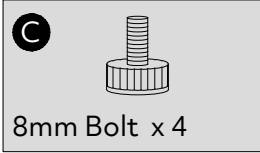

# 8

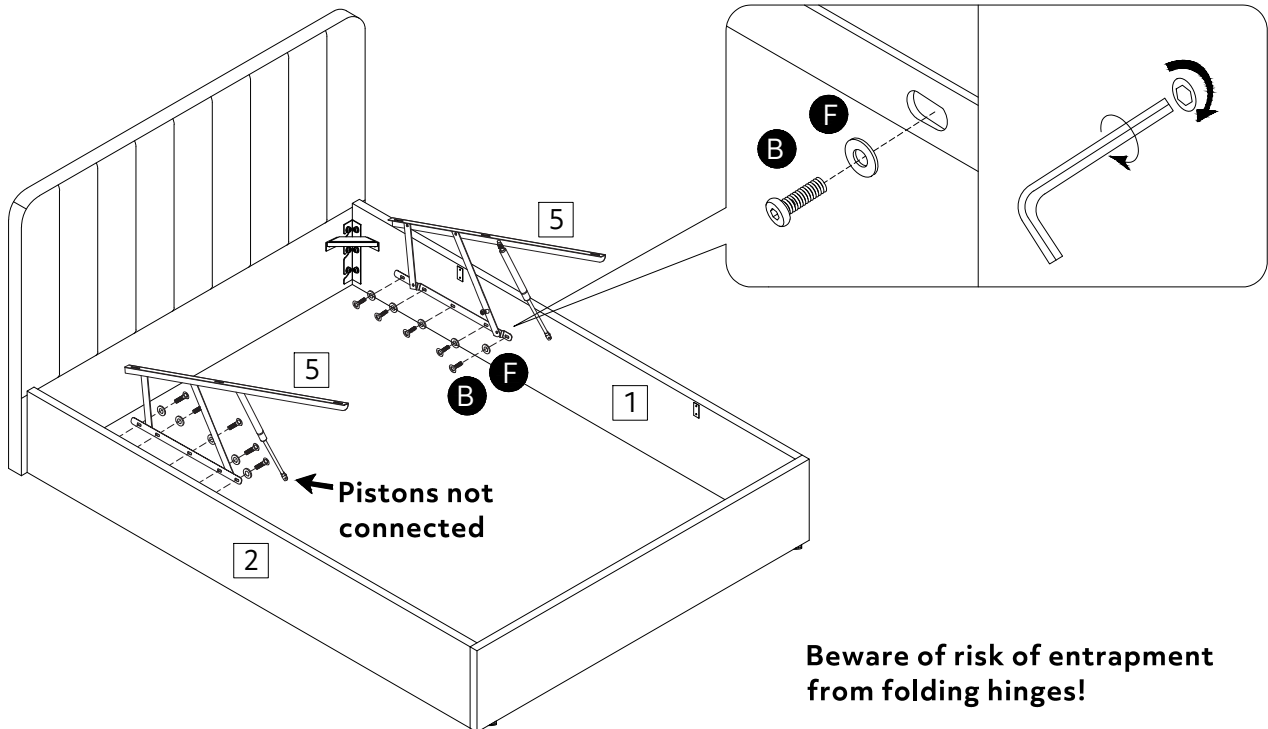
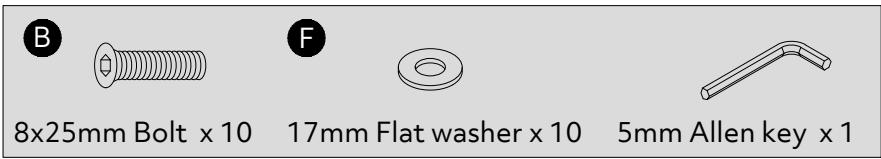

**Beware of risk of entrapment from folding hinges!**

**Note: Pistons not connected at this stage!**

# 9

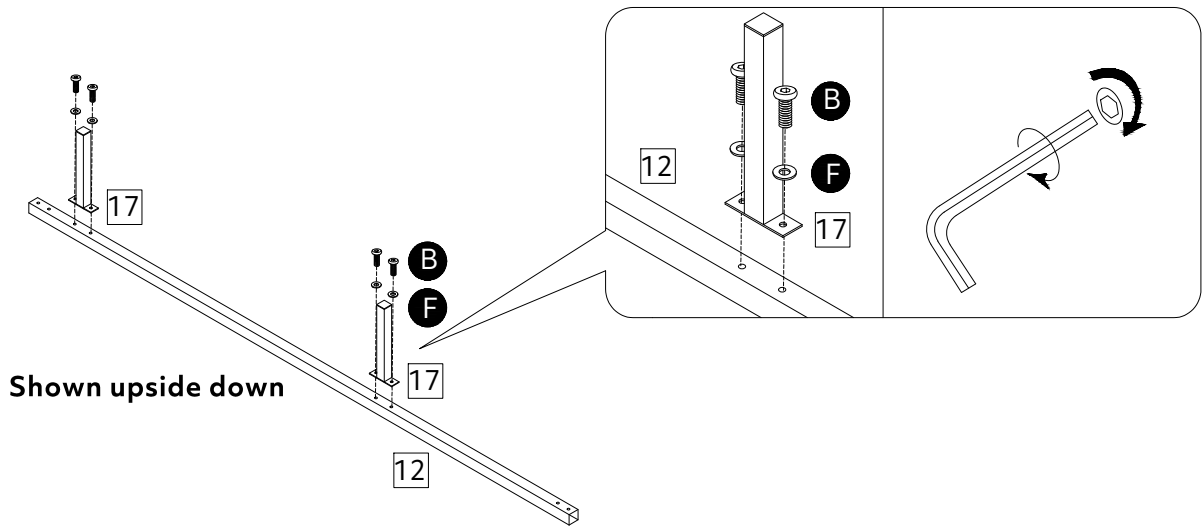
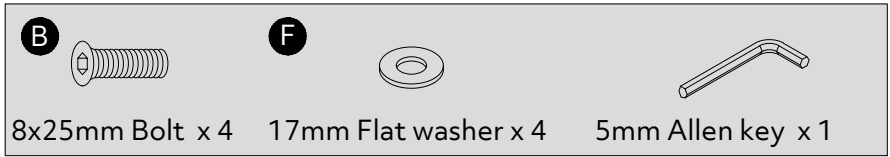

# 10

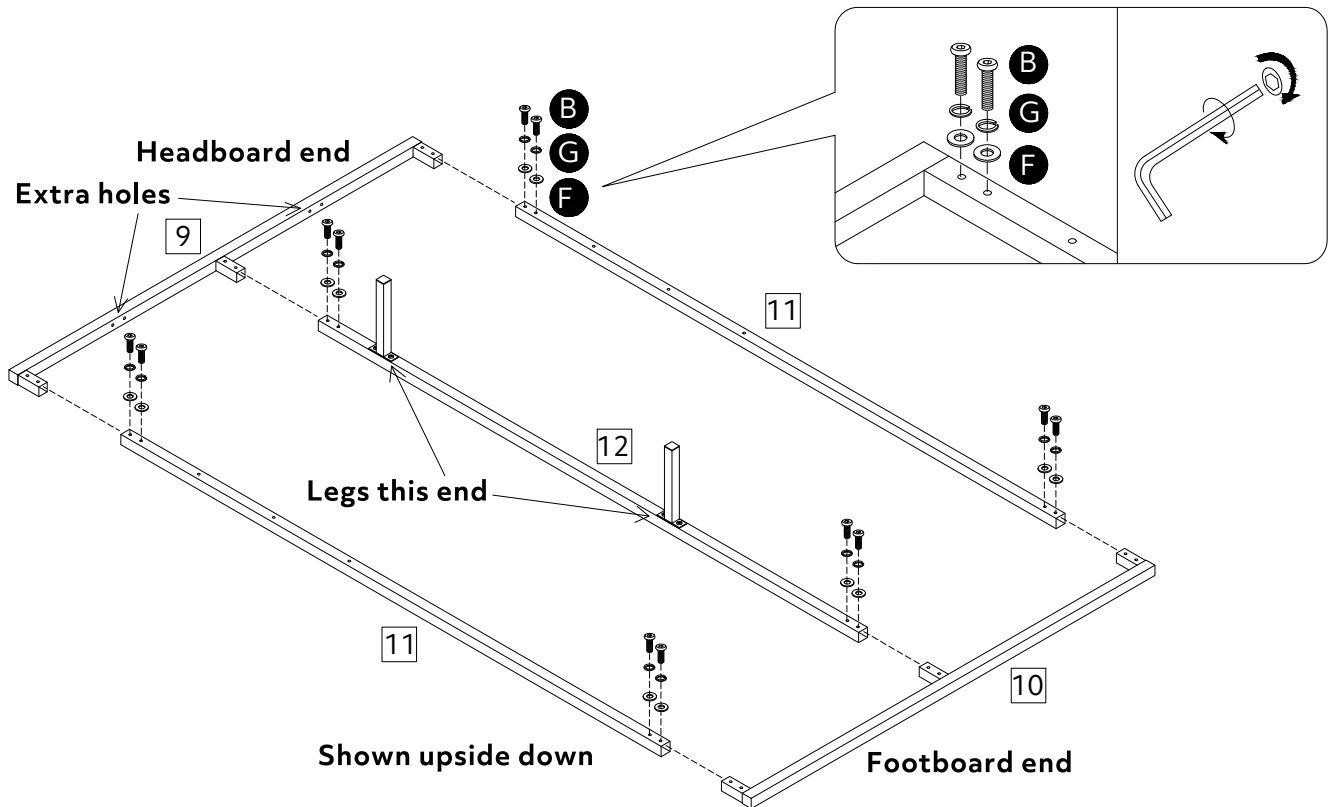
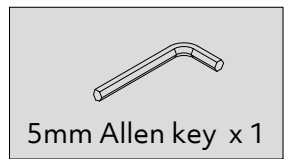
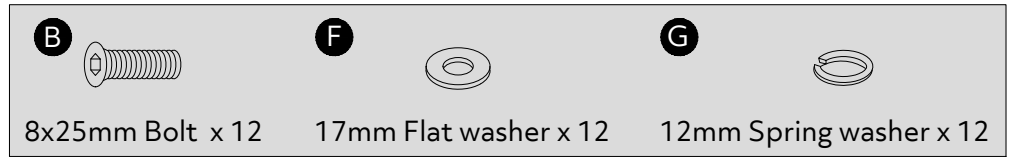



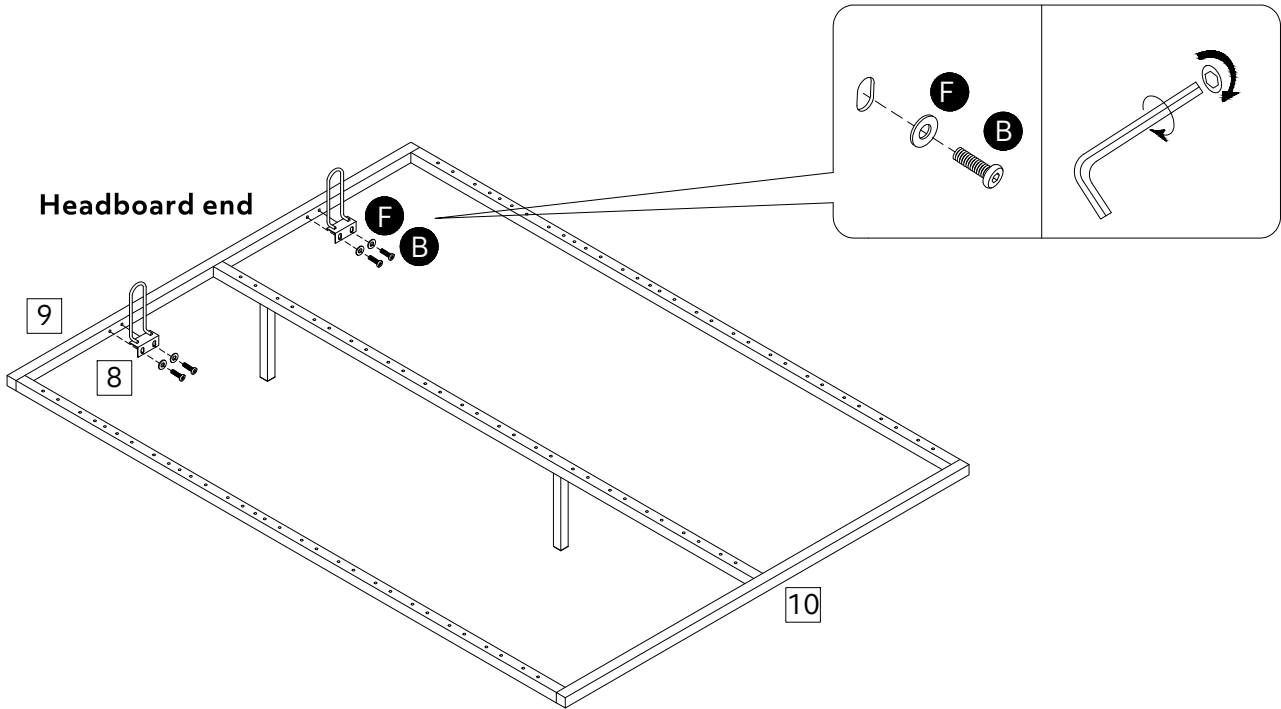

# 11

**B**  **F**    
8x25mm Bolt x 4 17mm Flat washer x 4 5mm Allen key x 1



# 12

**A**  **E**  **F**    
8x45mm Bolt x 6 Nut x 6 17mm Flat washer x 6 5mm Allen key x 1

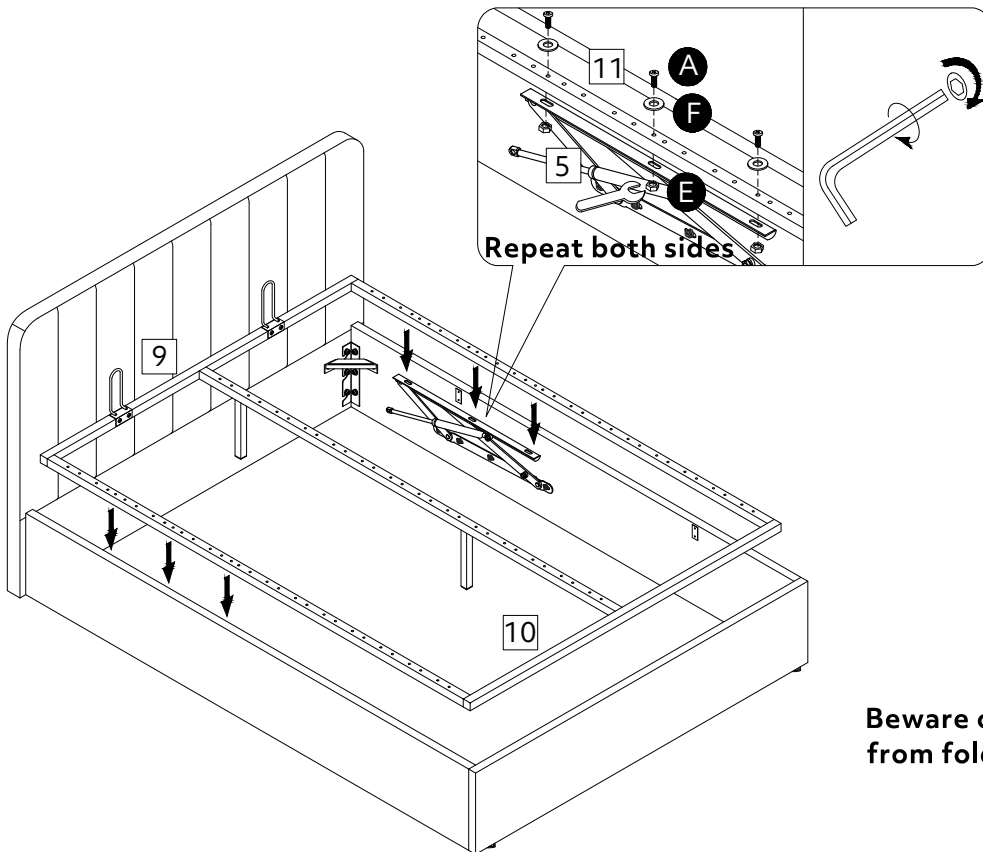
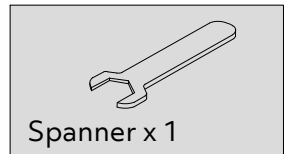

**Beware of risk of entrapment from folding hinges!**

# 13

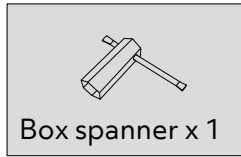

**Important:** Two people required.  
Frame to be fully supported at  
all times!

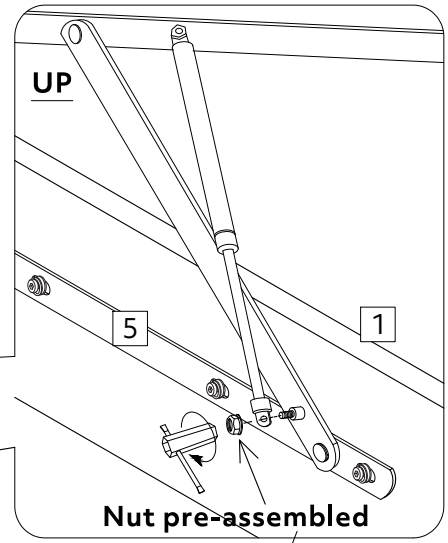
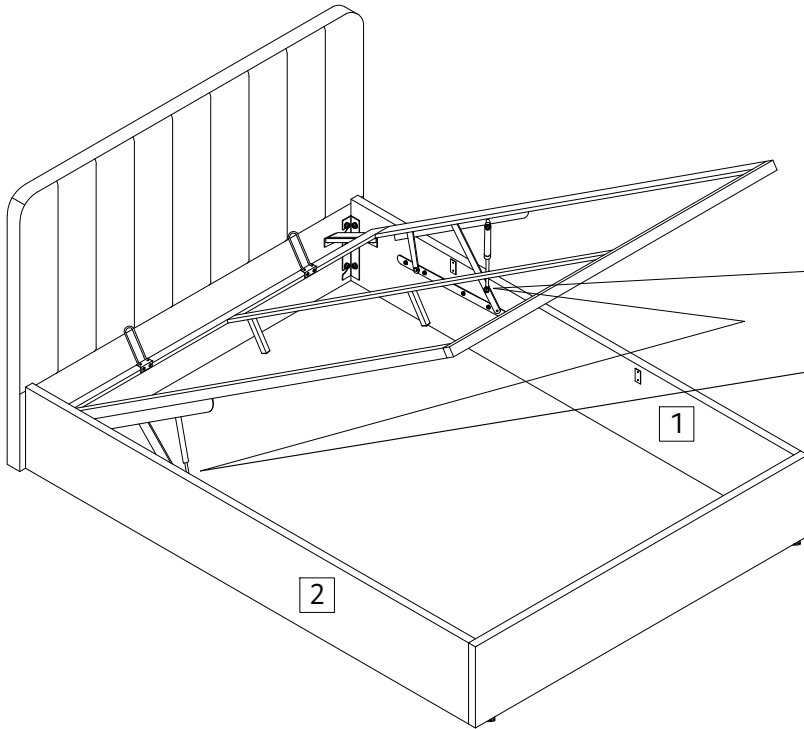

Repeat both sides

**Important:** Before proceeding,  
check and ensure all screws and  
fixings are fully tightened.

# 14

Repeat  
x14  
4'/4'6

Repeat  
x15  
5'

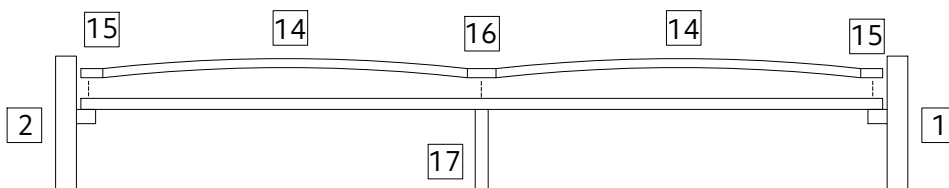
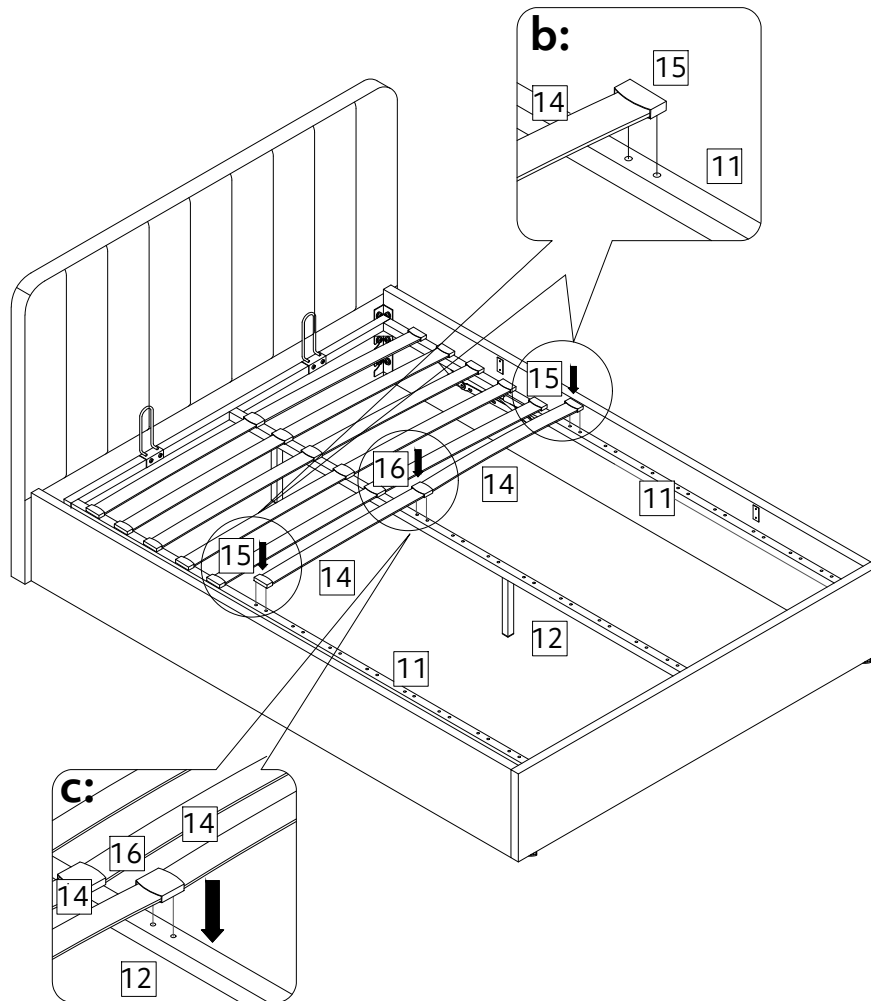
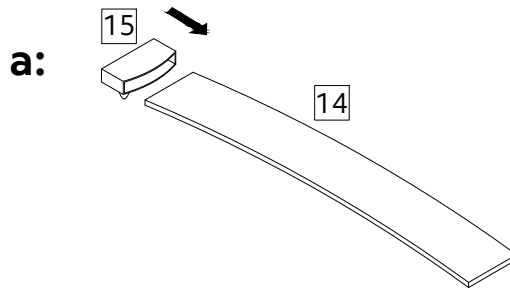

Slats to arch upwards