

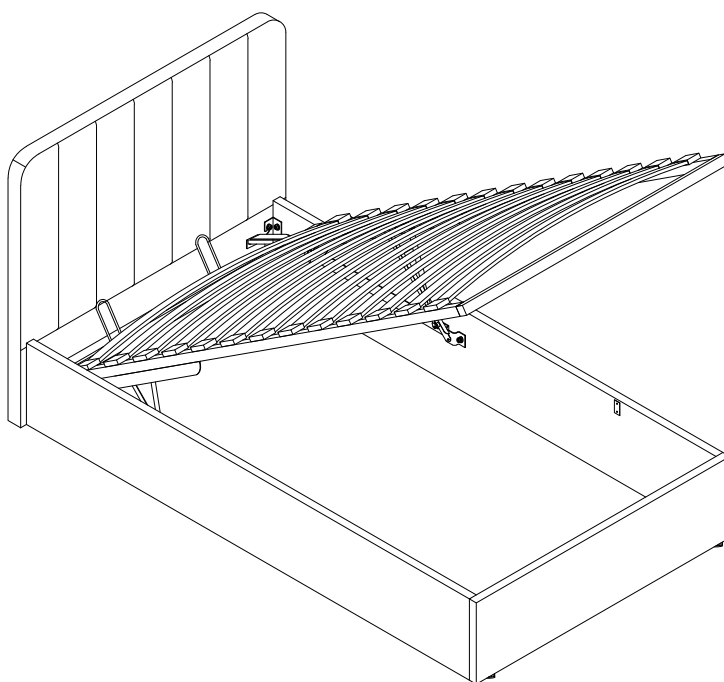

Pandora



Spare Parts

 www.argos-support.co.uk

 Help@ClickSpares.co.uk

 0370 112 1928

Customer Support

 0345 640 2020

 argos.co.uk/help/contact-us



Safety and Care Advice

Product Details

Silver Grey 337/8588

Blush Pink 299/8866

Cream 775/8197

Taupe 768/4632

Blue Black 775/7521

IMPORTANT, RETAIN FOR FUTURE REFERENCE: READ CAREFULLY.

- Keep children and animals away from the work area, small parts could choke if swallowed.

- Make sure you have enough space to layout the parts before starting.

- This product has been constructed to be used in the domestic environment only and not for commercial purposes.

- Assemble the item as close to its final position (in the same room) as possible.

- Assemble on a soft level surface to avoid damaging the unit or your floor.

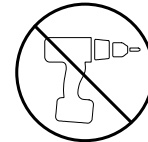

- We do not recommend the use of power drill/drivers for inserting screws as this could damage the unit. Only use hand screwdrivers.

- Parts of the assembly will be easier with 2 people.

- Dispose of all packaging carefully and responsibly.

Cleaning Guidance

- Minor stains and spillages should be removed immediately from cushion fabric, by wiping over lightly with a damp cloth and mild soapy water.

- Light marking can also be removed using this method.

- To remove more stubborn stains or marking, a good quality proprietary domestic fabric cleaner can be used, although it should first be tested on an inconspicuous area of the fabric.

Important Ottoman Safety Warnings

- Caution. This bed uses a pressurised mechanism.
- Use caution when operating - Always use two hands at arm's length, and only where illustrated on the product.
- You must ensure the mattress is on the frame before lifting the mechanism - Failure to do so may result in injury.
- Please ensure Children and pets are kept away from the bed when operating the bed mechanism.
- If removing the mattress, make sure that the frame is secured as it could flip open.
- Only use the storage compartment when when the frame is fully raised in the 'up' position.
- No children or animals are left unattended when the frame is in the 'up' position.
- Do not remain on the bed whilst the lifting mechanism is in use.
- Beware of Entrapment - Keep both hands clear of mechanism when operating the mechanism.
- When lifting the bed remove all bedding - Except the fitted sheet.
- Only suitable for persons aged 13 years +.

Information For Use

	Single Size 3'0
Mattress Size	900x1900mm
Maximum Mattress Weight	40KG

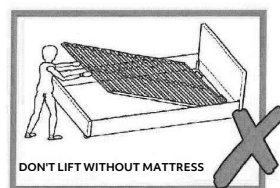

Sainsbury's Supermarkets Ltd and Argos Limited, London EC1M 6HA, UK. Sainsbury's (NI) Ltd and Argos (N.I.) Ltd, Forestside Shopping Centre, Upper Galwally, Belfast, BT8 6FX, UK.

Fittings (Shown to scale)

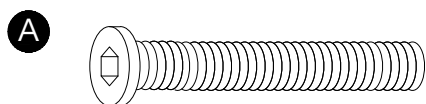

8x45mm Bolt x 6

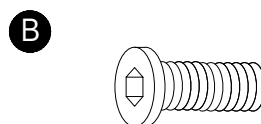

8x25mm Bolt x 42

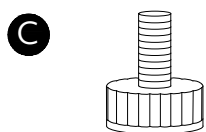

8mm Bolt x 4



12mm Spring washer x 28

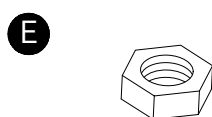

Nut x 6



17mm Flat washer x 48

Note: All fittings packed inside the back of the headboard

Parts

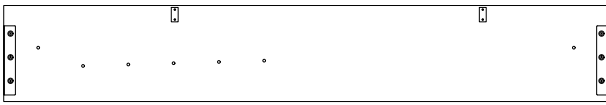

1 Right side rail x 1 (1930 x 305mm)



2 Left side rail x 1 (1930 x 305mm)

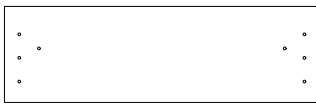

4 Footboard x1 (1000 x 305mm)
Note: Packed inside the back of the headboard

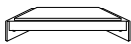

6 Metal corner plate x 4 (169 x 35mm)
Note: Packed inside the back of the headboard

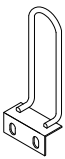

8 Mattress support bracket x 2
Note: Packed inside the back of the headboard



10 Ottoman end frame (Footboard) x 1 (910 x 85mm)
Note: Packed inside the back of the headboard



12 Bentwood slats x 14 (903 x 9 x 53mm)
Note: Packed inside the back of the headboard

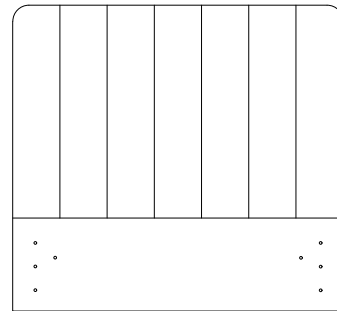

3 Headboard x1 (1050 x 980mm)

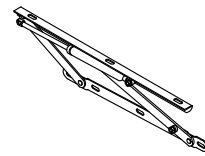

5 Hinge Mechanism (x 1 pair)
NOTE: PISTON ATTACHED

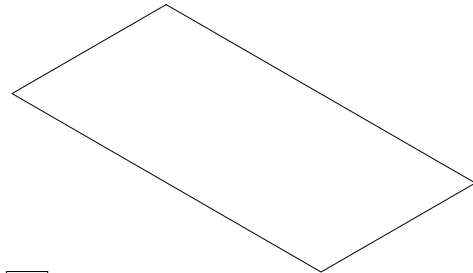

7 Fabric base x 1 (1965 x 980mm)
Note: Packed inside the back of the headboard

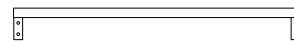

9 Ottoman end frame (Headboard) x 1 (910 x 85mm)
NOTE: EXTRA HOLES
Note: Packed inside the back of the headboard



11 Ottoman frame (Sides) x 2 (1822 x 30mm)



13 Single slat caps x 28 (55mm)
Note: Packed inside the back of the headboard

Tools required

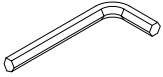

Allen key (Supplied)

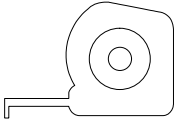

Ruler/tape measure

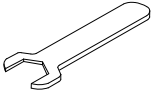

Spanner (Supplied)

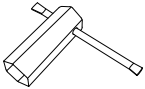

Box spanner (Supplied)

1

Components packed inside back of headboard

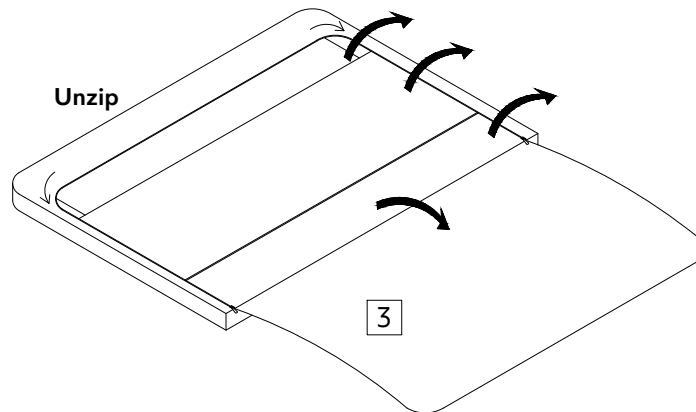

WARNING!
The headboard is heavy.
Lift with care.

Shown upside down

2

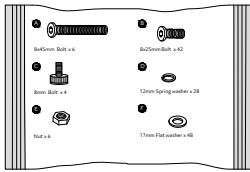

B		D		F	
8x25mm Bolt x 12		12mm Spring washer x 12		17mm Flat washer x 12	

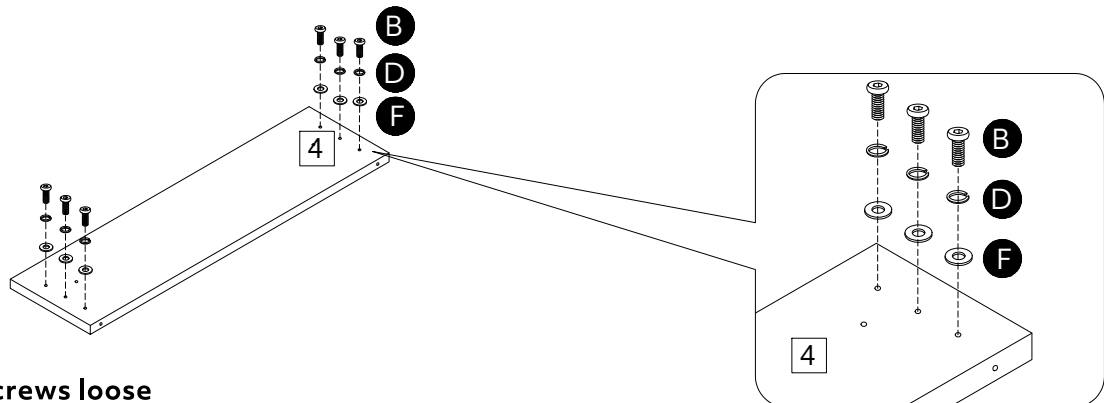
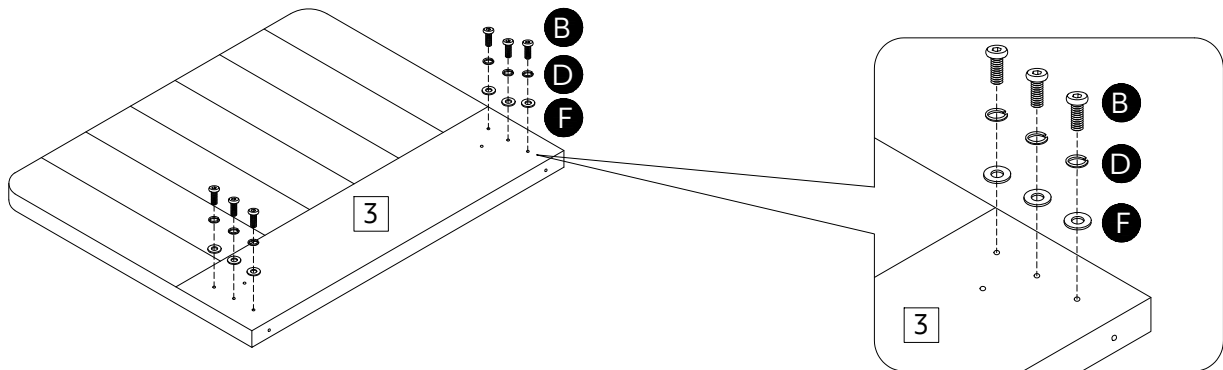

Leave screws loose

3

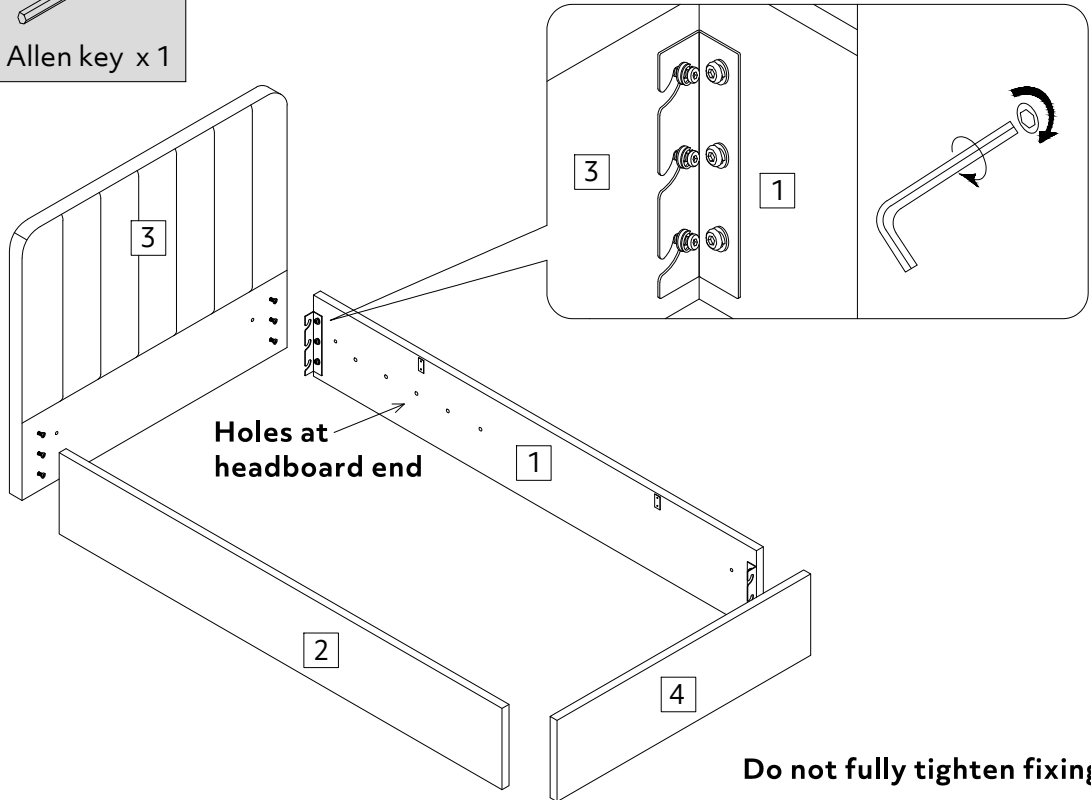
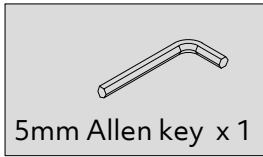

4

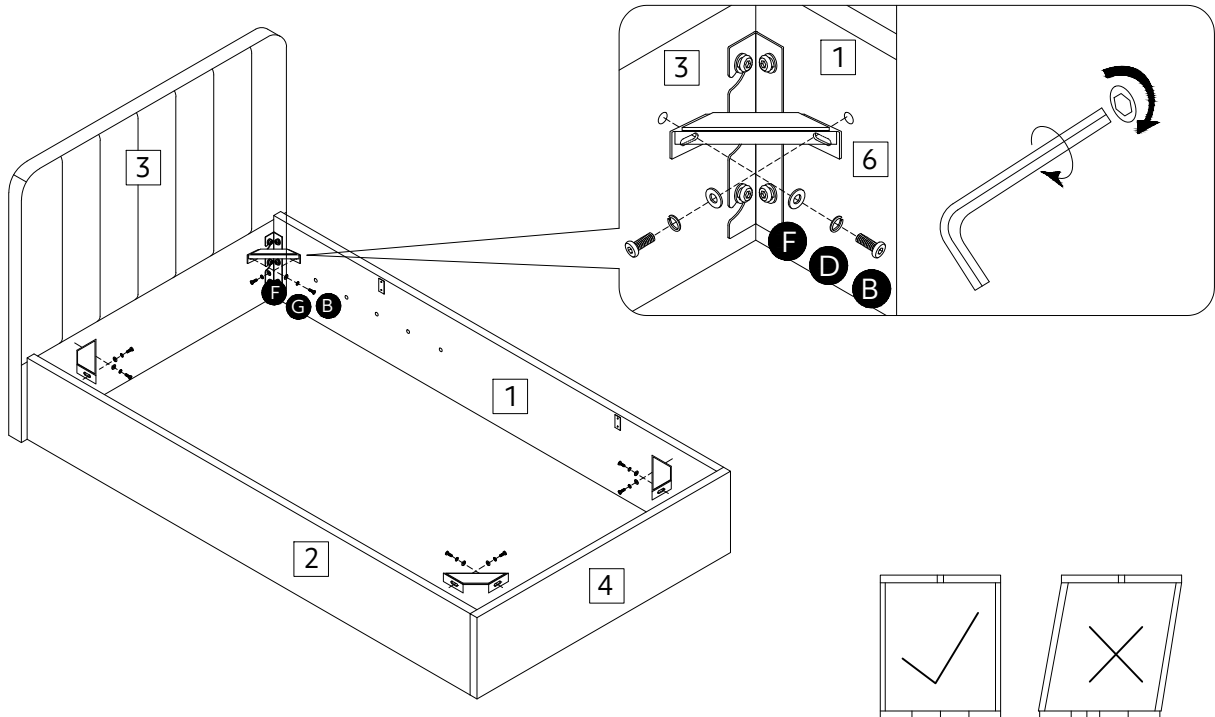
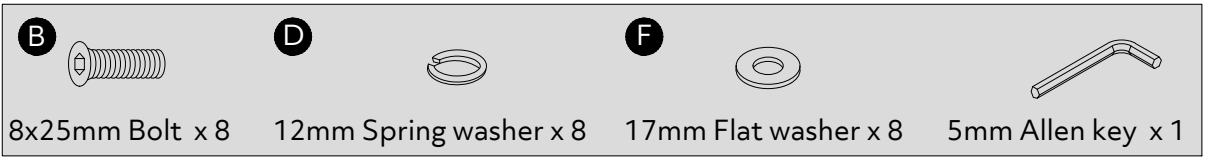

5

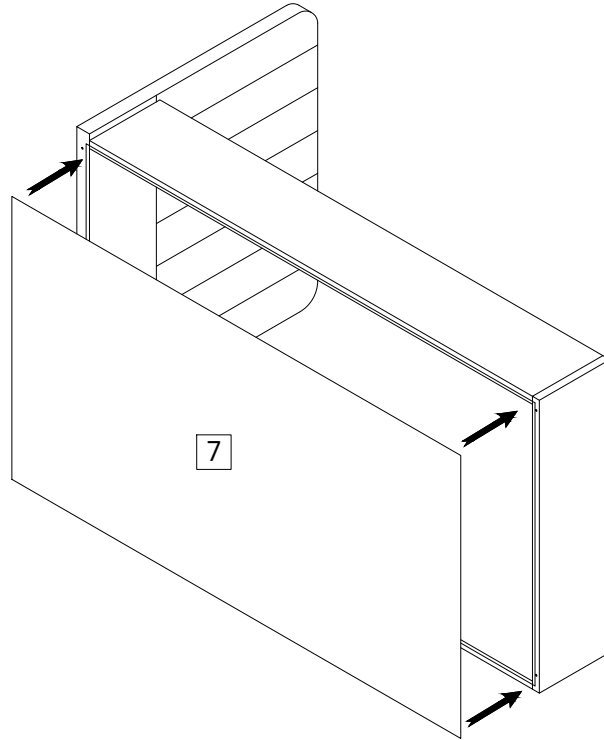

Velcro fastening

6

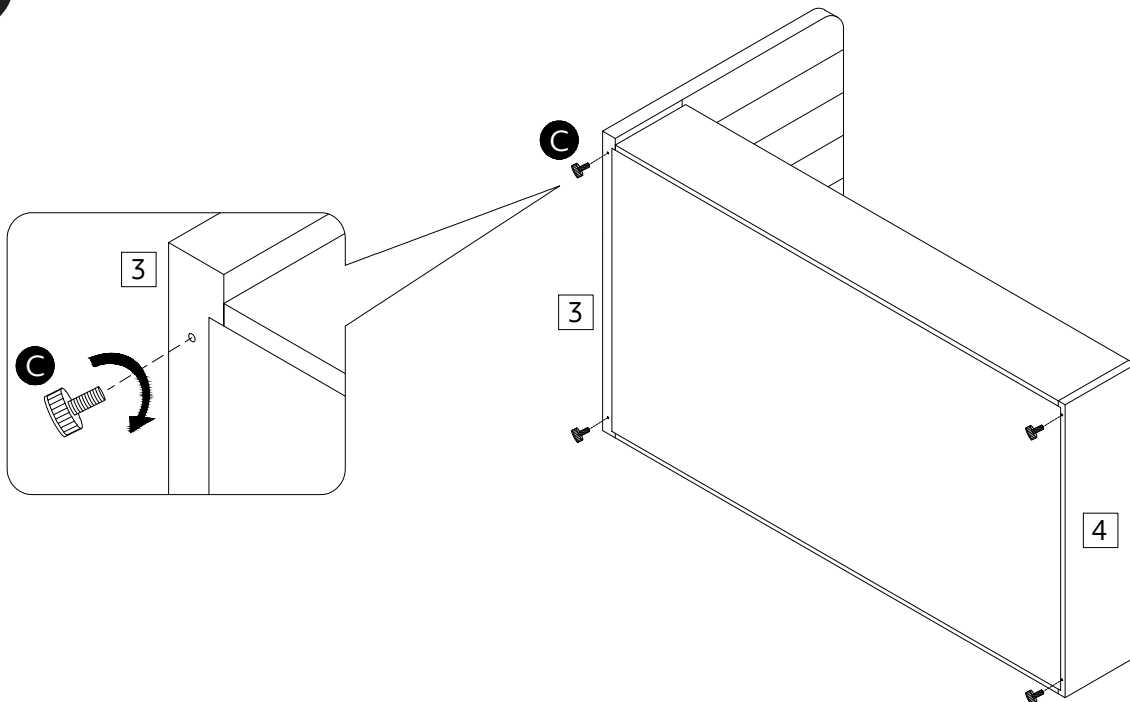
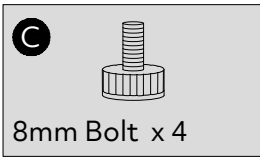

7



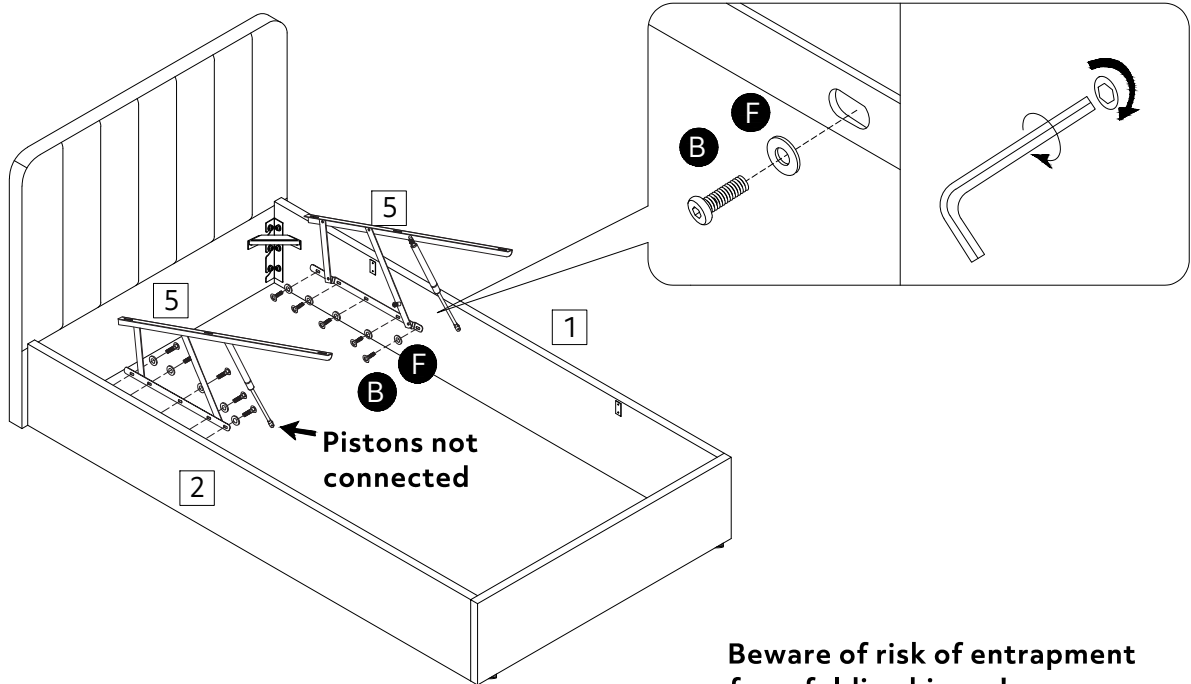

B		F		
8x25mm Bolt x 10 17mm Flat washer x 10 5mm Allen key x 1				



Beware of risk of entrapment from folding hinges!



Note: Pistons not connected at this stage!

8

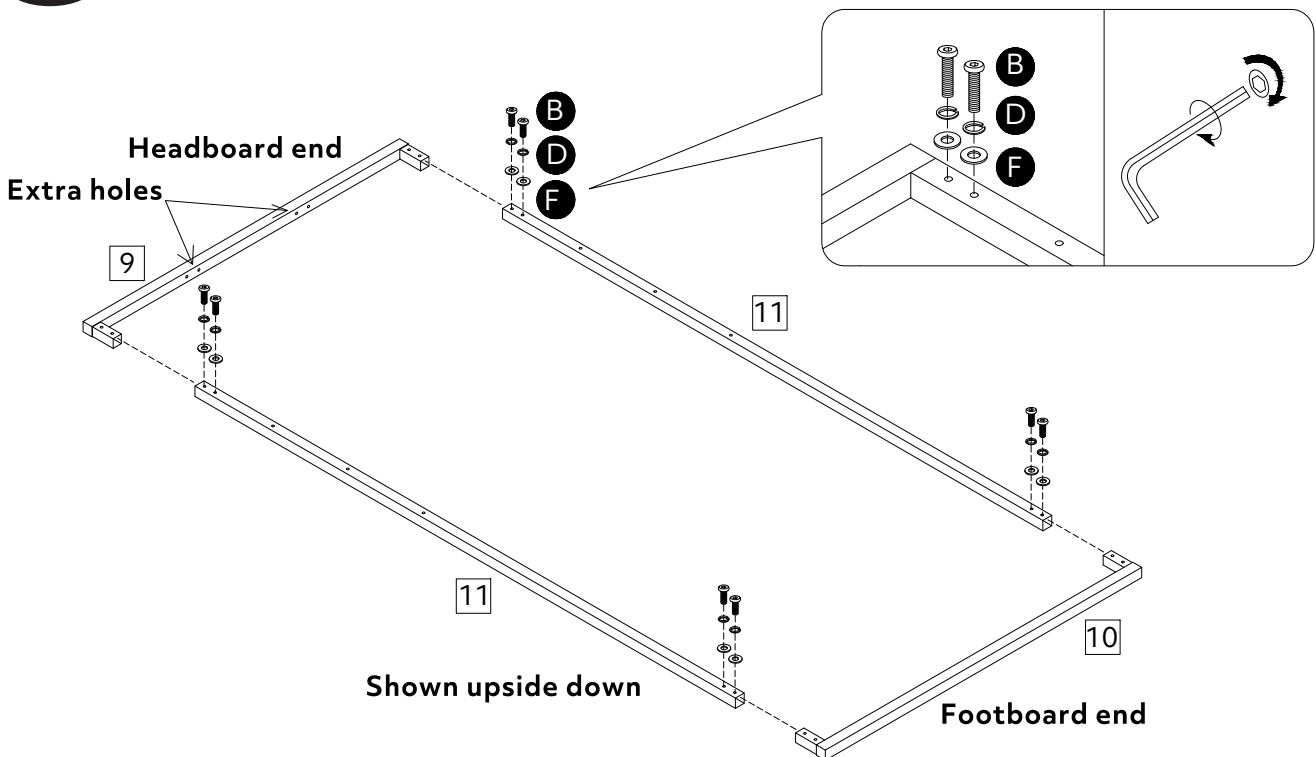
B		D		F		
8x25mm Bolt x 8 12mm Spring washer x 8 17mm Flat washer x 8 5mm Allen key x 1						



9





B		F		
8x25mm Bolt x 4 17mm Flat washer x 4 5mm Allen key x 1				

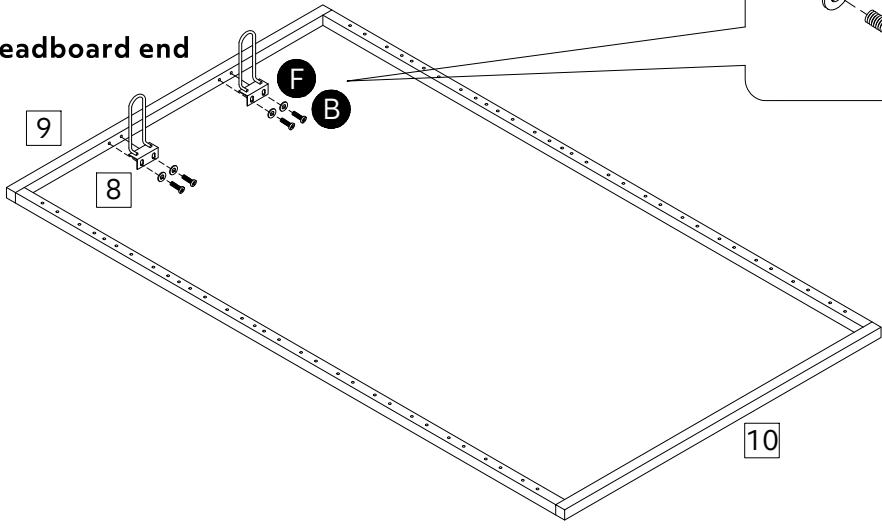

Headboard end



10

A		E		F		
8x45mm Bolt x 6 Nut x 6 17mm Flat washer x 6 5mm Allen key x 1						

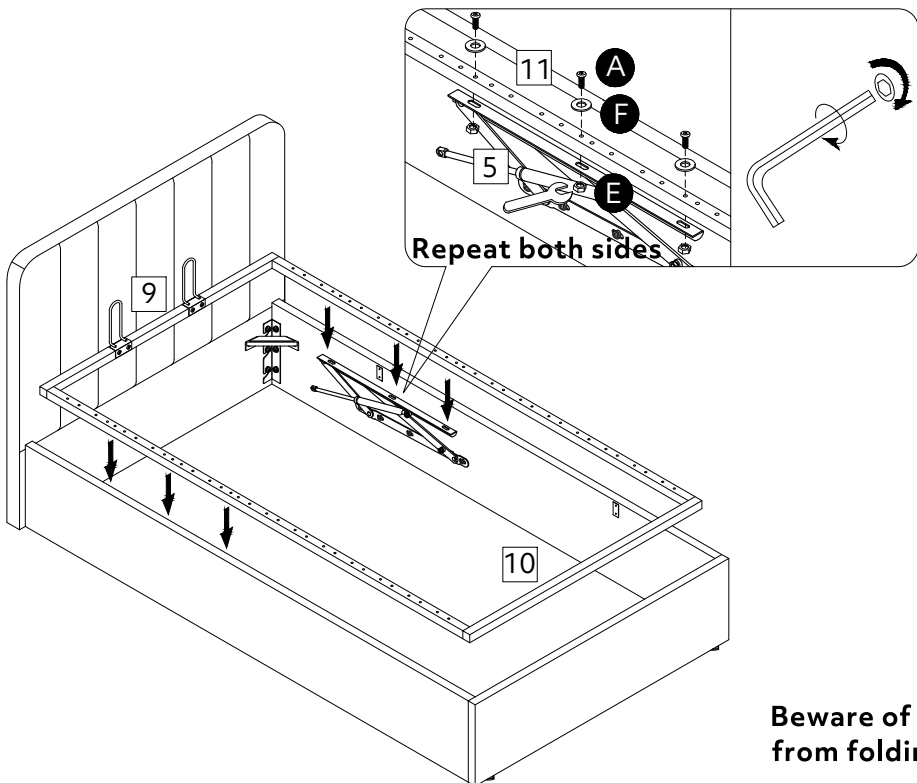
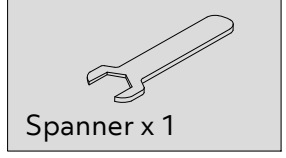

Beware of risk of entrapment from folding hinges!

11

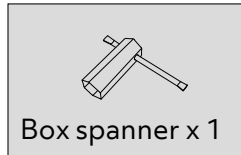

Important: Two people required.
Frame to be fully supported at
all times!

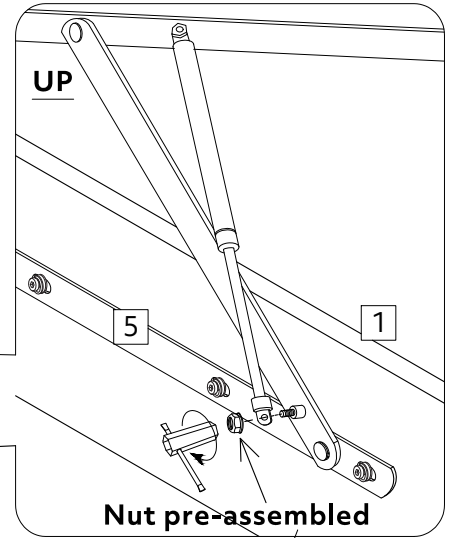
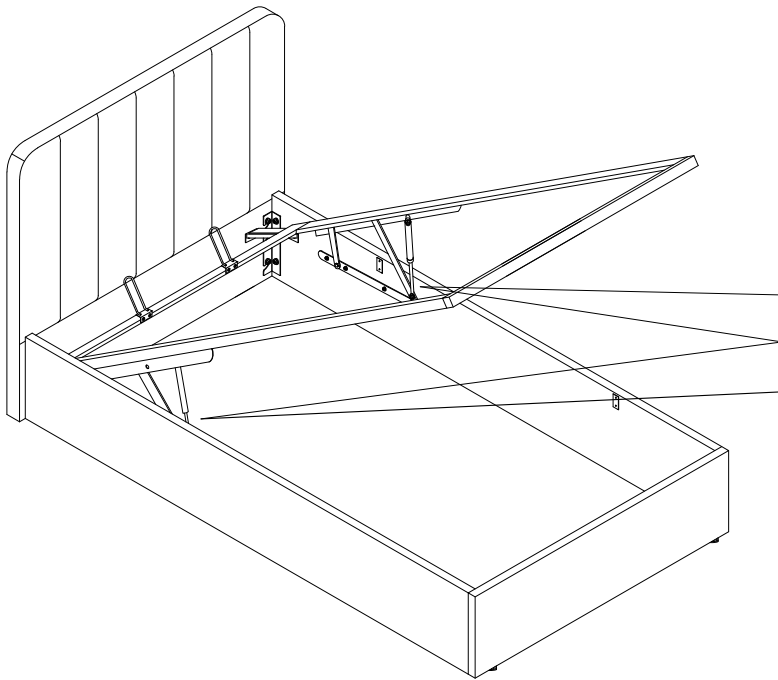

Repeat both sides

Important: Before proceeding,
check and ensure all screws and
fixings are fully tightened.

12

Repeat
x14

