

***BOSE***

---

**SMART** SOUNDBAR

**Please read and keep all safety and use instructions.**

**CE** Bose Corporation hereby declares that this product is in compliance with the essential requirements and other relevant provisions of Directive 2014/53/EU and all other applicable EU directive requirements. The complete declaration of conformity can be found at: [www.Bose.com/compliance](http://www.Bose.com/compliance)

**UK CA** This product conforms to all applicable Electromagnetic Compatibility Regulations 2016 and all other applicable UK regulations. The complete declaration of conformity can be found at: [www.Bose.com/compliance](http://www.Bose.com/compliance)

Bose Corporation hereby declares that this product is in compliance with the essential requirements per Radio Equipment Regulations 2017 and all other applicable UK regulations. The complete declaration of conformity can be found at: [www.Bose.com/compliance](http://www.Bose.com/compliance)

**Important Safety Instructions**

Read these instructions.

Clean only with a dry cloth.

Do not block any ventilation openings. Install in accordance with the manufacturer's instructions.

Only use attachments/accessories specified by the manufacturer.

Refer all servicing to qualified personnel. Servicing is required when the apparatus has been damaged in any way, such as power-supply cord or plug is damaged, liquid has been spilled or objects have fallen into the apparatus, the apparatus has been exposed to rain or moisture, does not operate normally, or has been dropped.

**WARNINGS/CAUTIONS**



This symbol on the product means there is uninsulated, dangerous voltage within the product enclosure that may present a risk of electrical shock.



This symbol on the product means there are important operating and maintenance instructions in this guide.

<b>▲ WARNING</b>	
<ul style="list-style-type: none"> <li>• <b>INGESTION HAZARD:</b> This product contains a button cell or coin battery.</li> <li>• <b>DEATH</b> or serious injury can occur if ingested.</li> <li>• A swallowed button cell or coin battery can cause <b>Internal Chemical Burns</b> in as little as <b>2 hours</b>.</li> <li>• <b>KEEP</b> new and used batteries <b>OUT OF REACH OF CHILDREN</b></li> <li>• <b>Seek immediate medical attention</b> if a battery is suspected to be swallowed or inserted inside any part of the body.</li> </ul>	

- Do not ingest battery, chemical burn hazard.
- The remote control supplied with this product contains a coin/button cell battery. If the coin/button cell battery is swallowed, it can cause severe internal chemical burns in just 2 hours and can lead to death.
- Keep new and used batteries away from children.
- Even used batteries may cause severe injury or death.
- Always completely secure the battery compartment. If the battery compartment does not close securely, stop using the product, remove the batteries, and keep them away from children.
- Ensure the batteries are installed correctly according to polarity (+ and -).
- Do not mix old and new batteries, different brands or types of batteries, such as alkaline, carbon-zinc, or rechargeable batteries.

---

## IMPORTANT SAFETY INSTRUCTIONS

---

- If you think batteries might have been swallowed or placed inside any part of the body, seek immediate medical attention.
- Call a local poison control center for treatment information.
- To avoid risk of explosion, fire or chemical burn, use caution in replacing the battery and replace only with an agency approved battery.
- Remove and immediately recycle or dispose of used batteries according to local regulations and keep away from children. Do NOT dispose of batteries in household trash or incinerate.
- Remove and immediately recycle or dispose of batteries from equipment not used for an extended period of time according to local regulations.
- Do not force discharge, recharge, disassemble, heat above 185° F (85° C) or incinerate. Doing so may result in injury due to venting, leakage or explosion resulting in chemical burns.
- Non-rechargeable batteries are not to be recharged.
- Battery Type: CR2032 | Nominal battery voltage: 3V



Contains small parts which may be a choking hazard. Not suitable for children under age 3.



This product contains magnetic material. Consult your physician on whether this might affect your implantable medical device.

- To reduce the risk of fire or electrical shock, do NOT expose this product to rain, dripping, splashing, or moisture and do not place liquid filled objects such as vases, on or near the product.
- Keep the product away from fire and heat sources. Do NOT place naked flame sources, such as lighted candles, on or near the product.
- Do NOT make unauthorized alterations to this product.
- Do NOT use a power inverter with this product.
- Do NOT use in vehicles or boats.
- Where the mains plug or an appliance coupler is used as the disconnect device, the disconnect device shall remain readily operable.
- The battery provided with this product may present a risk of fire, explosion or chemical burn if mishandled, incorrectly replaced or replaced with an incorrect type.
- Only use the following hardware to mount this product: Bose Soundbar Wall Bracket.
- When positioning the product, make sure it is not blocking any ventilation openings on your TV or monitor. Refer to the owner's guide that came with your TV or monitor and install in accordance with the manufacturer's instructions.
- Due to ventilation requirements, Bose does not recommend placing the product in a confined space such as in a wall cavity or in an enclosed cabinet.
- Do not place or install near any heat sources, such as fireplaces, radiators, heat registers, stoves, or other apparatus (including amplifiers) that produce heat.
- Keep batteries out of reach of children.
- Batteries may cause a fire or chemical burn if mishandled. Do not recharge, disassemble, heat, or incinerate.

**NOTE:** This equipment has been tested and found to comply with the limits for a Class B digital device, pursuant to Part 15 of the FCC Rules. These limits are designed to provide reasonable protection against harmful interference in a residential installation. This equipment generates, uses, and can radiate radio frequency energy and, if not installed and used in accordance with the instructions, may cause harmful interference to radio communications. However, there is no guarantee that interference will not occur in a particular installation. If this equipment does cause harmful interference to radio or television reception, which can be determined by turning the equipment off and on, the user is encouraged to try to correct the interference by one or more of the following measures:

- Reorient or relocate the receiving product or antenna.
- Increase the separation between the equipment and receiver.
- Connect the equipment into an outlet on a circuit different from that to which the receiver is connected.
- Consult the dealer or an experienced radio/TV technician for help.

Changes or modifications not expressly approved by Bose Corporation could void the user's authority to operate this equipment.

This device complies with part 15 of the FCC Rules and with ISED Canada license-exempt RSS standard(s). Operation is subject to the following two conditions: (1) This device may not cause harmful interference, and (2) this device must accept any interference received, including interference that may cause undesired operation.

This equipment should be installed and operated with a minimum distance of 20 cm between radiator and your body.

This device for operation in the 5150 – 5250 MHz is only for indoor use to reduce the potential for harmful interference to co-channel mobile satellite systems.

CAN ICES-3(B)/NMB-3(B)

**For Europe:** Frequency bands of operation 2400 to 2483.5 MHz, 5150 to 5350 MHz, and 5470 to 5725 MHz. | Maximum transmit power less than 20 dBm EIRP. | Frequency band of operation 5725 to 5850 MHz. | Maximum transmit power less than 14 dBm (25mW) EIRP.

Maximum transmit power is below regulatory limits such that SAR testing is not necessary and exempt per applicable regulations.

This device is restricted to indoor use when operating in the 5150 to 5350 MHz frequency range in all EU Member States listed in the table.

									
BE	DK	IE	UK(NI)	FR	CY	SK	HU	AT	SE
BG	DE	PT	EL	HR	LV	LT	MT	PL	
CZ	EE	FI	ES	IT	RO	LU	NL	SI	



This symbol means the product must not be discarded as household waste, and should be delivered to an appropriate collection facility for recycling. Proper disposal and recycling helps protect natural resources, human health and the environment. For more information on disposal and recycling of this product, contact your local municipality, disposal service, or the shop where you bought this product.

## Low-power Radio-frequency Devices Technical Regulations

Without permission granted by the NCC, any company, enterprise, or user is not allowed to change frequency, enhance transmitting power or alter original characteristic as well as performance to an approved low power radio-frequency devices. The low power radio-frequency devices shall not influence aircraft security and interfere legal communications; If found, the user shall cease operating immediately until no interference is achieved. The said legal communications means radio communications is operated in compliance with the Telecommunications Management Act. The low power radio-frequency devices must be susceptible with the interference from legal communications or ISM radio wave radiated devices.

### Product Power State Table

The product, in accordance with the Ecodesign Requirements for Energy Related Products Directive 2009/125/EC and the Ecodesign for Energy-Related Products and Energy Information (Amendment) (EU Exit) Regulations 2020, is in compliance with the following norm(s) or document(s): Regulation (EC) No. 1275/2008, as amended by Regulation (EU) No. 801/2013.

Required Power State Information	Power Modes	
	Standby	Networked Standby
Power consumption in specified power mode, at 230V/50Hz input  Time after which equipment is automatically switched into mode  Power consumption in networked standby if all wired network ports are connected and all wireless network ports are activated, at 230V/50Hz input	< 0.5 W  < 2.5 hours  N/A	all network types ≤ 2.0 W  ≤ 20 minutes  ≤ 2.0 W
Wireless network port activation/deactivation procedures. Deactivating all networks will enable standby mode.	<b>Wi-Fi®:</b> Activate using the Bose app. Deactivate by pressing and holding the Mute and <i>Bluetooth</i> buttons on the remote simultaneously.  <b>Bluetooth®:</b> Activate by pairing with a <i>Bluetooth</i> source by pressing the <i>Bluetooth</i> button on the remote then selecting the soundbar in your device <i>Bluetooth</i> list or by using the Bose app. Deactivate by clearing the pairing list by pressing and holding the <i>Bluetooth</i> button on the remote for 10 seconds.	



廢電池請回收

Please dispose of used batteries properly, following local regulations. Do not incinerate.



Li-ion

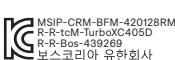

MSP-CRM-BFM-420128RM  
 R-R-toM-TurboXC405D  
 R-R-Bos-439269  
 보스코리아 유한회사

Names and Contents of Toxic or Hazardous Substances or Elements						
Toxic or Hazardous Substances and Elements						
Part Name	Lead (Pb)	Mercury (Hg)	Cadmium (Cd)	Hexavalent (CR(VI))	Polybrominated Biphenyl (PBB)	Polybrominated diphenylether (PBDE)
PCBs	X	O	O	O	O	O
Metal Parts	X	O	O	O	O	O
Plastic Parts	O	O	O	O	O	O
Speakers	X	O	O	O	O	O
Cables	X	O	O	O	O	O
This table is prepared in accordance with the provisions of SJ/T 11364. O: Indicates that this toxic or hazardous substance contained in all of the homogeneous materials for this part is below the limit requirement of GB/T 26572. X: Indicates that this toxic or hazardous substance contained in at least one of the homogeneous materials used for this part is above the limit requirement of GB/T 26572.						

Equipment name: Powered Speaker, Type designation: 439269						
Restricted substances and its chemical symbols						
Unit	Lead (Pb)	Mercury (Hg)	Cadmium (Cd)	Hexavalent chromium (Cr <sup>+6</sup> )	Polybrominated biphenyls (PBB)	Polybrominated diphenyl ethers (PBDE)
PCBs	-	o	o	o	o	o
Metal Parts	-	o	o	o	o	o
Plastic Parts	o	o	o	o	o	o
Speakers	-	o	o	o	o	o
Cables	-	o	o	o	o	o
<b>Note 1:</b> "o" indicates that the percentage content of the restricted substance does not exceed the percentage of reference value of presence. <b>Note 2:</b> The "-" indicates that the restricted substance corresponds to the exemption.						

**Date of Manufacture:** The eighth digit in the serial number indicates the year of manufacture; "4" is 2014 or 2024.

**Importers:** Bose Electronics (Shanghai) Company Limited, Level 6, Tower D, No. 2337 Gudai Rd. Minhang District, Shanghai 201100 | Bose Products B.V., Gorslaan 60, 1441 RG Purmerend, The Netherlands | Bose de México S. de R.L. de C.V., Avenida Prado Sur #150, Piso 2, Interior 222 y 223, Colonia Lomas de Chapultepec V Sección, Miguel Hidalgo, Ciudad de México, C.P. 11000 Phone Number: +5255 (5202) 3545 | Bose Limited (H.K.), 7F., No. 2, Sec. 3, Minsheng E. Road, Zhongshan Dist. Taipei City 10480, Phone Number: +886-2-2514 7676 | Bose Limited, Bose House, Quayside Chatham Maritime, Chatham, Kent, ME4 4QZ, United Kingdom

**Input Rating:** 100 - 240V ~ 50/60Hz, 100W

The CMIIT ID is located on the product label on the back of the soundbar.

**Please complete and retain for your records**

The serial and model numbers are located on the back of the soundbar.

Serial number: \_\_\_\_\_

Model number: 439269

Please keep your receipt. Now is a good time to register your Bose product. You can easily do this by going to [worldwide.Bose.com/ProductRegistration](http://worldwide.Bose.com/ProductRegistration)

Amazon, Alexa, Amazon Music, and all related marks are trademarks of Amazon.com, Inc. or its affiliates.

Apple, the Apple logo, Apple Music, and AirPlay are trademarks of Apple Inc., registered in the U.S. and other countries. App Store is a service mark of Apple Inc.

Use of the Works with Apple AirPlay badge means that an accessory has been designed to work specifically with the technology identified in the badge and has been certified by the developer to meet Apple performance standards.

The *Bluetooth*<sup>®</sup> word mark and logos are registered trademarks owned by Bluetooth SIG, Inc. and any use of such marks by Bose Corporation is under license.

 Dolby, Dolby Atmos, and the double-D symbol are registered trademarks of Dolby Laboratories Licensing Corporation. Manufactured under license from Dolby Laboratories. Confidential unpublished works. Copyright © 2012-2021 Dolby Laboratories. All rights reserved.

Google, Google Cast, and Google Play are trademarks of Google LLC.

 The terms HDMI, HDMI High-Definition Multimedia Interface, HDMI Trade dress and the HDMI Logos are trademarks or registered trademarks of HDMI Licensing Administrator, Inc.

This product contains the iHeartRadio service. iHeartRadio is a registered trademark of iHeartMedia, Inc.

This product is protected by certain intellectual property rights of Microsoft. Use or distribution of such technology outside of this product is prohibited without a license from Microsoft.

Pandora is a trademark or registered trademark of Pandora Media, Inc. used with permission.

QuickSet is a registered trademark of Universal Electronics Inc. in the United States and Internationally.

© UEI 2000-2024

 Roku TV, Roku TV Ready, and the Roku TV Ready logo are trademarks of Roku, Inc. This product is Roku TV Ready-supported in the United States, Brazil, Canada, Mexico, and the United Kingdom. Countries are subject to change. For the most current list of countries in which this product is Roku TV Ready-supported, please email [rokutvready@roku.com](mailto:rokutvready@roku.com)

This product incorporates Spotify software which is subject to third-party licenses found here:

[www.spotify.com/connect/third-party-licenses](http://www.spotify.com/connect/third-party-licenses)

Spotify is a registered trademark of Spotify AB.

Wi-Fi is a registered trademark of Wi-Fi Alliance<sup>®</sup>.

Bose, the B logo, QuietComfort, SimpleSync, SoundLink, SoundLink Revolve, and Voice4Video are trademarks of Bose Corporation.

Bose Corporation Headquarters: 1-877-230-5639

©2024 Bose Corporation. No part of this work may be reproduced, modified, distributed, or otherwise used without prior written permission.

To view the license disclosures that apply to the third-party software packages included as components of your Bose Smart Soundbar product:

1. On the remote, press and hold the Play/Pause button ▶|| and Volume up button + for 5 seconds.
2. Connect a USB cable to the SERVICE connector on the back of the soundbar.
3. Connect the other end of the cable to a computer.
4. On the computer, enter <http://203.0.113.1/opensource> in a browser window to display the EULA and license disclosure.

**WHAT'S IN THE BOX**

Contents ..... 13

**DOLBY ATMOS® TECHNOLOGY** ..... 14

**SOUNDBAR PLACEMENT**

Recommendations ..... 15  
 Wall mount the soundbar ..... 16  
     Adjust audio for wall mounting ..... 17

**SET UP THE SOUNDBAR**

Connect the soundbar to power ..... 18  
 Network standby ..... 18

**BOSE APP SETUP**

Download the Bose app ..... 19

**EXISTING BOSE APP USERS**

Add the soundbar to an existing account ..... 20  
 Connect to a different Wi-Fi® network ..... 20

**SOUNDBAR CONTROLS**

Remote functions ..... 21  
     Power on/off ..... 22  
     Auto-wake (optical connection only) ..... 22  
     Sources ..... 23  
     Media playback and volume ..... 24  
 Voice assistant controls ..... 25  
 Adjust the audio ..... 25  
 AI Dialogue Mode ..... 25

## **AMAZON ALEXA**

Access Amazon Alexa.....	26
Use your voice.....	26
Use the soundbar controls.....	27
Calling and Messaging with Amazon Alexa.....	28
Set up Alexa Calling and Messaging.....	28
Use your voice.....	28
Set up Do Not Disturb.....	29
Use your voice.....	29
Control audio with Bose Voice4Video.....	30
Set up Voice4Video.....	30
Use your voice.....	30

## **WORKS WITH GOOGLE ASSISTANT**

Access Google Assistant.....	32
------------------------------	----

## **STREAM AUDIO WITH GOOGLE CAST..... 33**

## **STREAM AUDIO WITH AIRPLAY**

Stream audio from the Control Center.....	34
Stream audio from an app.....	34

## **BLUETOOTH® CONNECTIONS**

Connect a device.....	35
Disconnect a device.....	36
Reconnect a device.....	36
Connect an additional device.....	36
Clear the soundbar device list.....	36

**SOUNDBAR STATUS**

Wi-Fi status ..... 37

*Bluetooth* status ..... 37

Amazon Alexa status ..... 38

    Microphone off light ..... 39

Media playback and volume status ..... 39

Update and error status ..... 40

**ADVANCED FEATURES**

Disable/enable Wi-Fi capability ..... 41

**CONNECT BOSE PRODUCTS**

Connect accessories (optional) ..... 42

Connect a Bose SoundLink *Bluetooth* speaker or Bose headphones  
using SimpleSync technology ..... 43

    Benefits ..... 43

    Compatible products ..... 43

    Connect using the Bose app ..... 44

Reconnect a Bose SoundLink *Bluetooth* speaker or Bose headphones ..... 44

Access Personal Surround with Bose Ultra Open Earbuds ..... 45

    Benefits ..... 45

    Disable Personal Surround ..... 45

    Adjust Personal Surround audio settings ..... 45

    Immersive Audio and shortcuts while Personal Surround is enabled ..... 45

**CARE AND MAINTENANCE**

Update the soundbar ..... 46

Replace the remote battery ..... 46

Clean the soundbar ..... 48

Replacement parts and accessories ..... 48

Limited warranty ..... 48

**TROUBLESHOOTING**

Try these solutions first..... 49

Other solutions..... 49

Restore the soundbar..... 57

**APPENDIX: SETUP REFERENCE**

Connection options ..... 58

Connect the soundbar to your TV..... 59

    Option 1 (preferred): HDMI eARC or ARC..... 59

    Option 2: Optical..... 60

Roku TV Ready™..... 61

Check for sound ..... 61

## CONTENTS

Confirm that the following parts are included:



Bose Smart Soundbar

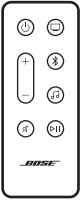

Remote (battery included)

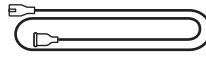

Power cord\*

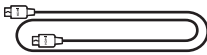

HDMI cable

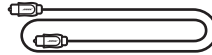

Optical cable

\* May ship with multiple power cords. Use the power cord for your region.

**NOTE:** If any part of the product is damaged, don't use it. Contact your authorized Bose dealer or Bose customer service.

Visit: [support.Bose.com/bssb](https://support.Bose.com/bssb)

The Bose Smart Soundbar supports Dolby Atmos® technology. The soundbar uses up-firing and side-firing speakers to deliver high-quality sound from all directions, achieving a superb, immersive, and fully-encompassing surround-sound experience.

**NOTE:** To deliver the Dolby Atmos surround-sound experience, connect the soundbar to the HDMI eARC or ARC port on your TV (see page 59). If your TV doesn't have an eARC or ARC port, you can connect the optical cable to the optical port to receive spacious and life-like sound (see page 60).

## RECOMMENDATIONS

- Place the soundbar below and in front of the TV (preferred) or above your TV with the front of the soundbar facing into the room.
- For best sound quality, make sure the up-firing speakers on the top of the soundbar and the side-firing speakers on the side of the soundbar aren't blocked.
- When the soundbar is mounted to the wall, make sure the top of the soundbar is at least 4 in (10 cm) away from the TV.
- If placing the soundbar on a shelf or TV stand, position the front of the soundbar as close as possible to the front edge of the shelf or stand for best sound quality.
- Place the soundbar outside of and away from metal cabinets, other audio/video components, and direct heat sources.
- Place the soundbar on its rubber feet on a stable and level surface. For proper support, both feet must be resting on the surface. Vibration can cause the soundbar to move, particularly on smooth surfaces like marble, glass, or highly polished wood.
- Keep the back side of the soundbar at least 0.4 in (1 cm) from any other surface. Blocking the port(s) affects sound quality.
- Make sure there is an AC (mains) outlet nearby.
- To avoid wireless interference, keep other wireless equipment at least 1 – 3 ft (0.3 – 0.9 m) away from the soundbar.
- To avoid wireless interference, some Wi-Fi access points may need to be placed up to 8 – 10 ft (2.4 – 3.0 m) away from the soundbar, optional bass module, and optional surround speakers.
- For best sound quality, don't place the soundbar in an enclosed cabinet or diagonally in a corner.
- Don't place any objects on top of the soundbar.

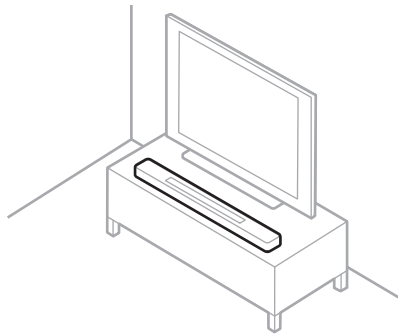

**CAUTION:** Do NOT place the soundbar on its front, back, or top when in use.

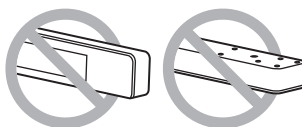

## WALL MOUNT THE SOUNDBAR

You can mount the soundbar on a wall. To purchase the Bose Soundbar Wall Bracket, contact your authorized Bose dealer.

Visit: [support.Bose.com/bssb](https://support.Bose.com/bssb)

**NOTE:** Make sure the top of the soundbar is at least 4 in (10 cm) away from the TV.

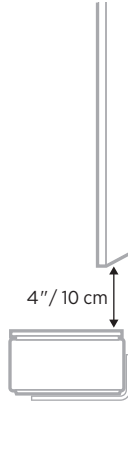

**CAUTION:** Do NOT use any other hardware to mount the soundbar.

## Adjust audio for wall mounting

After you mount the soundbar, you must adjust audio for best sound quality.

On the remote, press and hold the Mute button  for 5 seconds until you hear a tone and the light bar pulses white twice.

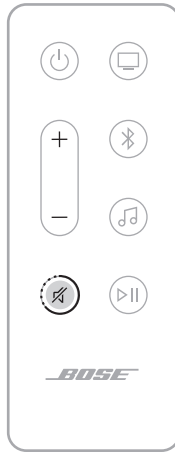

**NOTE:** If you remove the soundbar from the wall, repeat to return the soundbar to default audio settings.

**TIP:** You can also adjust audio for wall mounting using the Bose app.

## CONNECT THE SOUNDBAR TO POWER

1. Connect the power cord to the **POWER** port on the back of the soundbar.
2. Plug the other end of the power cord into an AC (mains) power outlet.

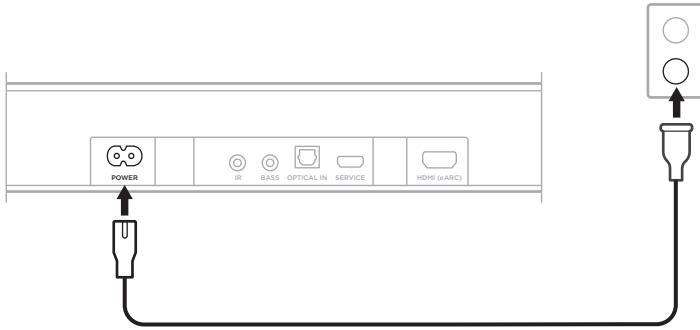



The soundbar powers on, and the light bar glows solid amber.

## NETWORK STANDBY

The soundbar transitions to network standby when audio has stopped and you have not pressed any buttons or talked to Amazon Alexa or your Google Assistant-enabled device for 20 minutes.

To wake the soundbar from network standby:

- On the remote, press the Power button , a source button (see page 23), or the Play/Pause button  (see page 21).
- Play or resume audio using your device or using the Bose app.
- Talk to Amazon Alexa or your Google Assistant-enabled device.

### NOTES:

- To access Amazon Alexa in network standby, make sure the soundbar has been set up using the Bose app (see page 19) and the microphone is on (see page 39).
- You can disable the standby timer using the Bose app. You can access this option from the Settings menu.

The Bose app lets you set up and control the soundbar from any mobile device, such as a smartphone or tablet.

Using the app, you can stream music, add music services, explore internet radio stations, configure Amazon Alexa, enable Google Cast, choose your voice prompt language, manage soundbar settings, and get any future updates and new features made available by Bose.

**NOTE:** If you have already created a Bose account for another Bose product, add the soundbar to your existing account (see page 20).

## DOWNLOAD THE BOSE APP

1. On your device, download the Bose app.

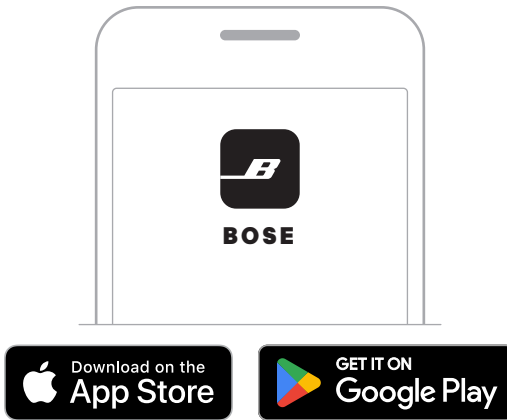



2. Follow the app instructions.

## ADD THE SOUNDBAR TO AN EXISTING ACCOUNT

To add your Bose Smart Soundbar, open the Bose app and add your soundbar.

## CONNECT TO A DIFFERENT WI-FI NETWORK

Connect to a different network if your network name or password has changed, or if you want to change or add another network.

1. On the remote, press and hold the Mute button  and Bose app button  until the light bar glows amber.



2. On your device, open your Wi-Fi settings.
3. Select **Bose Smart Soundbar**.
4. Open the Bose app and follow the app instructions.

**NOTE:** If the app doesn't prompt you for setup, go to the main screen and add the soundbar.

The soundbar controls are located on the top of the soundbar and on the remote.

**TIP:** You can also control your soundbar using the Bose app.

## REMOTE FUNCTIONS

Use the remote to control the soundbar, select the source, and manage *Bluetooth* connections.

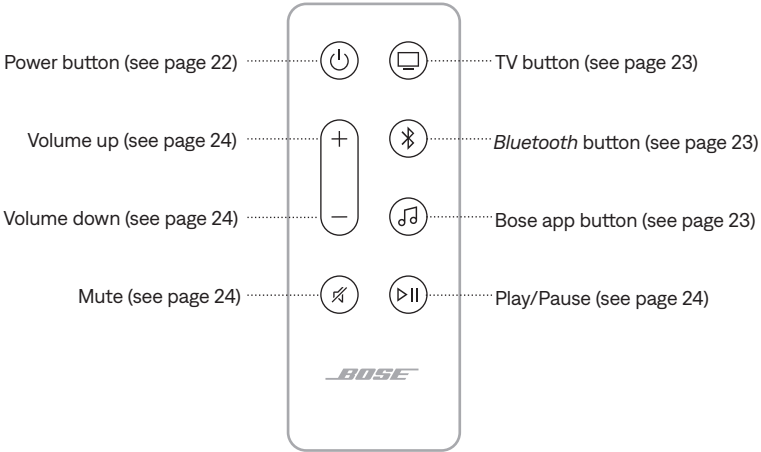

## Power on/off

On the remote, press the Power button  to power the soundbar on/off.

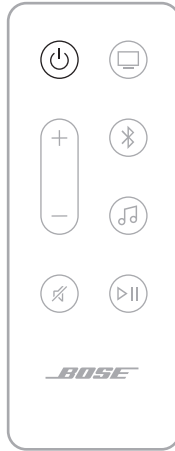

When powered on, the soundbar defaults to the TV source.

### NOTES:

- When you plug the soundbar into an AC (mains) outlet, the soundbar automatically powers on.
- When the soundbar is powered off, you can still use your voice to access Amazon Alexa or your Google Assistant-enabled device to control the soundbar (see page 26).

**TIP:** You can also use Bose Voice4Video along with Amazon Alexa to power the soundbar on/off (see page 30).



## Auto-wake (optical connection only)

You can set the soundbar to power on whenever a sound signal is received.

To toggle between auto-wake and default power settings, press and hold  for 10 seconds until you hear a tone and the light bar pulses white twice.

**TIP:** You can also control auto-wake using the Bose app. You can access this option from the Settings menu.

## Sources

On the remote, press the appropriate button (TV , *Bluetooth* , or Bose app ) to select the source.

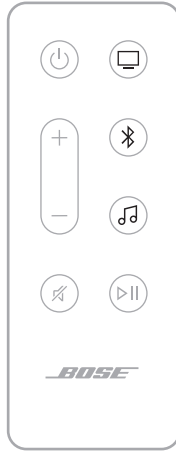

### TIPS:

- You can also use Bose Voice4Video along with Amazon Alexa to select your *Bluetooth* source (see page 30).
- You can also use the Bose app to select a source.

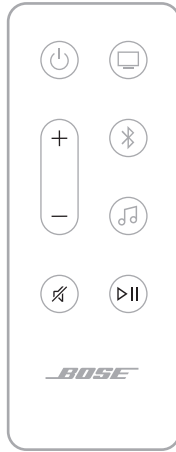

## Media playback and volume



FUNCTION	WHAT TO DO
<b>Play/Pause</b>	<p>Press ▷  .</p> <p><b>NOTES:</b></p> <ul style="list-style-type: none"> <li>• When audio is paused, two lights in the center of the light bar glow solid white until audio resumes.</li> <li>• You can't play/pause audio on a TV source.</li> </ul>
<b>Skip forward</b>	Double-press ▷  .
<b>Skip backward</b>	Triple-press ▷  .
<b>Volume up</b>	<p>Press +.</p> <p><b>NOTE:</b> To quickly increase the volume, press and hold +.</p>
<b>Volume down</b>	<p>Press -.</p> <p><b>NOTE:</b> To quickly decrease the volume, press and hold -.</p>
<b>Mute/Unmute</b>	<p>Press ✕.</p> <p>When audio is muted, the left end of the light bar glows solid white until audio resumes.</p> <p><b>TIP:</b> You can also press + to unmute audio.</p>

**TIP:** You can also use Bose Voice4Video along with Amazon Alexa to control media playback and volume for certain sources (see page 30).

## VOICE ASSISTANT CONTROLS

You can use the Action button  to control Amazon Alexa (page 27). You use the Microphone off button  to turn the microphone off (see page 27).

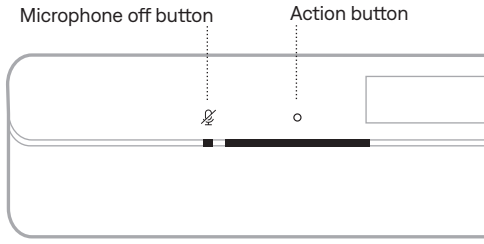

**TIP:** You can also use your voice to control Amazon Alexa (see page 26).

## ADJUST THE AUDIO

To adjust the bass, treble, center channel, height channel, and surround channels, use the Bose app. You can access these options from the Settings menu.

## AI DIALOGUE MODE

AI Dialogue Mode adjusts the audio to make voices easier to hear without reducing the impact of immersive sound effects.

To enable AI Dialogue Mode, use the Bose app. You can access this option from the Settings menu.

**NOTE:** When enabled, AI Dialogue Mode applies to content from all sources and remains enabled even if you power the soundbar off.

## ACCESS AMAZON ALEXA

With Alexa on your soundbar, you can simplify your life and use your voice to control your music and much more. Using Alexa is as easy as asking a question. Just ask and Alexa can play your favorite song, skip to the next track, change the volume, read you the news and more. Alexa on your soundbar makes it easier than ever to control your smart home, just by using your voice.

For more information about what Alexa can do, visit:

<https://www.amazon.com/usealexa>

To set up Amazon Alexa on the soundbar, use the Bose app. You can access this option from the Settings menu.

### NOTES:

- Alexa isn't available in all languages and countries. Alexa features and functionality may vary by location.
- When setting up Alexa, make sure you use the same audio service account that you used in the Bose app.
- If you have multiple Bose products in your household, for a seamless voice assistant experience, Bose recommends one person use their Bose account and Amazon Alexa account to set up Alexa for all Bose products.



## Use your voice

Start with "Alexa," then say:



THINGS TO TRY	EXAMPLES OF WHAT TO SAY
Talk to Alexa	Help me get started.
Play audio	Play rock music. <b>NOTE:</b> Amazon Music is set as the default music service. To change the default music service, use the Alexa app.
Pause audio	Pause.
Control volume	Turn the volume up.
Skip to the next song	Skip.
Play from a specific audio service	Play NPR on TuneIn. <b>NOTE:</b> Amazon Alexa doesn't support all audio services.

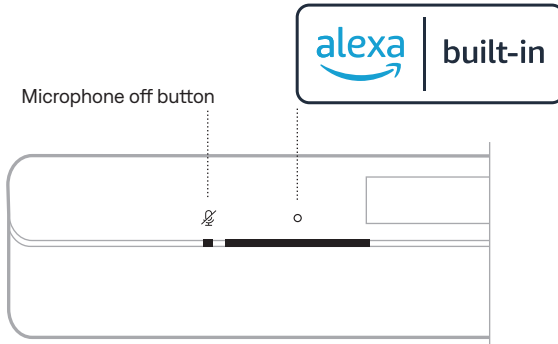

THINGS TO TRY	EXAMPLES OF WHAT TO SAY
<b>Play on a specific speaker</b>	Play jazz in the "Kitchen." <b>NOTE:</b> Make sure you say the speaker name you assigned in the Bose app. If multiple speakers have the same name, use the name assigned in the Alexa app or change the name in the Bose app.
<b>Set a timer</b>	Set a timer for 15 minutes.
<b>Discover more skills</b>	Help me get started with skills.
<b>Stop Alexa</b>	Stop.

### Use the soundbar controls

You can use the Action button  to control Amazon Alexa. You use the Microphone off button  to turn the microphone off. They are located on the top of the soundbar.



THINGS TO TRY	WHAT TO DO
<b>Talk to Alexa</b>	Tap  then say your request. For a list of things to try, visit: <a href="https://www.amazon.com/usealexa">https://www.amazon.com/usealexa</a>
<b>Stop alarms and timers</b>	Tap  .

THINGS TO TRY	WHAT TO DO
Stop Alexa	Tap  .
Turn the microphone on/off	Tap  . <b>NOTE:</b> When the microphone is off, the Microphone off light glows solid red, and you can't access Alexa.

## CALLING AND MESSAGING WITH AMAZON ALEXA

Help your household and family stay better connected. Let Alexa turn your device into an intercom to open up instant two-way conversations between rooms or homes, or send one-way announcements from any room. Use Alexa to call or message almost anyone for free on your supported Alexa device or the Alexa app on your supported mobile phone or tablet.

### NOTES:

- Both parties must have an Alexa-enabled device, the Alexa Calling and Messaging feature available and enabled, and given permission to the other party in the Alexa app.
- The microphone must be on to use Alexa calling and messaging (see page 39).

### Set up Alexa Calling and Messaging

To set up Alexa Calling and Messaging, use the Alexa app.

### Use your voice

Start with "Alexa," then say:

THINGS TO TRY	EXAMPLES OF WHAT TO SAY
Drop in on a device in your home	Drop in on "Kitchen." <b>NOTE:</b> If the device is a Bose product, make sure you say the speaker name you assigned in the Bose app. If multiple speakers have the same name, use the name assigned in the Alexa app or change the name in the Bose app.
Drop in on a family member or friend outside your home	Drop in on "Mom's Kitchen." <b>NOTE:</b> Make sure you say the speaker name assigned in the owner's Bose app and/or Alexa app.

THINGS TO TRY	EXAMPLES OF WHAT TO SAY
<b>Make a call</b>	Call Mom.
<b>Answer a call</b>	Answer.
<b>Decline a call or message</b>	Decline.
<b>End a call</b>	End call.
<b>Play a message</b>	Play message.
<b>Call an emergency contact</b>	Call my emergency contact.
<b>Make an announcement</b>	Announce that dinner is ready.

## SET UP DO NOT DISTURB

You can temporarily disable all incoming notifications, announcements, and calls to the soundbar.

### Use your voice

Start with "Alexa," then say:

THINGS TO TRY	EXAMPLES OF WHAT TO SAY
<b>Enable Do Not Disturb</b>	Turn on Do Not Disturb.
<b>Disable Do Not Disturb</b>	Turn off Do Not Disturb.

**TIP:** You can also set up Do Not Disturb using the Alexa app.

## CONTROL AUDIO WITH BOSE VOICE4VIDEO

Bose Voice4Video technology expands your Amazon Alexa voice capabilities like no other soundbar can. In addition to controlling your smart soundbar, you can control your TV and cable or satellite box with just your voice. With one simple ask of Alexa, you can turn on your TV and smart soundbar, switch to your video source, tune to a station by network name or channel number, and start watching your favorite shows instantly.

**NOTE:** Voice4Video is only available for TV, cable, and satellite boxes.

### Set up Voice4Video

To set up Voice4Video, use the Bose app.

**NOTE:** Before setting up Voice4Video, you must set up Alexa in the Bose app (see page 26).

### Use your voice

Start with "Alexa," then say:

THINGS TO TRY	EXAMPLES OF WHAT TO SAY
Power on TV	Turn on TV.
Power off TV	Turn off TV.
Play video	Play.
Pause video	Pause.
Resume video	Resume.
Skip video forward	Next.
Skip video backward	Previous.
Switch input to <i>Bluetooth</i> audio	Switch to <i>Bluetooth</i> .
Switch input to HDMI TV input	Switch to HDMI2.

THINGS TO TRY	EXAMPLES OF WHAT TO SAY
<b>Watch a specific network</b>	Watch NFL Network.
<b>Watch a specific channel number</b>	Watch channel 802.
<b>Skip to the next channel</b>	Next channel.
<b>Skip backward to the previous channel</b>	Previous channel.

## ACCESS GOOGLE ASSISTANT

The soundbar is compatible with a Google Assistant-enabled device connected to your network. Control the soundbar using just your voice with help from Google.

Start with saying “Hey Google,” then say your request on <soundbar name>. For example, try playing your favorite music. Just say “Hey Google, play My Workout playlist on Family Room.”

### NOTES:

- Voice control is disabled by default. To set up voice control, use the Bose app to enable Google Cast and set up voice casting for your Google Assistant-enabled device. You can access these options from the Settings menu.
- Make sure you say the soundbar name you assigned in the Bose app. If multiple soundbars have the same name, use the name assigned in the Google Assistant app or change the name in the Bose app.
- Google Assistant isn't available in all languages and countries.
- For more information on what Google Assistant can do, visit: <https://support.google.com/assistant>

The soundbar works with Google Cast. With Google Cast, you can stream audio from supported apps by simply tapping the Cast button.

**NOTES:**

- To use Google Cast, you must have a Wi-Fi connection.
- Google Cast is disabled by default. In the Bose app, use the Settings menu to enable Google Cast.
- Support for new apps is added periodically.

**Your phone is your remote**

- Simply tap the Cast button from apps you already know and love. No new logins or downloads required.
- Use your phone to search, play, pause, and turn up the volume from anywhere in the home.
- While you're streaming, you can keep using your phone for other things – scroll through social media, send a text, and even accept calls.
- Enjoy music throughout your house when you use multi-room casting with Cast-compatible speakers.

**Unlimited entertainment, all on your schedule**

Choose from millions of songs from popular music services like Pandora, Spotify, and Tunes.

The soundbar is capable of playing AirPlay 2 audio, which allows you to quickly stream audio from your Apple device to the soundbar or multiple speakers.

**NOTES:**

- To use AirPlay 2, you need an Apple device running iOS 11.4 or later.
- Your Apple device and soundbar must be connected to the same Wi-Fi network.
- For more information about AirPlay, visit: <https://www.apple.com/airplay>

**STREAM AUDIO FROM THE CONTROL CENTER**

1. On your Apple device, open the Control Center.
2. Tap and hold the audio card in the top-right corner of the screen, then tap the AirPlay icon .
3. Select your soundbar.

**STREAM AUDIO FROM AN APP**

1. Open a music app (like Apple Music), and select a track to play.
2. Tap .
3. Select your soundbar.

## CONNECT A DEVICE

1. On the remote, press the *Bluetooth* button .



The light bar pulses blue.

2. On your device, turn on the *Bluetooth* feature.

**NOTE:** The *Bluetooth* menu is usually found in the Settings menu.

3. Select your soundbar from the device list.

**NOTE:** Look for the name you entered for your soundbar in the Bose app. If you didn't name your soundbar, the default name appears.

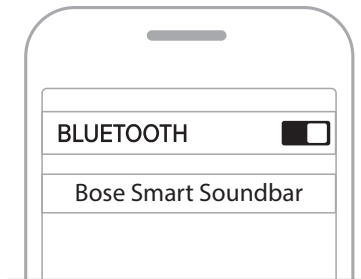

Once connected, you hear a tone, and the light bar glows solid white then fades to black. The soundbar's name appears in the device list.

## DISCONNECT A DEVICE

Use the Bose app to disconnect your device.

**TIP:** You can also use *Bluetooth* settings on your device. Disabling the *Bluetooth* feature disconnects all other devices.

## RECONNECT A DEVICE

On the remote, press the *Bluetooth* button ✕.

The soundbar tries to connect with the most recently-connected devices.

### NOTES:

- Make sure the *Bluetooth* feature is enabled on your device.
- The device must be within 30 ft (9 m) and powered on.

## CONNECT AN ADDITIONAL DEVICE

You can store up to eight devices in the soundbar device list.

**NOTE:** You can play audio from only one device at a time.

1. On the remote, press and hold ✕ until the light bar pulses blue.
2. On your device, select your soundbar from the device list.

**NOTE:** Make sure the *Bluetooth* feature is enabled on your device.

## CLEAR THE SOUNDBAR DEVICE LIST

1. On the remote, press and hold ✕ for 10 seconds until the light bar pulses white twice then fades to black.

The light bar pulses blue.

2. Delete the soundbar from the *Bluetooth* list on your device.

All devices are cleared, and the soundbar is ready to connect (see page 35).

The LED light bar located on the front of the soundbar shows the soundbar status.

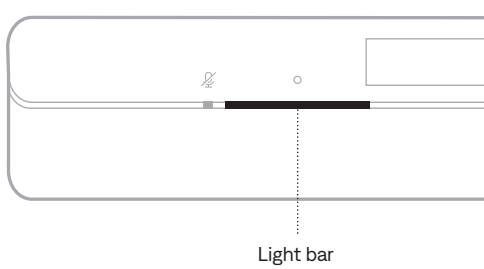

**NOTE:** The light bar displays one status at a time of the selected source.

## WI-FI STATUS

Shows the Wi-Fi connection status of the soundbar.

LIGHT BAR ACTIVITY		SYSTEM STATE
Pulsing white		Connecting to Wi-Fi
Solid white then fades to black		Connected to Wi-Fi









## BLUETOOTH STATUS

Shows the *Bluetooth* connection status of devices.

LIGHT BAR ACTIVITY		SYSTEM STATE
Pulsing blue		Ready to connect to device
Pulsing white		Connecting to device
Solid white then fades to black		Connected to device
White light pulses twice then fades to black		Clearing device list

## AMAZON ALEXA STATUS

Shows the status of Amazon Alexa.

LIGHT BAR ACTIVITY		SYSTEM STATE
Off		Amazon Alexa is idle
White light slides to the center then glows solid		Amazon Alexa is listening
White light slides to the sides		Amazon Alexa is thinking
Pulsing white (full)		Amazon Alexa is speaking
Pulsing yellow		Notification from Amazon Alexa
Solid white then white light slides to the sides		Alert from Amazon Alexa
Pulsing green		Receiving or making call
Solid green		Connected to call <b>NOTE:</b> When the call is disconnected, the light bar fades to black.
Solid purple then fades to black		Do Not Disturb is enabled <b>NOTE:</b> When Do Not Disturb is enabled, the light bar pulses purple each time you try to interact with Alexa.

## Microphone off light

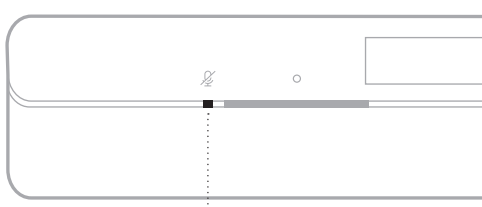

Microphone off light

### LIGHT ACTIVITY

### SYSTEM STATE

Solid red

The microphone is off

## MEDIA PLAYBACK AND VOLUME STATUS

Shows the soundbar status when controlling media playback and volume.

### LIGHT BAR ACTIVITY

### SYSTEM STATE

Two center lights glow solid white

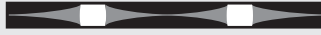

Pause

Right end of the light bar pulses white



Volume up

Left end of the light bar pulses white

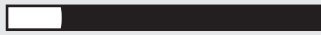

Volume down





Left end of the light bar glows solid white





Mute

## UPDATE AND ERROR STATUS

Shows the status of software updates and error alerts.

LIGHT BAR ACTIVITY		SYSTEM STATE
Solid amber		Wi-Fi setup in progress
White light slides from right to left		Downloading update
White light slides from left to right		Updating soundbar
Pulses red 4 times		Request is temporarily unavailable - try again later
Solid red		Error - contact Bose customer service

## DISABLE/ENABLE WI-FI CAPABILITY

On the remote, press and hold the Mute button  and *Bluetooth* button  until the light bar pulses white twice then fades to black.



## CONNECT ACCESSORIES (OPTIONAL)

You can connect any of these accessories to your soundbar. For more information, refer to your accessory owner's guide.

- **Bose Bass Module 700:** [Bose.com/BM700](https://www.bose.com/BM700)
- **Bose Bass Module 500:** [Bose.com/BM500](https://www.bose.com/BM500)
- **Bose Surround Speakers 700:** [Bose.com/SS700](https://www.bose.com/SS700)
- **Bose Surround Speakers:** [Bose.com/SS](https://www.bose.com/SS)

## CONNECT A BOSE SOUNDLINK *BLUETOOTH* SPEAKER OR BOSE HEADPHONES USING SIMPLESYNC TECHNOLOGY

With Bose SimpleSync technology, you can connect certain Bose SoundLink *Bluetooth* speakers or Bose headphones to the soundbar for a new way to hear your music and movies.

### Benefits

- **A personal TV listening experience:** Listen to TV without disturbing others by connecting your Bose headphones to the soundbar. Use independent volume controls on each product to lower or mute the soundbar while keeping your headphones as loud as you like.
- **Another room of audio:** Listen to the same song in two different rooms at the same time by connecting your Bose SoundLink *Bluetooth* speaker to the soundbar.
- **An added layer of immersion:** Access Personal Surround and add a new dimension to your movies and TV by connecting your Bose Ultra Open Earbuds to the soundbar (see page 45).

**NOTE:** SimpleSync technology has a *Bluetooth* range of up to 30 ft (9 m). Walls and construction materials can affect reception.

### Compatible products

You can connect most Bose SoundLink *Bluetooth* speakers to the soundbar, as well as Bose headphones.

Popular compatible products include:

- Bose SoundLink Max Portable Speaker
- Bose SoundLink Flex *Bluetooth* Speaker
- Bose SoundLink Micro *Bluetooth* speaker
- Bose SoundLink Revolve+ *Bluetooth* speaker
- Bose Ultra Open Earbuds
- Bose QuietComfort Ultra Headphones
- Bose QuietComfort Ultra Earbuds
- Bose QuietComfort 45 headphones

New products are added periodically. For a complete list and more information, visit: [support.bose.com/Groups](https://support.bose.com/Groups)

## Connect using the Bose app

To connect your Bose SoundLink *Bluetooth* speaker or Bose headphones to the soundbar, use the Bose app. For more information, visit: [support.bose.com/Groups](https://support.bose.com/Groups)

### NOTES:

- Make sure that the product you're connecting is powered on, within 30 ft (9 m) of the soundbar, and ready to connect to another device. For more information, refer to your product owner's guide.
- You can connect only one product at a time to the soundbar.

## RECONNECT A BOSE SOUNDLINK *BLUETOOTH* SPEAKER OR BOSE HEADPHONES

Use the Bose app to reconnect the soundbar to a previously-connected compatible Bose product.

**NOTE:** The soundbar must be within range (30 ft or 9 m) and powered on.

## ACCESS PERSONAL SURROUND WITH BOSE ULTRA OPEN EARBUDS

If you connect your Bose Ultra Open Earbuds to the soundbar, you can add another layer of immersion to your movies and TV with Personal Surround.

### Benefits

- Make your favorite content even more spacious and immersive. The earbuds enhance your soundbar audio by playing a mix of center, height, and surround audio channels along with it, like individual surround speakers.
- Customize audio settings for your preferences. Increase the center channel level for greater dialogue clarity, or increase the height and surround channel level for more immersion.

**NOTE:** Personal Surround works on content from all sources from the soundbar.

### Disable Personal Surround

Personal Surround is enabled by default when you connect your Bose Ultra Open Earbuds to the soundbar. You can disable Personal Surround if you want to independently control the earbud and soundbar volume or play all audio channels from both products.

To disable Personal Surround, use the Bose app. You can access this option from the main screen.

### Adjust Personal Surround audio settings

To adjust the earbud volume, center channel level, or height and surround channel level relative to the soundbar, use the Bose app. To access these options, on the main screen, tap ●●● on the volume slider for the group.

### Immersive Audio and shortcuts while Personal Surround is enabled

If you connect your Bose Ultra Open Earbuds to the soundbar while Personal Surround is enabled, Immersive Audio is temporarily set to Off and your shortcuts are temporarily disabled on both earbuds.

Once you disconnect your earbuds from the soundbar or disable Personal Surround, Immersive Audio returns to its previous setting and your shortcuts are re-enabled.

## UPDATE THE SOUNDBAR

After you complete the setup process in the Bose app and connect the soundbar to your Wi-Fi network, the soundbar updates automatically.

## REPLACE THE REMOTE BATTERY

### ⚠ WARNING

- **INGESTION HAZARD:** This product contains a button cell or coin battery.
- **DEATH** or serious injury can occur if ingested.
- A swallowed button cell or coin battery can cause **Internal Chemical Burns** in as little as **2 hours**.
- **KEEP** new and used batteries **OUT OF REACH** of **CHILDREN**
- **Seek immediate medical attention** if a battery is suspected to be swallowed or inserted inside any part of the body.



**NOTE:** For more information, see “WARNINGS/CAUTIONS” on page 2.

1. Using a coin, turn the battery compartment cover left (counter-clockwise) and remove the cover.

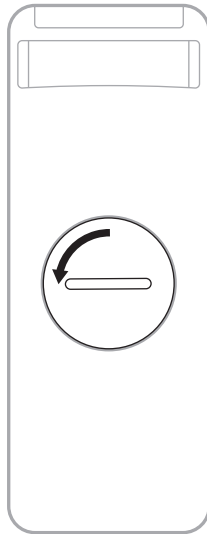

2. Insert the new battery flat side up, with the + symbol facing up.

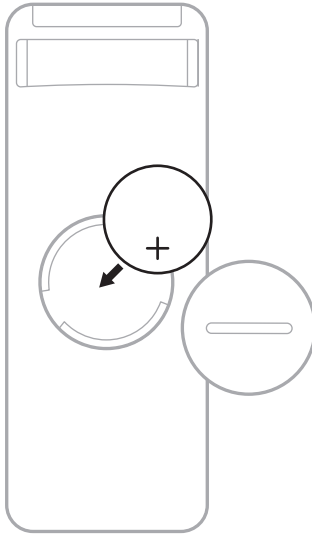

**NOTE:** Use only an agency approved (e.g., UL) CR2032 or DL2032 3-volt lithium battery.

3. Reset the cover and turn it right (clockwise) to lock in place.

## CLEAN THE SOUNDBAR

Wipe the outside surfaces of the soundbar with a soft, dry cloth.

### CAUTIONS:

- Do NOT allow liquids to spill onto the soundbar or into any openings.
- Do NOT blow air into the up-firing speakers or soundbar.
- Do NOT use a vacuum to clean the up-firing speakers or soundbar.
- Do NOT use any sprays near the up-firing speakers or soundbar.
- Do NOT use any solvents, chemicals, or cleaning solutions containing alcohol, ammonia, or abrasives.
- Do NOT allow objects to drop into any openings.

## REPLACEMENT PARTS AND ACCESSORIES

Replacement parts and accessories can be ordered through Bose customer service.

Visit: [support.Bose.com/bssb](https://support.Bose.com/bssb)

## LIMITED WARRANTY

The soundbar is covered by a limited warranty. Visit our website at [worldwide.Bose.com/Warranty](https://worldwide.Bose.com/Warranty) for details of the limited warranty.

To register your product, visit [worldwide.Bose.com/ProductRegistration](https://worldwide.Bose.com/ProductRegistration) for instructions. Failure to register will not affect your limited warranty rights.

## TRY THESE SOLUTIONS FIRST

If you experience problems with the soundbar:

- Make sure the soundbar is connected to a live AC (mains) outlet.
- Secure all cables.
- Check the state of the soundbar (see page 37).
- Download the Bose app, complete the setup process, and wait for any available software updates to download to the soundbar.
- Place the soundbar according to the placement guidelines (see page 15).
- Move the soundbar within the recommended range of your device for proper operation.
- Make sure the soundbar is at least 1 – 3 ft (0.3 – 0.9 m) away from wireless equipment.
- Check that any Wi-Fi access points are placed up to 8 – 10 ft (2.4 – 3.0 m) away from the soundbar, optional bass module, and optional surround speakers.



## OTHER SOLUTIONS

If you could not resolve your issue, see the table below to identify symptoms and solutions to common problems. You can also access troubleshooting articles, videos, and other resources at: [support.bose.com/bssb](https://support.bose.com/bssb)

If you are unable to resolve your issue, contact Bose customer service.

Visit: [worldwide.bose.com/contact](https://worldwide.bose.com/contact)

SYMPTOM	SOLUTION
<b>No HDMI eARC port on your TV</b>	Use your TV's HDMI ARC port. If your TV doesn't have an HDMI ARC port, use the optical cable to connect the soundbar to your TV.
<b>No HDMI eARC, HDMI ARC, or optical port on your TV</b>	If your TV is connected to a cable or satellite box, connect the optical cable from the soundbar to the cable or satellite box. Connect to your TV using an audio converter and separate audio cable, such as a coaxial, 3.5 mm or analog audio cable (not provided). The type of converter and cable you need depends on the audio output ports available on your TV.

SYMPTOM	SOLUTION
<b>Soundbar doesn't power on</b>	<p>Plug the power cord into a different AC (mains) outlet.</p> <p>Use the remote control to power on the soundbar (see page 21).</p> <p>Unplug the power cords for the soundbar and optional bass module or surround speakers, wait 30 seconds, and plug them firmly into a live AC (mains) outlet.</p>
<b>Soundbar doesn't power off</b>	<p>The soundbar may be in network standby mode. On the remote, press the Power button  to wake the soundbar. Press  again to power off the soundbar.</p>
<b>Audio isn't playing in Dolby Atmos</b>	<p>Make sure the soundbar is connected to your TV's HDMI eARC or ARC port.</p> <p>Check the Bose app Now Playing screen to make sure the audio is streaming in Dolby Atmos. If it's not streaming in Dolby Atmos, make sure the advanced audio settings of your TV are allowing Dolby Atmos to pass through to the soundbar. Refer to your TV owner's guide.</p>
<b>Remote is inconsistent or doesn't work</b>	<p>Replace the battery (see page 46).</p> <p>Make sure the remote is within operating range (20 ft or 6 m) of the soundbar.</p> <p>Make sure there are no obstructions between the remote and the soundbar.</p>
<b>Bose app doesn't work on device</b>	<p>Make sure your device is compatible with the Bose app and meets minimum system requirements. For more information, refer to the app store on your device.</p> <p>Uninstall the Bose app on your device then reinstall the app (see page 19).</p>
<b>Soundbar isn't visible to add to another Bose account</b>	<p>Make sure sharing is enabled on your soundbar using the Bose app.</p> <p>Make sure the soundbar and your device are connected to the same Wi-Fi network.</p>
<b>Soundbar and source don't power on/off simultaneously</b>	<p>Press the Power button  to power on/off the source.</p> <p>If the soundbar is connected to your TV's optical port, enable auto-wake so the soundbar powers on whenever a sound signal is received (see page 22).</p>

SYMPTOM	SOLUTION
<p><b>Intermittent or no audio from soundbar</b></p>	<p>Increase the volume on the soundbar (see page 24) or your device.</p> <p>If the left end of the light bar is glowing solid white, the soundbar is muted. Press the Mute button  to unmute the soundbar.</p> <p>Check the TV audio settings. Refer to your TV owner's guide.</p> <p>Make sure your device isn't muted.</p> <p>Make sure you're using a compatible <i>Bluetooth</i> device.</p> <p>Restart your device.</p> <p>Restart your audio source.</p> <p>Switch to a different source (see page 23).</p> <p>Play audio from a different application or music service.</p> <p>If the audio is from a Wi-Fi source, reset the router.</p> <p>Restart your TV.</p> <p>Update the TV software. Refer to your TV owner's guide.</p> <p>Disconnect the HDMI cable from your TV's HDMI eARC (or ARC) port and reconnect it.</p> <p>Make sure that the soundbar's HDMI cable is inserted into a port on your TV labeled <b>HDMI eARC</b> (Enhanced Audio Return Channel), not a standard HDMI port. If your TV doesn't have an HDMI eARC port, connect to the <b>HDMI ARC</b> port. If your TV doesn't have an ARC port, connect to the soundbar using the optical cable (see page 60).</p> <p>If the soundbar is connected to your TV's HDMI eARC (or ARC) port, make sure that <b>Consumer Electronics Control (CEC)</b> is enabled in your TV system menu. Your TV may refer to CEC by a different name. Refer to your TV owner's guide.</p> <p>If the soundbar is connected to your TV's optical port, make sure the optical cable is inserted into a port on your TV labeled <b>Output or OUT</b>, not Input or IN.</p> <p>Unplug the power cords for the soundbar and optional bass module or surround speakers, wait 30 seconds, and plug them firmly into a live AC (mains) outlet.</p> <p>Check the Advanced CEC setting in the Bose app. You can access this option from the Settings menu. For more information, visit: <a href="https://support.Bose.com/bssb_cec">support.Bose.com/bssb_cec</a></p>
<p><b>Soundbar doesn't connect to bass module or surround speakers</b></p>	<p>Refer to your bass module or surround speakers owner's guide for troubleshooting (see page 42).</p> <p>Make sure your bass module or surround speakers are compatible with the soundbar (see page 42).</p> <p>Unplug the power cords for the soundbar and optional bass module or surround speakers, wait 30 seconds, and firmly plug them into the AC (mains) outlet.</p>

SYMPTOM	SOLUTION
<p><b>No audio from bass module or surround speakers</b></p>	<p>Make sure your bass module or surround speakers are compatible with the soundbar (see page 42).</p> <p>Make sure the software is current in the Bose app.</p> <p>Adjust the bass level using the Bose app (see page 25).</p> <p>Switch to a different source (see page 23).</p>
<p><b>Sound is coming from TV speaker</b></p>	<p>Make sure that the soundbar's HDMI cable is inserted into a port on your TV labeled <b>HDMI eARC</b> (Enhanced Audio Return Channel), not a standard HDMI port. If your TV doesn't have an HDMI eARC port, connect to the <b>HDMI ARC</b> port. If your TV doesn't have an ARC port, connect to the soundbar using the optical cable (see page 60).</p> <p>Turn off your TV speakers. Refer to your TV owner's guide.</p> <p>Disconnect the HDMI cable from your TV's HDMI eARC (or ARC) port and reconnect it.</p> <p>Unplug the power cords for the soundbar and optional bass module or surround speakers, wait 30 seconds, and firmly plug them into the AC (mains) outlet.</p> <p>Decrease your TV volume to its lowest setting.</p> <p>If the soundbar is connected to your TV's HDMI eARC (or ARC) port, make sure that <b>Consumer Electronics Control (CEC)</b> is enabled in your TV system menu. Your TV may refer to CEC by a different name. Refer to your TV owner's guide.</p> <p>Check the Advanced CEC setting in the Bose app. You can access this option from the Settings menu. For more information, visit: <a href="https://support.Bose.com/bssb_cec">support.Bose.com/bssb_cec</a></p>
<p><b>Poor or distorted audio</b></p>	<p>Test different sources if available.</p> <p>Make sure that your TV can output surround sound audio. Refer to your TV owner's guide.</p> <p>If the audio is being played from another device, reduce the volume of that device.</p> <p>Adjust the bass level using the Bose app (see page 25).</p> <p>Power off your TV speakers. Refer to your TV owner's guide.</p> <p>Check for sound (see page 61).</p>

SYMPTOM	SOLUTION
<p><b>Soundbar doesn't play audio from the correct source or selects the incorrect source after a delay</b></p>	<p>Check the Advanced CEC setting in the Bose app. You can access this option from the Settings menu. For more information, visit: <a href="https://support.Bose.com/bssb_cec">support.Bose.com/bssb_cec</a></p> <p>Disable CEC on your source. Refer to the source owner's guide.</p>
<p><b>Soundbar doesn't connect to Wi-Fi network</b></p>	<p>In the Bose app, select the correct network name, and enter the network password (case-sensitive).</p> <p>Make sure the soundbar and your device are connected to the same Wi-Fi network.</p> <p>If your network information has changed, see page 20.</p> <p>Enable Wi-Fi on the device you are using for setup.</p> <p>Close other open applications on your device.</p> <p>Restart your device and router.</p> <p>If your router supports both 2.4 GHz and 5G Hz bands, make sure both the device (mobile or computer) and soundbar are connecting to the same band.</p> <p><b>NOTE:</b> Give each band a unique name to make sure you're connecting to the correct band.</p> <p>Reset the router.</p> <p>Unplug the power cords for the soundbar and optional bass module or surround speakers, wait 30 seconds, and firmly plug them into the AC (mains) outlet. Uninstall the Bose app on your device, reinstall the app, and restart setup.</p> <p>If connecting to a different network and the app doesn't prompt you for setup, go to the main screen and add the soundbar.</p>
<p><b>Soundbar doesn't connect with Bluetooth device</b></p>	<p>On your device, turn the <i>Bluetooth</i> feature off and then on. Delete the soundbar from the <i>Bluetooth</i> list. Connect again (see page 35).</p> <p>Connect a different device (see page 35).</p> <p>Make sure you're using a compatible <i>Bluetooth</i> device. Visit: <a href="https://support.Bose.com/bssb_bt">support.Bose.com/bssb_bt</a></p> <p>Delete the soundbar from your device <i>Bluetooth</i> list. Connect again (see page 35).</p> <p>Clear the soundbar device list (see page 36). Connect again (see page 35).</p>

SYMPTOM	SOLUTION
<b>Soundbar doesn't stream audio using AirPlay</b>	<p>Make sure your soundbar is powered on and in range (see page 22).</p> <p>Make sure your Apple device and your soundbar are connected to the same Wi-Fi network.</p> <p>Update your Apple device.</p> <p>Make sure the soundbar is up-to-date (see page 46).</p> <p>If you can't find the AirPlay icon  in the music app you are streaming from, stream audio from the Control Center.</p> <p>For additional support, visit: <a href="https://www.apple.com/airplay">https://www.apple.com/airplay</a></p>
<b>Alexa doesn't respond</b>	<p>Make sure the Microphone off light isn't glowing red. To turn on the microphone, see page 27.</p> <p>Make sure Alexa has been set up using the Bose app (see page 26).</p> <p><b>NOTE:</b> The soundbar must be set up and connected to your Wi-Fi network using the Bose app.</p> <p>Connect your device to Wi-Fi.</p> <p>Make sure you're in a country where Amazon Alexa is available.</p> <p>Make sure you are using the most up-to-date version of the Alexa app.</p> <p>Make sure your device is compatible.</p> <p>Make sure the wake word is enabled (see page 26).</p> <p>Remove Alexa from the soundbar using the Bose app. Add Alexa again.</p> <p>Make sure you say the name you assigned in the Bose app. If multiple soundbars have the same name, use the name assigned in the Alexa app or change the name in the Bose app.</p> <p>If using Bose Voice4Video:</p> <ul style="list-style-type: none"> <li>• Make sure there are no obstructions between the soundbar, your TV, and/or cable or satellite box.</li> <li>• Make sure the soundbar is connected using the HDMI cable (see page 59).</li> <li>• Make sure you have set up this feature using the Bose app and connected your TV and/or cable or satellite box.</li> <li>• Make sure you have entered your postal code and service provider for your cable/satellite box.</li> </ul> <p>Alexa may not support your request. New features are added periodically.</p> <p>For additional support, visit: <a href="https://www.amazon.com/usealexa">https://www.amazon.com/usealexa</a></p>

SYMPTOM	SOLUTION
<p><b>Google Assistant can't control the soundbar</b></p>	<p>Make sure you have a Google Assistant-enabled device connected to your network (see page 32).</p> <p>Make sure Google Cast is enabled in the Bose app (see page 32).</p> <p>Connect your device to Wi-Fi.</p> <p>Make sure you're in a country where Google Assistant is available.</p> <p>Make sure you are using the most up-to-date version of the Google Assistant app.</p> <p>Make sure your device is compatible.</p> <p>For additional support, visit: <a href="https://support.google.com/assistant">https://support.google.com/assistant</a></p>
<p><b>Soundbar doesn't connect to a Bose SoundLink Bluetooth speaker or Bose headphones</b></p>	<p>Make sure that your speaker or headphones are powered on, within 30 ft (9 m) of the soundbar, and ready to connect to another device. For more information, refer to your product owner's guide.</p>
<p><b>Soundbar doesn't reconnect to previously-connected Bose SoundLink Bluetooth speaker or Bose headphones</b></p>	<p>Connect using the Bose app (see page 19).</p>
<p><b>Poor audio quality from a connected Bose SoundLink Bluetooth speaker or Bose headphones</b></p>	<p>If your router supports both 2.4 GHz and 5 GHz bands, and the soundbar is connected to a 2.4 GHz frequency, connect to the 5 GHz frequency.</p> <p>Not all Bose SoundLink <i>Bluetooth</i> speakers can play audio in perfect sync when connected to the soundbar. To check if your product is compatible, visit: <a href="https://support.bose.com/Groups">support.bose.com/Groups</a></p> <p>Make sure Sync with Group is enabled in the Bose app (see page 19). You can access this option from the Settings menu.</p> <p>Install any available software updates for your speaker or headphones. To check for updates, open the appropriate Bose app for your product on your device or visit <a href="https://btu.bose.com">btu.bose.com</a> on your computer.</p>

SYMPTOM	SOLUTION
<b>Poor volume or audio balance from your connected Bose Ultra Open Earbuds when Personal Surround is enabled</b>	You can adjust the earbud volume, center channel level, or height and surround channel level relative to the soundbar using the Bose app. To access these options, on the main screen, tap ●●● on the volume slider for the group.
<b>Can't access shortcuts on your connected Bose Ultra Open Earbuds</b>	By default, Personal Surround is enabled when you connect your Bose Ultra Open Earbuds to the soundbar (see page 45). Your shortcuts are disabled on both earbuds while Personal Surround is enabled. To access your shortcuts, disable Personal Surround using the Bose app. You can access this option from the main screen.

## RESTORE THE SOUNDBAR

Restoring the factory settings clears all source, volume, and network settings from the soundbar and returns the soundbar to its default settings.

1. On the remote, press and hold the Volume down button — and Play/Pause button ▶|| for 5 seconds until the light bar pulses white twice then fades to black.



The soundbar reboots. When the reset is complete, the light bar glows solid amber.

2. To restore the soundbar's network and audio settings, launch the Bose app on your device and add the soundbar to your network (see "Add the soundbar to an existing account" on page 20).

## CONNECTION OPTIONS

Connect the soundbar to your TV using one of the following connection options:

- **Option 1 (preferred):** HDMI eARC (Enhanced Audio Return Channel) or ARC
- **Option 2:** Optical

### NOTES:

- To deliver the Dolby Atmos surround-sound experience, connect the soundbar to the HDMI eARC or ARC port on your TV (see page 59). If your TV doesn't have an eARC or ARC port, you can connect the optical cable to the optical port to receive spacious and life-like sound (see page 60).
- To use your TV remote to control the power, volume, and mute functions of the soundbar, the soundbar must be connected to the HDMI eARC or ARC port on your TV.

1. On the back of your TV, locate the **HDMI IN** and **Audio OUT** (optical) ports.

**NOTE:** Your TV port panel may not appear as shown. Look for the shape of the port.

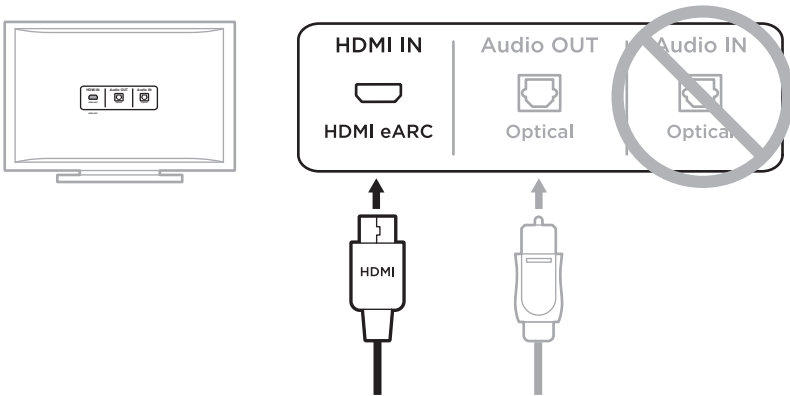

**Option 1 (Preferred)**  
**HDMI eARC (or ARC):** Use the HDMI cable for this connection.

**Option 2**  
**Optical:** If your TV doesn't have an HDMI eARC (or ARC) port, use the optical cable for this connection.

2. Choose an audio cable.

## CONNECT THE SOUNDBAR TO YOUR TV

After choosing an audio cable, connect the soundbar to your TV.

### Option 1 (preferred): HDMI eARC or ARC

1. Insert one end of the HDMI cable into your TV's **HDMI eARC** or **ARC** port.
2. Insert the other end of the cable into the **HDMI (eARC)** port on the soundbar.

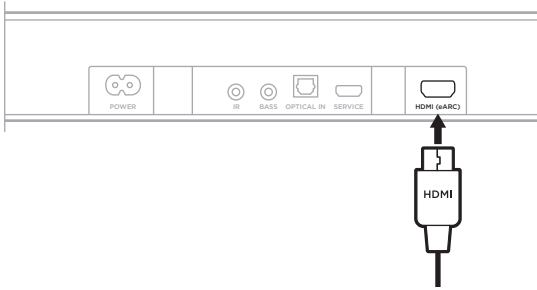

## Option 2: Optical

If your TV doesn't have an HDMI eARC (or ARC) port, use the optical cable to connect the soundbar to your TV.

1. Remove the protective cap from both ends of the optical cable.

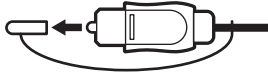

**CAUTION:** Inserting the plug with the cap attached can damage the plug and/or the port.

2. Insert one end of the optical cable into your TV's **Optical OUT** port.

**CAUTION:** Inserting the plug with the wrong orientation can damage the plug and/or the port.

3. Hold the plug at the other end of the optical cable.
4. Align the plug with the soundbar's **OPTICAL IN** port, and insert the plug carefully.

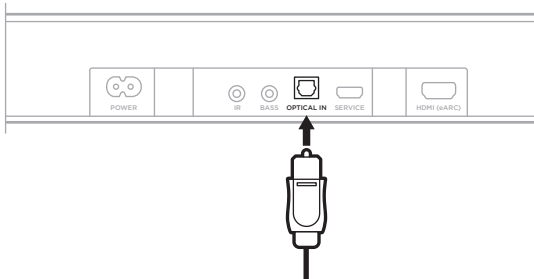

**NOTE:** The port has a hinged door that swings inward when inserting the plug.

5. Firmly push the plug into the port until you hear or feel a click.



## ROKU TV READY™

The Bose Smart Soundbar is Roku TV Ready certified. Connect the Bose Smart Soundbar to the **HDMI eARC** or **ARC** port on a Roku TV using an HDMI cable, then follow the on-screen setup instructions. Once completed, control the soundbar with your Roku TV remote and access the soundbar settings using the on-screen Roku TV settings menu.

### NOTES:

- The Bose Smart Soundbar may require a software update to support Roku TV Ready. For more information, contact Bose customer service.  
Visit: [support.Bose.com/bssb](https://support.Bose.com/bssb)
- Roku TV Ready isn't available in all regions. For more information, visit: [go.roku.com/roktvready](https://go.roku.com/roktvready)

## CHECK FOR SOUND

1. Power on your TV using your TV remote.
2. In the audio section of your TV's menu, turn off your TV speakers.

**NOTE:** Refer to your TV owner's guide for more information.

3. If you are using a cable/satellite box or other secondary source:
  - a. Power on this source.
  - b. Select the appropriate TV input.

4. Power on the soundbar (see page 22).

You hear sound coming from the soundbar.

5. On the soundbar remote, press the Mute button .

You don't hear sound coming from the TV speakers or soundbar.

**NOTE:** If you hear sound coming from your TV after your soundbar is muted, see "Sound is coming from TV speaker" on page 52.



AM892389-0010