

Tefal[®]

ActiFry[®] 2 in 1



www.actifry.co.uk

N

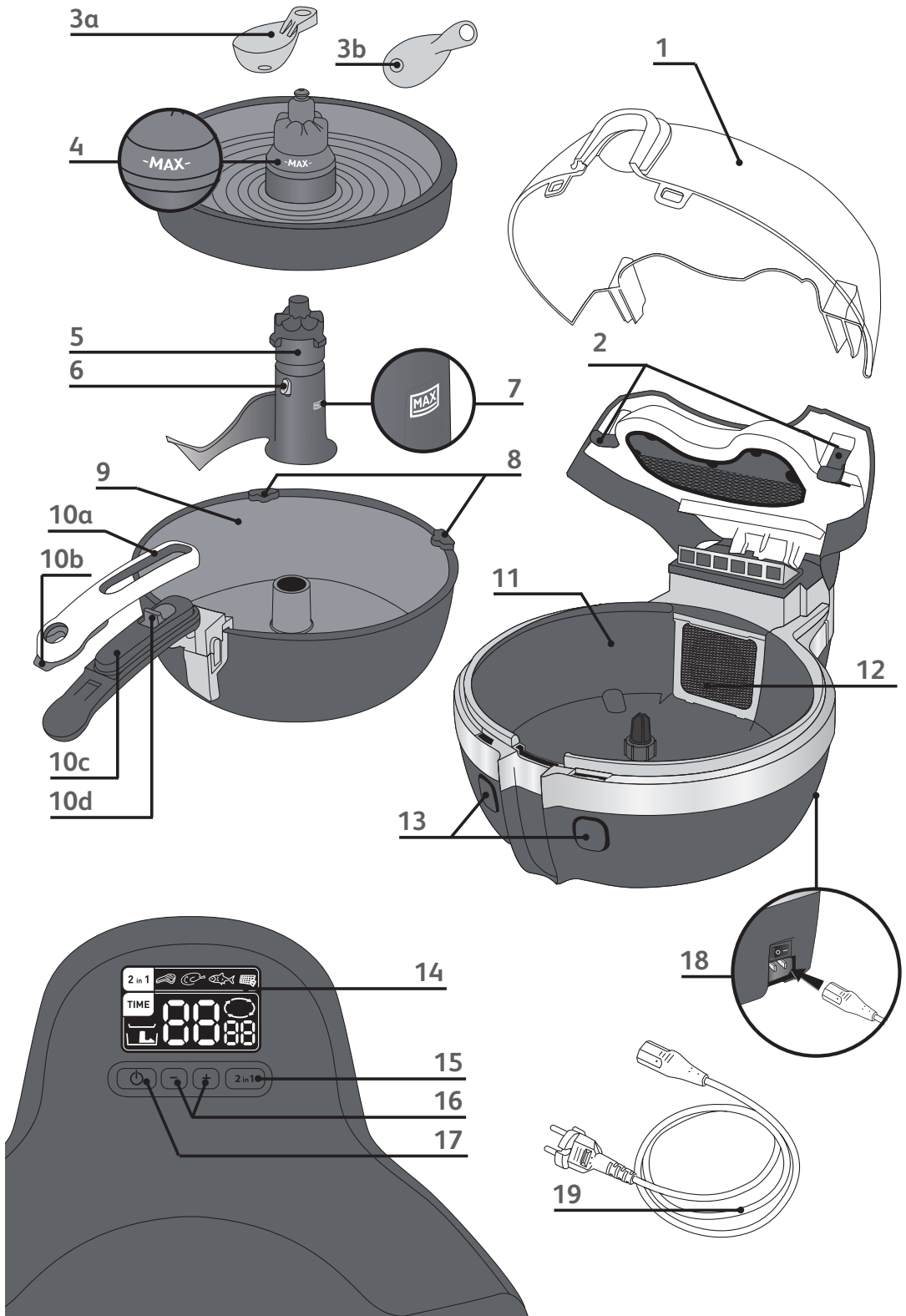

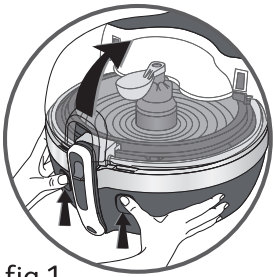

fig.1

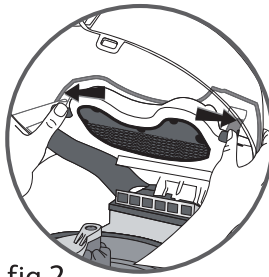

fig.2

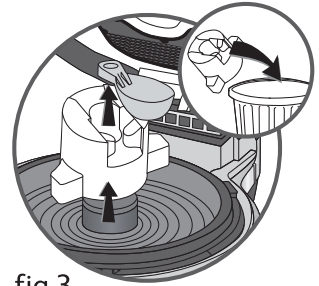

fig.3

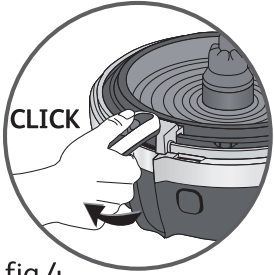

fig.4

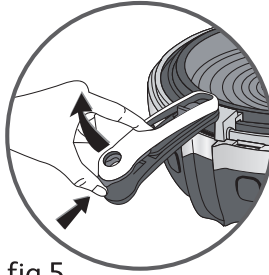

fig.5



fig.6



fig.7

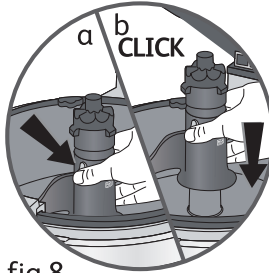

fig.8



fig.9

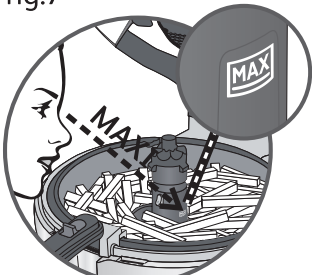

fig.10

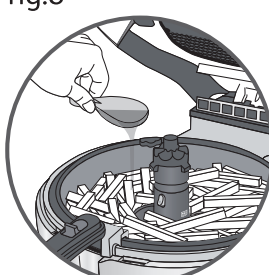

fig.11



fig.12

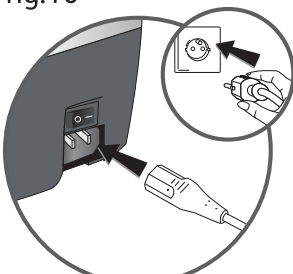

fig.13

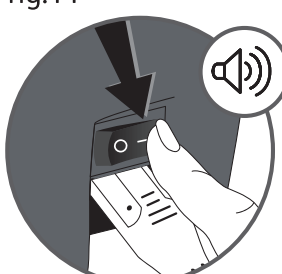

fig.14

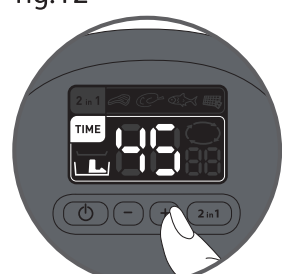

fig.15



fig.16



fig.17

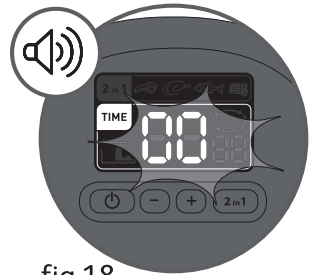

fig.18

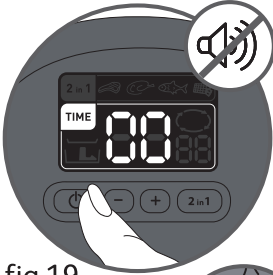

fig.19

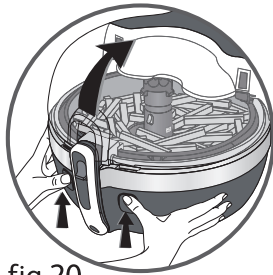

fig.20



fig.21

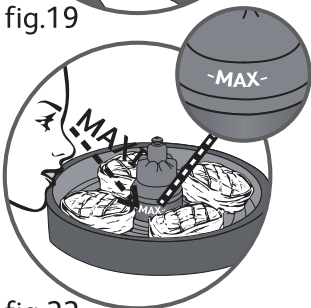

fig.22



fig.23

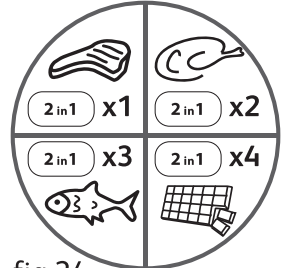

fig.24

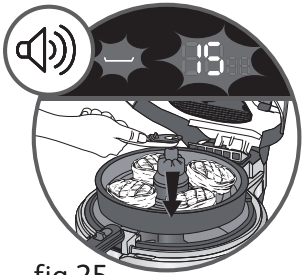

fig.25



fig.26



fig.27

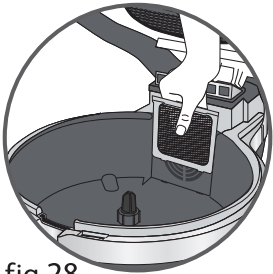

fig.28

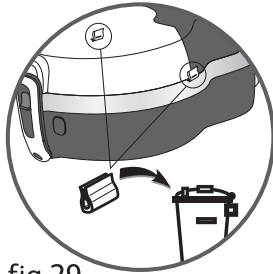

fig.29



fig.30



Tefal

Nutritious & Delicious

Innovating for your health

Nutrition is of course all about having a varied and balanced diet... but it's also more than that. The way we cook our food plays a vital role in its taste, texture and the nutritional value. Also because not all appliances are the same, **Tefal** has developed a range dedicated to NUTRITION FOR ADDED PLEASURE: ingenious kitchenware designed to safeguard the nutritional value whilst bringing out the real taste of the ingredients.

Combining the pleasure of good food with nutritional value: that's what the Nutritious and Delicious range is all about.

For Tefal, inventing **ActiFry® 2 in 1**, is about breaking new ground with a versatile appliance that can be used for practical eating to provide variety for everybody, every day.

Providing you with unique solutions

Tefal is investing in research to develop appliances which offer unrivalled nutritional performances, backed by scientific studies.

Keeping you informed

Tefal has always been the preferred choice for enjoyable, fast and practical ways of cooking your meals.

Day after day, the Nutritious and Delicious range from **Tefal** will help you share the pleasure of cooking using a balanced choice of foods, by:

- developing and preserving the qualities of the natural ingredients which are essential in your food,
- limiting the use of fats,
- encouraging a return to the tastes and flavours that we tend to have forgotten,
- keeping the time you spend preparing a meal to a minimum.

Within this range of products, **ActiFry® 2 in 1** allows you to cook your main course and side dish with a small amount of oil and salt.

Welcome to the world of ActiFry® 2 in 1!

Here's how you can make your very own delicious meal.

It's our patented technology which makes the chips crisp and fluffy. You choose the ingredients, the oil, spices, herbs and seasoning... **ActiFry® 2 in 1** will take care of the rest.

Only 3 %* fat: 1 spoonful of oil is all you need!

One spoonful of oil of your choice is all you need to make 1.5 kg of real chips. The **ActiFry® 2 in 1** spoon has a salt measure on the underside which helps you to reduce the amount of salt you use without compromising on taste.

* 1.5 kg of fresh potato chips, cut into chips with a cross section 13 mm x 13 mm, cooked until weight loss of -55 % with 20 ml of oil.

So much more than just ordinary steak and chips!

With **ActiFry® 2 in 1** you can cook a lot of different recipes. Put a bit of variety into your daily diet with some steak and chips, some tender stir-fry vegetables, delicious tasty minced meat, flavoursome prawns, fruits and more...



: the **ActiFry® 2 in 1**

Also included is a book of recipes prepared
by some top chefs and nutritionists.

It's full of original ideas on how to make delicious and nutritional main meals, along with side dishes to accompany them, as well as desserts you can create for the whole of the family.

So that you can get the best results from your cooking, Tefal offers you special advice on potatoes and oils.

The potato: for an enjoyable and balanced diet every day!

Potatoes are a great food for everybody at every age. They are an excellent source of energy and are rich in vitamins. Depending on the varieties, the climatic conditions and cultivation, the potato can vary greatly in terms of: shape, size, quality of taste. Each one has its own characteristics. In respect of earliness, yield, size, colour, storage quality and directions for cooking. The cooking results may vary depending on the origin and seasonality.

What variety should be used for ActiFry® 2 in 1?

In general, we advise that you use potato varieties that are recommended for making chips such as Maris Piper and King Edward. For newly harvested potatoes which have a high moisture content, we advise that you cook your chips for an extra few minutes.

With **ActiFry® 2 in 1** it's also possible to cook frozen chips. Because they are already pre-cooked, there is no need to add any oil.

Where should you store potatoes?

The best places to store potatoes are in a dark cellar, or a cool cupboard (between 6 and 8°C), away from any light.

How should potatoes be prepared for ActiFry® 2 in 1?

For best results, you must make sure that the chips do not stick together. For this we recommend you wash the peeled potatoes thoroughly before cutting them and then once again when they have been cut up, until the water has turned clear.

This will allow you to remove the maximum amount of starch. Carefully dry the chips using a dry and highly absorbent clean tea towel. The chips must be perfectly dry before they are put in the **ActiFry® 2 in 1**.

How should the potatoes be cut?

The chip's crispiness and fluffiness depends on its size. The more thinly cut your chips are, the crispier they will be and vice-versa, the thicker they are the fluffier they will be on the inside. Depending on your preference, you can vary the size of your chips and change the cooking time accordingly:

Thickness: Thin American style: 8 x 8 mm / Standard: 10 x 10 mm / Thick: 13 x 13 mm
Length up to 9 cm.

The maximum recommended chip thickness is 13 x 13 mm and a length of up to 9 cm.

Try using different oils which are good for you

If you fancy treating yourself to a different taste, then choosing one spoonful of a different oil is all you need. All the fatty acids which are essential for life can be found in vegetable oils. They all contain in different proportions, the nutrients which are essential for a balanced diet. It's important to vary the oils you use in order to provide your body with everything it needs! With **ActiFry® 2 in 1**, you can use a very large variety of oils:

- Standard oils: sunflower, olive, corn, rapeseed*, grapeseed, groundnut (peanut), soya*.
- Flavoured oils: oils infused with herbs, garlic, peppers, lemon...
- Speciality oils: hazelnut*, sesame*, safflower*, almond*, avocado*, argan* (cooking time varies according to the manufacturer).

***Note:** Some of these oils are not available in the UK.

The **ActiFry® 2 in 1** technology with its low quantity of fats, allows you to retain the good fatty acids which are essential for providing you with the energy you need.

With ActiFry® 2 in 1, you can treat yourself and your friends too!
To find out more or if you've any questions, please visit www.actifry.co.uk

Some helpful advice

- When using the appliance for the first time you may notice a harmless smell. This smell, which will not affect the appliance in any way, will quickly disappear.
- So as not to damage your appliance make sure you stick to the quantities of ingredients and liquid given in the instruction booklet and recipe book.
- Never overload the tray and do not exceed the recommended quantities.
- Never leave your 2in1 spoon in the appliance whilst it is on.
- Never place the tray in the appliance without the bowl.
- Never put the paddle in without the bowl.
- Never exceed the height indicated by the maximum level marker on the paddle and the maximum mark on the tray.
- Place the tray in the appliance when the reminder beep sounds and not at the beginning of cooking (except if the cooking time in the pan and the tray are the same).
- Never leave the appliance unattended whilst in operation.

Important recommendations

Safety instructions

- Read these instructions carefully and keep them in a safe place.
- This appliance is not intended to be operated using an external timer or separate remote control system.
- For your safety, this appliance conforms with applicable standards and regulations (Directives on Low Voltage, Electromagnetic Compatibility, Materials in contact with food, Environment, etc.).
- Check that the voltage of your mains network corresponds to the voltage given on the rating plate on the appliance (alternative current).
- Given that there are so many different standards, if the appliance is to be used in a country other than that in which it was bought, have it checked by Approved Service Centre.
- This appliance is intended to be used only in the household. It is not intended to be used in the following applications, and the guarantee will not apply for:
 - staff kitchen areas in shops, offices and other working environments;
 - farm houses inns,
 - clients in hotels, motels and other residential type environments,
 - bed and breakfast type environments.
- Do not use the appliance if it or the power cord is damaged or if it has fallen and has visible damage or appears to be working abnormally. If this occurs, the appliance must be sent to an Approved Service Centre.
- For models with detachable power cords, only use the original power cord.
- If the power cord is damaged, it must be replaced by the manufacturer, an approved After-Sales Service or a similarly qualified person, in order to avoid any danger. Never take the appliance apart yourself.
- This product has been designed for domestic use only. Any commercial use, inappropriate use or failure to comply with the instructions, the manufacturer accepts no responsibility and the guarantee will not apply.
- Do not use an extension lead. If you nevertheless decide to do so, under your own responsibility, use an extension lead that is in good condition and compliant with the power of the appliance.
- Use the appliance on a flat, stable, heat-resistant work surface away from water splashes.
- Do not let the power cord dangle.
- Do not unplug the appliance by pulling on the power cord.
- Always unplug your appliance: after use, to move it, or to clean it.
- This appliance is not designed to be used by people (including children) with a physical, sensory or mental impairment, or people without knowledge or experience, unless they are supervised or given

prior instructions concerning the use of the appliance by someone responsible for their safety. Children must be supervised to ensure that they do not play with the appliance.



- Certain parts of the appliance can become hot when the appliance is operating, which could cause burns. Do not touch the hot surfaces of the appliance (the lid, visible metal parts, etc).
- Never immerse your appliance in water!
- Please refer to the instructions booklet before cleaning or servicing your appliance.
- Do not use the instruction close to inflammable materials (blinds, curtains, etc), nor close to an external heat source (gas hob, hotplate, etc).
- In the event of fire, unplug the appliance and smother the flames using a damp tea towel.
- Never operate the appliance underneath kitchen cupboards.
- Never move the appliance when it still contains hot food.
- Never operate your appliance when empty.
- Never leave the appliance unattended whilst it is plugged in and switched on.

Protect the environment

- Your appliance has been designed to run for many years. However, when you decide to replace it, remember to think about how you can contribute to protecting the environment.
- Before discarding your appliance you should remove the battery from the timer and dispose of it at a local civic waste collection centre (according to model).
- The Approved Service Centres will take back any old appliances you may have so that they can be disposed of in accordance with environmental regulations.



Environment protection first!

- ① Your appliance contains valuable materials which can be recovered or recycled.
- ➔ Leave it at a local civic waste collection point.

Description

1. Transparent lid
2. Lid latches
3. 2in1 spoon (2in1)
 - a. oil side
 - min= 14 ml (4 people)
 - max= 20 ml (6 people)
 - b. salt side
4. 2in1 cooking tray with "MAX" level
5. Mixing paddle (detaches from bowl)
6. Paddle unlocking button
7. "MAX" liquid contents level
8. Tray support pads
9. Detachable bowl
10. 2in1 handle
 - a. tray handle
 - b. button for disconnecting the two handles
 - c. bowl handle
 - d. button for unlocking the bowl handle
11. Body
12. Detachable filter
13. Lid opening control
14. LCD screen
15. Button for activating the 2in1 function
16. + and – button for adjusting cooking time
17. Button for starting and stopping cooking
18. On/off switch switch and plug-in socket
19. Detachable power cord

For fast cooking

Before using for the first time

⚠ • Don't forget to remove the protective sleeves located on the lid before using the appliance – fig.29.

- Open the lid by pressing on the lid opening control buttons – fig.1 and push the two grey latches outwards to remove the lid – fig.2.
- Remove the 2in1 spoon and its polystyrene packing which you can then throw away – fig.3.
- Lift up the bowl's handle horizontally until you hear a "CLICK" sound – fig.4.
- Remove the tray handle by pushing on the button 10b – fig.5.
- You can use this handle for taking out the tray – fig.6-7.
- Turn over the tray handle and slide back the green clip, fit the tray handle onto the tray and slide back the clip fully to lock it – fig.6.
- Remove the paddle by pushing the unlocking button – fig.8a.
- Take the bowl out.
- Remove the detachable filter – fig.28.
- All these detachable parts are dishwasher safe – fig.9 or can be cleaned with a non-abrasive sponge and some washing-up liquid.
- Dry thoroughly before putting back.
- Adjust the position of the paddle until you hear a "CLICK" sound – fig.8b.

The inside of the ActiFry pan has a high resistance ceramic coating.

When using the appliance for the first time you may notice a harmless smell. This smell, which will not affect the appliance in any way, will quickly disappear.

Prepare the food EN

When using the bowl on its own, never place the tray in the appliance.



Do not use the paddle without the bowl.

Do not leave the measuring spoon inside the 2in1 while cooking the food.

- Open the lid – fig.1.
- Remove the 2in1 spoon – fig.3 and the tray – fig.7.
- Lift the handle up – fig.4 and remove the bowl from the appliance.
- Place your food in the bowl making sure you always keep to the quantities recommended in the cooking tables and/or the recipe book (please see: “Cooking table for bowl only”). Never exceed the “MAX” level marker – fig.10.
- Depending on the food, add the recommended amount of oil in the 2in1 spoon and pour the contents evenly in to the bowl – fig.11.
- Put the bowl back into the appliance and close the lid.
- Push the handle back – fig.12.

Using the bowl on its own

Start cooking

- Connect the detachable power cord to the appliance and plug it in – fig.13.
- Push the switch 0/I – fig.14, the appliance will make a beep sound and the screen displays 00.
- Adjust the cooking time using the buttons  – fig.15 (see “Cooking table”). The maximum cooking time that can be programmed is 60 minutes.
- Press the start button  – fig.16. The minute countdown starts. The countdown will only be displayed in seconds when there is less than a minute left.
- You can adjust the cooking time at any time by pressing on the buttons  – fig.17.

Opening the lid stops the cooking. You can start the cooking again by pressing on the start button  after it has been switched off.

Once the lid has been open for 2 minutes the appliance will go into stand-by mode.

Remove the food

- When the cooking is finished, the timer will sound and the screen will start flashing and displaying 00 – fig.18: the appliance automatically stops cooking your food. You can stop the buzzer by pressing on the start button  – fig.19.
- Open the lid – fig.20.
- Lift the handle up until you hear the “CLICK” sound – fig.21.
- Remove the bowl and take the food out.

Cooking tables for bowl only

The cooking times given are a guide only, they may vary depending on whether the food items are in season, their size, how well done you like your food and the electrical voltage used. The quantity of oil indicated may be increased in accordance with your tastes and needs. If you like your chips even more crispy, try cooking for a few extra minutes.

Potatoes

	TYPE	QUANTITY	OIL	COOKING TIME
Standard size chips 10 mm x 10 mm* (length up to 9 cm)	Fresh	1500 g**	1 spoonful of oil	41-43 min
		1250 g**	1 spoonful of oil	38-40 min
		1000 g**	¾ spoonful of oil	35-37 min
		750 g**	½ spoonful of oil	30-32 min
		500 g**	⅓ spoonful of oil	24-26 min
		250 g**	⅓ spoonful of oil	20-22 min
Straight cut frozen chips 10 mm x 10 mm***	Frozen	1200 g	without	36-38 min
		750 g	without	24-26 min

* For UK style thicker chips cut 13 mm x 13 mm increase the cooking time slightly.

** Weight of unpeeled potatoes.

*** For American Style Thin Cut Frozen Chips (8 mm x 8 mm) cook for the same time as 10 mm x 10 mm frozen chips.

Other vegetables

	TYPE	QUANTITY	OIL	COOKING TIME
Courgettes	Fresh in slices	1200 g	1 spoonful of oil + 150 ml cold water	30 min
Peppers	Fresh in slices	1000 g	1 spoonful of oil + 250 ml cold water	25 min
Mushrooms	Fresh in quarters	1000 g	1 spoonful of oil	20 min
Tomatoes	Fresh in quarters	1000 g	1 spoonful of oil	20 min
Onions	Fresh in round slices	750 g	1 spoonful of oil	30 min

Meats - Poultry

To give extra taste to your meat, feel free to mix the spices in the oil (paprika, curry, basil, thyme, oregano, cumin...).

	TYPE	QUANTITY	OIL	COOKING TIME
Chicken nuggets	Fresh	1200 g	without	18-20 min
	Frozen	1200 g	without	18-20 min
Chicken drumsticks	Fresh	9	without	25-30 min
Chicken legs	Fresh	3	without	30-35 min
Chicken breast (boneless)	Fresh	9 small chicken breasts (about 1200 g)	without	22-25 min
Spring rolls	Fresh	12 small	1 spoonful of oil	10-12 min
Pork chops	Fresh (2.5 cm thick)	6	1 spoonful of oil	18-20 min*
Pork fillet	Fresh (cut into thin slices or strips)	9	1 spoonful of oil	13-15 min
Minced beef	Fresh	900 g	1 spoonful of oil	13-15 min
	Frozen	600 g	1 spoonful of oil	13-15 min
Meatballs	Frozen	1200 g	1 spoonful of oil	18-20 min
Sausages (pork)	Fresh	8 – 10	without	10-12 min

Fish – Shellfish

	TYPE	QUANTITY	OIL	COOKING TIME
Battered calamari	Frozen	500 g	without	12-14 min
Prawns	Cooked	600 g	without	8-10 min
King prawns	Frozen and thawed	450 g	without	9-11 min

Desserts

	TYPE	QUANTITY	OIL	COOKING TIME
Bananas	in slices	700 g (7 bananas)	1 spoonful of oil + 1 spoonful of brown sugar	4-6 min
	in foil	3 bananas	without	15-17 min
Apples	cut in half	5	1 spoonful of oil + 2 spoonfuls of sugar	10-12 min
Pears	diced	1500 g	2 spoonfuls of sugar	10-12 min
Pineapple	diced	2	2 spoonfuls of sugar	15-17 min

Using the tray on its own

Get your food ready



- Open the lid – fig.1.
- Remove the 2in1 spoon – fig.3.
- Lift the handle up – fig.4 and remove the tray handle – fig.5.
- Fit the handle on the tray – fig.6.
- Remove the tray – fig.7.
- Place your food on the tray making sure you always keep to the quantities recommended in the cooking tables and/or the recipe book (please see “Cooking table for 2in1” for tray quantities). Never exceed the “MAX” level marker shown on the centre of the tray – fig.22.
- Put the tray back in the appliance
- Put the 2in1 handle back, then fold it away.
- Close the lid.

When using the tray on its own, do not put food into the bowl.

Start the cooking

Opening the lid stops the cooking. You can resume cooking by pressing on the start button after it has been switched off.

Once the lid has been open for 2 minutes the appliance will go into stand-by mode.



- Connect the detachable power cord to the appliance and plug it in – fig.13.
- Push the switch 0/I – fig.14, the appliance will make a beep sound and the screen displays 00.
- Adjust the cooking time using the button   (see “Cooking table”).
- Select the type of food you want to cook in the tray using the button  – fig.23 and 24.

 press once

 press twice

 press three times

 press four times (for desserts and fruit)

- Press the start button . The minute countdown starts. The countdown will only be displayed in seconds when there is less than a minute left.
- You can adjust the cooking time at any time by pressing on the buttons  .

Remove your food

- When the cooking is finished, the timer will sound and the screen will start flashing and displaying 00 -: the appliance automatically stops cooking your food. You can stop the buzzer by pressing on the start button  – fig.19.
- Open the lid.
- Clip the handle on to the tray – fig.26.
- Remove the tray.
- Serve your food.

Using the 2in1: bowl + tray







Get your food ready

- Open the lid – fig.1.
- Remove the 2in1 spoon and the tray – fig.3, 6 & 7.
- Lift the handle up - fig.4 and remove the bowl from the appliance
- Place your food in the bowl making sure you always keep to the quantities recommended in the cooking tables and/or the recipe book (please see “Cooking table for 2in1”). Never exceed the “MAX” level marker on the paddle – fig.10.
- Depending on the food, add the recommended amount of oil in the 2in1 spoon and pour the contents evenly in to the bowl – fig.11
- Put the bowl back in the appliance and close the lid.
- Fold away the handle – fig.12.

Start the 2in1 cooking

There is a pre-set time for each type of food which you can adjust.

When you are not using it, the appliance will automatically switch itself off after 10 minutes.

- Connect the detachable power cord to the appliance and plug it in – fig.13.
- Push the switch 0/I , the appliance will make a beep sound and the screen displays 00 – fig.14.
- Adjust the total cooking time (= time to cook food in the bowl) using the buttons   (see “Cooking table for 2in1”) – fig.15.
- Select the type of food you want to cook in the tray using the button  – fig.23 and 24.
- Adjust the cooking time for the tray using the buttons   (please see “Cooking table”).
- Push the start button . The cooking of the food in the bowl starts.
- The minute by minute countdown starts.
- While the food is cooking in the bowl, get the food ready for cooking on the tray. Make sure you don't exceed the maximum level mark on the tray – fig.22.
- When the appliance beeps and stops automatically, open the lid and put the tray in – fig.25.
- Close the lid again and press the start button .
- The countdown resumes.





Remove your food

- When the cooking is finished, the timer will sound and the screen will start flashing and displaying 00: the appliance automatically stops cooking your food. You can stop the buzzer by pressing on the start button  – fig.19.
- Open the lid – fig.20.
- Lift up the handle until you hear the “CLICK” – fig.21.
- Disconnect the two handles by pressing the button 10b.
- Turn over the tray handle and slide back the green clip, fit the tray handle onto the tray and slide back the clip fully to lock it – fig.26.
- Remove the tray and take your food out – fig.27.
- Remove the bowl and take your food out.

Be careful, because the tray is very hot after cooking. Always use the tray handle to remove it. If you want even crispier chips, you can cook them for a further 2 minutes after you've removed the tray.

Cooking table for 2in1

The cooking times given are a guide only, they may vary depending on the size of the food items and on how well done you like your food cooked. At the end of the 2in1 cooking time, if you like your chips or potatoes even more crispy cook them for an few extra minutes after you've removed the tray.

FOOD IN BOWL	QUANTITY IN BOWL	TOTAL TIME	2IN1 SETTING	TRAY QUANTITY	TRAY TIME
Fresh potato chips 10 mm x 10mm	1250 g	45 min	Beefburgers 	4	7 min
	1000 g	35 min		4	7 min
	750 g	30 min		3	6 min
	250 g	25 min		1	5 min
Courgettes in slices	1000 g	30 min	Salmon fillet 	4	10 min
	750 g	25 min		3	10 min
	500 g	20 min		2	8 min
	250 g	18 min		1	7 min
Fresh or frozen chips 10 mm x 10 mm	1250 g	50 min	Chicken drumsticks 	5	18 min
	1000 g	45 min		4	16 min
	750 g	40 min		3	16 min
	250 g	33 min		1	15 min
Figs cut in pieces	10	20 min	Filo chocolate parcels 	4	5 min

Easy to clean Clean the appliance

- Allow it to cool down completely.
- Open the lid by pressing on the buttons – fig.1 push the two latches outwards to remove the lid – fig.2.
- Lift the bowl's handle up horizontally until you hear a "CLICK" sound – fig.4.
- Remove the tray – fig.7.
- Remove the paddle by pressing on the unlocking button – fig.8a.
- Take the bowl out.
- Remove the detachable filter – fig.28.
- All these detachable parts are dishwasher safe – fig.9 or can be cleaned with a non-abrasive sponge and some washing-up liquid.
- Clean the inside and outside of the appliance with a slightly damp sponge.
- ⚠ • **If you're cooking any fatty food on the tray which may cause fat splashes we recommend that you clean the fat splashes off using a slightly damp sponge each time you've finished using your appliance. In particular clean the internal areas of the blower marked by black arrows – fig.30.**
- Dry thoroughly before putting back.

Never immerse the appliance in water.

Never use corrosive or abrasive cleaning substances.

The detachable filter must be cleaned regularly.

So as to keep your bowl and tray in the best possible condition, do not use any metallic utensils.

A few tips in case of problems...

PROBLEMS	CAUSES	SOLUTIONS
The appliance won't work.	The appliance isn't correctly plugged in.	Check that the appliance is correctly plugged in.
	You haven't yet pressed the ON / OFF button.	Press the ON / OFF button.
	You've pressed the ON / OFF button but the appliance won't work.	Close the lid.
	The appliance won't heat up.	Contact our customer service helpline (see below).
The paddle is not turning correctly.	The paddle is not turning correctly.	Check that the paddle is correctly in place and adjust until you hear a "CLICK" sound. If it still does not operate contact our Customer Relations helpline (see below).
	The paddle isn't locked.	Adjust the position of the paddle until you hear the "CLICK" sound - fig.8b .
The tray won't turn.	The tray isn't locked.	Adjust the position of the tray until you hear the "CLICK" sound.
The food is not cooked evenly.	You haven't used the paddle.	Put it in position.
	The food is not cut to the same size.	Cut all the food to the same size.
	The chips are not cut to the same size.	Cut all the chips to the same size.
	The paddle is in the right position but it won't turn.	Check that the paddle is correctly in place and adjust until you hear a "CLICK" sound. If it still does not operate contact our Customer Relations helpline (see below).
The chips are not crispy enough.	You are using a variety of potatoes unsuitable for chips.	Choose a variety of potato suitable for chips such as Maris Piper or King Edward for best results. Freshly harvested potatoes may have a high moisture content, either cook for a few minutes more or try using a different batch and/or variety of potatoes.
	The potatoes haven't been sufficiently washed and dried.	Wash, drain and dry the potatoes thoroughly before cooking.
	The chips are too thick.	Cut them more thinly.
	There's not enough oil.	Increase the quantity of oil (see "Cooking table").
The filter (12) is blocked.	Clean the filter.	
The food won't turn with the tray.	The food is too thick.	Reduce the thickness of your food.
The food in the bowl isn't cooked.	The tray was put on the bowl when the cooking started.	Only put the tray in during the second half of the cooking phase.
The chips become broken whilst they are being cooked.	You are using too large a quantity or the chips are too long.	Reduce the quantity of potatoes and/or do not cut chips longer than 9 cm in length.
The food remains on the edge of the bowl.	The bowl is overloaded.	Stick to the quantities indicated in the cooking table. Reduce the quantity of food.
	Maximum level exceeded.	Reduce the quantities.
Liquids from the cooking have seeped into the body of the appliance.	Bowl faulty.	Check that there aren't any leaks by filling the bowl up to the MAX level of the paddle. If you do find a leak, contact our customer service helpline (see below).
	The maximum level has been exceeded.	Don't go over the maximum level.
The LCD screen doesn't work anymore.	The appliance isn't plugged in.	Plug the appliance in.
	The appliance hasn't been turned on.	Press the ON / OFF button.
	The appliance has been used incorrectly and as a result has gone into safety mode.	Contact our customer service helpline (see below).
The LCD screen is indicating Err.	The appliance has a malfunction.	Unplug the appliance, wait 10 seconds, plug the appliance back in again, and press the ON/OFF button. If the LCD screen is still indicating Err, contact our customer service helpline (see below).
The appliance is making an abnormal amount of noise.	You suspect that the appliance's motors are not working properly.	Take the appliance to an Approved Service Centre.
During combined cooking, the machine won't stop for you to put the tray in.	Tray cooking has not been programmed.	Use the 2in1 function during combined cooking. Read the instructions again.
The cooking tray detaches from tray handle.	Tray handle attached incorrectly.	The green clip on the handle must be fully pushed back to ensure it is firmly clipped to the tray.

If you have any product problems or queries call our Customer Relations Team first for expert help and advice:

Helpline: 0845 602 1454 - UK

(01) 677 4003 - ROI

or contact us via our web site: www.tefal.co.uk



Environment protection first !

- ① Your appliance contains valuable materials which can be recovered or recycled.
- ➡ Leave it at a local civic waste collection point.

TEFAL / T-FAL*

INTERNATIONAL LIMITED GUARANTEE

 : www.tefal.com

*This product is **repairable** by TEFAL / T-FAL, during and after the **guarantee** period.*

The Guarantee

This product is guaranteed by TEFAL / T-FAL (company address and details included in the country list of the TEFAL / T-FAL International Guarantee) against any manufacturing defect in materials or workmanship during the guarantee period within those countries as stated in the Country List on the last page of the user manual, starting from the initial date of purchase.

The international manufacturer's guarantee by TEFAL / T-FAL is an extra benefit which does not affect consumer's Statutory Rights.

The international manufacturer's guarantee covers all costs related to restoring the proven defective product so that it conforms to its original specifications, through the repair or replacement of any defective part and the necessary labour. At TEFAL / T-FAL's choice, a replacement product may be provided instead of repairing a defective product. TEFAL / T-FAL's sole obligation and your exclusive resolution under this guarantee are limited to such repair or replacement.

Conditions & Exclusions

The international TEFAL / T-FAL guarantee only applies within the guarantee period and for those countries listed in the Country List attached and is valid only on presentation of a proof of purchase.

The product can be taken directly in person to an authorised service centre or must be adequately packaged and returned, by recorded delivery (or equivalent method of postage), to a TEFAL / T-FAL authorised service centre. Full address details for each country's authorised service centres are listed on TEFAL / T-FAL website (www.tefal.com) or by calling the appropriate telephone number as set out in the Country List to request the appropriate postal address.

TEFAL / T-FAL shall not be obliged to repair or replace any product which is not accompanied by a valid proof of purchase.

This guarantee will not cover any damage which could occur as a result of misuse, negligence, failure to follow TEFAL / T-FAL instructions, use on current or voltage other than as stamped on the product, or a modification or unauthorised repair of the product. It also does not cover normal wear and tear, maintenance or replacement of consumable parts, or the following:

- using the wrong type of water or consumable,
- scaling (any de-scaling must be carried out according to the instructions for use),
- ingress of water, dust or insects into the product,
- mechanical damages, overloading,
- damages or bad results due to wrong voltage or frequency,
- accidents including fire, flood, thunderbolt, etc.
- professional or commercial use,
- damage to any glass or porcelain ware in the product,
- replacement of consumables.

This guarantee does not apply to any product that has been tampered with, or to damages incurred through improper use and care, faulty packaging by the owner or mishandling by any carrier.

The international TEFAL / T-FAL guarantee applies only for products purchased in one of the countries listed, **and** used for domestic purposes only in one of the countries listed on the Country List. Where a product purchased in one listed country and then used in another listed country:

- a) The international TEFAL / T-FAL guarantee duration is the one in the country of usage of the product, even if the product was purchased in another listed country with different guarantee duration.

- b) The international TEFAL / T-FAL guarantee does not apply in case of non conformity of the purchased product with the local standards, such as voltage, frequency, power plugs, or other local technical specifications.
- c) The repair process for products purchased outside the country of use may require a longer time if the product is not locally sold by TEFAL / T-FAL.
- d) In cases where the product is not repairable in the new country, the international TEFAL / T-FAL guarantee is limited to a replacement by a similar product or an alternative product at similar cost, where possible.

Consumer Statutory Rights

This international TEFAL / T-FAL guarantee does not affect the statutory rights a consumer may have or those rights that cannot be excluded or limited, nor rights against the retailer from which the consumer purchased the product. This guarantee gives a consumer specific legal rights, and the consumer may also have other legal rights which vary from State to State or Country to Country. The consumer may assert any such rights at his sole discretion.

Additional information

Accessories, consumables and end-user replaceable parts can be purchased, if locally available, as described on the TEFAL / T-FAL internet site.

** TEFAL household appliances appear under the T-FAL brand in some territories like America and Japan. TEFAL/T-FAL are registered trademarks of Groupe SEB.*

TEFAL/T-FAL INTERNATIONAL GUARANTEE

Date of purchase: / Date d'achat / Fecha de compra / Data da compra / Data d'acquisto / Kaufdatum / Aankoopdatum / Købsdato / Inköpsdatum / Kjøpsdato / Ostopäivä / Data zakupu / Data vânzării / Įsigijimo data/ Ostukuupäev / Datum nakupa / Sorozatszám / Dátum nákupu / Pirkuma datums / Datum Kupovine / Datum kupnje / Data cumpărării / Datum nákupu / Tarikh pembelian / Tanggal pembelian / Ngày mua hàng / Satın alma tarihi / Дата продажи / Дата на закупуване / Датум на купување / Сатылған мөзгімі / Ημερομηνία αγοράς / Πωλητήριο οριζ / วันที่ยึด / 購買日期 / 購入日 / 구입일자 / تاريخ الشراء / تاريخ خريد / تاریخ خرید

Product reference: / Référence du produit / Referencia del producto / Nome do produto / Tipo de prodotto / Typnummer des Gerätes / Artikelnummer van het apparaat / Referencenummer / Produktreferens / Artikkelnnummer / Tuotenumero / referencja produktu / Model / Gaminio numeris / Toote viitenumber / Tip aparata / Vásárlás kelte / Typ výrobku / Produkta atsauces numurs / Model proizvoda / Oznaka proizvoda / Cod produs / Produkt rujukan / Referensi produk / Mã sản phẩm/ Ürün kodu / Модель / Модель / Модел на уреда / Модели / Κωδικός προϊόντος / Όηηηη / รุ่นผลิตภัณฑ / 產品模型 / 製品レファレンス番号 / 제품명 / مرجع محصول / مرجع المنتج

Retailer name & address: / Nom et adresse du vendeur / Nombre y dirección del minorista / Nome e endereço do revendedor / Nome e indirizzo del negozio / Name und Anschrift des Händlers / Naam en adres van de dealer / Forhandler navn & adresse / Återförsäljarens namn och adress / Forhandler navn og adresse / Jälleenmyyjän nimi ja osoite / nazwa i adres sprzedawcy / Numele și adresa vânzătorului / Parduotuvės pavadinimas ir adresas / Müüja kauplus ja aadress / Naziv in naslov trgovine / Tipusszám / Názov a adresa predajcu / Veikala nosaukums un adrese / Naziv i adresa maloprodaje / Naziv i adresa prodavca / Naziv i adresa prodajnog mjesta / Nume și adresă vânzător / Název a adresa prodejece / Nama dan alamat peruncit / Nama Toko Penjual dan alamat / Tên và địa chỉ cửa hàng bán/ Satıcı firmanın adı ve adresi / Название и адрес продавца / Назва і адреса продавця / Търговки обект / Назив и адреса на продавницата / Сатушының аты және мекен-жайы / Επωνυμία και διεύθυνση καταστήματος / Πωλητήριο οριζ / ชื่อและที่อยู่ของห้าง/ร้านที่ซื้อ / 零售商的店名和地址 / 販売店の名前、住所 / 소매점 이름과 주소 / وعنوانه / اسم بائع التجزئة وعنوانه / نام خرده فروش و آدرس / نام خرده فروشی و آدرس

Distributor stamp: / Cachet distributeur / Sello del distribuidor / Carimbo do revendedor / Timbro del negozio / Händlerstempel / Stempel van de dealer / Forhandler stempel / Återförsäljarens stämpel / Forhandler stempel / Jälleenmyyjän leima / pieczęć sprzedawcy / Ştampila vânzătorului / Antspaudas / Tempel / Žig trgovine / Eladó neve, címe/ Razítko predajcu / Zimogs / Pečat maloprodaje/ Pečat prodavca / Pečat prodajnog mjesta / Ştampila vânzătorului/ Razítko prodejece/ Cap peruncit / Cap dari Toko Penjual / Cửa hàng bán đóng dấu/ Satıcı Firmanın Kaşesi / Печать продавца / Печатка продавця / Печат на търговския обект / Печат на продавницата / Сатушының мөрі / Σφραγίδα καταστήματος / Πωλητήριο οριζ / 印章 / 零售商的蓋印 / 販売店印 / 소매점 직인 / مهر خرده فروشی / ختم بائع التجزئة

INTERNATIONAL GUARANTEE : COUNTRY LIST

			
الجزائر ALGERIA	CIJA 9 rue Puvis de Chavannes Saint Euquene Oran	1 an 1 year	(0)41 28 18 53
ARGENTINA	GRUPE SEB ARGENTINA S.A. Billinghurst 1833 3° C1425DTK Capital Federal Buenos Aires	2 años 2 years	0800-122-2732
ՀԱՅԱՍՏԱՆ ARMENIA	ՓԲԸ «Գրուպա ՍԵԲ», 125171, Մոսկվա, Լենինգրադյան խնուղի, 16A, շին.3	2 տարի 2 years	(010) 55-76-07
AUSTRALIA	GRUPE SEB AUSTRALIA PO Box 7535, Silverwater NSW 2128	1 year	02 97487944
ÖSTERREICH AUSTRIA	SEB ÖSTERREICH HmbH Campus 21 - Businesspark Wien Süd Liebermannstr. A02 702 2345 Brunn am Gebirge	2 Jahre 2 years	01 866 70 299 00
BELGIQUE BELGIE BELGIUM	GRUPE SEB BELGIUM SA NV 25 avenue de l'Espérance - ZI 6220 Fleurus	2 ans 2 years	070 23 31 59
БЕЛАРУСЬ BELARUS	ЗАО «Группа СЕБ-Восток», 125171, Москва, Ленинградское шоссе, д. 16А, стр. 3	2 года 2 years	017 2239290
BOSNA I HERCEGOVINA	SEB Développement Predstavništvo u BiH Vrazova 8/II 71000 Sarajevo	2 godine 2 years	Info-linija za potrošače 033 551 220
BRASIL BRAZIL	SEB DO BRASIL PRODUTOS DOMÉSTICOS LTDA Avenida Arno, 146 Mooca 03108-900 São Paulo SP	1 ano 1 year	0800-119933
БЪЛГАРИЯ BULGARIA	ГРУП СЕБ БЪЛГАРИЯ ЕООД Ул. Борово 52 Г, ет. 1, офис 1, 1680 София	2 години 2 years	0700 10 330
CANADA	GRUPE SEB CANADA 345 Passmore Avenue Toronto, ON M1V 3N8	1 an 1 year	800-418-3325
CHILE	GRUPE SEB CHILE Comercial Ltda Av. Providencia, 2331, piso 5, oficina 501 Santiago	2 años 2 years	12300 209207
COLOMBIA	GRUPE SEB COLOMBIA Apartado Aereo 172, Kilometro 1 Via Zipaquirá Cajica Cundinamarca	2 años 2 years	18000919288

HRVATSKA CROATIA	SEB Developpement S.A.S. Vodnjanska 26 10000 Zagreb	2 godine 2 years	01 30 15 294
ČESKÁ REPUBLIK CZECH REPUBLIC	GROUPE SEB ČR spol. s r. o. Jankovcova 1569/2c 170 00 Praha 7	2 roky 2 years	731 010 111
DANMARK DENMARK	GROUPE SEB NORDIC AS Tempovej 27 2750 Ballerup	2 år 2 years	44 663 155
DEUTSCHLAND GERMANY	GROUPE SEB DEUTSCHLAND GmbH / KRUPS GmbH Herrrainweg 5 63067 Offenbach	2 Jahre 2 years	0212 387 400
EESTI ESTONIA	GROUPE SEB POLSKA Sp. z o.o. ul. Bukowińska 22b 02-703 Warszawa	2 aastat 2 years	5 800 3777
SUOMI FINLAND	Groupe SEB Finland Kutojantie 7 02630 Espoo	2 Vuotta 2 years	09 622 94 20
FRANCE Incluant uniquement Guadeloupe, Martinique, Réunion, Saint-Martin	GROUPE SEB FRANCE Service Consommateur Moulinex BP 15 69131 ECULLY CEDEX	1 an 1 year	09 74 50 47 74
ΕΛΛΑΔΑ GREECE	SEB GROUPE ΕΛΛΑΔΟΣ Α.Ε. Οδός Καβαλιεράτου 7 Τ.Κ. 145 64 Ν. Κηφισιά	2 χρόνια 2 years	2106371251
香港 HONG KONG	SEB ASIA Ltd. Room 903, 9/F, South Block, Skyway House 3 Sham Mong Road, Tai Kok Tsui, Kowloon Hong-Kong	1 year	852 8130 8998
MAGYARORSZÁG HUNGARY	GROUPE SEB CENTRAL-EUROPE Kft. Táviró köz 4 2040 Budaörs	2 év 2 years	06 1 801 8434
INDONESIA	GROUPE SEB INDONESIA (Representative office) Sudirman Plaza, Plaza Marein 8th Floor JL Jendral Sudirman Kav 76-78, Jakarta 12910, Indonesia	1 year	+62 21 5793 6881
ITALIA ITALY	GROUPE SEB ITALIA S.p.A. Via Montefeltro, 4 20156 Milano	2 anni 2 years	199207354
JAPAN	GROUPE SEB JAPAN Co. Ltd. 1F Takanawa Muse Building, 3-14-13, Higashi Gotanda, Shinagawa-Ku, Tokyo 141-0022	1 year	0570-077772
ҚАЗАҚСТАН KAZAKHSTAN	ЖАҚ «Группа СЕБ- Восток» 125171, Москва, Ленинградское шоссе, 16А, 3 үйі	2 жыл 2 years	727 378 39 39
한국어 KOREA	(유)그룹 세브 코리아 서울시 종로구 서린동 88 서린빌딩 3층 110-790	1 year	1588-1588

LATVIA LATVIA	GRUPE SEB POLSKA Sp. z o.o. ul. Bukowińska 22b 02-703 Warszawa	2 gadi 2 years	6 716 2007
LIETUVA LITHUANIA	GRUPE SEB POLSKA Sp. z o.o. ul. Bukowińska 22b 02-703 Warszawa	2 metai 2 years	6 470 8888
LUXEMBOURG	GRUPE SEB BELGIUM SA NV 25 avenue de l'Espérance - ZI 6220 Fleurus	2 ans 2 years	0032 70 23 31 59
MACEDONIA	Groupe SEB Bulgaria EOOD Office 1, floor 1, 52G Borovo St., 1680 Sofia - Bulgaria ГРУП СЕБ БЪЛГАРИЯ ДООЕЛ Ул. Борово 52 Г, сп. 1, офис 1, 1680 София, България	2 години 2 years	(0)2 2050 022
MALAYSIA	Unit No.402-403, Level 4, Uptown 2, No.2, Jalan SS21/37, Damansara Uptown, 47400 Petaling Jaya, Selangor D.E., Malaysia.	1 year	(603) 7710 8000
MEXICO	Groupe.S.E.B. México, S.A. DE C.V. Goldsmith 38 Desp. 401, Col. Polanco Delegación Miguel Hildalgo 11 560 México D.F.	1 año 1 year	(01800) 112 8325
MOLDOVA	ТОВ «Груп СЕБ Україна» 02121, Харківське шосе, 201-203, 3 поверх, Київ, Україна	2 ani 2 years	(22) 929249
NEDERLAND The Netherlands	GRUPE SEB NEDERLAND BV Generatorstraat 6 3903 LJ Veenendaal	2 jaar 2 years	0318 58 24 24
NEW ZEALAND	GRUPE SEB NEW ZEALAND Unit E, Building 3, 195 Main Highway, Ellerslie, Auckland	1 year	0800 700 711
NORGE NORWAY	GRUPE SEB NORDIC AS Tempovej 27 2750 Ballerup DANMARK	2 år 2 years	815 09 567
PERU	Groupe SEB Perú Av. Camino Real N° 111 of. 805 B San Isidro - Lima - Perú	1 año 1 year	441 4455
POLSKA POLAND	GRUPE SEB POLSKA Sp. z o.o. ul. Bukowińska 22b 02-703 Warszawa	2 lata 2 years	0801 300 423 koszt jak za połączenie lokalne
PORTUGAL	GRUPE SEB IBÉRICA SA Urb. da Matinha Rua Projectada à Rua 3 Bloco1 - 3º B/D 1950 - 327 Lisboa	2 anos 2 years	808 284 735
REPUBLIC OF IRELAND	GRUPE SEB IRELAND Unit B3 Aerodrome Business Park, College Road, Rathcoole, Co. Dublin	1 year	01 677 4003
ROMÂNIA ROMANIA	GRUPE SEB ROMÂNIA Str. Daniel Constantin nr. 8 010632 București	2 ani 2 years	0 21 316 87 84
РОССИЯ RUSSIA	ЗАО «Группа СЕБ-Восток», 125171, Москва, Ленинградское шоссе, д. 16А, стр. 3	2 года 2 years	495 213 32 30

SRBIJA SERBIA	SEB Developpement Đorđa Stanojevića 11b 11070 Novi Beograd	2 godine 2 years	060 0 732 000
SINGAPORE	GROUPE SEB SINGAPORE Pty Ltd. 59 Jalan Pemipin, #04-01/02 L&Y Building Singapore 577218	1 year	65 6550 8900
SLOVENSKO SLOVAKIA	GROUPE SEB Slovensko, spol. s r.o. Rybničná 40 831 06 Bratislava	2 roky 2 years	233 595 224
SLOVENIJA SLOVENIA	SEB d.o.o Gregorčičeva ulica 6 2000 MARIBOR	2 leti 2 years	02 234 94 90
ESPAÑA SPAIN	GROUPE SEB IBÉRICA S.A. C/ Almogàvers, 119-123, Complejo Ecurban 08018 Barcelona	2 años 2 years	902 31 24 00
SVERIGE SWEDEN	TEFAL SVERIGE SUBSIDIARY OF GROUP SEB NORDIC Truckvägen 14 A, 194 52 Upplands Väsby	2 år 2 years	08 594 213 30
SUISSE CHWEIZ SWITZERLAND	GROUPE SEB SCHWEIZ GmbH Thurgauerstrasse 105 8152 Glattbrugg	2 ans 2 Jahre 2 years	044 837 18 40
TAIWAN	SEB ASIA Ltd. Taipei International Building, Suite B2, 6F-1, No. 216, Tun Hwa South Road, Sec. 2 Da-an District Taipei 106, R.O.C.	1 year	886-2-27333716
THAILAND	GROUPE SEB THAILAND 2034/66 Italthai Tower, 14th Floor, n° 14-02, New Phetchburi Road, Bangkapi, Huaykwang, Bangkok, 10320	2 years	662 351 8911
TÜRKIYE TURKEY	GROUPE SEB ISTANBUL AS Beybi Giz Plaza Dereboyu Cad. Meydan Sok. No: 28 K.12 Maslak	2 YIL 2 years	216 444 40 50
U.S.A.	GROUPE SEB USA 2121 Eden Road Millville, NJ 08332	1 year	800-395-8325
Україна UKRAINE	ТОВ «Груп СЕБ Україна» 02121, Харківське шосе, 201-203, 3 поверх, Київ, Україна	2 роки 2 years	044 492 06 59
UNITED KINGDOM	GROUPE SEB UK LTD Riverside House Riverside Walk Windsor Berkshire, SL4 1NA	1 year	0845 602 1454
VENEZUELA	GROUPE SEB VENEZUELA Av Eugenio Mendoza, Centro Letonia, Torre ING Bank, Piso 15, Ofc 155 Urb. La Castellana, Caracas	2 años 2 years	0800-7268724
VIETNAM	GROUPE SEB VIETNAM (Representative office) 127-129 Nguyen Hue Street District 1, Ho Chi Minh City, Vietnam	1 year	+84-8 3821 6395

 : www.tefal.com