

dyson v8

User manual

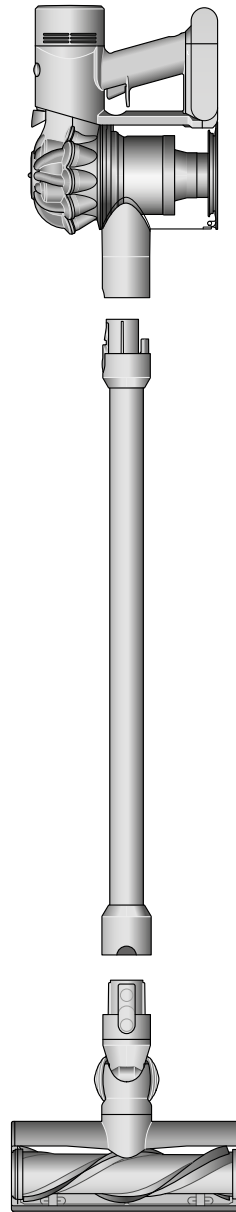

Contents

In the box

Getting started

Caring for your floors

Charging your machine

Emptying your bin

Cleaning your bin

Clearing blockages

Washing filter A

Washing filter B

Clearing obstructions from your

Motorbar™ cleaner head

Clearing blockages from your

Mini motorised tool

Washing your Fluffy™ cleaner head

brush bar

Cleaning your tools

Looking after your machine

In the box

Your machine will come with one or more of these cleaner heads – not all will be included.

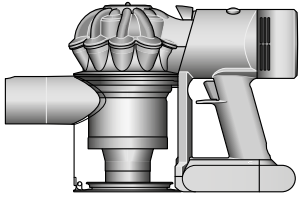

Vacuum cleaner

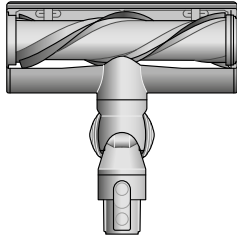

Motorbar™ cleaner head

De-tangling vanes automatically clear wrapped hair from the brush bar as you clean.

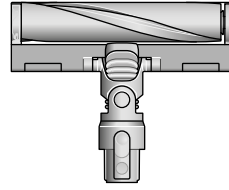

Fluffy™ cleaner head

Soft woven nylon removes large debris, while anti-static carbon fibre filaments extract fine dust from hard floors.

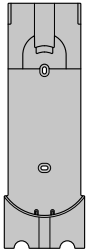

Wall dock

The Dyson cordless vacuum drops into the wall-mounted charging dock, ready for your next clean.



Charger

Charges your vacuum with or without a dock.



Wand

Some tools may not be included.

You can buy additional tools at www.dyson.co.uk



Combination tool

Two tools in one – wide nozzle and brush, for quick switching between cleaning and dusting tasks around your home or car.



Crevice tool

Engineered for precise cleaning around tricky edges and into hard-to-reach narrow spaces.

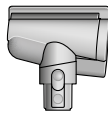

Hair screw tool

Anti-tangle conical brush bar spirals hair off and into the bin. Motor-driven cleaning for smaller spaces.

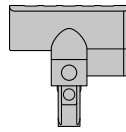

Mini motorised tool

Motorised brush bar, concentrated in a smaller head to remove stubborn dirt from mattresses, upholstery and stairs.



Low-reach adaptor

Bends to comfortably reach down low. Engineered to clean further under low furniture by adjusting the wand angle up to 90°.



Soft dusting brush

Enclosed in a skirt of soft nylon bristles for gentle, vacuum-assisted dusting of delicate objects and surfaces.



Stubborn dirt brush

Stiff nylon bristles dislodge ground-in dirt from coarse carpets, high traffic areas and car interiors.



Fabric and mattress tool

Removes dust, dirt and allergens from mattresses and upholstery.



Extension hose

Adds up to 61cm of flexible reach to any tool attachment, to clean up high or down low in your home or car.

Getting started

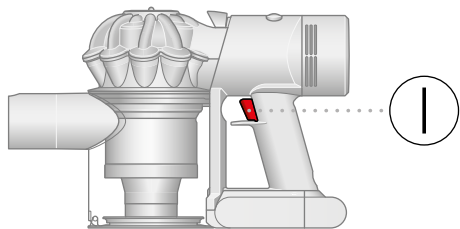

Pull trigger to start cleaning

Two power modes

Toggle between Powerful mode – for longer suction – and MAX mode, for stronger suction. Just hold down the trigger and slide the control back and forth.

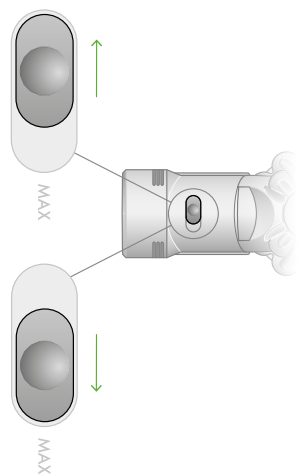

Switch accessories quickly

The quick-release tools click into place, and release in moments by simply depressing the release switch.

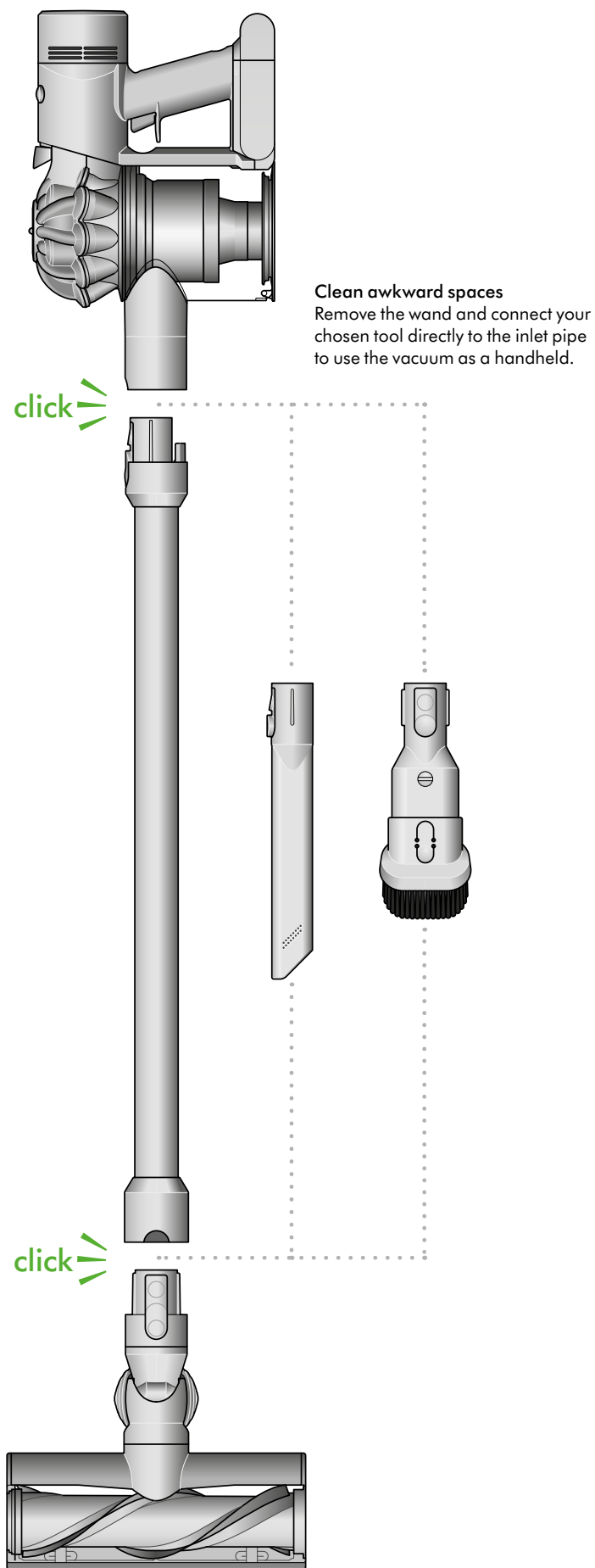

Clean awkward spaces
Remove the wand and connect your chosen tool directly to the inlet pipe to use the vacuum as a handheld.

Motorbar™ cleaner head
De-tangling vanes automatically clear wrapped hair from the brush bar as you clean.

Caring for your floors

Check that the underside of the cleaner head or tool is clean and free from any objects that may cause damage.

Before vacuuming your flooring, rugs, and carpets, check the manufacturer's recommended cleaning instructions.

The brush bar on your machine can damage certain flooring. Some rug materials may fuzz if a rotating brush bar is used when vacuuming. If this happens, we recommend vacuuming without the motorised floor tool and consulting with your flooring manufacturer.

Charging your machine

Fully charge your machine before your first use. Connect to charger either directly or in the dock.

A full charge will take approximately 4.5 hours. While your battery is charging, the LEDs will flash with the current level of charge. These lights will turn off once your machine is fully charged.

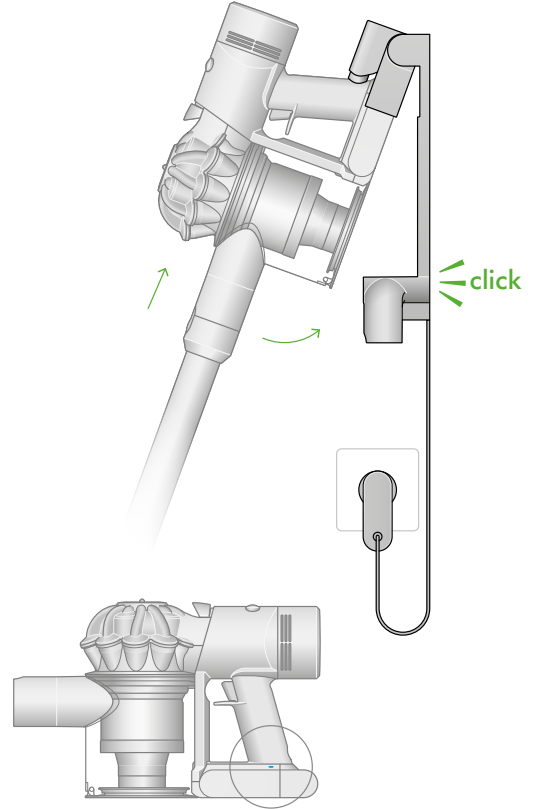
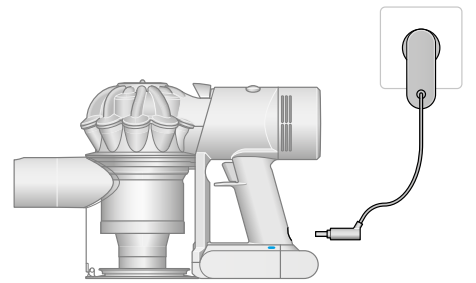

Battery LEDs

During use, high charge.



During use, medium charge.



During use, low charge.



Empty.



Charging LEDs

Charging, low charge.



Charging, medium charge.



Charging, nearly full.



Fully charged.



Battery fault.



Charger fault.

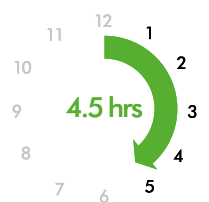

Emptying your bin

Empty as soon as the dirt reaches the MAX level – don't overfill. Using your machine when the dirt is above the MAX line may affect the performance and require more frequent filter washing.

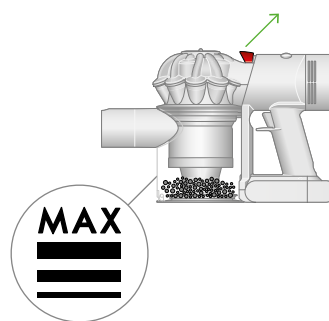

Release the dirt

Remove the wand from your machine.

Hold your machine over the bin and pull the bin release catch upwards. The cyclone will slide up and the bin base will open.

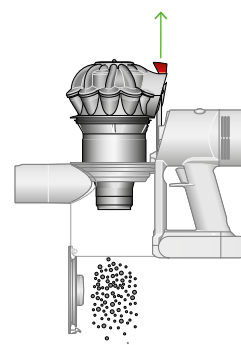

Minimise dust contact

Cover your bin tightly in a dustproof bag while you empty. Remove the bin carefully, seal the bag tightly and dispose.

Close the bin

Push down on the cyclone until it slides into position.

Push the bin base upwards until it closes securely.

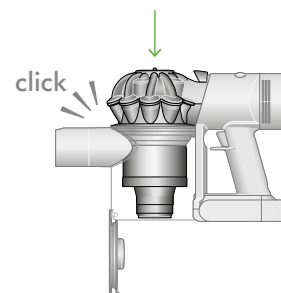

Cleaning your bin

Empty your bin as soon as the dirt reaches the MAX mark.
You may need to clean the filter more often if you use your machine with a full bin.

Empty your bin

Remove the wand from your machine.

Hold your machine over a bin and pull the bin release catch upwards.
The cyclone will slide up and the bin base will open.

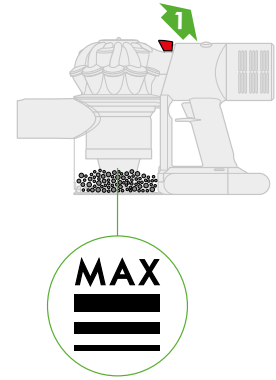

Remove the cyclone

Pull the bin release catch upwards. The cyclone will slide up and the bin base will open.

Locate the cyclone release button behind the cyclone and push to remove the cyclone from your machine.

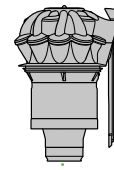

Remove the bin

Pull back on the red catch located on the base, slide the bin down and pull it off your machine.

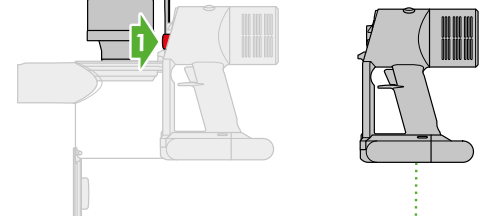

Clean the bin

Wipe your bin with a damp, lint-free cloth. Don't put the bin in a dishwasher or use detergents, polishes or air fresheners.

Make sure the bin is completely dry before replacing.

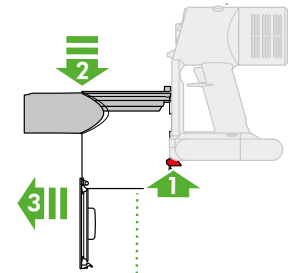

Replace the bin

Align the tabs on the bin with the grooves on the main body and slide it upwards until it clicks into place.

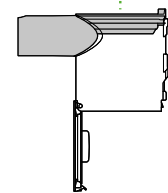

Replace the cyclone

Slide the cyclone into the grooves of the main body and push down until it is in position.

Push the bin base up until it clicks firmly shut.

Clearing blockages

Your machine is fitted with an automatic cut-out. If any part of it is blocked, your machine's motor will pulse and won't function until the blockage has been cleared.

Disconnect your machine from the charger before looking for blockages.
Be careful not to touch the trigger and be aware of sharp objects.

Leave your machine to cool down before looking for blockages.

Don't use your machine when looking for blockages as this could cause injury.

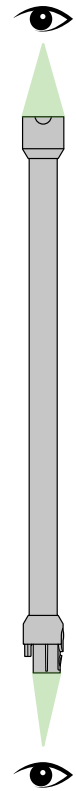
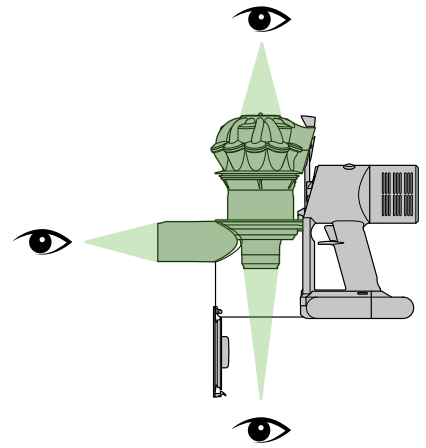

Washing filter A

Remove your filter

Lift the filter out of the top of the cyclone.

Tap to remove excess dust and debris.

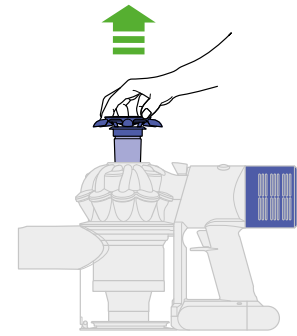

Wash your filter

Hold the open end of the filter under a running tap, until the water runs clear.

Turn the filter upside down and tap it to remove excess water.

Run water over the outside of the filter until the water runs clear.

Squeeze and twist with both hands to make sure the excess water is removed.

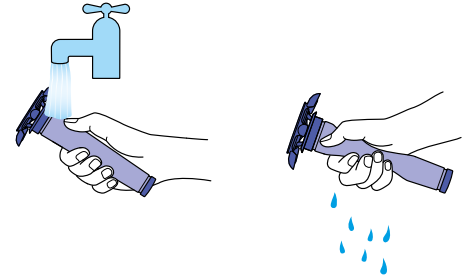

Dry your filter

Leave your filter to dry for at least 24 hours in a well-ventilated, warm place.

Do not dry your filter in a tumble-dryer or near a naked flame.

Important: your filter must be completely dry before you put it back into the machine. Your machine could be damaged if used with a damp filter.

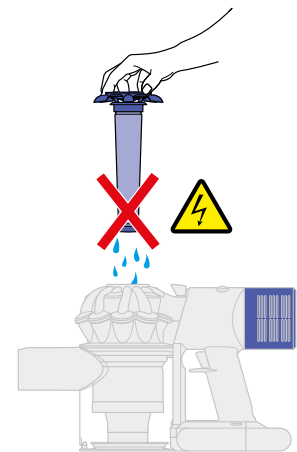
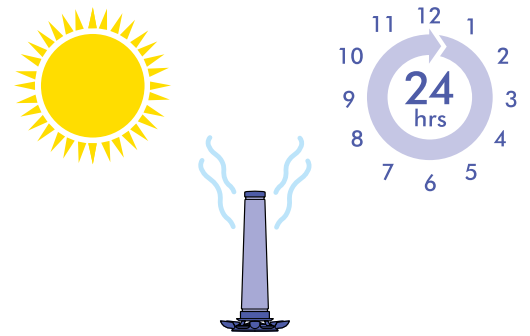

Refit your filter

Align the arrow on the top of the filter with the bin release button.

Push down to fit securely in place.

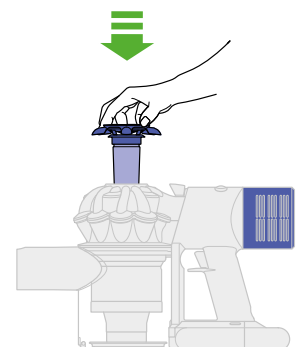

Washing filter B

Twist off your filter

Twist your filter anti-clockwise and pull it away from your machine.

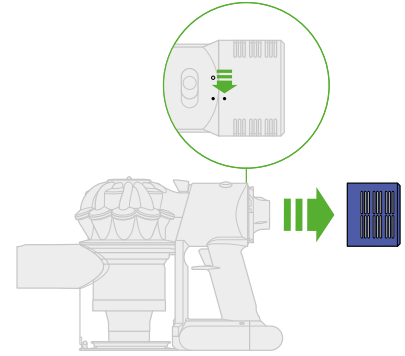

Wash your filter

Wash the inside of the filter under cold, running water, rotating the filter to make sure all the inside is clean.

Repeat until the water runs clear.

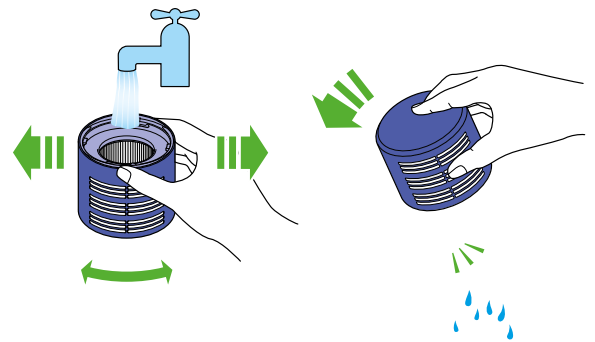

Shake out the water

Empty the filter and shake firmly to remove excess water.

Keep shaking it until there's no water coming from the filter.

Dry your filter

Place your filter, with the open end facing up, to dry.

Leave your filter to dry for at least 24 hours in a well-ventilated, warm place.

Do not dry your filter in a tumble-dryer or near a naked flame.

Important: your filter must be completely dry before you put it back into the machine. Your machine could be damaged if used with a damp filter.

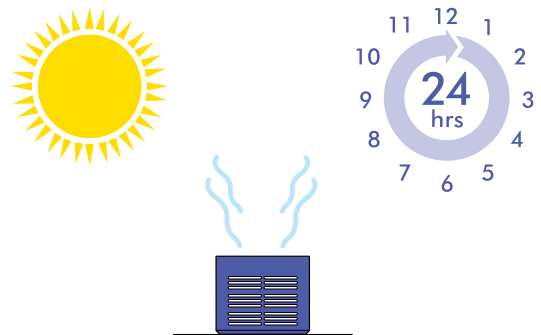

Replace your filter

Place your filter on your machine, aligned in the open position. Twist clockwise until it clicks securely into position.

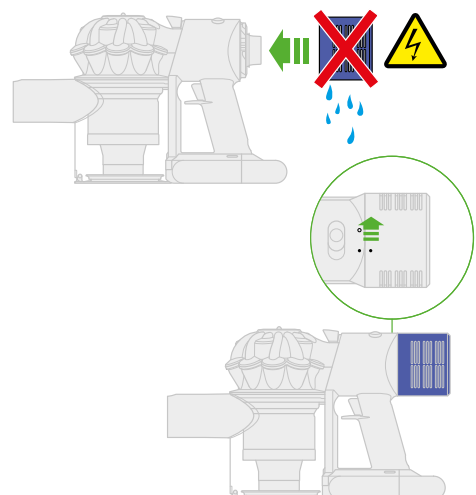

Clearing obstructions from your Motorbar™ cleaner head

Your Motorbar™ cleaner head doesn't have a washable brush bar. To maintain optimum performance, check your brush bar regularly and clear any obstructions.

Make sure your machine is disconnected from the charger and take care not to touch the trigger.



Remove your brush bar

Don't put any part of your machine in a dishwasher or use detergents, polishes or air fresheners.

Press the cleaner head release button on the end of the wand. Place the cleaner head upside down.

Use a coin to unlock the end cap.

Twist the end cap and remove it from your brush bar. Don't wash the end cap.

Slide your brush bar out of the cleaner head.

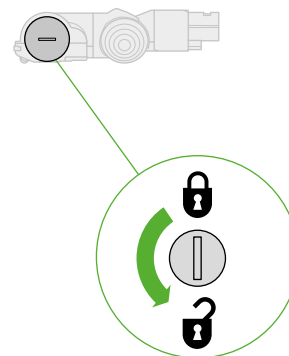

Look for obstructions

Clear any debris from your brush bar.

Check inside the cleaner head and remove any debris or blockages.

Your Motorbar™ cleaner head and brush bar aren't washable. Wipe over with a damp lint-free cloth.

Replace your brush bar

Push the end cap back on to your brush bar and slide it back into the cleaner head.

Turn the end cap clockwise into the locked position.

Your cleaner head isn't washable and should only be wiped over with a damp lint-free cloth.

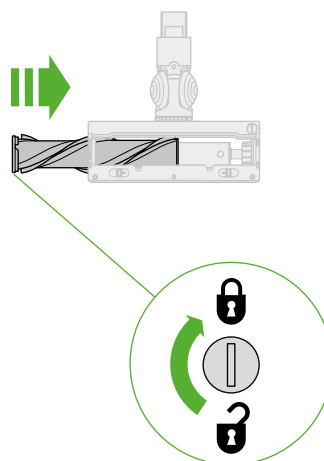

Clearing blockages from your Mini motorised tool

Your Mini motorised tool doesn't have a washable brush bar. To maintain optimum performance, check your brush bar regularly and clear any obstructions.

Make sure your machine is disconnected from the charger and take care not to touch the trigger.

Remove your brush bar

Don't put any part of your machine in a dishwasher or use detergents, polishes or air fresheners.

Use a coin to unlock the end cap.

Twist the end cap and remove it from your brush bar. Don't wash the end cap.

Slide your brush bar out of the cleaner head.

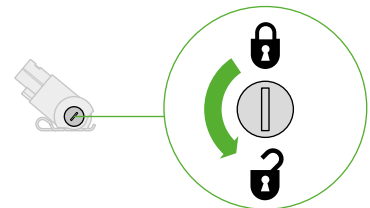

Look for obstructions

Clear any debris from your brush bar.

Check inside the cleaner head and remove any debris or blockages.

Your Mini motorised tool and brush bar aren't washable. Wipe over with a damp lint-free cloth.

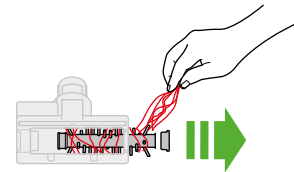

Replace your brush bar

Push the end cap back on to your brush bar and slide it back into the cleaner head.

Turn the end cap into the locked position.

Your cleaner head isn't washable and should only be wiped over with a damp lint-free cloth.

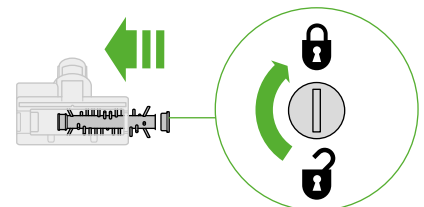

Washing your Fluffy™ cleaner head brush bar

Your Fluffy™ cleaner head has a washable brush bar. To maintain optimum performance, check and wash your brush bar regularly.

Make sure your machine is disconnected from the charger and take care not to touch the trigger.

Remove your brush bar

Don't put any part of your machine in a dishwasher or use detergents, polishes or air fresheners.

Press the cleaner head release button on the end of the wand. Place the cleaner head upside down.

Push the end cap up fully and pull the brush bar out of the cleaner head.

Remove the end cap from the brush bar. Don't wash the end cap.

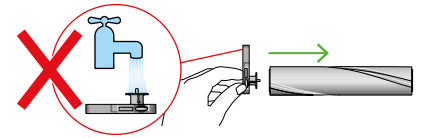
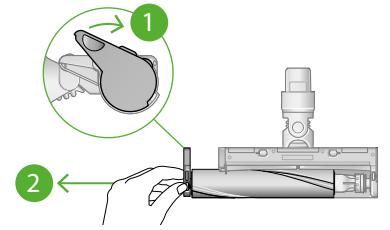

Wash and dry your brush bar

Hold your brush bar under running water and gently rub to remove any lint or dirt.

Remove as much excess water as possible, run your hand down the length of the brush bar to squeeze out the water.

Stand your brush bar upright, with the closed end at the top. Leave to dry completely for at least 24 hours.

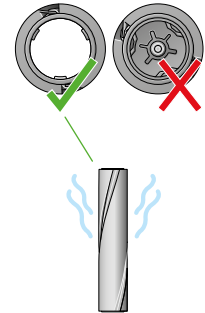

Replace your brush bar

Before replacing, check that your brush bar is completely dry.

Reattach the end cap to your brush bar.

Slide your brush bar into the cleaner head. Push the end cap back down to the closed position.

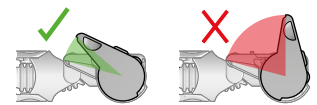
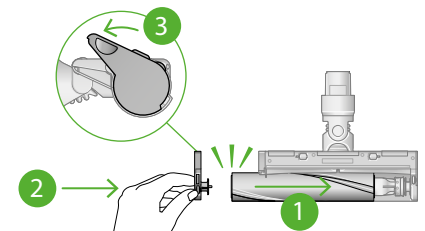

Cleaning your tools

Don't put any part of your machine in a dishwasher or use detergents, polishes or air fresheners.

Wipe with a damp, lint-free cloth, without touching the connector end.

Make sure your tools are completely dry before using.



Combination tool



Crevice tool

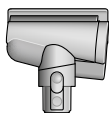

Hair screw tool

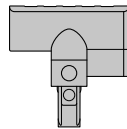

Mini motorised tool



Soft dusting brush



Stubborn dirt brush

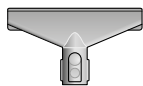

Fabric and mattress tool



Extension hose



Low-reach adaptor

Looking after your machine

To always get the best performance from your machine, it's important to clean it regularly and check for blockages.

Look after your machine

If your machine is dusty, wipe with a damp lint-free cloth.

Check for blockages in the cleaner head, tools and main body of your machine.

Wash your filter regularly and leave to dry completely.

Don't use detergents or polishes to clean your machine.

Look after your battery

To get the best performance and life from your battery, use Powerful suction mode.

Your machine won't operate or charge if the ambient temperature is below 5°C (41°F). This is designed to protect both the motor and battery.

Your serial numbers

You can register your machine using the serial number found on the bottom of your machine.

You can find your serial numbers on your machine, battery and charger. Use your serial number to register.