

# SAMSUNG

# FULL MANUAL

---

## HW-C430

Imagine the possibilities

Thank you for purchasing this Samsung product.

To receive more complete service, please register  
your product at [www.samsung.com/register](http://www.samsung.com/register)

# SAFETY INFORMATION









## SAFETY WARNINGS

TO REDUCE THE RISK OF ELECTRIC SHOCK, DO NOT REMOVE THE COVER (OR BACK).

NO USER-SERVICEABLE PARTS ARE INSIDE.

REFER SERVICING TO QUALIFIED SERVICE PERSONNEL.

Refer to the table below for an explanation of symbols which may be on your Samsung product.

	<p style="text-align: center;"><b>CAUTION</b> <b>RISK OF ELECTRIC SHOCK.</b> <b>DO NOT OPEN.</b></p>	
	<p>This symbol indicates that high voltage is present inside. It is dangerous to make any kind of contact with any internal part of this product.</p>	
	<p>This symbol indicates that this product has included important literature concerning operation and maintenance.</p>	
	<p>Class II product : This symbol indicates that it does not require a safety connection to electrical earth (ground). If this symbol is not present on a product with a power cord, the product <b>MUST</b> have a reliable connection to protective earth (ground).</p>	
	<p>AC voltage : This symbol indicates that the rated voltage marked with the symbol is AC voltage.</p>	
	<p>DC voltage : This symbol indicates that the rated voltage marked with the symbol is DC voltage.</p>	
	<p>Caution, Consult instructions for use : This symbol instructs the user to consult the user manual for further safety related information.</p>	

## WARNING

- To reduce the risk of fire or electric shock, do not expose this appliance to rain or moisture.

## CAUTION

- TO PREVENT ELECTRIC SHOCK, MATCH WIDE BLADE OF PLUG TO WIDE SLOT, FULLY INSERT.
- This apparatus shall always be connected to a AC outlet with a protective grounding connection.
- To disconnect the apparatus from the mains, the plug must be pulled out from the mains socket, therefore the mains plug shall be readily operable.
- Do not expose this apparatus to dripping or splashing. Do not put objects filled with liquids, such as vases on the apparatus.
- To turn this apparatus off completely, you must pull the power plug out of the wall socket. Consequently, the power plug must be easily and readily accessible at all times.

## Wiring the Main Power Supply Plug (UK Only)

### IMPORTANT NOTICE

The mains lead on this equipment is supplied with a moulded plug incorporating a fuse. The value of the fuse is indicated on the pin face of the plug and if it requires replacing, a fuse approved to BS1362 of the same rating must be used. Never use the plug with the fuse cover removed. If the cover is detachable and a replacement is required, it must be of the same colour as the fuse fitted in the plug. Replacement covers are available from your dealer. If the fitted plug is not suitable for the power points in your house or the cable is not long enough to reach a power point, you should obtain a suitable safety approved extension lead or consult your dealer for assistance.

However, if there is no alternative to cutting off the plug, remove the fuse and then safely dispose of the plug. Do not connect the plug to a mains socket as there is a risk of shock hazard from the bared flexible cord. Never attempt to insert bare wires directly into a mains socket. A plug and fuse must be used at all times.

### **IMPORTANT**

The wires in the mains lead are coloured in accordance with the following code:– BLUE = NEUTRAL BROWN = LIVE As these colours may not correspond to the coloured markings identifying the terminals in your plug, proceed as follows:– The wire coloured BLUE must be connected to the terminal marked with the letter N or coloured BLUE or BLACK. The wire coloured BROWN must be connected to the terminal marked with the letter L or coloured BROWN or RED.

**WARNING : DO NOT CONNECT EITHER WIRE TO THE EARTH TERMINAL WHICH IS MARKED WITH THE LETTER E OR BY THE EARTH SYMBOL , OR COLOURED GREEN OR GREEN AND YELLOW.**

## **PRECAUTIONS**

1. Ensure that the AC power supply in your house complies with the power requirements listed on the identification sticker located on the bottom of your product. Install your product horizontally, on a suitable base (furniture), with enough space around it for ventilation (7~10 cm). Make sure the ventilation slots are not covered. Do not place the unit on amplifiers or other equipment which may become hot. This unit is designed for continuous use. To fully turn off the unit, disconnect the AC plug from the wall outlet. Unplug the unit if you intend to leave it unused for a long period of time.

2. During thunderstorms, disconnect the AC plug from the wall outlet. Voltage peaks due to lightning could damage the unit.
  3. Do not expose the unit to direct sunlight or other heat sources. This could lead to overheating and cause the unit to malfunction.
  4. Protect the product from moisture (i.e. vases), and excess heat (e.g. a fireplace) or equipment creating strong magnetic or electric fields. Unplug the power cable from the AC wall socket if the unit malfunctions. Your product is not intended for industrial use. It is for personal use only. Condensation may occur if your product has been stored in cold temperatures. If transporting the unit during the winter, wait approximately 2 hours or until the unit has reached room temperature before using.
  5. The battery used with this product contains chemicals that are harmful to the environment. Do not dispose of the battery in the general household trash. Do not expose the battery to excess heat, direct sunlight, or fire. Do not short circuit, disassemble, or overheat the battery.
- CAUTION :** Danger of explosion if the battery is replaced incorrectly. Replace only with the same or equivalent type.

# CONTENTS

<b>01</b>	<b>Checking the Components</b>	<b>6</b>
<b>02</b>	<b>Product Overview</b>	<b>7</b>
	Front Panel / Top Panel of the Soundbar	7
	Bottom Panel of the Soundbar	8
<b>03</b>	<b>Using the Remote Control</b>	<b>9</b>
	Inserting Batteries before using the Remote Control (AAA batteries X 2)	9
	How to Use the Remote Control	9
	Using the Hidden Buttons (Buttons with more than one function)	13
	Output specifications for the different sound effect modes	13
	Adjusting the Soundbar volume with a TV remote control	14
<b>04</b>	<b>Connecting the Soundbar</b>	<b>15</b>
	Connecting Electrical Power	15
	Connecting the Soundbar to the Subwoofer	16
	Connecting the Samsung Wireless Rear Kit to your Soundbar	18
<b>05</b>	<b>Using a wired connection to the TV</b>	<b>19</b>
	Connecting using an Optical Cable	19
<b>06</b>	<b>Using a wireless connection to the TV</b>	<b>20</b>
	Connecting a TV via Bluetooth	20

<b>07</b>	<b>Connecting an External Device</b>	<b>22</b>
	Connecting using an Optical Cable	22
<b>08</b>	<b>Connecting a USB Storage Device</b>	<b>23</b>
<b>09</b>	<b>Connecting a Mobile Device</b>	<b>25</b>
	Connecting via Bluetooth	25
<b>10</b>	<b>Installing the Wall Mount</b>	<b>28</b>
	Installation Precautions	28
	Wallmount Components	28
<b>11</b>	<b>Placing the Soundbar on a TV stand</b>	<b>30</b>
<b>12</b>	<b>Software Update</b>	<b>31</b>
	Update Procedure	31
	If UPDATE is not displayed	32
<b>13</b>	<b>Troubleshooting</b>	<b>33</b>
<b>14</b>	<b>Licence</b>	<b>34</b>
<b>15</b>	<b>Open Source Licence Notice</b>	<b>35</b>
<b>16</b>	<b>Important Notes About Service</b>	<b>35</b>
<b>17</b>	<b>Specifications and Guide</b>	<b>36</b>
	Specifications	36

# 01 CHECKING THE COMPONENTS

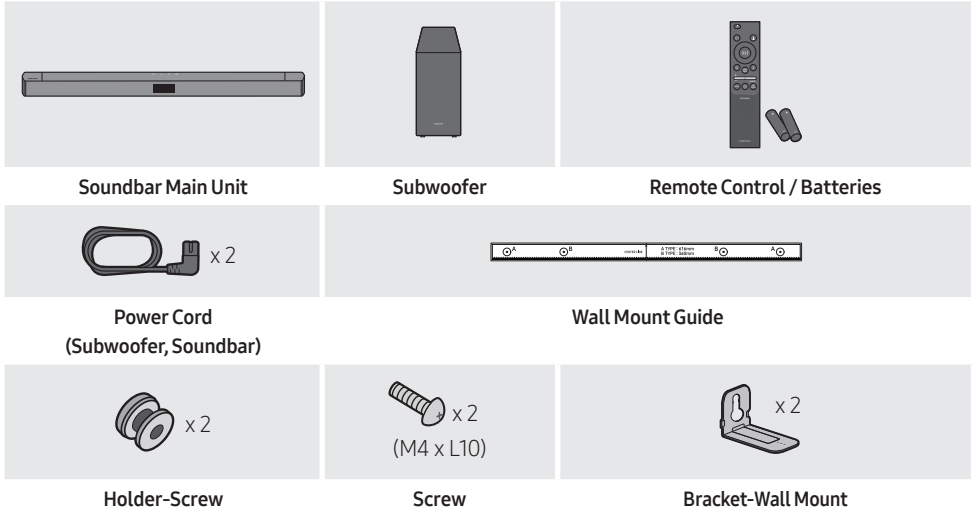

- For more information about the power supply and power consumption, refer to the label attached to the product. (Label: Bottom of the Soundbar Main Unit)
- To purchase additional components or optional cables, contact a Samsung Service Centre or Samsung Customer Care.
- The appearance of the accessories may differ slightly from the illustrations above.
- Design and specifications are subject to change without prior notice.

# 02 PRODUCT OVERVIEW

## Front Panel / Top Panel of the Soundbar

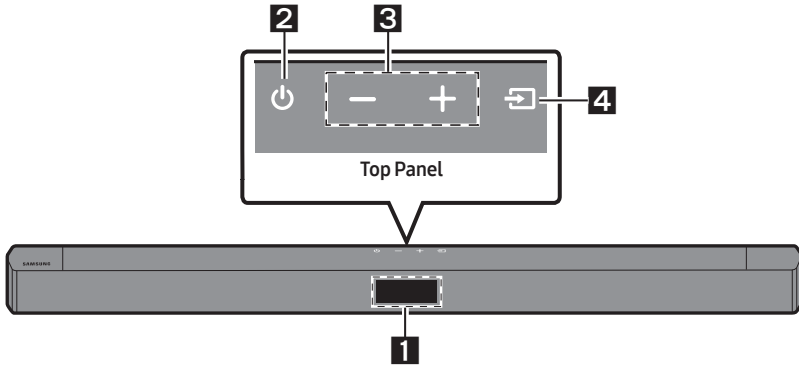

<b>1</b>	<p><b>Display</b> Displays the product's status and current mode.</p>								
<b>2</b>	<p><b>⏻ (Power) Button</b> Turns the power on and off.</p> <ul style="list-style-type: none"> <li>• <b>Auto Power Down Function</b> The unit turns off automatically in the following situations:             <ul style="list-style-type: none"> <li>- In <b>D.IN / BT / USB</b> Mode : If there is no audio signal for 18 minutes.</li> </ul> </li> </ul>								
<b>3</b>	<p><b>— + (Volume) Button</b> Adjusts the volume.</p> <ul style="list-style-type: none"> <li>• When adjusted, the volume level appears on the Soundbar's front display.</li> </ul>								
<b>4</b>	<p><b>↔ (Source) Button</b> Selects the source input mode.</p> <table border="1" style="width: 100%; border-collapse: collapse;"> <thead> <tr> <th style="text-align: center;">Input mode</th> <th style="text-align: center;">Display</th> </tr> </thead> <tbody> <tr> <td style="text-align: center;">Optical Digital input</td> <td style="text-align: center;">D.IN</td> </tr> <tr> <td style="text-align: center;">BLUETOOTH mode</td> <td style="text-align: center;">BT</td> </tr> <tr> <td style="text-align: center;">USB mode</td> <td style="text-align: center;">USB</td> </tr> </tbody> </table> <ul style="list-style-type: none"> <li>• To turn on "<b>BT PAIRING</b>" mode, change the source to "<b>BT</b>" mode in "<b>BT READY</b>" state and then press and hold the <b>↔ (Source)</b> button for more than 5 seconds.</li> </ul>	Input mode	Display	Optical Digital input	D.IN	BLUETOOTH mode	BT	USB mode	USB
Input mode	Display								
Optical Digital input	D.IN								
BLUETOOTH mode	BT								
USB mode	USB								

- When you plug in the AC cord, the power button will begin working in 4 to 6 seconds.

- When you turn on this unit, there will be a 4 to 5 second delay before it produces sound.
- If you want to enjoy sound only from the Soundbar, you must turn off the TV's speakers in the Audio Setup menu of your TV. Refer to the owner's manual supplied with your TV.

## Bottom Panel of the Soundbar

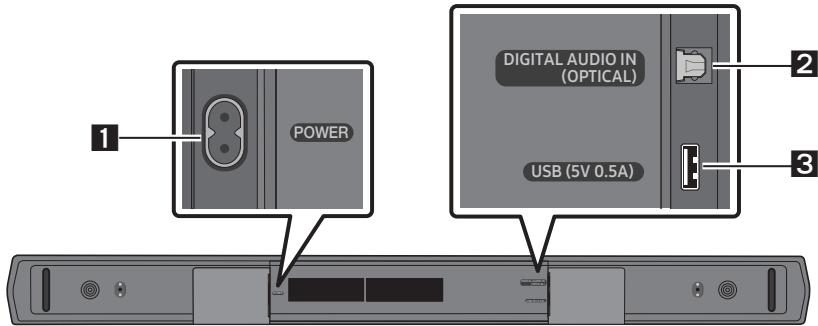

<b>1</b>	<b>POWER</b> Connect the Soundbar's AC power cable.
<b>2</b>	<b>DIGITAL AUDIO IN (OPTICAL)</b> Connect to the digital (optical) output of an external device.
<b>3</b>	<b>USB (5V 0.5A)</b> Connect a USB device here to play music files stored on the USB device through the Soundbar.

- When disconnecting the power cord from a wall outlet, pull the plug. Do not pull the cable.
- Do not connect this unit or other components to an AC outlet until all connections between components are complete.



# 03 USING THE REMOTE CONTROL



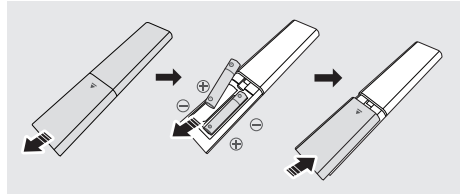

## Inserting Batteries before using the Remote Control (AAA batteries X 2)



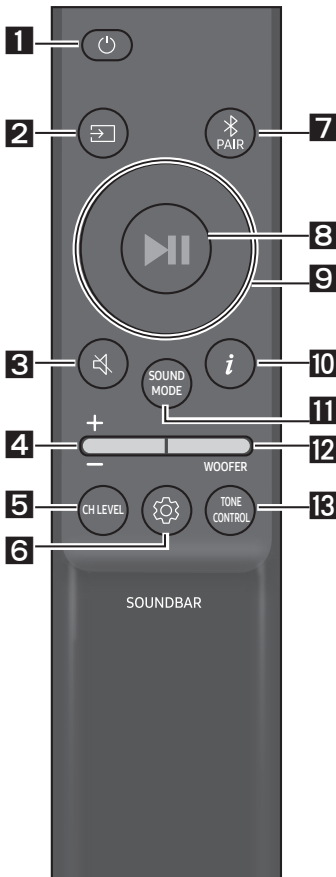



Slide the back cover in the direction of the arrow until it is completely removed. Insert 2 AAA batteries (1.5V) so that their orientation is correct. Slide the back cover back into position.









## How to Use the Remote Control



<b>1</b>	 <b>Power</b>	Turns the Soundbar on and off.
<b>2</b>	 <b>Source</b>	Press to select a source connected to the Soundbar.
<b>3</b>	 <b>Mute</b>	Press the  ( <b>Mute</b> ) button to mute the sound. Press it again to unmute the sound.
<b>4</b>	 <b>Volume</b>	Push the button up or down to adjust the volume. <div data-bbox="744 1037 912 1181" data-label="Image"> </div> <ul style="list-style-type: none"> <li> <b>Mute</b>            Press the <b>Volume</b> button in to mute the sound. Press it in again to unmute the sound.           <div data-bbox="744 1292 912 1436" data-label="Image"> </div> </li> </ul>

<p><b>5</b></p>	 <p><b>CH LEVEL</b></p>	<p>By pressing the button, you can adjust the volume of each speaker.</p> <ul style="list-style-type: none"> <li>• Press the button to select <b>VIRTUAL CENTER LEVEL</b> and then adjust the volume between -6~+6 by using the <b>Up/Down</b> buttons.</li> <li>• If the Rear Speakers (sold separately) are connected, the setting <b>REAR LEVEL</b> is supported. To adjust the volume of the <b>REAR LEVEL</b> between -6 to +6 by using the <b>Up/Down</b> buttons.</li> </ul>
<p><b>9</b></p>	 <p><b>Up/Down/ Left/Right</b></p>	 <p><b>Press the indicated areas to select Up/Down/Left/Right.</b></p> <p>Press Up/Down/Left/Right on the button to select or set functions.</p> <ul style="list-style-type: none"> <li>• <b>Repeat</b> To use the Repeat function in <b>"USB"</b> mode, press the <b>Up</b> button.</li> <li>• <b>Music Skip</b> Press the <b>Right</b> button to select the next music file. Press the <b>Left</b> button to select the previous music file.</li> <li>• <b>ID SET</b> Press and hold the <b>Up</b> button for 5 seconds to complete <b>ID SET</b> (when connecting to a wireless subwoofer or wireless rear speakers).</li> </ul>
<p><b>6</b></p>	 <p><b>Sound Control</b></p>	<p>By pressing the button, you can set the audio function. The desired settings can be adjusted using the <b>Up/Down</b> buttons.</p> <p><b>AUDIO SYNC → VOICE ENHANCE ON/OFF → NIGHT MODE ON/OFF</b></p> <ul style="list-style-type: none"> <li>- <b>AUDIO SYNC</b> If the video on the TV and audio from the Soundbar are not synchronised, press the  (<b>Sound Control</b>) button to select <b>AUDIO SYNC</b> and then set the audio delay between 0~300 milliseconds by using the <b>Up/Down</b> buttons. (Not available in <b>"USB"</b> or <b>"BT"</b> mode.)</li> <li>- <b>VOICE ENHANCE ON/OFF</b> This mode is makes it easier to hear spoken dialog in movies and TV.</li> <li>- <b>NIGHT MODE ON/OFF</b> This mode is optimized for nighttime viewing with the settings adjusted to bring the volume down but keep the dialog clear.</li> <li>• The <b>VOICE ENHANCE</b>, and <b>NIGHT MODE</b> audio function can be turned <b>ON/OFF</b> by using the <b>Up/Down</b> buttons.</li> <li>• Press and hold the  (<b>Sound Control</b>) button for about 5 seconds to adjust the sound for each frequency band. 150Hz, 300Hz, 600Hz, 1.2kHz, 2.5kHz, 5kHz, and 10kHz are selectable using the <b>Left/Right</b> buttons and each can be adjusted to a setting between -6 to +6 using the <b>Up/Down</b> buttons. (Make sure the Sound mode is set to <b>"STANDARD"</b>.)</li> </ul>

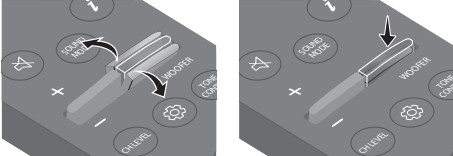
<p><b>7</b></p>  <p><b>Bluetooth PAIR</b></p>	<p>Press the <b>PAIR</b> button. “<b>BT PAIRING</b>” appears in the Soundbar’s display. You can connect the Soundbar to a new Bluetooth device in this mode by selecting the Soundbar from the Bluetooth device’s search list.</p>
<p><b>8</b></p>  <p><b>Play / Pause</b></p>	<p>Press the <b>▶  </b> button to pause a music file temporarily. When you press the button again, the music file will resume playing.</p>
<p><b>10</b></p>  <p><b>Info</b></p>	<p>Press the button to display information about the current function. (See page 7.)</p>
<p><b>11</b></p>  <p><b>SOUND MODE</b></p>	<p>By pressing the button, you can select the desired sound mode.</p> <p><b>SURROUND SOUND → GAME → DTS VIRTUAL:X → STANDARD</b></p> <ul style="list-style-type: none"> <li>– <b>SURROUND SOUND</b> Provides a wider sound field than standard.</li> <li>– <b>GAME</b> Provides stereoscopic sound to immerse you in the action while gaming.</li> <li>– <b>DTS VIRTUAL:X</b> Immersive 3D sound from any content.</li> <li>– <b>STANDARD</b> Outputs the original sound.</li> <li>• <b>DRC (Dynamic Range Control)</b> Lets you apply dynamic range control to Dolby Digital tracks. Press and hold the <b>SOUND MODE</b> button for more than 5 seconds while the Soundbar is powered off to turn DRC (Dynamic Range Control) on or off. With the DRC turned on, loud sound is reduced. (The sound may be distorted.)</li> <li>• <b>Bluetooth Power</b> This feature automatically turns the Soundbar on when it receives a connection request from a previously connected TV or Bluetooth device. The setting is On by default. <ul style="list-style-type: none"> <li>– Press and hold the <b>SOUND MODE</b> button for more than 5 seconds while the soundbar is powered on to turn off the Bluetooth Power function.</li> </ul> </li> </ul>

<p><b>12</b></p>	 <p>WOOFER WOOFER (BASS) LEVEL</p>	 <p>Push the button up or down to adjust the level of the woofer (bass) to -12 or between -6 to +6. To set the woofer (bass) volume level to 0 (Default), press the button.</p>
<p><b>13</b></p>	 <p>TONE CONTROL</p>	<p>By pressing the button, you can adjust the volume of the treble or bass sound.</p> <ul style="list-style-type: none"> <li>• Press the button to select <b>TREBLE</b> or <b>BASS</b> and then adjust the volume between -6~+6 by using the <b>Up/Down</b> buttons.</li> </ul>

## Using the Hidden Buttons (Buttons with more than one function)

Hidden Button		Reference page
Remote Control Button	Function	
WOOFER (Up)	TV remote control On/Off (Standby)	page 14
Left	TV Connect On/Off (BT Ready)	page 21
Up	ID SET	page 10
 (Sound Control)	7 Band EQ (Press and hold 5 seconds)	page 10
	Reset (Press and hold 10 seconds)	page 31
SOUND MODE	DRC ON/OFF (Standby)	page 11
	Bluetooth Power	page 11

## Output specifications for the different sound effect modes

Effect		Input	Output	
			Without Wireless Rear Speaker Kit	With Wireless Rear Speaker Kit
 SOUND MODE	SURROUND SOUND	2.0 ch	2.1 ch	4.1 ch
		5.1 ch	2.1 ch	4.1 ch
	GAME	2.0 ch	2.1 ch	4.1 ch
		5.1 ch	2.1 ch	4.1 ch
	DTS VIRTUAL:X	2.0 ch	2.1 ch	4.1 ch
		5.1 ch	2.1 ch	4.1 ch
	STANDARD	2.0 ch	2.1 ch	2.1 ch
		5.1 ch	2.1 ch	2.1 ch





- The Samsung Wireless Rear Speaker Kit can be purchased separately. To purchase a Kit, contact the vendor you purchased the Soundbar from.

# Adjusting the Soundbar volume with a TV remote control

Adjust the Soundbar volume using the TV's remote control.

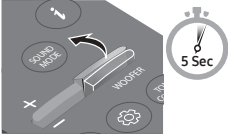
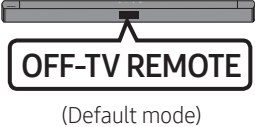
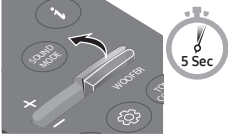
- This function can be used with IR remote controls only. Bluetooth remote controls (remote controls that require pairing) are not supported.
- Set the TV speaker to **External Speaker** to use this function.
- Manufacturers supporting this function:  
Samsung, VIZIO, LG, Sony, Sharp, PHILIPS, PANASONIC, TOSHIBA, Hisense, RCA

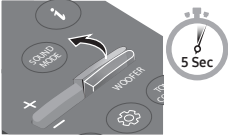
1. Turn Off the Soundbar.
2. Push up and hold the **WOOFER** button for 5 seconds.  
Each time you push the **WOOFER** button up and hold it for 5 seconds, the mode switches in the following order: "**OFF-TV REMOTE**" (Default mode), "**SAMSUNG-TV REMOTE**", "**ALL-TV REMOTE**".

Remote Control Button	Display	Status
		Disable the TV remote control.
		Enable a Samsung TV's IR remote control.
		Enable a third-party TV's IR remote control.

# 04 CONNECTING THE SOUNDBAR

## Connecting Electrical Power

Use the power components to connect the Subwoofer and Soundbar to an electrical outlet in the following order:

1. Connect the power cord to the Subwoofer.
2. Connect the power cord to the Soundbar.

See the illustrations below.

- For more information about the required electrical power and power consumption, refer to the label attached to the product. (Label: Bottom of the Soundbar Main Unit)

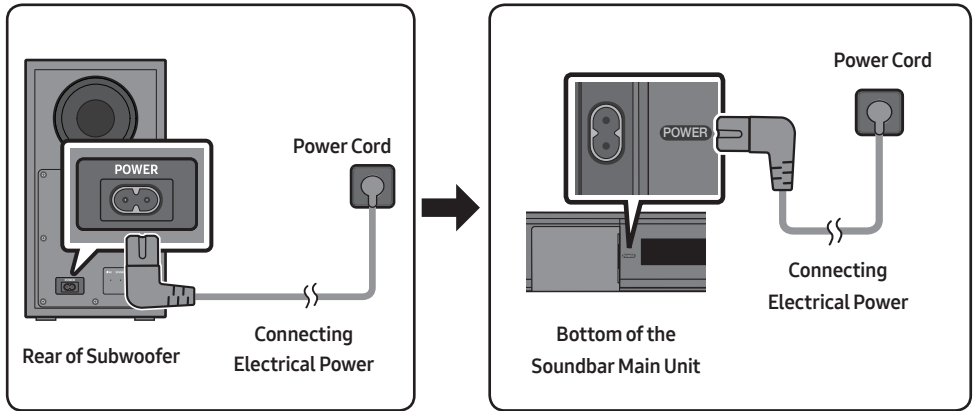

# Connecting the Soundbar to the Subwoofer

When the subwoofer is connected, you can enjoy rich bass sound.

## Automatic connection between the Subwoofer and the Soundbar

When you turn the power on after connecting the power cables to the Soundbar and subwoofer, the subwoofer is automatically connected to the Soundbar.

- When auto pairing is complete, the blue indicators at the rear of the subwoofer turn on.

## LED Indicator Lights on the Rear of Subwoofer

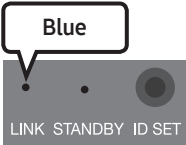
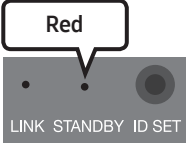
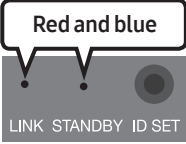
LED	Status	Description	Resolution
	On	Successfully connected (normal operation)	-
	Blinking	Recovering the connection	Check if the power cable attached to the main Soundbar unit is connected properly or wait about 5 minutes. If blinking persists, try manually connecting the subwoofer. See page 17.
	On	Standby (with the Soundbar main unit turned off)	Check if the power cable attached to the main Soundbar unit is connected properly.
		Connection failed	Connect again. See the instructions for manual connection on page 17.
	Blinking	Malfunction	See the contact information for the Samsung Service Centre in this manual.



## Manually connecting the Subwoofer if automatic connection fails

### Before performing the manual connection procedure below:

- Check whether the power cables for the Soundbar and subwoofer are connected properly.
- Make sure that the Soundbar is turned on.

1. Press and hold **ID SET** on the rear of the subwoofer for at least 5 seconds.
  - The red indicator on the rear of the subwoofer turns off and the blue indicator blinks.

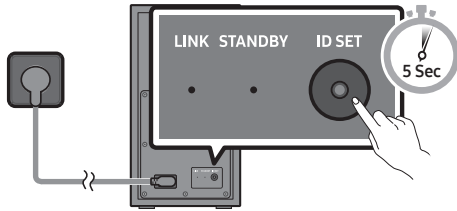

Rear of Subwoofer

2. First, press the button on the remote control to turn on the display. Press and hold the **Up** button on the remote control for at least 5 seconds.
  - The **ID SET** message appears on the display of the Soundbar for a moment, and then it disappears.
  - The Soundbar will automatically power on when **ID SET** is complete.

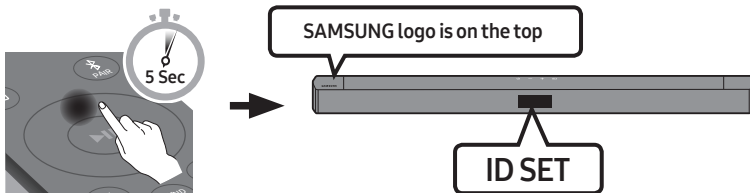

3. Check if the LINK LED is solid blue (connection complete).

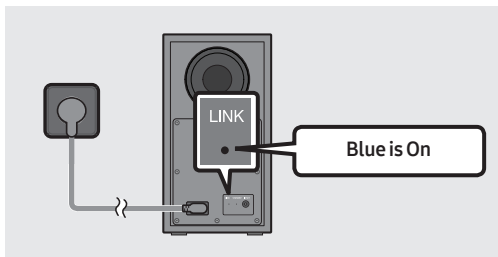

The LINK LED indicator stops blinking and glows a solid blue when a connection is established between the Soundbar and the Wireless Subwoofer.

## NOTES

- Do not connect the power cord of this product or your TV to a wall outlet until all connections between components are complete.
- Before moving or installing this product, be sure to turn off the power and disconnect the power cord.
- If the main unit is powered off, the wireless subwoofer will go into stand-by mode and the STANDBY LED on the rear of the sub-woofer will turn red after blinking blue several times.
- If you use a device that uses the same frequency (5.8GHz) as the Soundbar near the Soundbar, interference may cause some sound interruption.
- The maximum transmission distance of the main unit's wireless signal is about 10 m, but may vary depending on your operating environment. If a steel-concrete or metallic wall is between the main unit and the wireless subwoofer, the system may not operate at all because the wireless signal cannot penetrate metal.

## PRECAUTIONS

- Wireless receiving antennas are built into the wireless subwoofer. Keep the unit away from water and moisture.
- For optimal listening performance, make sure that the area around the wireless subwoofer and the Wireless Receiver Module (sold separately) is clear of any obstructions.

## Connecting the Samsung Wireless Rear Kit to your Soundbar

Expand to true wireless surround sound by connecting the Samsung Wireless Rear Speaker Kit (SWA-9200S sold separately) to your Soundbar.

For detailed information on connections, see the Samsung Wireless Rear Speaker Kit manual.

# 05 USING A WIRED CONNECTION TO THE TV

Hear TV sound from your Soundbar through wired or wireless connections.

- When the Soundbar is connected to selected Samsung TVs, the Soundbar can be controlled using the TV's remote control.
  - This feature is supported by 2017 and later Samsung Smart TVs that support Bluetooth when you connect the Soundbar to the TV using an optical cable.
  - This function also allows you to use the TV menu to adjust the sound field and various settings as well as the volume and mute.

## Connecting using an Optical Cable

When the audio in a broadcast is encoded in Dolby Digital and the “Digital Output Audio Format” on your TV is set to PCM, we recommend that you change the setting to Dolby Digital. When the setting on the TV is changed, you will experience better sound quality. (The TV menu may use different words for Dolby Digital and PCM depending on the TV manufacturer.)

### Pre-connection Checklist

- When you use an optical cable and the terminals have covers, be sure to remove the covers.



- When using an optical cable, it must be set to “D.IN” mode.

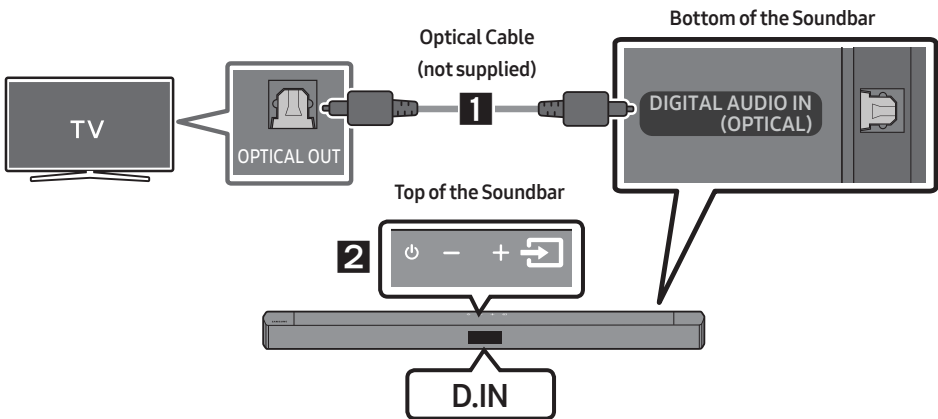

1. Connect the **DIGITAL AUDIO IN (OPTICAL)** port on the Soundbar to the OPTICAL OUT port of the TV with a digital optical cable (not supplied).
2. Press the  (**Source**) button on the top panel or remote control, and then select the “D.IN” mode.

# 06 USING A WIRELESS CONNECTION TO THE TV

## Connecting a TV via Bluetooth

When a TV is connected using Bluetooth, you can hear stereo sound without the hassle of cabling.

- Only one TV can be connected at a time.

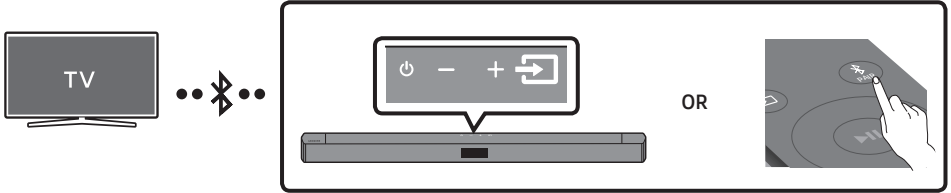

### The initial connection

1. Press the **PAIR** button on the remote control to enter the **"BT PAIRING"** mode.

(OR) a. Press the **Source** button on the top panel and then select **"BT"**.

**"BT"** changes to **"BT PAIRING"** in a few seconds automatically or changes to **"BT READY"** if there is a connect record.

- b. When **"BT READY"** appears, press and hold the **Source** button on the top panel of the Soundbar for more than 5 seconds to display **"BT PAIRING"**.

2. Select Bluetooth mode on the TV. (For more information, see the TV's manual.)

3. Select **"[AV] Samsung Soundbar C4-Series"** or **"[AV] Soundbar C4-Series"** from the list on TV's screen.

An available Soundbar is indicated with **"Needs Pairing"** or **"Paired"** on the TV's Bluetooth device list. To connect the TV to the Soundbar, select the message, and then establish a connection.

- When the TV is connected, **[TV Name]** → **"BT"** appears on the Soundbar's front display.

4. You can now hear TV sound from the Soundbar.

### If the Soundbar is not found by the TV

- Connect the TV and Soundbar with an optical cable, and select the **"D.IN"** mode by pressing **Source** button on the top of the Soundbar. See if the audio output works normally, and proceed with the step 2 and 3.

## If the device fails to connect

- If a previously connected Soundbar listing (e.g. “[AV] Samsung Soundbar C4-Series” or “[AV] Soundbar C4-Series”) appears in the list, delete it.
- Then repeat steps 1 through 3.

## NOTE



- After you have connected the Soundbar to your TV the first time, use the “**BT READY**” mode to reconnect.

## Disconnecting the Soundbar from the TV

Press the  (**Source**) button on the top panel or on the remote control and switch to any mode but “**BT**”.

- Disconnecting takes time because the TV must receive a response from the Soundbar. (The time required may differ, depending on the TV model.)
- To cancel the automatic Bluetooth connection between the Soundbar and TV, press the **Left** button on the remote control for 5 seconds with the Soundbar in “**BT READY**” status. (TV Connect On/Off)

## What is the difference between BT READY and BT PAIRING?

- **BT READY** : In this mode, you can search for previously connected TVs or connect a previously connected mobile device to the Soundbar.
- **BT PAIRING** : In this mode, you can connect a new device to the Soundbar. (Press the  **PAIR** button on the remote control or press and hold the  (**Source**) button on the top of the Soundbar for more than 5 seconds while the Soundbar is in “**BT**” mode and in “**BT READY**” state.)

## NOTES

- If asked for a PIN code when connecting a Bluetooth device, enter <0000>.
- In Bluetooth connection mode, the Bluetooth connection will be lost if the distance between the Soundbar and the Bluetooth device exceeds 10 m.
- The Soundbar automatically turns off after 18 minutes in the Ready state.
- The Soundbar may not perform Bluetooth search or connection correctly under the following circumstances:
  - If there is a strong electrical field around the Soundbar.
  - If several Bluetooth devices are simultaneously paired with the Soundbar.
  - If the Bluetooth device is turned off, not in place, or malfunctions.
- Electronic devices may cause radio interference. Devices that generate electromagnetic waves must be kept away from the Soundbar main unit - e.g., microwaves, wireless LAN devices, etc.

# 07 CONNECTING AN EXTERNAL DEVICE

Connect to an external device via a wired connection or Bluetooth connection to play the external device's sound through the Soundbar.

## Connecting using an Optical Cable

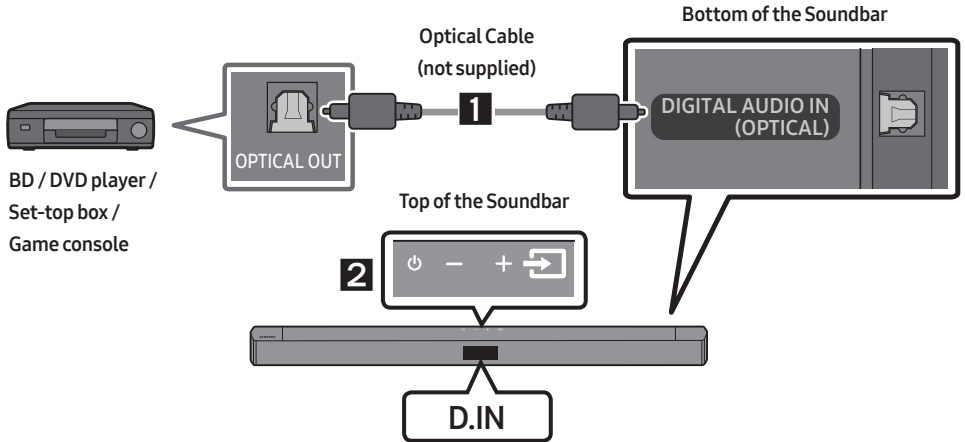

1. Connect **DIGITAL AUDIO IN (OPTICAL)** on the main unit to the OPTICAL OUT port of the Source Device using a digital optical cable (not supplied).
2. Select “**D.IN**” mode by pressing the  (**Source**) button on the top panel or on the remote control.

# 08 CONNECTING A USB STORAGE DEVICE

You can play music files located on USB storage devices through the Soundbar.

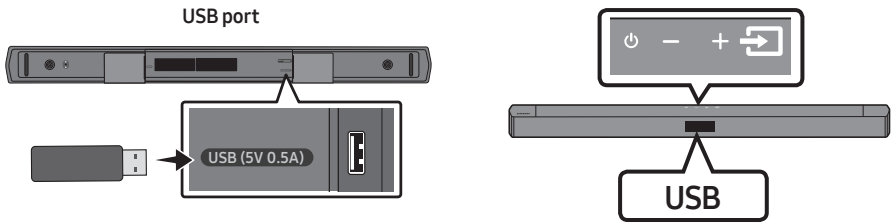

1. Connect the USB device to the USB port on the bottom of the product.
2. Press the  (**Source**) button on the top panel or on the remote control, and then select “USB”.
3. “USB” appears in the display screen.
4. Play music files from the USB storage device through the Soundbar.
  - The Soundbar automatically turns off (Auto Power Down) if no USB device has been connected for more than 18 minutes.

## File Format Type Compatibility list

Extension	Codec	Sampling Rate	Bitrate
*.mp3	MPEG 1 Layer2	32kHz ~ 48kHz	32kbps~320kbps
	MPEG 1 Layer3	32kHz ~ 48kHz	32kbps~320kbps
	MPEG 2 Layer3	16kHz ~ 24kHz	8kbps~160kbps
	MPEG 2.5 Layer3	8kHz ~ 12kHz	8kbps~160kbps
*.wma	WMA7/8/9	32kHz ~ 48kHz	32kbps~320kbps
*.ogg	Vorbis	32kHz ~ 48kHz	45kbps~500kbps
*.aac *.m4a *.mp4 (Audio Only)	AAC-LC (MPEG2,/ MPEG4)	32kHz ~ 48kHz	32kbps~320kbps
*.wav	LPCM	32kHz ~ 192kHz	1,024kbps~9,216kbps
*.flac	FLAC	32kHz ~ 192kHz	162kbps~8,100kbps
*.aiff	AIFF	32kHz ~ 192kHz	1,024kbps~9,216kbps

- If there are too many folders (about 256) and files (about 999) stored on the USB device, it may take the Soundbar some time to access and play files.
- Supported USB file system : FAT16, FAT32, NTFS



# 09 CONNECTING A MOBILE DEVICE

## Connecting via Bluetooth

When a mobile device is connected using Bluetooth, you can hear stereo sound without the hassle of cabling.

- You cannot connect more than one Bluetooth device at a time.

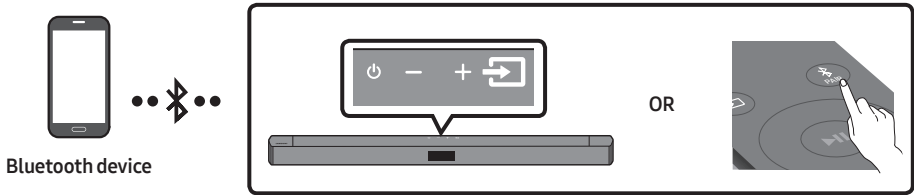

### The initial connection

1. Press the **PAIR** button on the remote control to enter the **"BT PAIRING"** mode.  
**(OR)** a. Press the **Source** button on the top panel and then select **"BT"**.  
"BT" changes to **"BT PAIRING"** in a few seconds automatically or changes to **"BT READY"** if there is a connect record.  
b. When **"BT READY"** appears, press and hold the **Source** button on the top panel of the Soundbar for more than 5 seconds to display **"BT PAIRING"**.
2. On your device, select **"[AV] Samsung Soundbar C4-Series"** or **"[AV] Soundbar C4-Series"** from the list that appears.
  - When the Soundbar is connected to the Bluetooth device, **[Bluetooth Device Name]** → **"BT"** appears in the front display.
3. Play music files from the device connected via Bluetooth through the Soundbar.



### If the device fails to connect

- If a previously connected Soundbar listing (e.g. **"[AV] Samsung Soundbar C4-Series"** or **"[AV] Soundbar C4-Series"**) appears in the list, delete it.
- Then repeat steps 1 and 2.

### NOTE

- After you have connected the Soundbar to your mobile device the first time, use the **"BT READY"** mode to reconnect.

## What is the difference between BT READY and BT PAIRING?

- **BT READY** : In this mode, you can search for previously connected TVs or connect a previously connected mobile device to the Soundbar.
- **BT PAIRING** : In this mode, you can connect a new device to the Soundbar. (Press the  **PAIR** button on the remote control or press and hold the  (**Source**) button on the top of the Soundbar for more than 5 seconds while the Soundbar is in “BT” mode and in “BT READY” state.)

## NOTES

- If asked for a PIN code when connecting a Bluetooth device, enter <0000>.
- In Bluetooth connection mode, the Bluetooth connection will be lost if the distance between the Soundbar and the Bluetooth device exceeds 10 m.
- The Soundbar automatically turns off after 18 minutes in the Ready state.
- The Soundbar may not perform Bluetooth search or connection correctly under the following circumstances:
  - If there is a strong electrical field around the Soundbar.
  - If several Bluetooth devices are simultaneously paired with the Soundbar.
  - If the Bluetooth device is turned off, not in place, or malfunctions.
- Electronic devices may cause radio interference. Devices that generate electromagnetic waves must be kept away from the Soundbar main unit - e.g., microwaves, wireless LAN devices, etc.
- The Soundbar supports SBC data (44.1kHz, 48kHz).
- Connect only to a Bluetooth device that supports the A2DP (AV) function.
- You cannot connect the Soundbar to a Bluetooth device that supports only the HF (Hands Free) function.
- Once you have paired the Soundbar to a Bluetooth device, selecting “[AV] Samsung Soundbar C4-Series” or “[AV] Soundbar C4-Series” from the device’s scanned devices list will automatically change the Soundbar to “BT” mode.
  - Available only if the Soundbar is listed among the Bluetooth device’s paired devices.  
(The Bluetooth device and the Soundbar must have been previously paired at least once.)
- The Soundbar will appear in the Bluetooth device’s searched devices list only when the Soundbar is displaying “BT READY”.
- The Soundbar cannot be paired to another Bluetooth device if already in Bluetooth mode and paired to a Bluetooth device.

## Bluetooth Power On (SOUND MODE)

If a previously paired Bluetooth device tries to pair with the Soundbar when the Bluetooth Power On function is on and the Soundbar is turned off, the Soundbar turns on automatically.

1. Press and hold the **SOUND MODE** button for more than 5 seconds on the remote while the Soundbar is turned on.
2. “**ON-BLUETOOTH POWER**” appears on the Soundbar’s display.

## Disconnecting the Bluetooth device from a Soundbar

You can disconnect a Bluetooth device from the Soundbar. For instructions, see the Bluetooth device's user manual.

- The Soundbar will be disconnected.
- When the Soundbar is disconnected from the Bluetooth device, the Soundbar will display **"BT DISCONNECTED"** on the front display.

## Disconnecting the Soundbar from the Bluetooth device

Press the  (**Source**) button on the top panel or on the remote control, and then change to any mode except **"BT"**.

- Disconnecting takes time because the Bluetooth device must receive a response from the Soundbar. (Disconnection time may differ, depending on the Bluetooth device)
- When the Soundbar is disconnected from the Bluetooth device, the Soundbar will display **"BT DISCONNECTED"** on the front display.

### **NOTES**

- In Bluetooth connection mode, the Bluetooth connection will be lost if the distance between the Soundbar and the Bluetooth device exceeds 10 m.
- The Soundbar automatically turns off after 18 minutes in the Ready state.

### **More About Bluetooth**

Bluetooth is a technology that enables Bluetooth-compliant devices to interconnect easily with each other using a short wireless connection.

- A Bluetooth device may cause noise or malfunction, depending on usage, if:
  - A part of your body is in contact with the receiving/transmitting system of the Bluetooth device or the Soundbar.
  - It is subject to electrical variation from obstructions caused by a wall, corner, or office partition.
  - It is exposed to electrical interference from same frequency-band devices including medical equipment, microwave ovens, and wireless LANs.
- Pair the Soundbar with the Bluetooth device while they are close together.
- The further the distance between the Soundbar and Bluetooth device, the worse the quality is. If the distance exceeds the Bluetooth operational range, the connection is lost.
- In poor reception areas, the Bluetooth connection may not work properly.
- The Bluetooth connection only works when it is close to the unit. The connection will be automatically cut off if the Bluetooth device is out of range. Even within range, the sound quality may be degraded by obstacles such as walls or doors.
- This wireless device may cause electric interference during its operation.

# 10 INSTALLING THE WALL MOUNT

## Installation Precautions

- Install on a vertical wall only.
- Do not install in a place with high temperature or humidity.
- Verify whether the wall is strong enough to support the product's weight. If not, reinforce the wall or choose another installation point.
- Purchase and use the fixing screws or anchors appropriate for the kind of wall you have (plaster board, iron board, wood, etc.). If possible, fix the support screws into wall studs.
- Purchase wall mounting screws according to the type and thickness of the wall you want to mount the Soundbar on.
  - Diameter: M5
  - Length: 35 mm or longer recommended.
- Connect cables from the unit to external devices before you install the Soundbar on the wall.
- Make sure the unit is turned off and unplugged from the power source before you install it. Otherwise, it may cause an electric shock.

## Wallmount Components

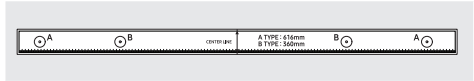

Wall Mount Guide

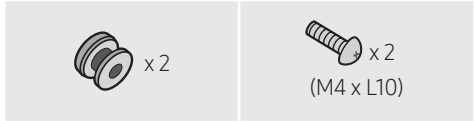

Holder-Screw

Screw



Bracket-Wall Mount

1. Place the **Wall Mount Guide** against the wall surface.
  - The **Wall Mount Guide** must be level.
  - If your TV is mounted on the wall, install the Soundbar at least 5 cm below the TV.

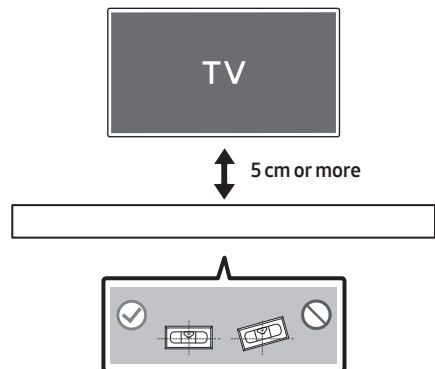

2. Align the **Wall Mount Guide's Centre Line** with the centre of your TV (if you are mounting the Soundbar below your TV), and then fix the **Wall Mount Guide** to the wall using tape.

- If you are not mounting below a TV, place the **Centre Line** in the centre of the installation area.

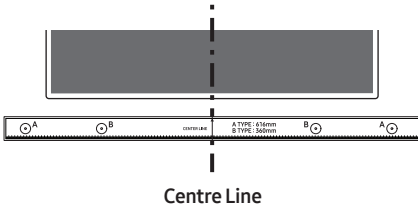

3. Push a pen tip or sharpened pencil tip through the centre of the **A-TYPE** images on each end of the Guide to mark the holes for the supporting screws, and then remove the **Wall Mount Guide**.

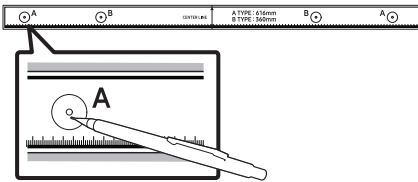

4. Using an appropriately sized drill bit, drill a hole in the wall at each marking.

- If the markings do not correspond to the positions of studs, make sure you insert appropriate anchors into the holes before you insert the support screws. If you use anchors, make sure the holes you drill are large enough for the anchors you use.

5. Push a screw (not supplied) through each **Holder-Screw**, and then screw each screw firmly into a support screw hole.

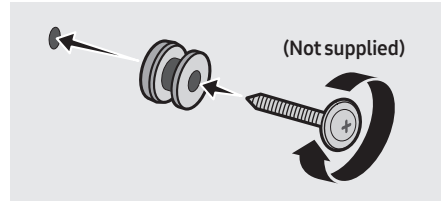

6. Install the 2 **Bracket-Wall Mounts** in the correct orientation on the bottom of the Soundbar using 2 **Screws**.

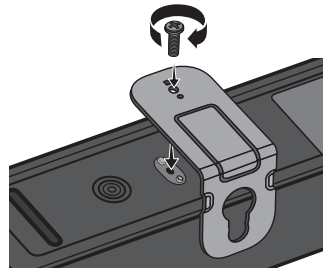

- When assembling, make sure the hanger part of the **Bracket-Wall Mounts** are located behind the rear of the Soundbar.

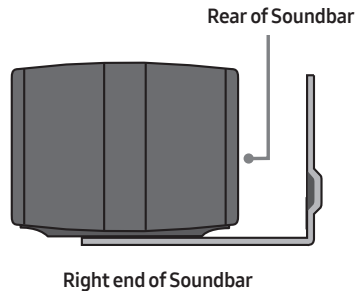

7. Install the Soundbar with the attached **Bracket-Wall Mounts** by hanging the **Bracket-Wall Mounts** on the **Holder-Screws** on the wall.

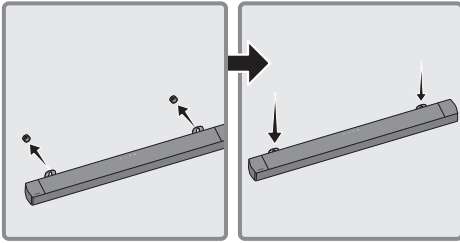

8. Slide the Soundbar down as shown below so that the **Bracket-Wall Mounts** rest securely on the **Holder-Screws**.
- Insert the **Holder-Screws** into the wide (bottom) part of the **Bracket-Wall Mounts**, and then slide the **Bracket-Wall Mounts** down so that the **Bracket-Wall Mounts** rest securely on the **Holder-Screws**.

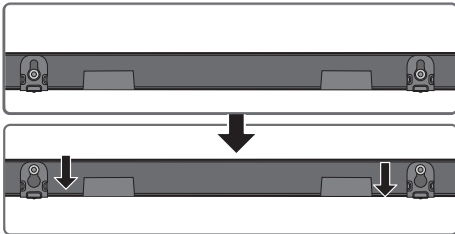

## 11 PLACING THE SOUNDBAR ON A TV STAND

Place the Soundbar on a TV stand.

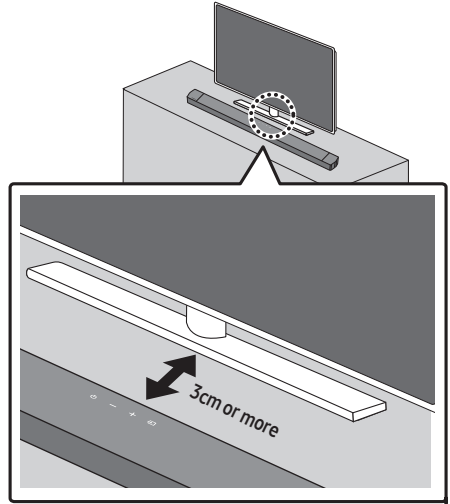

As illustrated in the image, align the centre of the Soundbar with the centre of the TV, carefully place the Soundbar onto the TV stand. For optimal sound quality, position the Soundbar at least 3cm away from the TV front.

### NOTE

- Make sure the Soundbar is placed on a flat and solid surface.

# 12 SOFTWARE UPDATE

Samsung may offer updates for the Soundbar's system firmware in the future.

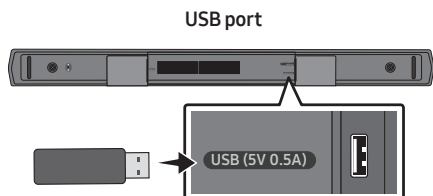

If an update is offered, you can update the firmware by connecting a USB device with the firmware update stored on it to the USB port on your Soundbar. For more information about how to download update files, go to the Samsung website at [www.samsung.com](http://www.samsung.com) → Support. Then, select the product type or enter the model number of your Soundbar, select the Software & Apps option, and then Downloads. Note that the option names can vary.

## Update Procedure

**Important:** The update function erases all user settings. We recommend you write down your settings so that you can easily reset them after the update. Note that updating the firmware resets the subwoofer connection too.

1. Connect a USB thumb drive to the USB port on your computer.

**Important:** Make sure there are no music files on the USB thumb drive. This may cause the firmware update to fail.

2. Go to ([samsung.com](http://samsung.com)) → select Enter Model Number and enter the model of your Soundbar. Select manuals and downloads and download the latest software file.
3. Save the downloaded software to a USB stick and select "Extract Here" to unzip the folder.
4. Turn off the Soundbar and connect the USB stick containing the software update to the USB port.
5. Turn on the Soundbar and change the source to "USB" mode. Within 3 minutes, "UPDATE" is displayed and the update begins.
6. When the update is complete, the Soundbar turns off. Turn on the Soundbar and then press the **— + (Volume)** button on the top panel for 5 seconds. "INIT OK" appears on the display and the Soundbar is reset.
  - This product has a DUAL BOOT function. If the firmware fails to update, you can update the firmware again. Soundbar AC code on when USB in with update file. Then update again but VFD no show anything, It will update finish after 2min.
7. Restore your settings on the Soundbar.

## If UPDATE is not displayed

1. Turn off the Soundbar, disconnect and then reconnect the USB storage device that contains the update files to the Soundbar's USB port.
2. Disconnect the Soundbar's power cord, reconnect it, and then turn on the Soundbar.

### NOTES

- The firmware update may not work properly if audio files supported by the Soundbar are stored in the USB storage device.
- Do not disconnect the power or remove the USB device while updates are being applied.
- After the update is completed, the user setup in the Soundbar maybe will be initialized. So we recommend you write down your settings so that you can easily reset them after the update. Note that updating firmware resets the subwoofer connection too.

If the connection to the subwoofer is not re-established automatically after the update, refer to page 16.

If the software update fails, check if the USB stick is defective.

- Mac OS users should use MS-DOS (FAT) as the USB format.
- Updating via USB may not be available, depending on the USB storage device manufacturer.



# 13 TROUBLESHOOTING

Before seeking assistance, check the following.

## Soundbar does not turn on.

- Check whether the power cord of the Soundbar is correctly inserted into the outlet.

## Soundbar works erratically.

- After removing the power cord, insert it again.
- Power the external device off/on and try again.
- If there is no signal, the Soundbar automatically turns off after a certain period of time. Turn on the power. (See page 7.)

## If the remote control does not work.

- Point the remote directly at the Soundbar.
- Replace the batteries with new ones.

## Soundbar does not output any sound.

- The volume of the Soundbar is too low or muted. Adjust the volume.
- When any external device (STB, Bluetooth device, mobile device, etc.) is connected, adjust the volume of the external device.
- For sound output of the TV, select Soundbar. (Samsung TV: Home (🏠) → Menu → Settings (⚙️) → All Settings (⚙️) → Sound → Sound Output → Select Soundbar)
- The cable connection to the Soundbar may be loose. Remove the cable and connect again.
- Remove the power cord completely, reconnect, and turn the power on.
- Reset the product and try again. (See page 31.)

## Subwoofer does not output any sound.

- Check whether the LED indicator on the rear of the Subwoofer is on in blue. Reconnect the Soundbar and Subwoofer if the indicator is blinking slowly in blue or turned red. (See page 17.)
- You may experience an issue if there is an obstacle between the Soundbar and Subwoofer. Move devices to an area away from obstacles.
- Other devices sending radio frequency signals in proximity may interrupt the connection. Keep your speaker away from such devices.
- Remove and reconnect the power plug.

## The Subwoofer volume is too low.

- The original volume of the content you are playing may be low. Try adjusting the Subwoofer level. (See page 12.)
- Bring the Subwoofer speaker closer to you.

## Soundbar does not appear on the Bluetooth device list of the TV.

- Disconnect the power cord of the Soundbar completely and reconnect, and then try searching again. (See page 20.)
- Connect the TV and Soundbar with an optical cable, and select the "D.IN" mode by pressing the  (Source) button on the top of the Soundbar. See if the audio output works normally, and try searching again. (See page 20.)

## 14 LICENCE

### Soundbar does not connect via Bluetooth.

- When connecting a new device, switch to "BT PAIRING" for connection. (Press the **PAIR** button on the remote control or press the **(Source)** button on the top of the soundbar for at least 5 seconds.)
- If the Soundbar is connected to another device, disconnect that device first to switch the device.
- Reconnect it after removing the Bluetooth speaker list on the device to connect. (Samsung TV: Home (🏠) → Menu → Settings (⚙️) → All Settings (⚙️) → Sound → Sound Output → Bluetooth Speaker List)
- Remove and reconnect the power plug, then try again.
- Reset the product and try again. (See page 31.)

### Sound drops out when connected via Bluetooth.

- Some devices can cause radio interference if they are located too close to the Soundbar. e. g. microwaves, wireless routers, etc.
- If your device that is connected via Bluetooth moves too far away from the Soundbar, it may cause the sound to drop out. Move the device closer to the Soundbar.
- If a part of your body is in contact with the Bluetooth transceiver or the product is installed on metal furniture, sound may drop out. Check the installation environment and conditions for use.

### Soundbar does not turn on automatically with the TV.

- When you turn off the Soundbar while watching TV, power synchronization with the TV is disabled. First turn off the TV.



Manufactured under license from Dolby Laboratories. Dolby, Dolby Audio, and the double-D symbol are trademarks of Dolby Laboratories Licensing Corporation. Confidential unpublished works. Copyright 1992-2019 Dolby Laboratories. All rights reserved.



For DTS patents, see <http://patents.dts.com>.

Manufactured under license from DTS Licensing Limited. DTS, Digital Surround, Virtual:X, and the DTS logo are registered trademarks or trademarks of DTS, Inc. in the United States and other countries. © 2021 DTS, Inc. ALL RIGHTS RESERVED.



The Bluetooth® word mark and logos are registered trademarks owned by Bluetooth SIG, Inc. and any use of such marks by Samsung Electronics Co., Ltd. is under license. Other trademarks and trade names are those of their respective owners.



### [ENERGY STAR]

#### **ENERGY STAR qualified model only**

- Your Samsung product is ENERGY STAR qualified in its factory default setting. Change to certain features, settings and functionality in this product can change the power consumption, possibly beyond the limits required for ENERGY STAR qualification.
- Environmental Protection Agency and Department of Energy. ENERGY STAR is a joint program of the Government agencies, designed to promote energy efficient products and practices.

Refer to [www.energystar.gov](http://www.energystar.gov) for more information of the ENERGY STAR Program.

#### **ENERGY STAR qualified model only (Applicable to Thin Client models only)**

As an ENERGY STAR® Partner, SAMSUNG has determined that this product meets the ENERGY STAR® guidelines for energy efficiency.

- The ENERGY STAR Program has been to reduced greenhouse gas emissions and save energy through voluntary labeling.
- Power management setting of this product have been enabled by default, and have various timing setting from 1 minutes to 5 hours.
- The product can wake with a button press on the chassis from sleep mode.

#### **ENERGY STAR qualified model only (The other models)**

- As an ENERGY STAR Partner, Samsung has determined that this product or product models meets the ENERGY STAR guideline for energy efficiency.
- 

## 15 OPEN SOURCE LICENCE NOTICE

To send inquiries and requests for questions regarding open sources, contact Samsung Open Source (<http://opensource.samsung.com>)

## 16 IMPORTANT NOTES ABOUT SERVICE

- Figures and illustrations in this User Manual are provided for reference only and may differ from actual product appearance.
- An administration fee may be charged if either
  - (a) an engineer is called out at your request and there is no defect with the product (i.e. where the user manual has not been read).
  - (b) you bring the unit to a repair centre and there is no defect with the product (i.e. where the user manual has not been read).
- You will be informed of the administration fee amount before a technician visits.

# 17 SPECIFICATIONS AND GUIDE

## Specifications

Model Name	HW-C430
USB	5V/0.5A
Weight	1.4 kg
Dimensions (W x H x D)	858.8 x 59.0 x 75.0 mm
Operating Temperature Range	+5°C to +35°C
Operating Humidity Range	10 % ~ 75 %
AMPLIFIER Rated Output power	40W x 2, 6 ohm
Supported play formats (DTS 2.0 sound is played in DTS format.)	LPCM 2ch, Dolby Audio™ (supporting Dolby® Digital), DTS
Subwoofer Name	PS-WC44T
Weight	4.4 kg
Dimensions (W x H x D)	181.5 x 343.0 x 272.0 mm
AMPLIFIER Rated Output power	190W
Overall Standby Power Consumption (W)	2.0W
Bluetooth Port deactivation method	Press and hold the <b>SOUND MODE</b> button for more than 5 seconds to turn off Bluetooth Power function.

## NOTES

- Samsung Electronics Co., Ltd reserves the right to change the specifications without notice.
- Weight and dimensions are approximate.

- Hereby, Samsung declares that this radio equipment is in compliance with Directive 2014/53/EU and the relevant UK statutory requirements. The full text of the declaration of conformity is available at the following internet address: <http://www.samsung.com> go to Support and enter the model name. This equipment may be operated in all EU countries and in the UK.
- **WIRELESS DEVICE OUTPUT POWER**  
**RF max transmitter power**  
 100mW at 2.4GHz – 2.4835GHz  
 25mW at 5.725GHz – 5.825GHz



**[Correct disposal of batteries in this product]**

**(Applicable in countries with separate collection systems)**

This marking on the battery, manual or packaging indicates that the batteries in this product should not be disposed of with other household waste at the end of their working life. Where marked, the chemical symbols Hg, Cd or Pb indicate that the battery contains mercury, cadmium or lead above the reference levels in EC Directive 2006/66.

If batteries are not properly disposed of, these substances can cause harm to human health or the environment.

To protect natural resources and to promote material reuse, please separate batteries from other types of waste and recycle them through your local, free battery return system.



**Correct Disposal of This Product**  
**(Waste Electrical & Electronic Equipment)**

**(Applicable in countries with separate collection systems)**

This marking on the product, accessories or literature indicates that the product and its electronic accessories (e.g. charger, headset, USB cable) should not be disposed of with other household waste at the end of their working life. To prevent possible harm to the environment or human health from uncontrolled waste disposal, please separate these items from other types of waste and recycle them responsibly to promote the sustainable reuse of material resources.

Household users should contact either the retailer where they purchased this product, or their local government office, for details of where and how they can take these items for environmentally safe recycling.

Business users should contact their supplier and check the terms and conditions of the purchase contract. This product and its electronic accessories should not be mixed with other commercial wastes for disposal.

For information on Samsung’s environmental commitments and product specific regulatory obligations e.g. REACH, WEEE, Batteries, visit:

[www.samsung.com/uk/aboutsamsung/sustainability/environment/our-commitment/data/](http://www.samsung.com/uk/aboutsamsung/sustainability/environment/our-commitment/data/)



# UNITED KINGDOM



# EIRE

This Samsung product is warranted for the period of twelve (12) months from the original date of purchase, against defective materials and workmanship. In the event that warranty service is required, you should return the product to the retailer from whom it was purchased. However, Samsung Authorised Dealers and Authorised Service Centres in other EC Countries will comply with the warranty on the terms issued to purchasers in the country concerned. In case of difficulty, details of our Authorised Service Centres are available from:

**Samsung Electronics U.K. Ltd**  
**Samsung Customer Support Centre**  
**Selectapost 38, Sheffield, S97 3FJ**  
**United Kingdom**

**United Kingdom**  
**Tel : 0333 000 0333**  
**[www.samsung.com/uk/support](http://www.samsung.com/uk/support)**

**EIRE**  
**Tel : 0818 717100**  
**[www.samsung.com/ie/support](http://www.samsung.com/ie/support)**

## ■ WARRANTY CONDITIONS

1. The warranty is only valid if, when warranty service is required, the warranty card is fully and properly completed and is presented with the original invoice or sales slip or confirmation, and the serial number on the product has not been defaced.
2. Samsung's obligations are limited to the repair or, at its discretion, replacement of the product or the defective part. Repaired or replaced products may include new and or refurbished components and equipment.
3. Warranty repairs must be carried out by Authorised Samsung Dealers or Authorised Service Centres. No re-imburement will be made for repairs carried out by non Samsung Dealers and, any such repair work and damage to the products caused by such repair work will not be covered by this warranty.
4. This product is not considered to be defective in materials nor workmanship by reason that it requires adaptation in order to conform to national or local technical or safety standards in force in any Country other than the one for which the product was originally designed and manufactured. This warranty will not cover, and no re-imburement will be made for such adaptation nor any damage which may result.
5. This warranty covers none of the following:
  - a) Periodic check ups, maintenance and repair or replacement of parts due to normal wear and tear.
  - b) Cost relating to transport, removal or installation of the product.
  - c) Misuse, including the failure to use this product for its normal purposes or incorrect installation.
  - d) Damage caused by Lightning, Water, Fire, Acts of God, War, Public Disturbances, incorrect mains voltage, improper ventilation or any other cause beyond the control of Samsung.
6. This warranty is valid for any person who legally acquired possession of the product during the warranty period.
7. The consumers' statutory rights in any applicable national legislation whether against the retailer arising from the purchase contract or otherwise are not affected by this warranty. Unless there is national legislation to the contrary, the rights under this warranty are the consumers' sole rights and Samsung, its subsidiaries and distributors shall not be liable for indirect or consequential loss or any damage to disc based media, removable memory or any other related equipment or material.
8. Samsung shall honour warranties for all EU specification products purchased by a consumer within the following European countries listed.
  - UK, Republic of Ireland, Germany, France, Italy, Malta, Spain, Portugal, The Netherlands, Belgium, Luxembourg, Denmark, Sweden, Finland, Poland, Hungary, Czech Republic, Slovakia, Austria, Slovenia, Croatia, Estonia, Latvia, Lithuania, Greece, Cyprus, Romania, Bulgaria, Switzerland, Norway, Lichtenstein and Iceland.

**SAMSUNG ELECTRONICS (U.K.) LTD.**

# SAMSUNG

© 2023 Samsung Electronics Co., Ltd. All rights reserved.

## Contact SAMSUNG WORLD WIDE

If you have any questions or comments relating to Samsung products, please contact the SAMSUNG customer care Centre.

Country	Samsung Service Centre ☎	Web Site	Country	Samsung Service Centre ☎	Web Site
<b>■ Europe</b>			CZECH	800 - SAMSUNG (800-726786)	www.samsung.com/cz/support
UK	0333 000 0333	www.samsung.com/uk/support	SLOVAKIA	0800 - SAMSUNG (0800-726 786)	www.samsung.com/sk/support
IRELAND (EIRE)	0818 717100	www.samsung.com/ie/support	CROATIA	072 726 786	www.samsung.com/hr/support
GERMANY	06196 77 555 77	www.samsung.com/de/support	BOSNIA	055 233 999	www.samsung.com/support
FRANCE	01 48 63 00 00	www.samsung.com/fr/support	NORTH MACEDONIA	023 207 777	www.samsung.com/mk/support
ITALIA	800-SAMSUNG (800.7267864)	www.samsung.com/it/support	MONTENEGRO	020 405 888	www.samsung.com/support
SPAIN	91 175 00 15	www.samsung.com/es/support	SLOVENIA	080 697 267 (brezplačna številka)	www.samsung.com/si/support
PORTUGAL	210 608 098 Chamada para a rede fixa nacional Dias úteis das 9h às 20h	www.samsung.com/pt/support	SERBIA	011 321 6899	www.samsung.com/rs/support
LUXEMBURG	261 03 710	www.samsung.com/be_fr/support	KOSOVO	038 40 30 90	www.samsung.com/support
NETHERLANDS	088 90 90 100	www.samsung.com/nl/support	ALBANIA	045 620 202	www.samsung.com/al/support
BELGIUM	02-201-24-18	www.samsung.com/be/support (Dutch) www.samsung.com/be_fr/support (French)	BULGARIA	0800 111 31 - Безплатен за всички оператори *3000 - Цена на един градски разговор или според тарифата на мобилният оператор 09:00 до 18:00 - Понеделник до Петък	www.samsung.com/bg/support
NORWAY	21629099	www.samsung.com/no/support	ROMANIA	0800872678 - Apel gratuit *8000 - Apel tarifat în rețea Program Call Center Luni - Vineri: 9 AM - 6 PM	www.samsung.com/ro/support
DENMARK	707 019 70	www.samsung.com/dk/support	CYPRUS	8009 4000 only from landline, toll free	www.samsung.com/gr/support
FINLAND	030-6227 515	www.samsung.com/fi/support	GREECE	80111-SAMSUNG (80111 726 7864) only from land line (+30) 210 6897691 from mobile and land line	
SWEDEN	0771-400 300	www.samsung.com/se/support	LITHUANIA	8-800-77777	www.samsung.com/lt/support
POLAND	801-172-678* lub +48 22 607-93-33* Specjalistyczna infolinia do obsługi zapytań dotyczących telefonów komórkowych: 801-672-678* * (opłata według taryfy operatora)	http://www.samsung.com/pl/support/	LATVIA	8000-7267	www.samsung.com/lv/support
HUNGARY	0680SAMSUNG (0680-726-7864)	www.samsung.com/hu/support	ESTONIA	800-7267	www.samsung.com/ee/support
AUSTRIA	0800 72 67 864 (0800-SAMSUNG)	www.samsung.com/at/support			
SWITZERLAND	0800 726 786	www.samsung.com/ch/support (German) www.samsung.com/ch_fr/support (French)			