

cookworks

2 Slice Toaster

Model No. T399HE



Care & Instruction Manual

For household and indoor use only

Please read these instructions before use and retain for future reference



Electrical safety



- You should only plug the appliance into a 220V-240V AC, 50Hz supply. Connecting it to other power sources may damage the appliance and will invalidate the guarantee.
- Switch off and unplug when not in use and before cleaning the appliance.
- Keep the appliance and its cord out of reach of children less than 8 years.
- Do not allow children to use the appliance without supervision.
- This appliance can be used by children aged from 8 years and above and persons with reduced physical, sensory or mental capabilities or lack of experience and knowledge if they have been given supervision or instruction concerning use of the appliance in a safe way and understand the hazards involved. Children shall not play with the appliance. Cleaning and user maintenance shall not be made by children unless they are older than 8 and supervised.
- Keep cable and plug and appliance dry and away from areas where it is likely to get splashed. Never immerse in water.
- Do not pull on the cable to disconnect from mains supply.
- Do not force bread that is too thick or wide into the toaster carriage. If bread becomes stuck in the toaster, switch off and unplug before removing. Be careful, do not damage the internal components and never use sharp objects such as forks or knives to dislodge the item.
- Do not operate the appliance if damaged or after it malfunctions. In the event the supply cord is damaged, in order to avoid a hazard it must only be replaced by a qualified service engineer, with a suitably approved part.
- This appliance must be positioned so that the plug is accessible and the plug socket is within easy reach of the power cord.
- This appliance must be plugged in to an earthed socket outlet.

Warning!

- This appliance is intended exclusively for use in domestic households. It is not suitable for commercial use.
- **Do not leave unattended during use.** Bread can catch fire if overdone.
- Do not use toasters directly under cupboards as this may damage the toaster and/or the cupboard. Always ensure a clear gap of at least 60cm above the toaster.
- Do not cover and allow the toaster to cool fully before storing.
- Do not operate the toaster using a timer or separate remote control.
- The surfaces of the toaster may become hot; wear oven gloves when handling the appliance during and immediately after use.
- Bread may burn, do not use the toaster on, near or under flammable materials (e.g. curtains) or heat sensitive surfaces.
- Do not use without the crumb tray correctly fitted and closed completely. Do not allow crumbs to build up in the tray, the crumb tray should be cleaned regularly.
- Do not place foil wrapped food in this toaster and remove all wrappings from food before toasting.
- Not suitable to toast bread and other foodstuffs coated or containing butter, other spreads or containing sugar and jams.
- When toasting raisin or other fruit breads, remove any loose raisins from the surface of the bread before placing in the toaster. This will help prevent pieces from falling into the toaster or sticking on the guard wire in the slot.
- To prevent jamming do not use your toaster with torn slices of bread. Make sure the size and thickness of the bread slices fit easily into the toast slots.

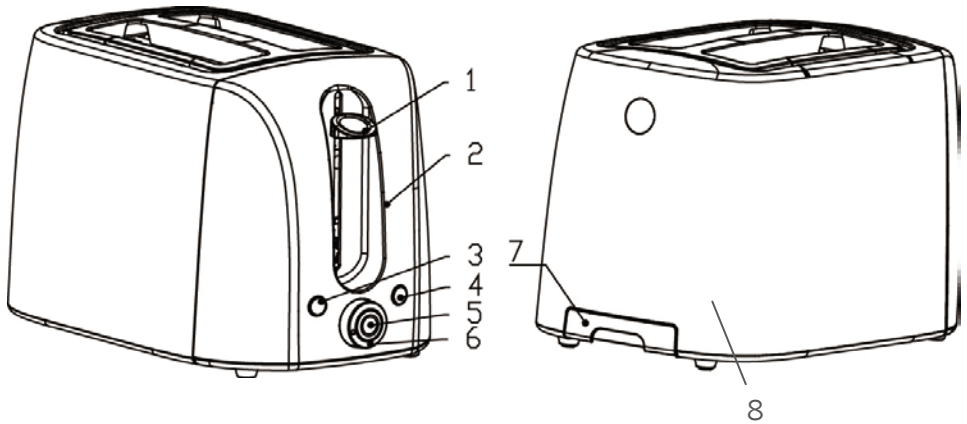

Parts



1. Carriage control lever
2. Sheel
3. Reheat button 
4. Frozen button 
5. Cancel button 
6. Browning control knob
7. Crumb tray

To use

1. Place the toaster on a stable, flat, heat resistant surface and away from any flammable materials.
2. Fully unwind the cable and plug in.
3. Select the degree of browning required by adjusting the browning control knob. A lighter coloured toast will be obtained by selecting the lower settings (1 & 2) and darker toast by selecting the higher settings (5&6).
4. After selecting an appropriate setting, place a slice of bread into each carriage and lower the toast by pressing down on the carriage handle and the power indicator in the button will illuminate. If the carriage does not stay down, check that the toaster is switched on at the socket.
5. The toast will automatically pop up when the toasting time has been completed. When using for the first time or changing bread types initially set the browning control at 3 and it is advisable to check at intervals to see if the desired browning level has been reached.

6. If using frozen bread, insert the bread into the carriage, lower the carriage and then press the FROZEN () button. The light in the button will come on and the toasting cycle will be extended slightly. The bread will automatically pop up when toasted.
7. To reheat cold toast, insert the bread into the carriage, lower the carriage and press the REHEAT () button. The light in the button will come on and the reheating cycle will start. The bread will automatically pop up when the cycle has been completed.
8. Toasting can be stopped at anytime by pressing the CANCEL button, or by unplugging the toaster.

Notes:

- Before using for the first time it is advisable to let the toaster complete several toasting cycles at the highest setting with no bread in the carriage. Allow the toaster to cool down between cycles.
- If the toast starts to smoke, press the CANCEL button immediately.
- Dry thin slices of bread will toast quicker than moist or thick slices and should be toasted on a lower setting.
- For best results when toasting crust slices, insert the bread so the crust side is nearest the outside of the toaster, and the cut side is nearest the middle of the toaster.
- Turn the browning control knob to a lower setting if you are toasting a single slice.

Cleaning.

Clean and empty the crumb tray on a regular basis. If the toaster is used frequently then it is recommended this is done weekly.

1. Switch off and unplug the toaster and allow it to cool.
2. Wipe external surfaces with a soft damp cloth and polish with a soft dry cloth. Do not use detergent or abrasives as these may scratch the surface.
3. Slide out the crumb tray from underneath the toaster, wipe clean and replace.
4. If there are pieces of bread remaining inside the toaster, turn the toaster upside down and gently shake.
5. Never touch the internal surfaces and always allow surfaces to

fully dry before using the toaster again.

Technical specification

Rated voltage	220 – 240V AC 50/60Hz
Power consumption	860-1050W
Class rating	I (earthed)
BS 1362 fuse	13A
Capacity	2 Slices



Plug / Wiring advice

The wires in this mains lead are coloured in accordance with the following UK electrical code:

- BLUE = NEUTRAL
- BROWN = LIVE
- GREEN + YELLOW = EARTH

Non-rewireable plug

This appliance may be fitted with a “non-rewireable” plug. If you need to change the fuse in a “non-rewireable” plug, the fuse cover must be refitted. If the fuse cover is lost or damaged, the appliance must not be used.

Rewireable plug

The colours of the wires in the mains lead of this appliance may not correspond with the coloured markings identifying the terminals in a rewireable plug. **Rewireable plugs should only be replaced by a suitably competent person. If in doubt, consult a qualified electrician.**

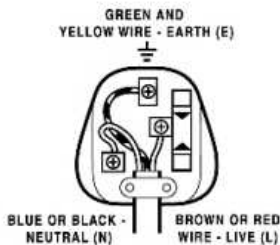

The BLUE wire must be connected to the terminal marked with the letter N

The BROWN wire must be connected to the terminal marked with the letter L

The GREEN & YELLOW wire must be connected to the terminal marked with the letter E or the earth symbol .

Recycling electrical products



This marking indicates that this product should not be disposed with other household wastes throughout the EU. To prevent possible harm to the environment or human health from uncontrolled waste disposal, recycle it responsibly to promote the sustainable reuse of material resources. To return your used device, please use the return and collection systems or contact the retailer where the product was purchased. They can take this product for environmental safe recycling.

If you encounter any problems with this product please call our customer care team on 0345 640 30 30

Produced in China for Argos Limited, 489 – 499 Avebury Boulevard Central Milton Keynes MK9 2NW. UK.



PRODUCT GUARANTEE

This product is guaranteed against manufacturing defects for a period of



Year

This product is guaranteed for twelve months from the date of original purchase.

Any defect that arises due to faulty materials or workmanship will either be replaced, refunded or repaired free of charge where possible during this period by the dealer from whom you purchased the unit.

The guarantee is subject to the following provisions:

- The guarantee does not cover accidental damage, misuse, cabinet parts, knobs or consumable items.
- The product must be correctly installed and operated in accordance with the instructions contained in this manual. A replacement copy of this instruction manual can be obtained from www.argos-support.co.uk
- It must be used solely for domestic purpose.
- The guarantee will be rendered invalid if the product is re-sold or has been damaged by inexpert repair.
- Specifications are subject to change without notice.
- The manufacturer disclaims any liability for the incidental or consequential damages.
- The guarantee is in addition to, and does not diminish your statutory or legal rights.

Guarantor: Argos Ltd
489 - 499 Avebury Boulevard
Central Milton Keynes
MK9 2NW

www.argos-support.co.uk