

BUSH

Instruction manual

Built-in Gas Hob
BGOGH60

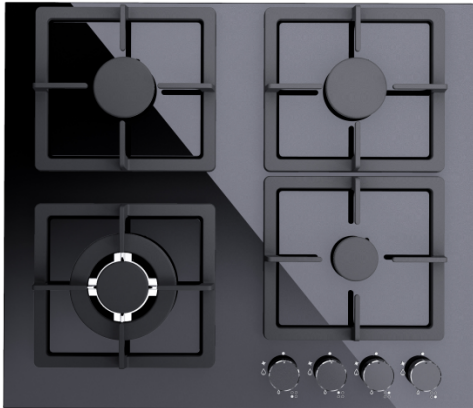

You'll soon be enjoying your new Built-in Gas Hob

It all begins here, with your instructions. Don't worry, there's nothing too technical coming up. Just simple, step-by-step guidance to get you up and running quickly. Sound good? Then let's get started.

Help and Guidance

We're here to help you get the most from your Built-in Gas Hob. Should you require any guidance, a simple solution can often be found online at:

www.bush-support.com

If you still require further assistance, call one of our experts on **01759 487838**.

Contents

1 Safety information

Safety information 6

2 Getting to know your Built in Gas Hob

Overview 11

Placement of Burner Heads and Caps 12

3 Installing your Built in GasHob

Advance Preparation 14

Positioning the Hob 14

Installing the Hob 16

Gas Conversion 18

Electrical Connection 19

4 Using your Built in Gas Hob

Controls 22

Using the Gas Hob Burners 23

5 Care and Maintenance

Cleaning 26

Routine maintenance 27

Technical specifications 28

6 Product support

Troubleshooting 30

Help and assistance 31

Declaration of conformance to product standards 32

Safety information

1





Safety information

Important - Please read these instructions fully before installing or operating

INSTALLATION WARNINGS

IMPORTANT: This product **MUST** be installed by a qualified Gas Safe registered installer in accordance with local regulations. Particular attention should be given to the ventilation requirements.

IMPORTANT: Prior to Installation ensure that the local supply conditions (electricity voltage and frequency) are compatible with the requirements of your cooker.

IMPORTANT: Carefully unpack and examine the appliance for any damage. If you think there is a defect, do not use the appliance and contact Bush Product Support on 01759 487838. Packaging materials should be collected together and disposed of immediately as they may be harmful to children.

IMPORTANT: Keep the electrical cable of your gas hob away from the hot areas of your cooker; do not let the cable touch the appliance. Keep the cable away from sharp edges and heated surfaces.

IMPORTANT: Ensure that the electric supply cable is not trapped or damaged during installation.

IMPORTANT: In the event that the cable connecting your gas hob becomes damaged, it must be replaced by a suitably qualified person. This cable must not be replaced by an unauthorised person.

IMPORTANT: Protect your gas hob against atmospheric effects. Do not expose your gas hob to effects such as sun, rain, snow etc.

IMPORTANT: The materials surrounding the appliance (cabinets) must be able to withstand a minimum temperature of 100°C.

WARNING: Before obtaining access to

terminals, all supply circuits must be disconnected.

DURING USAGE

IMPORTANT: This appliance can be used by children aged from 8 years and above and persons with reduced physical, sensory or mental capabilities or lack of experience and knowledge if they have been given supervision or instruction concerning use of the appliance in a safe way and understand the hazards involved. Children shall not play with the appliance. Cleaning and user maintenance shall not be made by children without supervision.

WARNING: The appliance and its accessible parts become hot during use. Care should be taken to avoid touching heating elements. Children less than 8 years of age shall be kept away unless continuously supervised.

WARNING: Cooking on a hob with fat or oil can be dangerous and should not be left unattended.

WARNING: NEVER try to extinguish a cooking fire with water. Instead switch off the appliance and cover flame e.g. with a lid or a fire blanket.

CAUTION: Do not allow children in the kitchen when cooking or while hob parts may still be hot. Many parts of the hob will become hot and present a considerable hazard to children.

CAUTION: Before starting to use your appliance, ensure curtains, paper or flammable items are kept away from your appliance. Do not keep flammable materials inside of or around your gas hob.

WARNING: If the surface is cracked, switch off the appliance to avoid the possibility of electric shock.

If you require any technical guidance or find that your product is not operating as intended, a simple solution can often be found in the **Troubleshooting** section of these instructions.



Safety information

Important - Please read these instructions fully before installing or operating

IMPORTANT: Position pans over the centre of the burners and turn handles to a safe position where they can not be knocked or grabbed.

IMPORTANT: Make sure the gas hob control knobs are all in the off position when not in use.

IMPORTANT: If you do not intend to use your gas hob for a long period of time turn off the gas and electric supply to the gas hob.

CAUTION: Using gas cooking appliances results in the production of heat, moisture and the products of combustion. Ensure that the room where your gas hob is installed is well ventilated particularly while the gas hob is in use. Keep natural ventilation holes open or install a mechanical ventilation device (extractor hood) Prolonged intensive use of your gas hob may call for additional ventilation (by opening a window) or by increasing the level of mechanical ventilation where present.

GENERAL SAFETY WARNINGS

IMPORTANT: This appliance has been designed for non-professional, domestic use only. Do not use this gas hob for commercial use or any other application e.g. room heating.

WARNING: Danger of fire: do not store flammable items on or near the cooking surfaces or inside the oven.

IMPORTANT: Your appliance is produced in accordance with all applicable local and international standards and regulations.

IMPORTANT: Maintenance and repair work must only be performed by authorised service technicians. Installation and repair work that is carried out by unauthorised technicians is dangerous and could invalidate your guarantee.

IMPORTANT: Do not hang towels, dishcloths or clothes from the hob or its controls.

CLEANING AND MAINTENANCE

IMPORTANT: Always turn the appliance off before operations such as cleaning or maintenance.

IMPORTANT: Do not remove the control knobs to clean the control panel.

WARNING: Do not use harsh abrasive cleaners or sharp metal scrapers to clean the glass since they can scratch the surface, which may result in shattering of the glass.

TO MAINTAIN THE EFFICIENCY AND SAFETY OF YOUR APPLIANCE, WE RECOMMEND YOU ALWAYS USE OUR AUTHORISED SERVICE AGENTS AND ORIGINAL SPARE PARTS.

**FOR ASSISTANCE CALL BUSH
PRODUCT SUPPORT 01759 487838.**

Getting to know your Built-in Gas Hob

2



Getting to know your Built in Gas Hob

You'll be up and running in no time

Ready? Let's begin...

Please read these instructions carefully. They contain important information which will help you get the best from your Built-in Gas Hob and ensure safe and correct installation and operation.

If you require any further assistance, our technical experts are happy to help. For full details, refer to the product support section at the end of these instructions.

If you require any technical guidance or find that your product is not operating as intended, a simple solution can often be found in the **Troubleshooting** section of these instructions.

Getting to know your Built in Gas Hob

You'll be up and running in no time



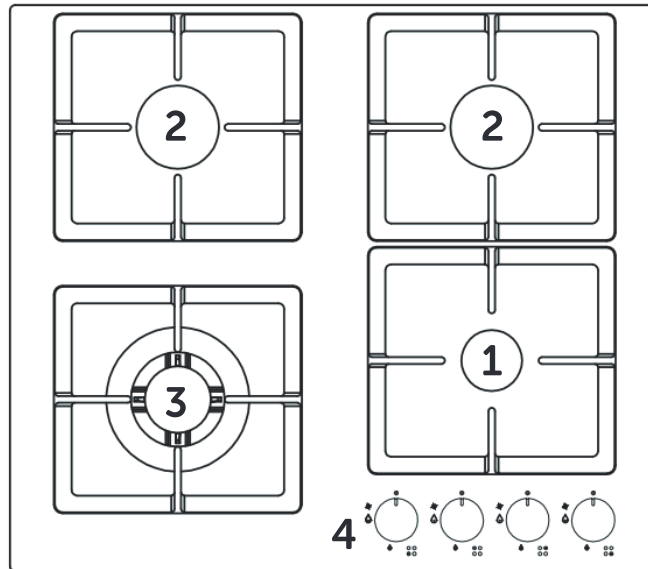

Overview



1. Auxiliary Burner
2. Semi-rapid Burners
3. Triple Burner
4. Burner Control Knobs

Knob Symbols

 All operating positions must be set between the maximum and minimum flow settings, and never between the maximum setting and the closed position.

	Off - No gas flow
 	On –Maximum gas flow
	Minimum gas flow

Getting to know your Built in Gas Hob

You'll be up and running in no time

Placement of Burner Heads and Caps

For all burners:

- Place a burner cap on each burner head (see Figure 1), matching the cap size to the head size. The cap for each burner has an inner locating ring which centers the cap correctly on the burner head. Be sure that all the burner caps and burner heads are correctly placed BEFORE using your appliance.

- Make sure each burner cap is properly aligned and level (see Figure 2).

- **⚠** Turn the burner on to determine if it will light. If the burner does not light, contact a qualified service center. Do not service the sealed burner yourself.

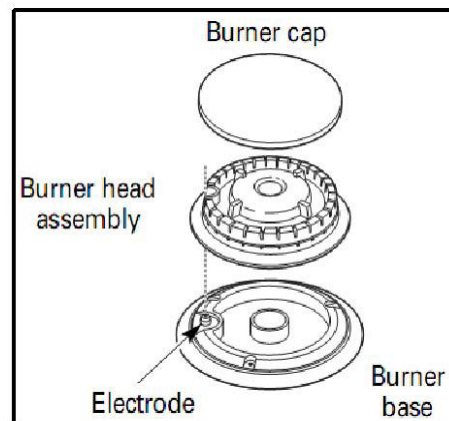

Figure 1

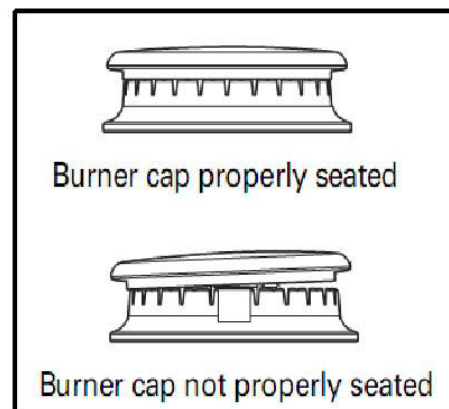

Figure 2

Surface Cooking Utensils

For lower gas consumption and better efficiency: Use only flat-bottomed pans of dimensions suitable for the burners. Check for flatness by rotating a ruler across the bottom of the pan. There should be no gaps between the pan and ruler. As soon as a liquid comes to a boil take care to turn the flame down to a level that will just keep it simmering.

Specialty pans (lobster pots and pressure cookers) may be used but must conform to the recommended cookware requirements.

If you require any technical guidance or find that your product is not operating as intended, a simple solution can often be found in the **Troubleshooting** section of these instructions,

Installing your Built-in Gas Hob

3



Installing your Built-in Gas Hob

Bringing it all together

Advance Preparation

⚠ This appliance must only be installed and used in rooms with permanent ventilation to local standards

Installation of the appliance and its connection to the electrical mains must only be carried out by QUALIFIED PROFESSIONALS.

Before installation, it is important to check that the appliance is DISCONNECTED from the electrical mains.

Positioning the Hob

It is recommended that the hob be installed in a worktop with a minimum thickness of 38 mm and depth of 600 mm. The cut-out dimensions and the recommended minimum clearances from the hob to nearby surfaces are shown in (Fig. 3.1) and (Fig. 3.2).

NOTE: If installing the hob over a standard cabinet, you may have to remove part of the cabinet panels to allow the unit to fit correctly.

NOTE: Gap between the cut-out and back of the wall **MUST** be 60 mm **Fig. 3.1**.

If installing a built-in oven directly under the hob, a minimum thickness of 38 mm worktop is required and **must have an air gap of 10 mm** between the oven and the bottom of the hob (**Fig. 3.2**).

If no built-in oven is installed underneath, and If the worktop surface used has less than a 38 mm is used a **10 mm air gap is still required (Fig. 3.2)**.

⚠ **There must be a minimum air gap of 10 mm under the hob. Failure to maintain a suitable clearance may impair the performance of the hob (Fig. 3.2).**

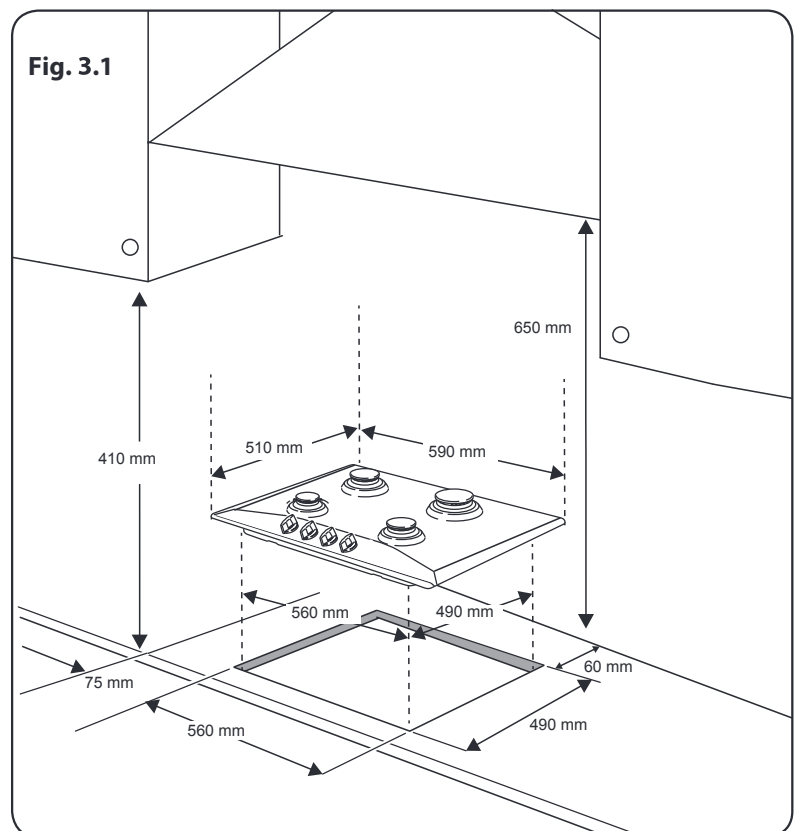

Installing your Built-in Gas Hob

Bringing it all together

NOTE: If the built-in hob is being installed directly above a built-in oven, an additional spacer (not supplied) may be required to maintain a **clearance of 10 mm** between the underside of the built-in hob and the top of the built-in oven **Fig. 3.3**.

Any hob hood should be installed in accordance with the hood manufacturer's instructions.

Any splashback must be fitted in accordance with the manufacturers instructions. Allowance should be made for the additional height of the flue trim, which is fitted to the cooker hob.

Surfaces of furniture and walls at the sides and rear of the hob should be heat, splash and steam resistant. Certain types of vinyl or laminate kitchen furniture are particularly prone to heat damage and discolouration.

We cannot accept responsibility for damage caused by normal use of the hob to any material that de-laminates or discolours at temperatures less than 65°C above room temperature.

For safety reasons curtains must not be fitted immediately behind the hotplate.

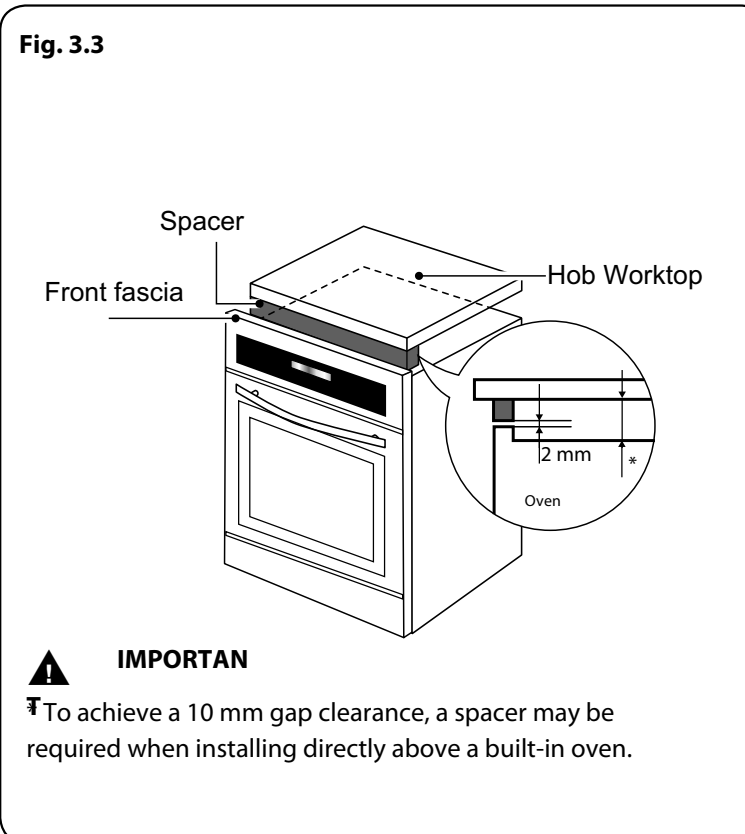
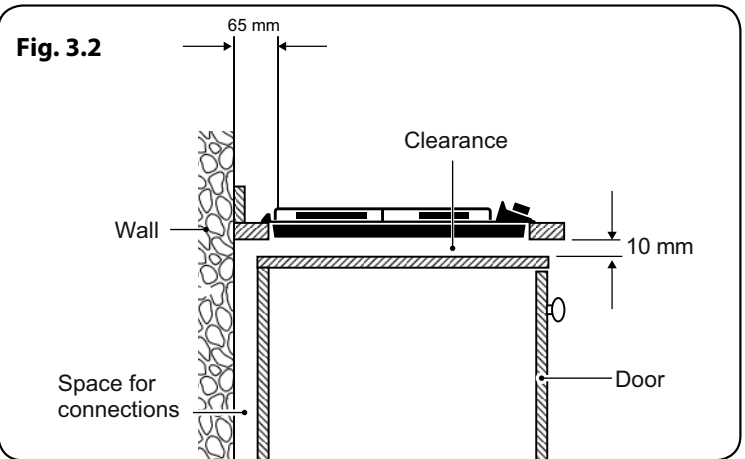

Installing your Built-in Gas Hob

Bringing it all together

Fixing the seal to the back of the hob

The hob must be sealed to the work surface to prevent liquid from entering into the cabinet. A tape seal is supplied with the hob. Refer to Fig. 3.4.

1. Turn the hob over and place in on a secure, level surface.
2. Spread the longer seal "A" around the inner left, rear and right sides.
3. With a cutter or scissors cut the excess seal and retain for next use.
4. Spread the seal "B" around the left, front and right outer edges of the cooktop.
5. Spread the seal "C" along the rear edge of the cooktop. Making sure that the beginning and the end overlap at the seal "B".

Fastening the Installation Brackets

Each cooktop is provided with an installation kit including brackets and screws for fastening the top to fixture panels from 20 to 40 mm thick. Refer to Fig. 3.4.

1. Turn the cooktop upside down and fasten the brackets "F" and "R" to the appropriate socket holes, without tightening the screws for the moment.
2. Make sure that the brackets are fastened.

Installing the Hob

1. Turn the hob back the right way up and position it in the worktop cut-out.
2. Insert the cooktop into the hole and position it correctly.
3. Adjust the position of the brackets "F" and "R" and tighten the "Rear Screw" and "Front Screw" to lock the cooktop firmly in position (Fig. 3.5).
4. With a sharp cutter or trimmer knife trim the excess sealing material around the edge of the cooktop. **Take care not to damage the workbench.**

If the surface that the hob is to be fitted is tiled, or is not reasonably smooth, additional sealing with a waterproof silicone sealant may be required.

If you require any technical guidance or find that your product is not operating as intended, a simple solution can often be found in the **Troubleshooting** section of these instructions,

Installing your Built-in Gas Hob

Bringing it all together

The picture is for reference only

Fig. 3.4

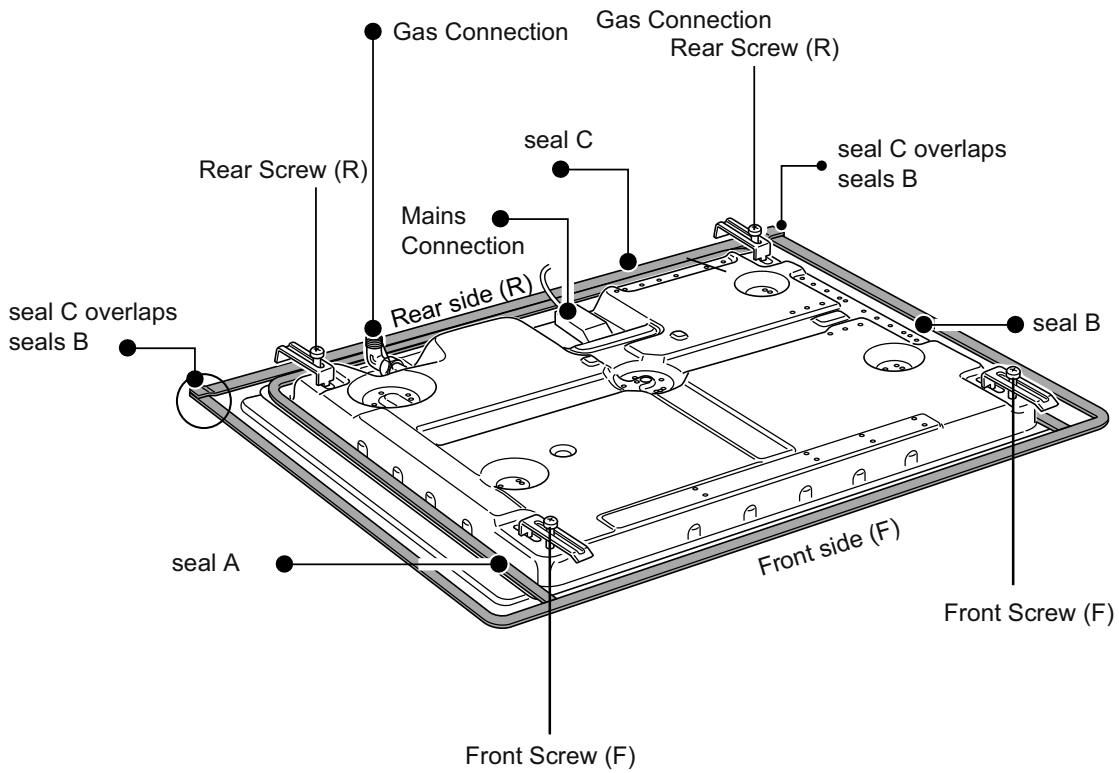
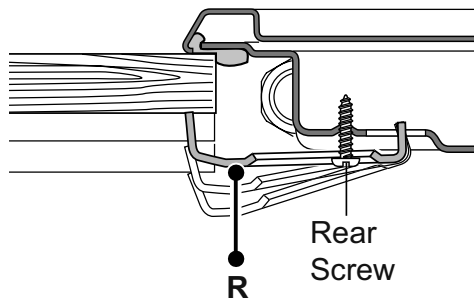
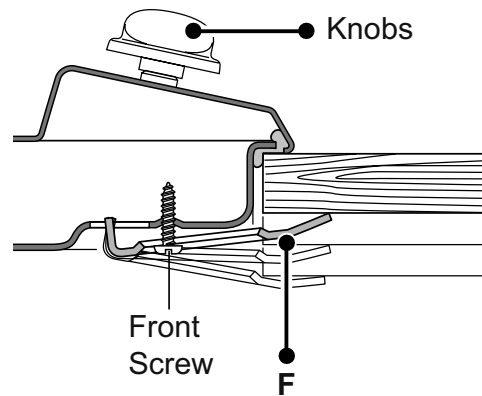

Fig. 3.5

Rear side



Front side



Installing your Built-in Gas Hob

Bringing it all together

Gas Conversion (NG to U-LPG)

Converting to a different gas type

CONVERSION TO A DIFFERENT GAS TYPE MUST BE CARRIED OUT BY A SUITABLY QUALIFIED GAS SAFE REGISTERED INSTALLER

Changing the jets

1. Remove pan supports, burner heads and caps.
2. Use a size 7 socket wrench to unscrew and remove the jets, replacing them with those supplied in the conversion kit. Ensure you use the correct jet for the corresponding burner.
3. Reassemble the burner heads, caps and pan supports.
4. Fit the Gas type label supplied in the conversion kit next to the gas connection point and remove the existing label.



Setting the minimum level

1. Light one of the burners and turn the tap to minimum flame.
2. Remove the corresponding control knob.
3. Use a thin blade screwdriver to turn the by-pass screw located above left of the gas valve shaft. Turn the by-pass screw fully clockwise. The result should be a small, stable flame which is uniform around the entire burner ring. If not, turn the by-pass screw anti-clockwise until satisfied with the flame.
4. Check that the burner does not go out when the tap is turned quickly from the maximum to the minimum position.
5. Repeat for each burner.



Accessories

1. Bracket*4
2. Screw*4
3. Seal*1
4. LPG Nozzel* 4

1



2



3



4



If you require any technical guidance or find that your product is not operating as intended, a simple solution can often be found in the **Troubleshooting** section of these instructions,

Installing your Built-in Gas Hob

Bringing it all together

Electrical Connection

Before making the connection, make sure that:

- 1) The safety circuit-breaker and the electrical system are able to with stand the load of the appliance.
- 2) The power supply system has a ground connection in good working order in accordance with the regulations in force.
- 3) The electrical socket is easily accessible with the appliance installed. In all cases, the power supply lead must be positioned so that it does not reach a temperature 50°C above the room temperature at any point.
- 4) If installed above a built-in oven, the cooktop cable must not touch the oven below.

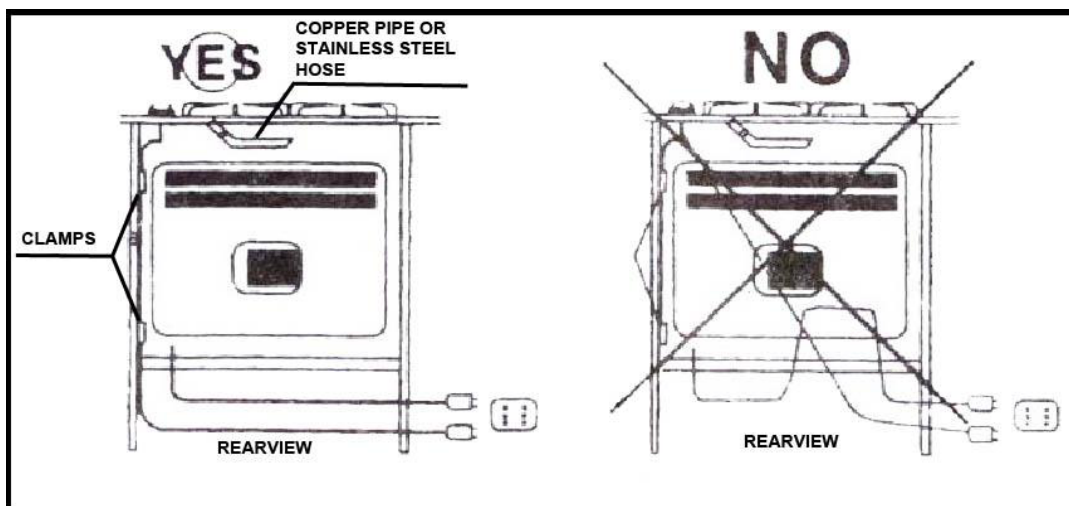

Figure 4

Replacing the power supply lead

If the lead has to be replaced, only HO5RR-F or HO5RN-F type cables suitable for the load and the operating temperature must be used. In addition, the yellow/green earth wire must be about 2 cm longer than the live and neutral wires.

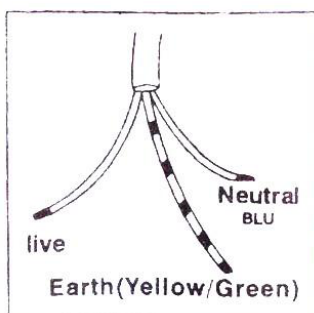

Figure 5

or online at www.bush-support.com If you still require further assistance, call one of our experts on 01759 487838.

Using your Built-in Gas Hob



Using your Built-in Gas Hob

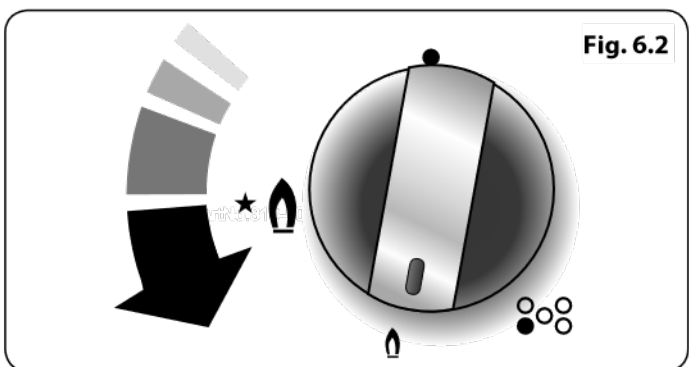
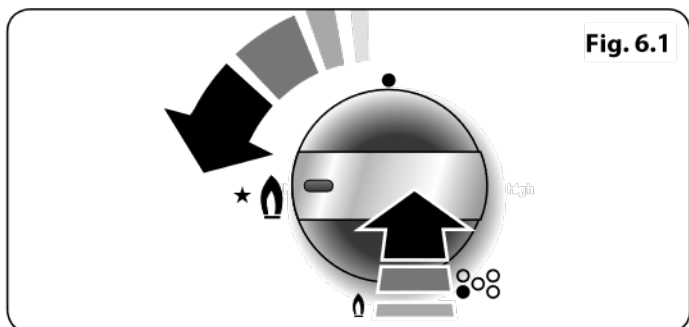

Getting the most from your appliance

Controls



Instructions for use (gas hob burners)

The symbols on the control knobs mean the following:

-  No gas flow or 'Off'
-  Maximum gas flow or 'high' flame and lighting position
-  Minimum gas flow or 'low' flame

All operating positions must be set between the maximum and minimum flow settings, and never between the maximum setting and the closed position.

Gas Burner Components

- A Burner cap
- B Burner Head
- C Burner Bowl
- D Thermocouple (where fitted)
- E Electrode

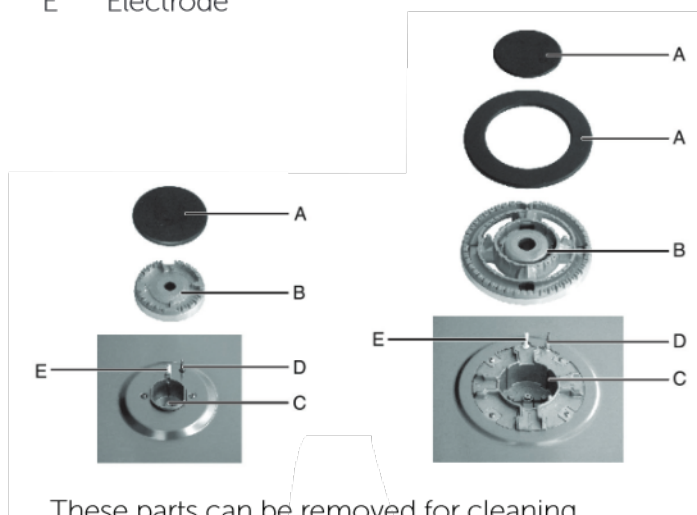

If you require any technical guidance or find that your product is not operating as intended, a simple solution can often be found in the **Troubleshooting** section of these instructions,

Using your Built-in Gas Hob

Getting the most from your appliance

To light the gas burners

To light the burner, press the control knob fully down and hold the knob down before rotating anti clockwise to the High Flame position. The ignition device is integrated into the control knob and is automatically activated by pushing down on the control knob.

After lighting the flame, keep the knob pressed for about 10 seconds: this time is necessary to heat up the thermocouple and activate the safety valve, which would otherwise cut off the gas flow. This step only applies where flame failure device is fitted.

In the instance of a power failure, place a lit match near the burner and proceed as described above. If the flame does not light after the first attempt, wait 5 minutes for the gas to dissipate before attempting to re-light the burner.

Once lit, check that the flame is even and turn the control knob to adjust the flame as required. If the flame is uneven, check that the 'burner head/skirt' and 'burner cap' are correctly positioned. To turn off the flame, turn the control knob clockwise to the off position. Before removing pots or pans from the burners, always turn off the flame.

For correct use of the gas hob

For lower gas consumption and better efficiency, use only flat-bottomed pan of dimensions suitable for the burners, as shown in the table below. Also as soon as a liquid comes to the boil take care to turn the flame down to a level that will just keep it boiling.

The use of pans in excess of the maximum diameter recommended in the table above can result in over heating/discoloration of hob surface. During cooking processes involving fats and oils, watch your foods carefully because these substances may catch fire if overheated.

Burner	Min. Diameter	Max. Diameter
Large (rapid)	180mm	220mm
Medium (semi-rapid)	120mm	200mm
Small (Auxiliary)	80mm	160mm
Triple Flame (Wok)	220mm	260mm

Care and maintenance

5



Care and maintenance

Looking after your appliance

Cleaning

WARNING! Isolate the power supply to the cooker and make sure that the oven is cool.

Before cleaning your oven or performing maintenance, make sure that the cooking mode selection knob and the cooking temperature selection knob is set to 'OFF'. To extend the life of your oven, it must be cleaned frequently.

The inside of the oven should preferably be cleaned immediately after use, when it is still warm (but not hot), with warm water and soap. The soap should be rinsed away and the interior dried thoroughly. Avoid using abrasive detergents, scourers, acidic cleaners such as lime scale remover, etc, as these could damage the enamel, and can result in development of rust and corrosion. If stains are particularly tough to remove, use cleaners specifically recommended to clean ovens and follow the instructions provided with the cleaner. **Never use steam cleaner for cleaning inside the oven.**

Do not clean using caustic creams, abrasive cleaning powders, thick wire wool or hard tools. Enamelled parts of the oven can be damaged if excess cleaning liquids are not immediately removed.

After cleaning the interior parts of the oven with a soapy cloth, rinse it and then dry thoroughly with a soft cloth.

Clean the glass surfaces with special glass cleaning agents.

Never use flammable agents like acid, thinner or petrol when cleaning your oven.

Do not clean your oven with a steam cleaner.

Do not wash any part of your oven in a dishwasher.

Burner Caps:

Periodically, the enamelled pan support, enamelled covers and burner heads must be washed with warm soapy water, rinsed and dried. After drying them thoroughly, place them back in their original positions on the burners

Enamelled Parts:

In order to keep enamelled parts as new, it is necessary to clean them frequently with mild warm soapy water and then dry with a cloth. Do not wash them while hot and never use abrasive powders or abrasive cleaning materials. Do not leave anything spilled onto enamelled parts for long periods of time.

Stainless Steel:

Stainless steel parts must be cleaned frequently with mildly warm soapy water and a soft sponge and then dried with a soft cloth. Do not use abrasive powders or abrasive cleaning materials. Do not leave anything spilled onto stainless steel parts for long periods of time.

Glass:

The glass should be regularly cleaned, always wipe clean immediately after each use once the residual heat warnings have switched off – DO NOT clean when hob is still hot. Smudges from pans with an aluminium bottom can be easily cleaned off with a cloth dampened in vinegar. Remove any burnt residues immediately after cooking, rinse with water and wipe dry with a clean cloth. Never use abrasive or corrosive detergents, cleaning powders, oven sprays, spot-removers, steel wool or scourers.

Care and maintenance

Looking after your appliance

Routine maintenance

Have the condition and efficiency of the gas pipe and the pressure regulator (if installed) checked periodically. If anomalies are found, do not repair components but have the faulty component replaced. To ensure good performance and safety, the gas regulator taps must be greased periodically.

Periodic lubrication of the taps and any other appliance service must only be carried out by Authorised Personnel.

Abnormal operation

Any of the following are considered to be abnormal operation and may require servicing:

- Yellow tipping of the burner flame.
- Sooting up of cooking utensils.
- Burners not igniting properly.
- Burners failing to remain alight.
- Burners extinguished by cupboard doors.
- Gas valves, which are difficult to turn.

In case the appliance fails to operate correctly, contact our Support Team on 01759 487838.

Care and maintenance

Looking after your appliance

Technical Specification

	BGOGH60
Power Supply	220-240V~50Hz
No Of The Gas Burner	4
Product Size (W x D x H)mm	590 x 510 x 58
Net Weight (kg)	14.6
Out Put-Triple Ring Burner(kW)	3.8
Out Put-Semi-rapid Burner(kW)	1.75
Out Put-Auxiliary Burner(kW)	1

We apologise for any inconvenience caused by minor inconsistencies within these instructions that may occur due to product improvements and development

All images and drawings are for illustration purposes only.

If you require any technical guidance or find that your product is not operating as intended, a simple solution can often be found in the **Troubleshooting** section of these instructions.

Product support

6



Product support

Help is always at hand

Troubleshooting

1. If no electrical functions appear to work, check the cooker isolation switch has not been turned off also check the fuse in the switch and the circuit breaker in you consumer unit
2. After replacing the fuse or resetting the circuit breaker turn on individual parts of your cooker one at a time to check function
3. **DO NOT ATTEMPT TO REPAIR THIS COOKER YOURSELF. CALL BUSH PRODUCT SUPPORT ON 01759 487838 OR CONSULT A GAS SAFE REGISTERED INSTALLER**

Problem	Possible Cause	Solution
Erratic flames on the Gas Hob	Debris in the Gas burners or jets.	Please contact the product support team for assistance from a engineer.
Strong smell of Gas from hob	Possible Gas leak	Turn off ALL gas supply, open windows and doors for immediate ventilation. Contact product support team for an engineer service call.
The hob burners do not operate correctly	Check if the burner parts are correctly assembled (especially after cleaning).	The gas supply pressure may be too low/high. For appliances working with bottled LPG, the LPG cylinder may be depleted.
Ignition not working properly	Possible fault with the igniter or ignition system	Call product support team for assistance and possible engineer visit.

If you require any technical guidance or find that your product is not operating as intended, a simple solution can often be found in the **Troubleshooting** section of these instructions.

Product support

Help is always at hand

Help and assistance

If you require any technical guidance or find that your Hob is not operating as intended, a simple solution can often be found in the **Troubleshooting** section of these instructions or online at **www.bush-support.com**

If you still require further assistance, call one of our experts on **01759 487838***. To help give us give you a fast and efficient service please have the following information ready:

Model Ref.	<input type="text"/>	You can find these on the rating plate - a small information panel (usually a sticker or metal plate) on the rear of your appliance
Serial number	<input type="text"/>	
Date of purchase	<input type="text"/>	This will be shown on your receipt

Local call rates applies*

Lines open 09:00- 17:30 Monday to Friday.

*Calls to Bush enquiry lines may attract a charge and set up fee from residential lines depending on your call plan/tariff. Mobile and other providers costs may vary, see www.bt.com/pricing for details.

For Security and training purposes, telephone calls to and from customer service centres maybe recorded and monitored. Calls from Republic of Ireland will attract international call charges.

or online at **www.bush-support.com** If you still require further assistance, call one of our experts on **01759 487838**

Product support

Help is always at hand

Declaration of conformance to product standards

This appliance conforms to all relevant standards applicable to domestic appliances sold in the UK

Disposal



This appliance/fitting is marked according to the European directive 2012/19/EU on Waste Electrical and Electronic Equipment (WEEE).

By ensuring this product is disposed of correctly, you will help prevent potential negative consequences for the environment and human health, which could otherwise be caused by inappropriate waste handling of this product.

The symbol on the product, or on the documents accompanying the product, the **crossed out wheelie bin** symbol, indicates that this appliance/fitting may not be treated as household waste. Instead it shall be handed over to the applicable collection point for the recycling of electrical and electronic equipment.

Disposal must be carried out in accordance with local environmental regulations for waste disposal.

For more detailed information about treatment, recovery and recycling of this product, please contact your local authority, your household waste disposal service or the retailer where you purchased the product.



Call us now and activate your 12 month guarantee

Thank you for choosing Bush. Your new product is guaranteed against faults and breakdowns for 12 months. Don't forget to register it with us today so we can provide you with our best possible after-sales service and useful updates.

www.bushregistration.co.uk

FREEPHONE*

0800 597 8548

Lines open 09:00- 17:30 Monday to Friday.

Your Bush Guarantee

This product is guaranteed for twelve months from the date of original purchase. Any defect that arises due to faulty materials or workmanship will be repaired free of charge (or if applicable the product will be replaced or the purchase price refunded) where possible during this period by the dealer from who your purchased the unit.

The guarantee is subject to the following provisions:

- The guarantee does not cover accidental damage, misuse, cabinet parts, knobs or consumable items.
- The product must be correctly installed and operated in accordance with the instructions contained in the manual.
- It must be used solely for domestic purposes. The guarantee will be rendered invalid if the product is re-sold or has been damaged by inexpert repair.
- Specifications are subject to change without notice.
- Bush disclaim any liability for loss or damage arising from the breakdown of the product.
- This guarantee is in addition to and does not diminish your statutory or legal rights.

Important Data Protection Information

To find out how we and Domestic & General Insurance Plc use your data please refer to the guarantee registration material or visit www.bushregistrations.co.uk

Guarantor: Argos Limited - 489 - 499 Avebury Blvd. - Milton Keynes - MK9 2NW

or online at www.bush-support.com If you still require further assistance, call one of our experts on **01759 487838**

EU Declaration of Conformity

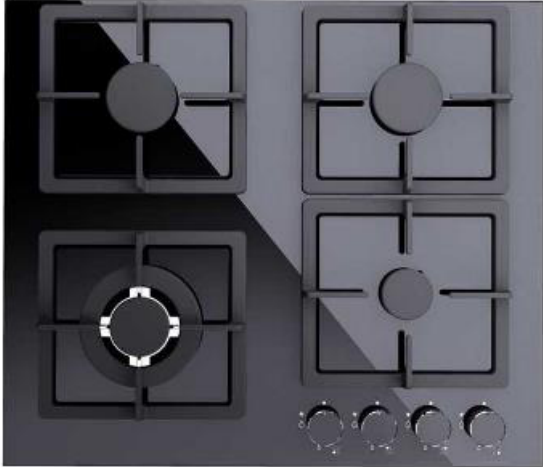
Section 1	
Product	60cm 4 burner gas on glass hob
Model/type	BGOGH60
Catalogue number	1237669
Section 2	
Manufacturer Name & Address	<input type="checkbox"/> Sainsbury's Supermarket Ltd. 33 Holborn, London, EC1N 2HT <input checked="" type="checkbox"/> Argos Limited. <input type="checkbox"/> Habitat Retail Limited. 489-499 Avebury Boulevard, Saxon Gate West, Milton Keynes, Buckinghamshire, MK9 2NW
EU Authorised Representative	<input type="checkbox"/> Sainsburys (NI) Ltd Sainsbury's Forestside Shopping Centre, Upper Galwally, Belfast, United Kingdom, BT8 6FX. <input checked="" type="checkbox"/> Argos (N.I.) Ltd Forestside Shopping Centre, Upper Galwally, Belfast, United Kingdom, BT8 6FX.
Section 3	
This declaration is issued under the sole responsibility of the manufacturer.	
Section 4	
Product Image	
Section 5	
We hereby certify that the product stipulated above complies with all the relevant provisions of the following EC new approach directive/s:	
<ul style="list-style-type: none">• 2014/30/EU Electromagnetic Compatibility (EMC)• 2014/35/EU Low Voltage Directive (LVD)• 2016/426/EU Gas Appliances Regulation (GAR)• 2011/65/EU Restriction of Hazardous Substances (RoHS)• 2009/125/EC Eco-design of Energy related Products (ErP)	
Section 6 & 7	
Conformity is shown by compliance with the applicable requirements of the following harmonised standards:	

Applicable Harmonized Standards (Standard reference, date and amendments) <i>e.g. EN71-1:2014</i>	Notified Body (where applicable provide name and address of notified body) <i>e.g. Bureau Veritas CPS Warrington, UK</i>	Title <i>e.g. Safety of Toy: physical & mechanical</i>
EN55014-1 EN55014-2 EN61000-3-2 +A1 EN61000-3-3 +A1 +A2	Dekra	Electromagnetic Compatibility (EMC)
EN60335-1:2010 EN60335-1:2010/AMD1:2013 EN60335-1:2010/AMD2:2016 EN60335-2-102:2017 NL-76766	Dekra	Low Voltage Directive (LVD)
EN30-1-1:2008 +A2:2010 +A3:2013 EN30-2-1:2015	Kiwa	Gas Appliances Regulation (GAR)
2009/125/EC	Kiwa	Eco-design of Energy related Products (ErP)
2022/65/EU, 2015/863	Waltek	Restriction of Hazardous Substances (RoHS)

Section 8 – To be completed by Sainsbury's Argos / Habitat

Signed for and on behalf of:	Argos Limited.
Date of issue:	6/4/2023
Name:	Lisa Hollidge
Position:	Director of Commercial Operations & Development
Signature:	

GB Declaration of Conformity

Section 1	
Product	60cm 4 burner gas on glass hob
Model/type	BGOGH60
Catalogue number	1237669
Section 2	
Manufacturer Name & Address	<input type="checkbox"/> Sainsbury's Supermarket Ltd. 33 Holborn, London, EC1N 2HT <input checked="" type="checkbox"/> Argos Limited. <input type="checkbox"/> Habitat Retail Limited. 489-499 Avebury Boulevard, Saxon Gate West, Milton Keynes, Buckinghamshire, MK9 2NW
Section 3	
This declaration is issued under the sole responsibility of the manufacturer.	
Section 4 Product Image	
Section 5	
<p>We hereby certify that the product stipulated above complies with all the relevant provisions of the following EC new approach directive/s:</p> <ul style="list-style-type: none">• Electromagnetic Compatibility Regulations 2016• Electrical Equipment (Safety) Regulations 2016• Gas Appliances (Product Safety and Metrology etc (Amendment etc) (EU Exit) Regulations 2019)• The Ecodesign for Energy-Related Products and Energy Information (Amendment) (EU Exit) Regulations 2019• The Restriction of the Use of Certain Hazardous Substances in Electrical and Electronic Equipment Regulations 2012	

Section 6 & 7

Conformity is shown by compliance with the applicable requirements of the following harmonised standards:

Applicable Harmonized Standards (Standard reference, date and amendments) <i>e.g. EN71-1:2014</i>	Notified Body (where applicable provide name and address of notified body) <i>e.g. Bureau Veritas CPS Warrington, UK</i>	Title <i>e.g. Safety of Toy: physical & mechanical</i>
EN55014-1 EN55014-2 EN61000-3-2 +A1 EN61000-3-3 +A1 +A2	Dekra	Electromagnetic Compatibility (EMC)
EN60335-1:2010 EN60335-1:2010/AMD1:2013 EN60335-1:2010/AMD2:2016 EN60335-2-102:2017 NL-76766	Dekra	Low Voltage Directive (LVD)
EN30-1-1:2008 +A2:2010 +A3:2013 EN30-2-1:2015	Kiwa	Gas Appliances Regulation (GAR)
2009/125/EC	KIWA	Eco-design of Energy related Products (ErP)
2022/65/EU, 2015/863	Waltek	Restriction of Hazardous Substances (RoHS)

Section 8 – To be completed by Sainsbury's Argos / Habitat

Signed for and on behalf of:	Argos Limited.
Date of issue:	6/4/2023
Name:	Lisa Hollidge
Position:	Director of Commercial Operations & Development
Signature:	

BUSH



Contact:

www.bush-support.com

Helpline: 01759 487838